

Christoph Rauscher
(Volker Janssen, Roland Minihold)

Fundamentals of Spectrum Analysis

© Rohde & Schwarz GmbH & Co. KG
Mühldorfstrasse 15
81671 München
Germany
www.rohde-schwarz.com

First edition 2001
Printed in Germany

This book may only be obtained from the Rohde & Schwarz sales offices and Munich headquarters. Parts of this publication may be reproduced by photocopying for use as teaching material. Any further use, in particular digital recording and processing, shall not be permitted.

PW 0002.6635

Table of contents

1	INTRODUCTION	9
2	SIGNALS	10
2.1	Signals displayed in time domain	10
2.2	Relationship between time and frequency domain	11
3	CONFIGURATION AND CONTROL ELEMENTS OF A SPECTRUM ANALYZER	19
3.1	Fourier analyzer (FFT analyzer)	19
3.2	Analyzers operating according to the heterodyne principle	29
3.3	Main setting parameters	32
4	PRACTICAL REALIZATION OF AN ANALYZER OPERATING ON THE HETERODYNE PRINCIPLE	34
4.1	RF input section (frontend)	34
4.2	IF signal processing	46
4.3	Determination of video voltage and video filters	58
4.4	Detectors	64
4.5	Trace processing	77
4.6	Parameter dependencies	80
4.6.1	Sweep time, span, resolution and video bandwidths	80
4.6.2	Reference level and RF attenuation	84
4.6.3	Overdriving	90
5	PERFORMANCE FEATURES OF SPECTRUM ANALYZERS	100
5.1	Inherent noise	100
5.2	Nonlinearities	107
5.3	Phase noise (spectral purity)	119
5.4	1 dB compression point and maximum input level	125
5.5	Dynamic range	130
5.6	Immunity to interference	142
5.7	LO feedthrough	145
5.8	Filter characteristics	146
5.9	Frequency accuracy	147
5.10	Level measurement accuracy	148
5.10.1	Error components	149

5.10.2	Calculation of total measurement uncertainty	156
5.10.3	Error due to low signal-to-noise ratio	164
5.11	Sweep time and update rate	167
6	FREQUENT MEASUREMENTS AND ENHANCED FUNCTIONALITY	170
6.1	Phase noise measurements	170
6.1.1	Measurement procedure	170
6.1.2	Selection of resolution bandwidth	173
6.1.3	Dynamic range	175
6.2	Measurements on pulsed signals	180
6.2.1	Fundamentals	181
6.2.2	Line and envelope spectrum	186
6.2.3	Resolution filters for pulse measurements	191
6.2.4	Analyzer parameters	192
6.2.5	Pulse weighting in spurious signal measurements	194
6.2.5.1	Detectors, time constants	195
6.2.5.2	Measurement bandwidths	199
6.3	Channel and adjacent-channel power measurement	199
6.3.1	Introduction	199
6.3.2	Key parameters for adjacent-channel power measurement	202
6.3.3	Dynamic range in adjacent-channel power measurements	203
6.3.4	Methods for adjacent-channel power measurement using a spectrum analyzer	204
6.3.4.1	Integrated bandwidth method	204
6.3.4.2	Spectral power weighting with modulation filter (IS-136, TETRA, WCDMA)	208
6.3.4.3	Channel power measurement in time domain	210
6.3.4.4	Spectral measurements on TDMA systems	211
	MEASUREMENT TIPS	
	Measurements in 75 Ω system	35
	Measurement on signals with DC component	39
	Maximum sensitivity	106
	Identification of intermodulation products	117
	Improvement of input matching	155

REFERENCES	214
THE CURRENT SPECTRUM ANALYZER MODELS FROM ROHDE & SCHWARZ	216

1 INTRODUCTION

One of the most frequent measurement tasks in radiocommunications is the examination of signals in the frequency domain. Spectrum analyzers required for this purpose are therefore among the most versatile and widely used RF measuring instruments. Covering frequency ranges of up to 40 GHz and beyond, they are used in practically all applications of wireless and wired communication in development, production, installation and maintenance efforts. With the growth of mobile communications, parameters such as displayed average noise level, dynamic range and frequency range, and other exacting requirements regarding functionality and measurement speed come to the fore. Moreover, spectrum analyzers are also used for measurements in the time domain, such as measuring the transmitter output power of time multiplex systems as a function of time.

This book is intended to familiarize the uninitiated reader with the field of spectrum analysis. To understand complex measuring instruments it is useful to know the theoretical background of spectrum analysis. Even for the experienced user of spectrum analyzers it may be helpful to recall some background information in order to avoid measurement errors that are likely to be made in practice.

In addition to dealing with the fundamentals, this book provides an insight into typical applications such as phase noise and channel power measurements.

2 SIGNALS

2.1 Signals displayed in time domain

In the time domain the amplitude of electrical signals is plotted versus time - a display mode that is customary with oscilloscopes. To clearly illustrate these waveforms, it is advantageous to use vector projection. The relationship between the two display modes is shown in Fig. 2-1 by way of a simple sinusoidal signal.

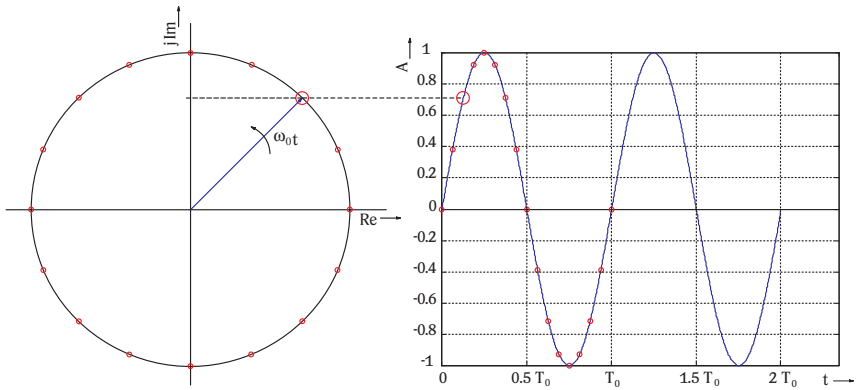

Fig. 2-1 Sinusoidal signal displayed by projecting a complex rotating vector on the imaginary axis

The amplitude plotted on the time axis corresponds to the vector projected on the imaginary axis (jIm). The angular frequency of the vector is obtained as:

$$\omega_0 = 2 \cdot \pi \cdot f_0 \quad \text{(Equation 2-1)}$$

where ω_0 = angular frequency, in s^{-1}
 f_0 = signal frequency, in Hz

A sinusoidal signal with $x(t) = A \cdot \sin(2 \cdot \pi \cdot f_0 \cdot t)$ can be described as $x(t) = A \cdot \text{Im} \left\{ e^{j2\pi f_0 t} \right\}$.

2.2 Relationship between time and frequency domain

Electrical signals may be examined in the time domain with the aid of an oscilloscope and in the frequency domain with the aid of a spectrum analyzer (see Fig. 2-2).

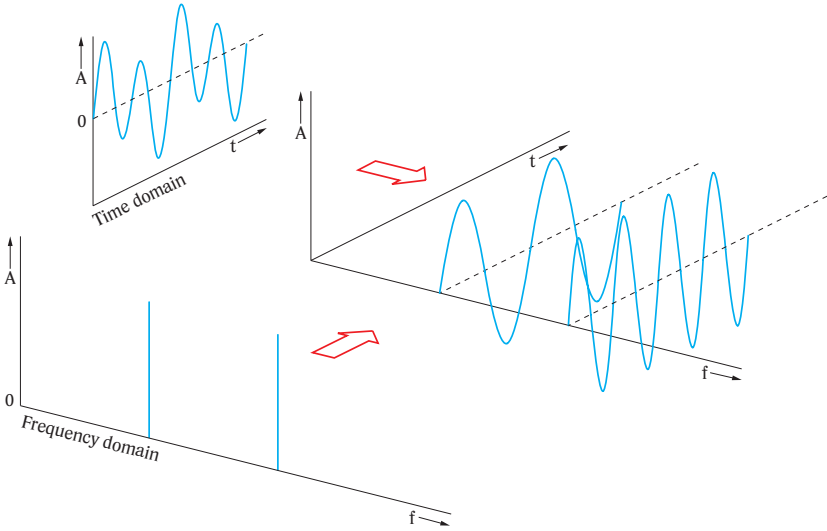

Fig. 2-2 Signals examined in time and frequency domain

The two display modes are related to each other by the Fourier transform (denoted F), so each signal variable in the time domain has a characteristic frequency spectrum. The following applies:

$$\underline{X}_f(f) = F\{x(t)\} = \int_{-\infty}^{+\infty} x(t) \cdot e^{-j2\pi ft} dt \quad (\text{Equation 2-2})$$

and

$$x(t) = F^{-1}\{\underline{X}_f(f)\} = \int_{-\infty}^{+\infty} \underline{X}_f(f) \cdot e^{j2\pi ft} df \quad (\text{Equation 2-3})$$

where

$F\{x(t)\}$	=	Fourier transform of $x(t)$
$F^{-1}\{\underline{X}(f)\}$	=	inverse Fourier transform of $\underline{X}(f)$
$x(t)$	=	signal in time domain
$\underline{X}_f(f)$	=	complex signal in frequency domain

To illustrate this relationship, only signals with a periodic response in the time domain will be examined first.

Periodic signals

According to the Fourier theorem, any signal that is periodic in the time domain can be derived from the sum of sine and cosine signals of different frequency and amplitude. Such a sum is referred to as a Fourier series. The following applies:

$$x(t) = \frac{A_0}{2} + \sum_{n=1}^{\infty} A_n \cdot \sin(n \cdot \omega_0 \cdot t) + \sum_{n=1}^{\infty} B_n \cdot \cos(n \cdot \omega_0 \cdot t) \quad (\text{Equation 2-4})$$

The Fourier coefficients A_0 , A_n and B_n depend on the waveform of signal $x(t)$ and can be calculated as follows:

$$A_0 = \frac{2}{T_0} \int_0^{T_0} x(t) dt \quad (\text{Equation 2-5})$$

$$A_n = \frac{2}{T_0} \int_0^{T_0} x(t) \cdot \sin(n \cdot \omega_0 \cdot t) dt \quad (\text{Equation 2-6})$$

$$B_n = \frac{2}{T_0} \int_0^{T_0} x(t) \cdot \cos(n \cdot \omega_0 \cdot t) dt \quad (\text{Equation 2-7})$$

where

$\frac{A_0}{2}$	=	DC component
$x(t)$	=	signal in time domain
n	=	order of harmonic oscillation
T_0	=	eriod
ω_0	=	angular frequency

Fig. 2-3b shows a rectangular signal approximated by a Fourier series. The individual components are shown in Fig. 2-3a. The greater the number of these components, the closer the signal approaches the ideal rectangular pulse.

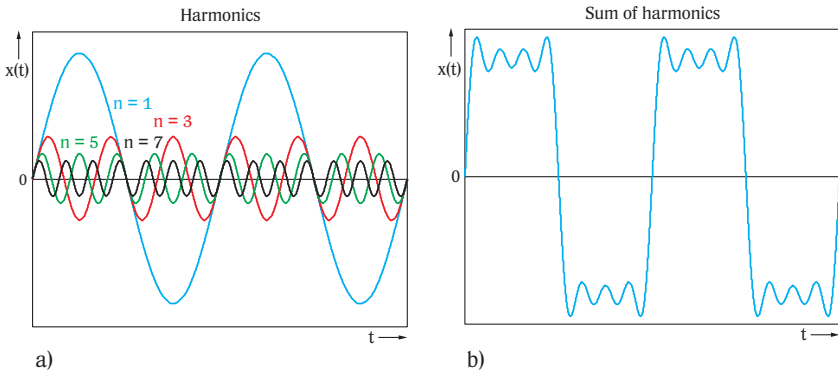

Fig. 2-3 Approximation of a rectangular signal by summation of various sinusoidal oscillations

In the case of a sine or cosine signal a closed-form solution can be found for Equation 2-2 so that the following relationships are obtained for the complex spectrum display:

$$F\{\sin(2 \cdot \pi \cdot f_0 \cdot t)\} = \frac{1}{j} \cdot \delta(f - f_0) = -j \cdot \delta(f - f_0) \quad \text{(Equation 2-8)}$$

and

$$F\{\cos(2 \cdot \pi \cdot f_0 \cdot t)\} = \delta(f - f_0) \quad \text{(Equation 2-9)}$$

where $\delta(f - f_0)$ is a Dirac function $\delta(f - f_0) = 1$ if $f - f_0 = 0$, and $f = f_0$
 $\delta(f - f_0) = 0$ otherwise

It can be seen that the frequency spectrum both of the sine and cosine signal consists of a single Dirac pulse at f_0 (see Fig. 2-5a). The Fourier transforms of the sine and cosine signal are identical in magnitude, so that the two signals exhibit an identical magnitude spectrum at the same frequency f_0 .

To calculate the frequency spectrum of a periodic signal whose time characteristic is described by a Fourier series according to Equation 2-4, each component of the series has to be transformed. Each of these elements leads to a Dirac pulse which is a discrete component in the frequency domain. Periodic signals therefore always exhibit discrete spectra which are also referred to as line spectra. Accordingly, the spectrum shown in Fig. 2-4 is obtained for the approximated rectangular signal of Fig. 2-3.

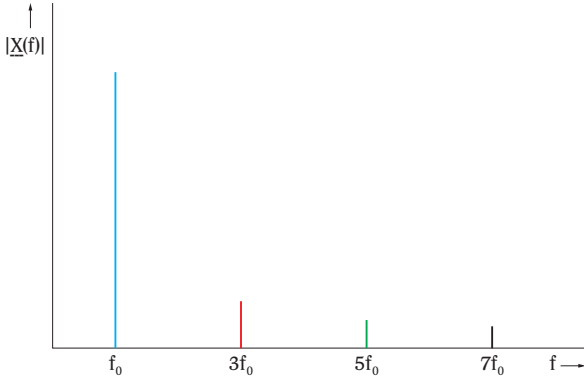

Fig. 2-4 Magnitude spectrum of approximated rectangular signal shown in Fig. 2-3

Fig. 2-5 shows some further examples of periodic signals in the time and frequency domain

Non-periodic signals

Signals with a non-periodic characteristic in the time domain cannot be described by a Fourier series. Therefore the frequency spectrum of such signals is not composed of discrete spectral components. Non-periodic signals exhibit a continuous frequency spectrum with a frequency-dependent spectral density. The signal in the frequency domain is calculated by means of a Fourier transform (Equation 2-2).

Similar to the sine and cosine signals, a closed-form solution can be found for Equation 2-2 for many signals. Tables with such transform pairs can be found in [2-1].

For signals with random characteristics in the time domain, such as noise or random bit sequences, a closed-form solution is rarely found. The frequency spectrum can in this case be determined more easily by a numeric solution of Equation 2-2.

Fig. 2-6 shows some non-periodic signals in the time and frequency domain.

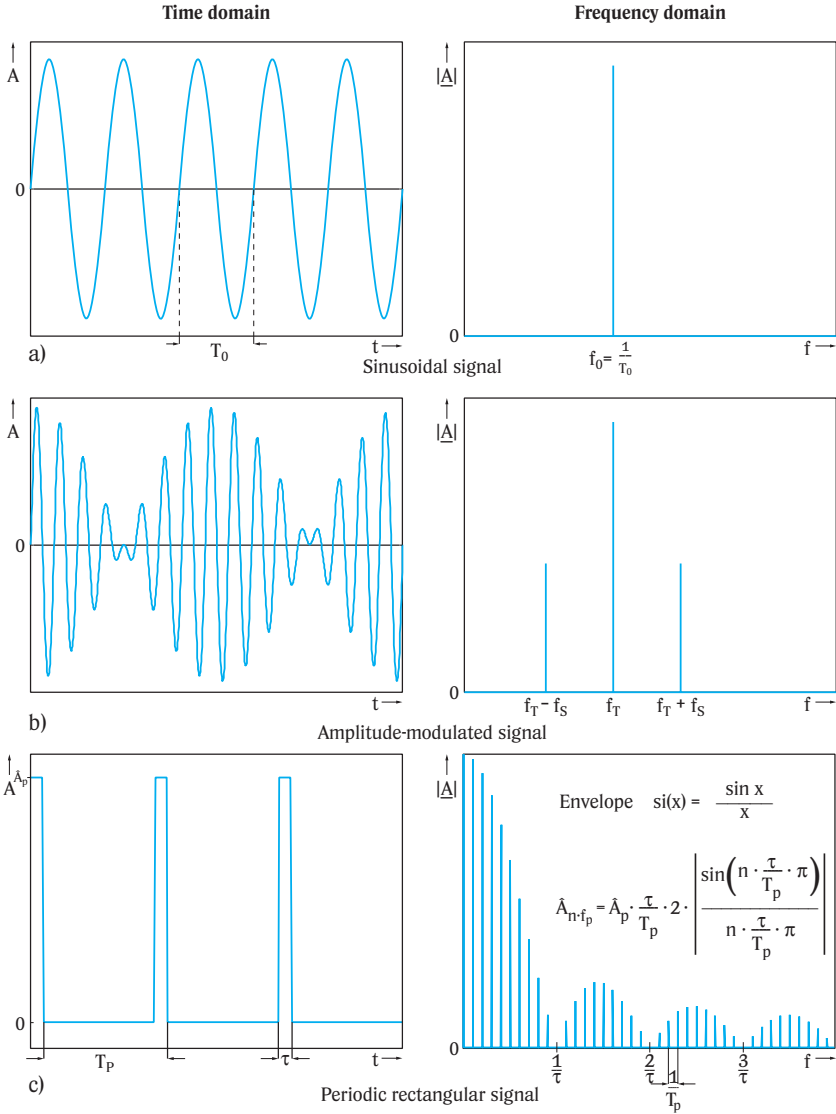

Fig. 2-5 Periodic signals in time and frequency domain (magnitude spectra)

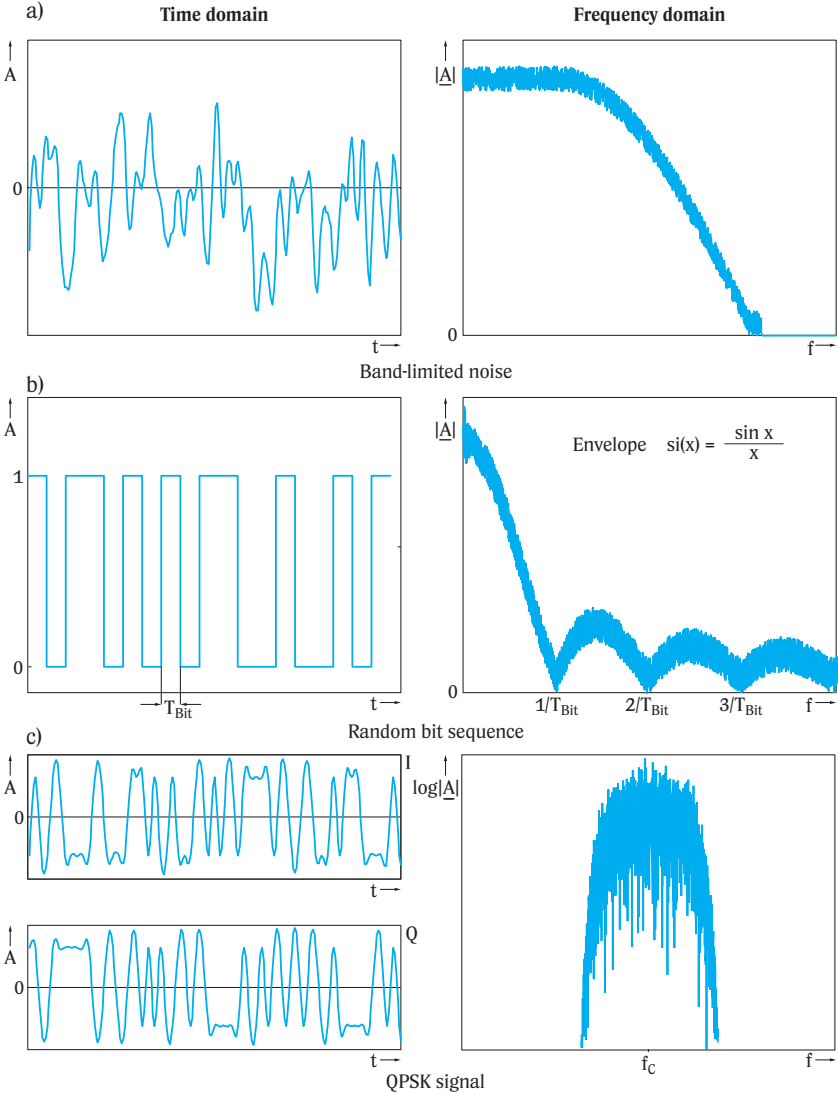

Fig. 2-6 Non-periodic signals in time and frequency domain

Depending on the measurement to be performed, examination may be useful either in the time or in the frequency domain. Digital data transmission jitter measurements, for example, require an oscilloscope. For determining the harmonic content, it is more useful to examine the signal in the frequency domain:

The signal shown in Fig. 2-7 seems to be a purely sinusoidal signal with a frequency of 20 MHz. Based on the above considerations one would expect the frequency spectrum to consist of a single component at 20 MHz.

On examining the signal in the frequency domain with the aid of a spectrum analyzer, however, it becomes evident that the fundamental (1st order harmonic) is superimposed by several higher-order harmonics (Fig. 2-8). This information cannot be easily obtained by examining the signal in the time domain. A practical quantitative assessment of the higher-order harmonics is not feasible. It is much easier to examine the short-term stability of frequency and amplitude of a sinusoidal signal in the frequency domain compared to the time domain (see also chapter 6.1 Phase noise measurement).

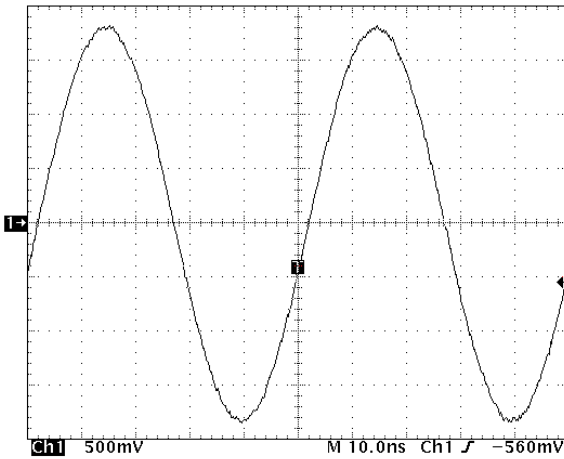

Fig. 2-7 Sinusoidal signal ($f = 20$ MHz) examined on oscilloscope

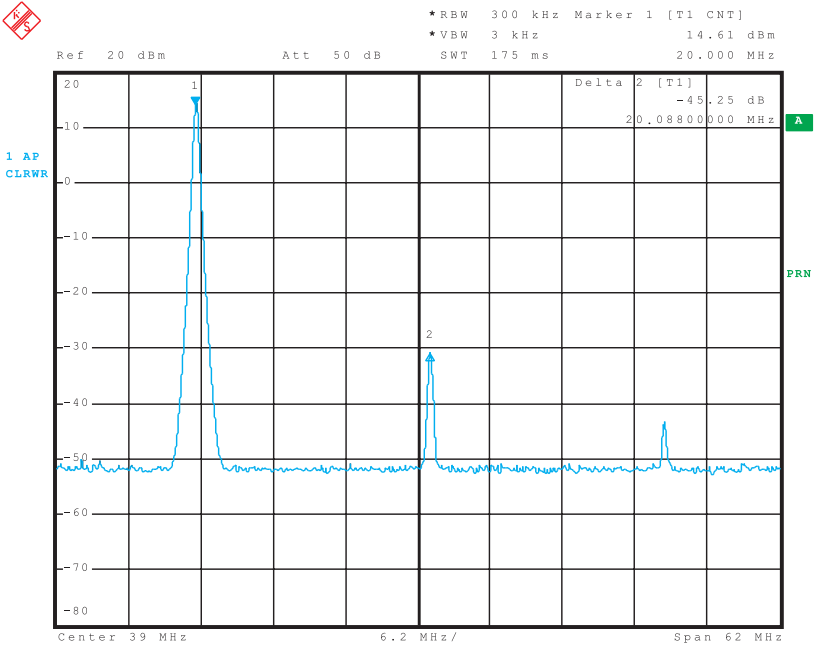

Fig. 2-8 sinusoidal signal of Fig. 2-7 examined in the frequency domain with the aid of a spectrum analyzer

In practice, the Fourier transform is made with the aid of digital signal processing, so the signal to be analyzed has to be sampled by an analog-digital converter and quantized in amplitude. By way of sampling the continuous input signal is converted into a time-discrete signal and the information about the time characteristic is lost. The bandwidth of the input signal must therefore be limited or else the higher signal frequencies will cause aliasing effects due to sampling (see Fig. 3-1). According to Shannon's law of sampling, the sampling frequency f_s must be at least twice as high as the bandwidth B_{in} of the input signal. The following applies:

$$f_s \geq 2 \cdot B_{in} \quad \text{and} \quad f_s = \frac{1}{T_s} \quad (\text{Equation 3-1})$$

where f_s = sampling rate, in Hz
 B_{in} = signal bandwidth, in Hz
 T_s = sampling period, in s

For sampling lowpass-filtered signals (referred to as lowpass signals) the minimum sampling rate required is determined by the maximum signal frequency $f_{in,max}$. Equation 3-1 then becomes:

$$f_s \geq 2 \cdot f_{in,max} \quad (\text{Equation 3-2})$$

If $f_s = 2 \cdot f_{in,max}$, it may not be possible to reconstruct the signal from the sampled values due to unfavorable sampling conditions. Moreover, a lowpass filter with infinite skirt selectivity would be required for band limitation. Sampling rates that are much greater than $2 \cdot f_{in,max}$ are therefore used in practice.

A section of the signal is considered for the Fourier transform. That is, only a limited number N of samples is used for calculation. This process is called windowing. The input signal (see Fig. 3-2a) is multiplied with a specific window function before or after sampling in the time domain. In the example shown in Fig. 3-2, a rectangular window is used (Fig. 3-2b). The result of multiplication is shown in Fig. 3-2c.

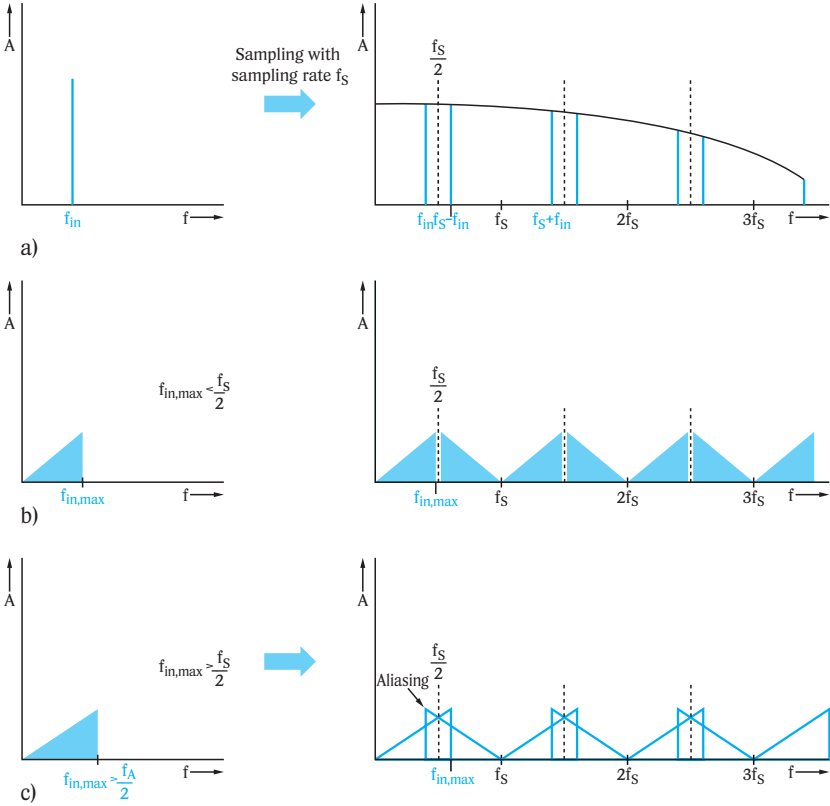

Fig. 3-1 Sampling a lowpass filter with sampling rate f_s
 a), b) $f_{in,max} < f_s/2$
 c) $f_{in,max} > f_s/2$, therefore ambiguity exists due to aliasing

The calculation of the signal spectrum from the samples of the signal in the time domain is referred to as a discrete Fourier transform (DFT). Equation 2-2 then becomes:

$$\underline{X}(k) = \sum_{n=0}^{N-1} \underline{x}(nT_s) \cdot e^{-j2\pi kn/N} \quad \text{(Equation 3-3)}$$

- where k = index of discrete frequency bins, where $k = 0, 1, 2, \dots$
- n = index of samples
- $\underline{x}(nT_s)$ = samples at the point $n \cdot T_s$, where $n = 0, 1, 2 \dots$
- N = length of DFT, i.e. total number of samples used for calculation of Fourier transform

The result of a discrete Fourier transform is again a discrete frequency spectrum (see Fig. 3-2d). The calculated spectrum is made up of individual components at the frequency bins which are expressed as:

$$f(k) = k \cdot \frac{f_s}{N} = k \cdot \frac{1}{N \cdot T_s} \quad (\text{Equation 3-4})$$

where

$f(k)$	=	discrete frequency bin, in Hz
k	=	index of discrete frequency bins, with $k = 0, 1, 2 \dots$
f_s	=	sampling frequency, in Hz
N	=	length of DFT

It can be seen that the resolution (the minimum spacing required between two spectral components of the input signal for the latter being displayed at two different frequency bins $f(k)$ and $f(k+1)$) depends on the observation time $N \cdot T_s$. The required observation time increases with the desired resolution.

The spectrum of the signal is periodicized with the period f_s through sampling (see Fig. 3-1). Therefore, a component is shown at the frequency bin $f(k=6)$ in the discrete frequency spectrum display in Fig. 3-2d. On examining the frequency range from 0 to f_s in Fig. 3-1a, it becomes evident that this is the component at $f_s - f_m$.

In the example shown in Fig. 3-2, an exact calculation of the signal spectrum was possible. There is a frequency bin in the discrete frequency spectrum that exactly corresponds to the signal frequency. The following requirements have to be fulfilled:

- the signal must be periodic (period T_0)
- the observation time $N \cdot T_s$ must be an integer multiple of the period T_0 of the signal.

These requirements are usually not fulfilled in practice so that the result of the Fourier transform deviates from the expected result. This deviation is characterized by a wider signal spectrum and an amplitude error. Both effects are described in the following.

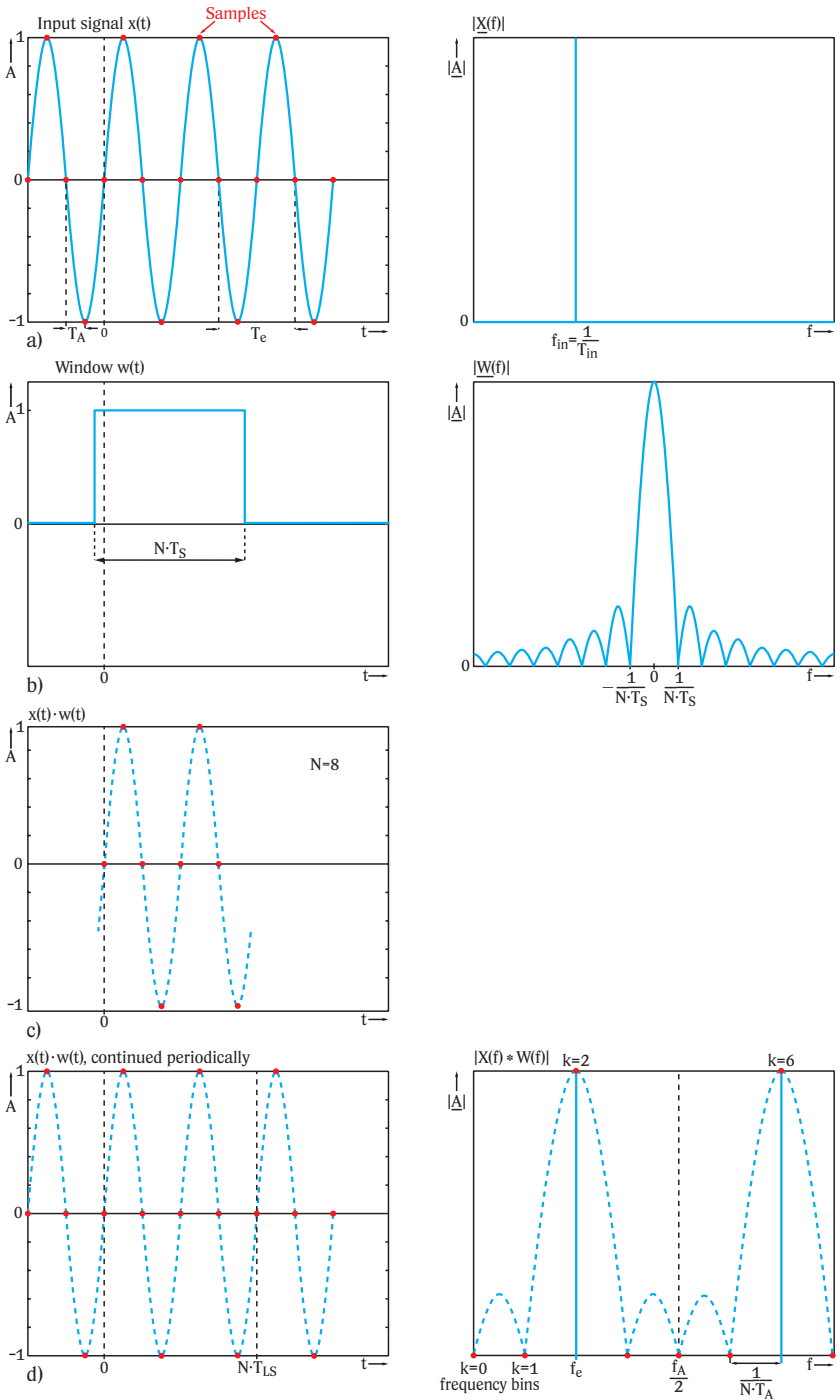

Fig. 3-2 DFT with periodic input signal. Observation time is an integer multiple of the period of the input signal

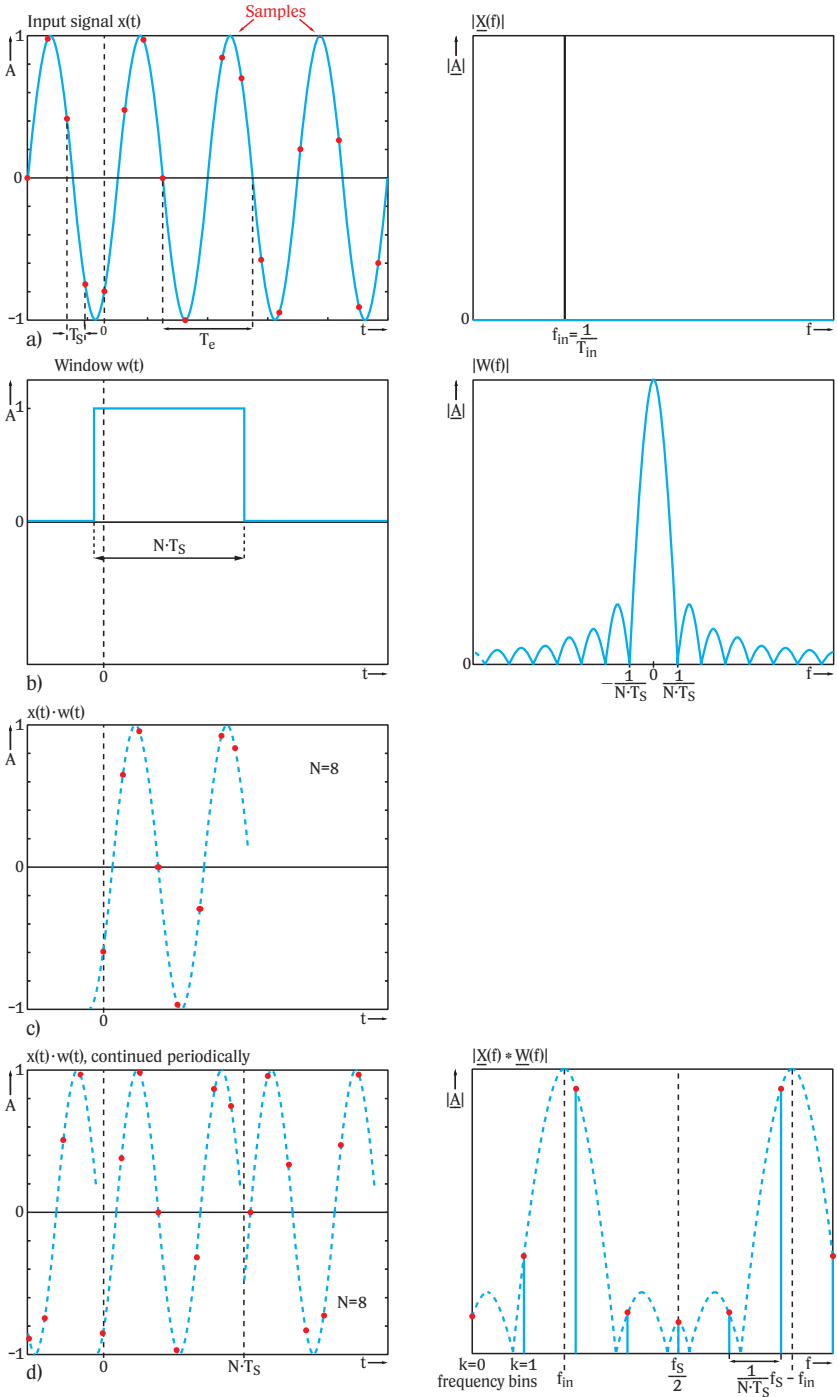

Fig. 3-3 DFT with periodic input signal. Observation time is not an integer multiple of the period of the input signal

The multiplication of input signal and window function in the time domain corresponds to a convolution in the frequency domain (see [2-1]). In the frequency domain the magnitude of the transfer function of the rectangular window used in Fig. 3-2 follows a sine function:

$$|\underline{W}(f)| = N \cdot T_s \cdot \text{si}(2\pi f \cdot N \cdot T_s/2) = N \cdot T_s \cdot \frac{\sin(2\pi f \cdot N \cdot T_s/2)}{2\pi f \cdot N \cdot T_s/2} \text{ (Equation 3-5)}$$

where $\underline{W}(f)$ = windowing function in frequency domain
 $N \cdot T_s$ = window width

In addition to the distinct secondary maxima, nulls are obtained at multiples of $1 / (N \cdot T_s)$. Due to the convolution by means of the window function the resulting signal spectrum is smeared, so it becomes distinctly wider. This is referred to as leakage effect.

If the input signal is periodic and the observation time $N \cdot T_s$ is an integer multiple of the period, there is no leakage effect of the rectangular window since, with the exception of the signal frequency, nulls always fall within the neighboring frequency bins (see Fig. 3-2d).

If these conditions are not satisfied, which is the normal case, there is no frequency bin that corresponds to the signal frequency. This case is shown in Fig. 3-3. The spectrum resulting from the DFT is distinctly wider since the actual signal frequency lies between two frequency bins and the nulls of the windowing function no longer fall within the neighboring frequency bins.

As shown in Fig. 3.3d, an amplitude error is also obtained in this case. At constant observation time the magnitude of this amplitude error depends on the signal frequency of the input signal (see Fig. 3-4). The error is at its maximum if the signal frequency is exactly between two frequency bins.

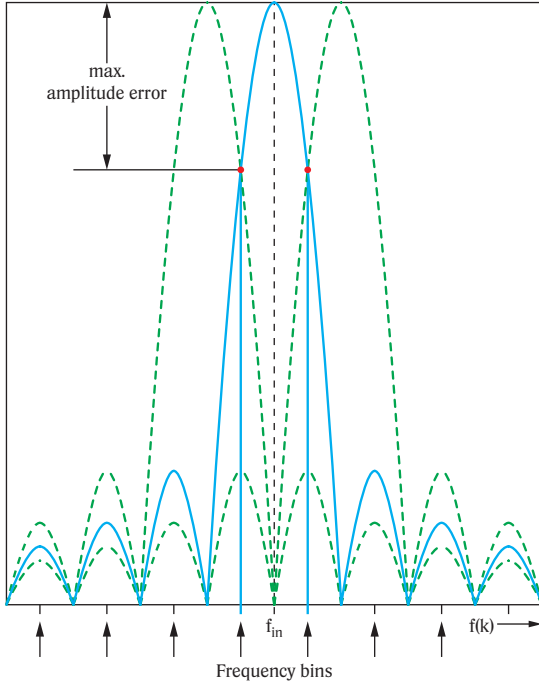

Fig. 3-4 Amplitude error caused by rectangular windowing as a function of signal frequency

By increasing the observation time it is possible to reduce the absolute widening of the spectrum through the higher resolution obtained, but the maximum possible amplitude error remains unchanged. The two effects can, however, be reduced by using optimized windowing instead of the rectangular window. Such windowing functions exhibit lower secondary maxima in the frequency domain so that the leakage effect is reduced as shown in Fig. 3-5. Further details of the windowing functions can be found in [3-1] and [3-2].

To obtain the high level accuracy required for spectrum analysis a flat-top window is usually used. The maximum level error of this windowing function is as small as 0.05 dB. A disadvantage is its relatively wide main lobe which reduces the frequency resolution.

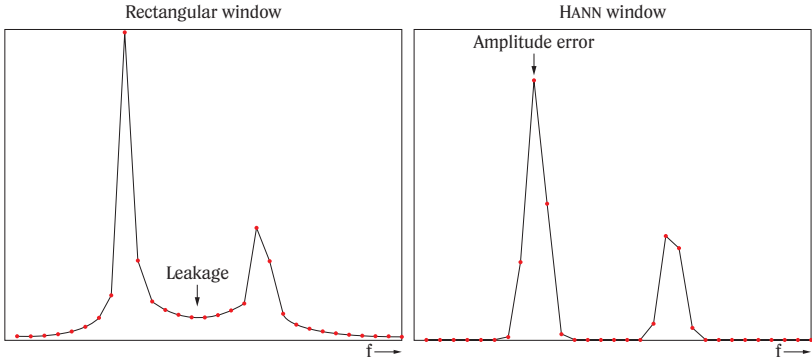

Fig. 3-5 Leakage effect when using rectangular window or Hann window (MatLab® simulation)

The number of computing operations required for the Fourier transform can be reduced by using optimized algorithms. The most widely used method is the fast Fourier transform (FFT). Spectrum analyzers operating on this principle are designated as FFT analyzers. The configuration of such an analyzer is shown in Fig. 3-6.

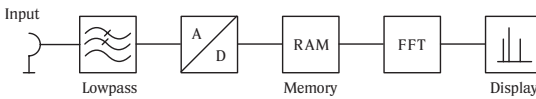

Fig. 3-6 Configuration of FFT analyzer

To adhere to the sampling theorem, the bandwidth of the input signal is limited by an analog lowpass filter (cutoff frequency $f_c = f_{in,max}$) ahead of the A/D converter. After sampling the quantized values are saved in a memory and then used for calculating the signal in the frequency domain. Finally, the frequency spectrum is displayed.

Quantization of the samples causes the quantization noise which causes a limitation of the dynamic range towards its lower end. The higher the resolution (number of bits) of the A/D converter used, the lower the quantization noise.

Due to the limited bandwidth of the available high-resolution A/D converters, a compromise between dynamic range and maximum input frequency has to be found for FFT analyzers. At present, a wide dynamic range of about 100 dB can be achieved with FFT analyzers only for low-frequency applications up to 100 kHz. Higher bandwidths inevitably lead to a smaller dynamic range.

In contrast to other analyzer concepts, phase information is not lost during the complex Fourier transform. FFT analyzers are therefore able to determine the complex spectrum according to magnitude and phase. If they feature sufficiently high computing speed, they even allow realtime analysis.

FFT analyzers are not suitable for the analysis of pulsed signals (see Fig. 3-7). The result of the FFT depends on the selected section of the time function. For correct analysis it is therefore necessary to know certain parameters of the analyzed signal, such as the triggering a specific measurement.

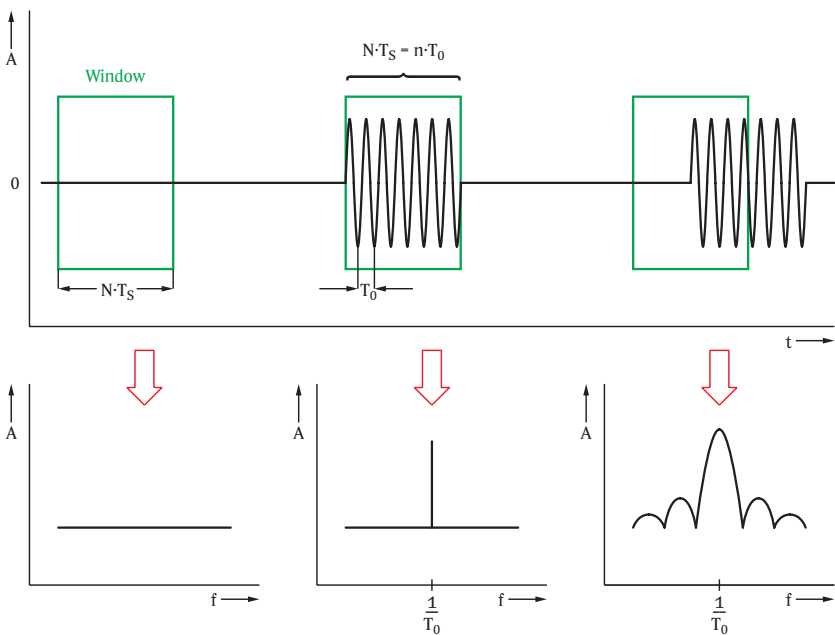

Fig. 3-7 FFT of pulsed signals.
The result depends on the time of the measurement

3.2 Analyzers operating according to the heterodyne principle

Due to the limited bandwidth of the available A/D converters, FFT analyzers are only suitable for measurements on low-frequency signals. To display the spectra of high-frequency signals in the microwave or millimeter-wave range, analyzers with frequency conversion are used. In this case the spectrum of the input signal is not calculated from the time characteristic, but determined directly by analysis in the frequency domain. For such an analysis it is necessary to break down the input spectrum into its individual components. A tunable bandpass filter as shown in Fig. 3-8 could be used for this purpose.

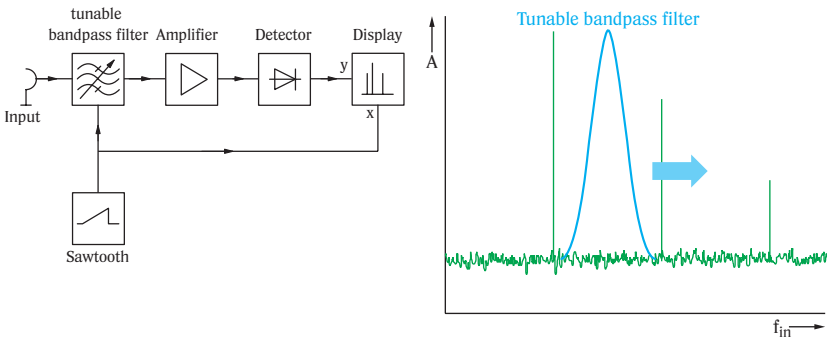

Fig. 3-8 Block diagram of spectrum analyzer with tunable bandpass filter

The filter bandwidth corresponds to the resolution bandwidth (RBW) of the analyzer. The smaller the resolution bandwidth, the higher the spectral resolution of the analyzer.

Narrowband filters tunable throughout the input frequency range of modern spectrum analyzers are, however, not technically feasible. Moreover, tunable filters have a constant relative bandwidth referred to the center frequency. The absolute bandwidth, therefore, increases with increasing center frequency so that this concept is not suitable for spectrum analysis.

Spectrum analyzers for high input frequency ranges therefore usually operate according to the principle of a heterodyne receiver. The block diagram of such a receiver is shown in Fig. 3-9.

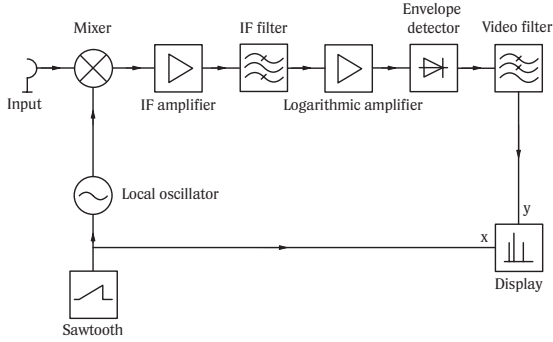

Fig. 3-9 Block diagram of spectrum analyzer operating on heterodyne principle

The heterodyne receiver converts the input signal with the aid of a mixer and a local oscillator (LO) to an intermediate frequency (IF). If the local oscillator frequency is tunable (a requirement that is technically feasible), the complete input frequency range can be converted to a constant intermediate frequency by varying the LO frequency. The resolution of the analyzer is then given by a filter at the IF with fixed center frequency.

In contrast to the concept described above, where the resolution filter as a dynamic component is swept over the spectrum of the input signal, the input signal is now swept past a fixed-tuned filter.

The converted signal is amplified before it is applied to the IF filter which determines the resolution bandwidth. This IF filter has a constant center frequency so that problems associated with tunable filters can be avoided.

To allow signals in a wide level range to be simultaneously displayed on the screen, the IF signal is compressed using of a logarithmic amplifier and the envelope determined. The resulting signal is referred to as the video signal. This signal can be averaged with the aid of an adjustable low-pass filter called a video filter. The signal is thus freed from noise and smoothed for display. The video signal is applied to the vertical deflection of a cathode-ray tube. Since it is to be displayed as a function of frequency, a sawtooth signal is used for the horizontal deflection of the electron beam as well as for tuning the local oscillator. Both the IF and the LO frequency are known. The input signal can thus be clearly assigned to the displayed spectrum.

In modern spectrum analyzers practically all processes are controlled

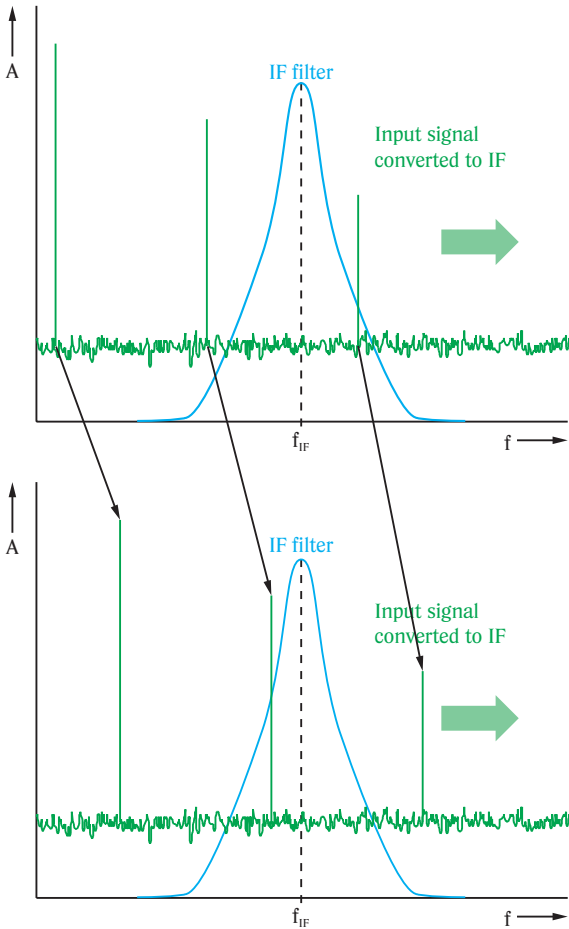

Fig. 3-10 Signal "swept past" resolution filter in heterodyne receiver

by one or several microprocessors, giving a large variety of new functions which otherwise would not be feasible. One application in this respect is the remote control of the spectrum analyzer via interfaces such as the IEEE bus.

Modern analyzers use fast digital signal processing where the input signal is sampled at a suitable point with the aid of an A/D converter and further processed by a digital signal processor. With the rapid advances made in digital signal processing, sampling modules are moved further ahead in the signal path. Previously, the video signal was sampled after the analog envelope detector and video filter, whereas with modern spec-

trum analyzers the signal is often digitized at the last low IF. The envelope of the IF signal is then determined from the samples.

Likewise, the first LO is no longer tuned with the aid of an analog sawtooth signal as with previous heterodyne receivers. Instead, the LO is locked to a reference frequency via a phase-locked loop (PLL) and tuned by varying the division factors. The benefit of the PLL technique is a considerably higher frequency accuracy than achievable with analog tuning.

An LC display can be used instead of the cathode-ray tube, which leads to more compact designs.

3.3 Main setting parameters

Spectrum analyzers usually provide the following elementary setting parameters (see Fig. 3-11):

- **Frequency display range**

The frequency range to be displayed can be set by the start and stop frequency (that is the minimum and maximum frequency to be displayed), or by the center frequency and the span centered about the center frequency. The latter setting mode is shown in Fig. 3-11. Modern spectrum analyzers feature both setting modes.

- **Level display range**

This range is set with the aid of the maximum level to be displayed (the reference level), and the span. In the example shown in Fig. 3-11, a reference level of 0 dBm and a span of 100 dB is set. As will be described later, the attenuation of an input RF attenuator also depends on this setting.

- **Frequency resolution**

For analyzers operating on the heterodyne principle, the frequency resolution is set via the bandwidth of the IF filter. The frequency resolution is therefore referred to as the resolution bandwidth (RBW).

- **Sweep time** (only for analyzers operating on the heterodyne principle)
The time required to record the whole frequency spectrum that is of interest is described as sweep time.

Some of these parameters are dependent on each other. Very small resolution bandwidths, for instance, call for a correspondingly long sweep time. The precise relationships are described in detail in chapter 4.6.

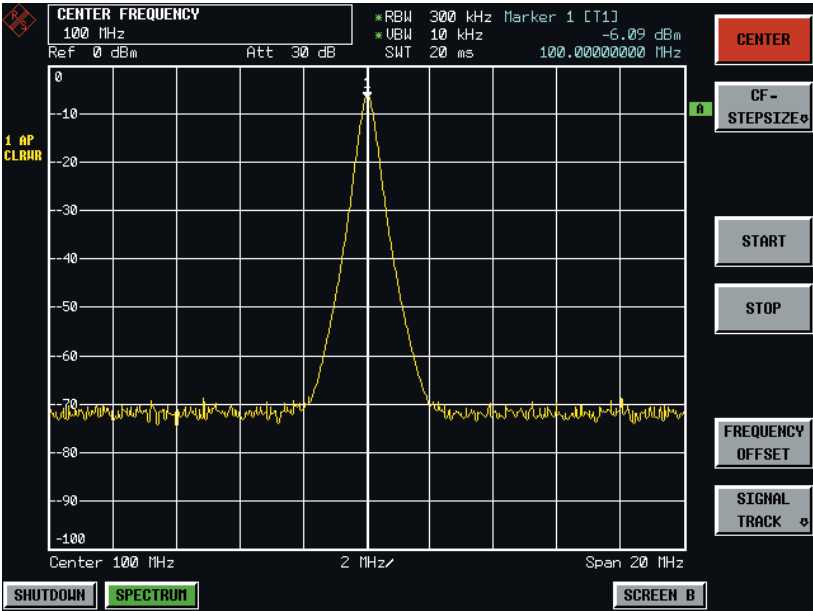

Fig. 3-11 Graphic display of recorded spectrum

4 PRACTICAL REALIZATION OF AN ANALYZER OPERATING ON THE HETERODYNE PRINCIPLE

In the following section a detailed description is given of the individual components of an analyzer operating on the heterodyne principle as well as the practical realization of a modern spectrum analyzer for a frequency range of 9 kHz to 3 GHz/7 GHz. A detailed block diagram can be found on the fold-out page at the end of the book. The individual blocks are numbered and combined in functional units.

4.1 RF input section (frontend)

Like most measuring instruments used in modern telecommunications, spectrum analyzers usually feature an RF input impedance of $50\ \Omega$. To enable measurements in $75\ \Omega$ systems such as cable television (CATV), some analyzers are alternatively provided with a $75\ \Omega$ input impedance. With the aid of impedance transformers, analyzers with $50\ \Omega$ input may also be used (see test hint: Measurements in $75\ \Omega$ system).

A quality criterion of the spectrum analyzer is the input VSWR, which is highly influenced by the frontend components, such as the attenuator, input filter and first mixer. These components form the RF input section whose functionality and realization will be examined in detail in the following:

A step attenuator (2)* is provided at the input of the spectrum analyzer for the measurement of high-level signals. Using this attenuator, the signal level at the input of the first mixer can be set.

The RF attenuation of this attenuator is normally adjustable in 10 dB steps. For measurement applications calling for a wide dynamic range, attenuators with finer step adjustment of 5 dB or 1 dB are used in some analyzers (see chapter 5.5: Dynamic range).

* The colored code numbers in parentheses refer to the block diagram at the end of the book.

Measurements in 75 Ω system

In sound and TV broadcasting, an impedance of 75 Ω is more common than the widely used 50 Ω. To carry out measurements in such systems with the aid of spectrum analyzers that usually feature an input impedance of 50 Ω, appropriate matching pads are required. Otherwise, measurement errors would occur due to mismatch between the device under test and spectrum analyzer.

The simplest way of transforming 50 Ω to 75 Ω is by means of a 25 Ω series resistor. While the latter renders for low insertion loss (approx. 1.8 dB), only the 75 Ω input is matched, however, the output that is connected to the RF input of the spectrum analyzer is mismatched (see Fig. 4-1a). Since the input impedance of the spectrum analyzer deviates from the ideal 50 Ω value, measurement errors due to multiple reflection may occur especially with mismatched DUTs.

Therefore it is recommendable to use matching pads that are matched at both ends (e.g. Π or L pads). The insertion loss through the attenuator may be higher in this case.

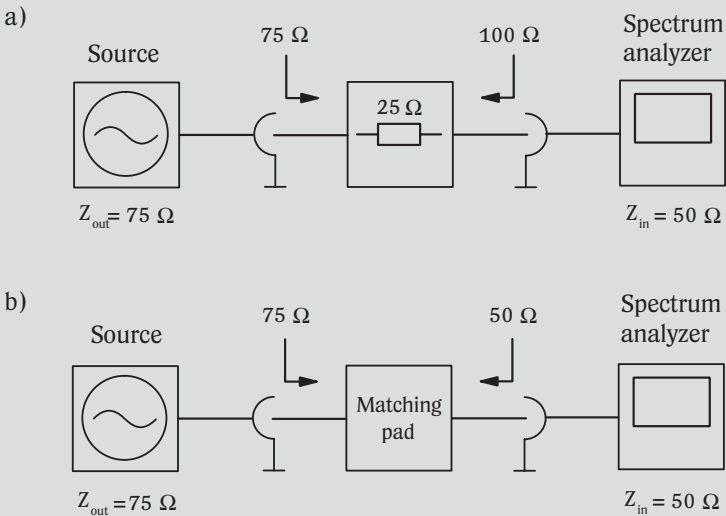

Fig. 4-1 Input matching to 75 Ω using external matching pads

The heterodyne receiver converts the input signal with the aid of a mixer (4) and a local oscillator (5) to an intermediate frequency (IF). This type of frequency conversion can generally be expressed as:

$$|m \cdot f_{LO} \pm n \cdot f_{in}| = f_{IF} \tag{Equation 4-1}$$

where

m, n	=	1, 2, ...
f_{LO}	=	frequency of local oscillator
f_{in}	=	frequency of input signal to be converted
f_{IF}	=	intermediate frequency

If the fundamentals of the input and LO signal are considered ($m, n = 1$), Equation 4-1 is simplified to:

$$|f_{LO} \pm f_{in}| = f_{IF} \tag{Equation 4-2}$$

or solved for f_{in}

$$f_{in} = |f_{LO} \pm f_{IF}| \tag{Equation 4-3}$$

With a continuously tunable local oscillator a wide input frequency range can be realized at a constant IF. Equation 4-3 indicates that for certain LO and intermediate frequencies, there are always two receiver frequencies for which the criterion according to Equation 4-2 is fulfilled (see Fig. 4-2). This means that in addition to the desired receiver frequency, there are also image frequencies. To ensure unambiguity of this concept, input signals at such unwanted image frequencies have to be rejected with the aid of suitable filters ahead of the RF input of the mixer.

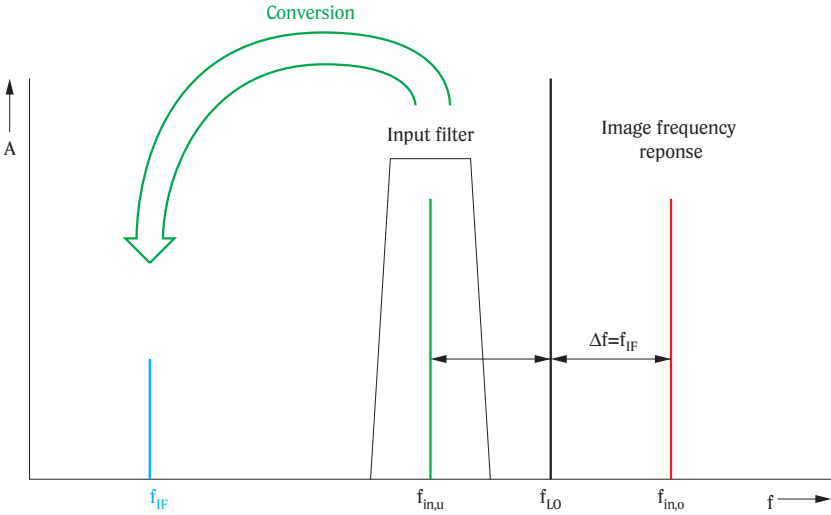

Fig. 4-2 Ambiguity of heterodyne principle

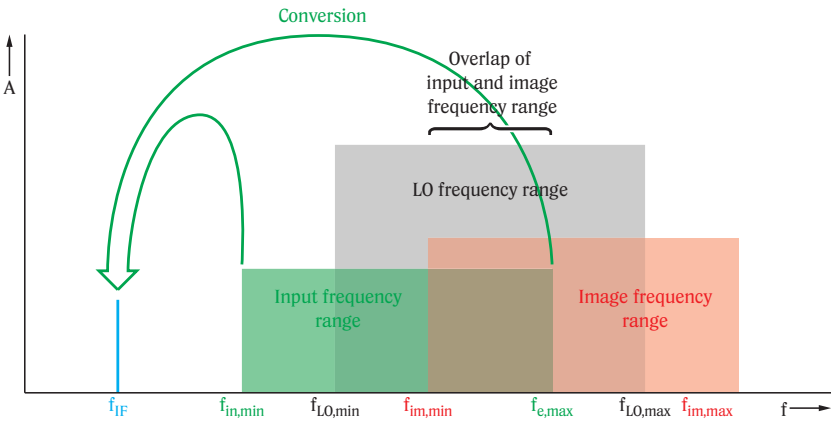

Fig. 4-3 Input and image frequency ranges (overlapping)

Fig. 4-3 illustrates the input and image frequency ranges for a tunable receiver with low first IF. If the input frequency range is greater than $2 \cdot f_{ZF}$, the two ranges are overlapping, so an input filter must be implemented as a tunable bandpass for image frequency rejection without affecting the wanted input signal.

To cover the frequency range from 9 kHz to 3 GHz, which is typical of modern spectrum analyzers, this filter concept would be extremely complex because of the wide tuning range (several decades). Much less complex is the principle of a high first IF (see Fig. 4-4).

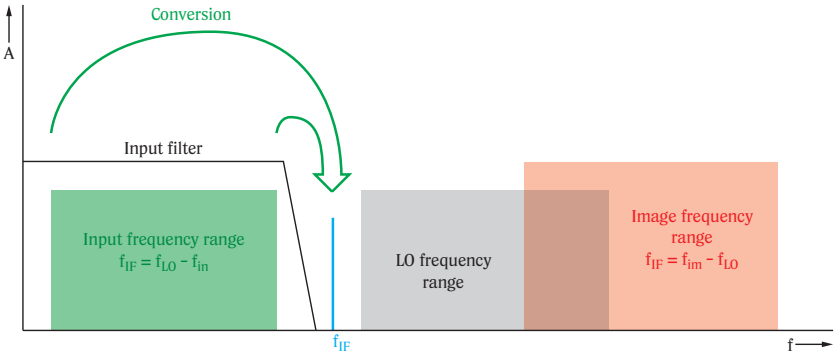

Fig. 4-4 Principle of high intermediate frequency

In this configuration, image frequency range lies above the input frequency range. Since the two frequency ranges do not overlap, the image frequency can be rejected by a fixed-tuned lowpass filter. The following relationships hold for the conversion of the input signal:

$$f_{IF} = f_{LO} - f_{in} \tag{Equation 4-4}$$

and for the image frequency response:

$$f_{IF} = f_{im} - f_{LO} \tag{Equation 4-5}$$

Frontend for frequencies up to 3 GHz

For analyzers implemented to cover the frequency range from 9 kHz to 3 GHz, the input attenuator (2) is followed by a lowpass filter (3) for rejection of the image frequencies. Due to the limited isolation between RF and IF port as well as between LO and RF port of the first mixer, this lowpass filter also serves for minimizing the IF feedthrough and LO reradiation at the RF input.

In our example the first IF is 3476.4 MHz. For converting the input frequency range from 9 kHz to 3 GHz to an upper frequency of 3476.4 MHz, the LO signal (5) must be tunable in the frequency range from 3476.40 MHz to 6476.4 MHz. According to Equation 4-5, an image frequency range from 6952.809 MHz to 9952.8 MHz is then obtained.

Measurement on signals with DC component

Many spectrum analyzers, in particular those featuring a very low input frequency at their lower end (such as 20 Hz), are DC-coupled, so there are no coupling capacitors in the signal path between RF input and first mixer.

A DC voltage may not be applied to the input of a mixer because it usually damages the mixer diodes. For measurements of signals with DC components, an external coupling capacitor (DC block) is used with DC-coupled spectrum analyzers. It should be noted that the input signal is attenuated by the insertion loss of this DC block. This insertion loss has to be taken into account in absolute level measurements.

Some spectrum analyzers have an integrated coupling capacitor to prevent damage to the first mixer. The lower end of the frequency range is thus raised. AC-coupled analyzers therefore have a higher input frequency at the lower end, such as 9 kHz.

Due to the wide tuning range and low phase noise far from the carrier (see chapter 5.3: Phase noise) a YIG oscillator is often used as local oscillator. This technology uses a magnetic field for tuning the frequency of a resonator.

Some spectrum analyzers use voltage-controlled oscillators (VCO) as local oscillators. Although such oscillators feature a smaller tuning range than the YIG oscillators, they can be tuned much faster than YIG oscillators.

To increase the frequency accuracy of the recorded spectrum, the LO signal is synthesized. That is, the local oscillator is locked to a reference signal (26) via a phase-locked loop (6). In contrast to analog spectrum analyzers, the LO frequency is not tuned continuously, but in many small steps. The

step size depends on the resolution bandwidth. Small resolution bandwidths call for small tuning steps. Otherwise, the input signal may not be fully recorded or level errors could occur. To illustrate this effect, a filter tuned in steps throughout the input frequency range is shown in Fig. 4-5. To avoid such errors, a step size that is much lower than the resolution bandwidth (such as $0.1 \cdot \text{RBW}$) is selected in practice.

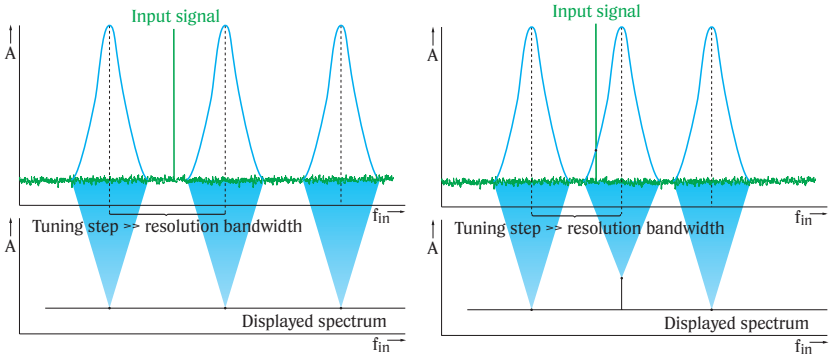

Fig. 4-5 Effects of too large tuning steps
a) input signal is completely lost
b) level error in display of input signal

The reference signal is usually generated by a temperature-controlled crystal oscillator (TCXO). To increase the frequency accuracy and long-term stability (see also chapter 5.9 Frequency accuracy), an oven-controlled crystal oscillator (OCXO) is optionally available for most spectrum analyzers. For synchronization with other measuring instruments, the reference signal (usually 10 MHz) is made available at an output connector (28). The spectrum analyzer may also be synchronized to an externally applied reference signal (27). If only one connector is available for coupling a reference signal in or out, the function of such connector usually depends on a setting internal to the spectrum analyzer.

As shown in Fig. 3-9, the first conversion is followed by IF signal processing and detection of the IF signal. With such a high IF, narrowband IF filters can hardly be implemented, which means that the IF signal in the concept described here has to be converted to a lower IF (such as 20.4 MHz in our example).

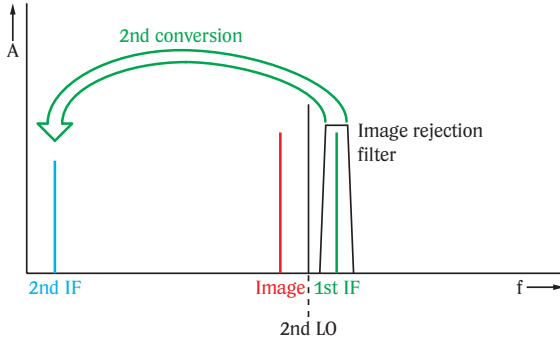

Fig. 4-6 Conversion of high 1st IF to low 2nd IF

With direct conversion to 20.4 MHz, the image frequency would only be offset $2 \cdot 20.4 \text{ MHz} = 40.8 \text{ MHz}$ from the signal to be converted at 3476.4 MHz (Fig. 4-6). Rejection of this image frequency is important since the limited isolation between the RF and IF port of the mixers signals may be passed to the first IF without conversion. This effect is referred to as IF feedthrough (see chapter 5.6: Immunity to interference). If the frequency of the input signal corresponds to the image frequency of the second conversion, this effect is shown in the image frequency response of the second IF. Under certain conditions, input signals may also be converted to the image frequency of the second conversion. Since the conversion loss of mixers is usually much smaller than the isolation between RF and IF port of the mixers, this kind of image frequency response is far more critical.

Due to the high signal frequency, an extremely complex filter with high skirt selectivity would be required for image rejection at a low IF of 20.4 MHz. It is therefore advisable to convert the input signal from the first IF to a medium IF such as 404.4 MHz as in our example. A fixed LO signal (10) of 3072 MHz is required for this purpose since the image frequency for this conversion is at 2667.6 MHz. Image rejection is then simple to realize with the aid of a suitable bandpass filter (8). The bandwidth of this bandpass filter must be sufficiently large so that the signal will not be impaired even for maximum resolution bandwidths. To reduce the total noise figure of the analyzer, the input signal is amplified (7) prior to the second conversion.

The input signal converted to the second IF is amplified again, filtered by an image rejection bandpass filter for the third conversion and converted to the low IF of 20.4 MHz with the aid of a mixer. The signal thus obtained can be subjected to IF signal processing.

Frontend for frequencies above 3 GHz

The principle of a high first IF calls for a high LO frequency range ($f_{LO,max} = f_{in,max} + f_{1stIF}$). In addition to a broadband RF input, the first mixer must also feature an extremely broadband LO input and IF output - requirements that are increasingly difficult to satisfy if the upper input frequency limit is raised. Therefore this concept is only suitable for input frequency ranges up to 7 GHz.

To cover the microwave range, other concepts have to be implemented by taking the following criteria into consideration:

- The frequency range from 3 GHz to 40 GHz extends over more than a decade, whereas 9 kHz to 3 GHz corresponds to approx. 5.5 decades.
- In the microwave range, filters tunable in a wide range and with narrow relative bandwidth can be implemented with the aid of YIG technology [4-1]. Tuning ranges from 3 GHz to 50 GHz are fully realizable.

Direct conversion of the input signal to a low IF calls for a tracking bandpass filter for image rejection. In contrast to the frequency range up to 3 GHz, such preselection can be implemented for the range above 3 GHz due to the previously mentioned criteria. Accordingly, the local oscillator need only be tunable in a frequency range that corresponds to the input frequency range.

In our example the frequency range of the spectrum analyzer is thus enhanced from 3 GHz to 7 GHz. After the attenuator, the input signal is split by a diplexer (19) into the frequency ranges 9 kHz to 3 GHz and 3 GHz to 7 GHz and applied to corresponding RF frontends.

In the high-frequency input section, the signal passes a tracking YIG filter (20) to the mixer. The center frequency of the bandpass filter corresponds to the input signal frequency to be converted to the IF. Direct conversion to a low IF (20.4 MHz, in our example) is difficult with this concept due to the bandwidth of the YIG filter. It is therefore best to convert the signal first to a medium IF (404.4 MHz) as was performed with the low-frequency input section.

In our example, a LO frequency range from 2595.6 MHz to 6595.6 MHz would be required for converting the input signal as upper sideband, (that is for $f_{IF} = f_{in} - f_{LO}$). For the conversion as lower sideband ($f_{IF} = f_{LO} - f_{in}$), the local oscillator would have to be tunable from 3404.4 MHz to 7404.4 MHz.

If one combines the two conversions by switching between the upper and lower sideband at the center of the input frequency band, this concept can be implemented even with a limited LO frequency range of 3404.4 MHz to 6595.6 MHz (see Fig. 4-7).

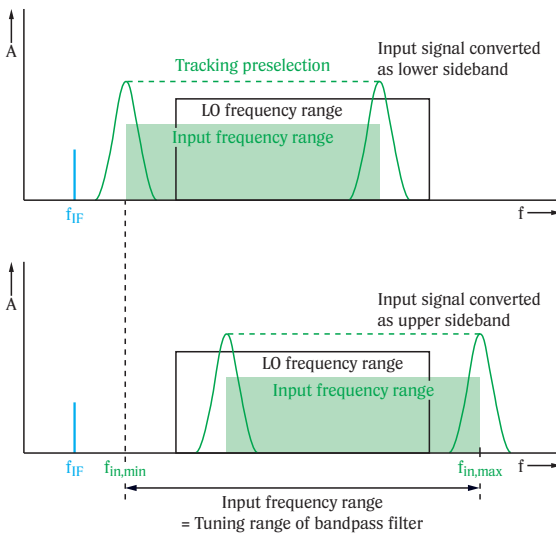

Fig. 4-7 Conversion to a low IF; image rejection by tracking preselection

The signal converted to an IF of 404.4 MHz is amplified (23) and coupled into the IF signal path of the low-frequency input section through a switch (13).

Upper and lower frequency limits of this implementation are determined by the technological constraints of the YIG filter. A maximum frequency of about 50 GHz is feasible.

In our example, the upper limit of 7 GHz is determined by the tuning range of the local oscillator. There are again various configurations for converting input signals above 7 GHz with the given LO frequency range:

- **Fundamental mixing**

The input signal is converted by means of the fundamental of the LO signal. For covering a higher frequency range with the given LO frequency range it is necessary to double, for instance, the LO signal frequency by means of a multiplier before the mixer.

- **Harmonic mixing**

The input signal is converted by a means of a harmonic of the LO signal produced in the mixer due to the mixer's nonlinearities.

Fundamental mixing is preferred to obtain minimal conversion loss, thereby maintaining a low noise figure for the spectrum analyzer. The superior characteristics attained in this way, however, require complex processing of the LO signal. In addition to multipliers (22), filters are required for rejecting subharmonics after multiplying. The amplifiers required for a sufficiently high LO level must be highly broadband since they must be designed for a frequency range that roughly corresponds to the input frequency range of the high-frequency input section.

Conversion by means of harmonic mixing is easier to implement but implies a higher conversion loss. A LO signal in a comparatively low frequency range is required which has to be applied at a high level to the mixer. Due to the nonlinearities of the mixer and the high LO level, harmonics of higher order with sufficient level are used for the conversion. Depending on the order m of the LO harmonic, the conversion loss of the mixer compared to that in fundamental mixing mode is increased by:

$$\Delta a_M = 20 \cdot \log m \quad \text{(Equation 4-6)}$$

where Δa_M = increase of conversion loss compared to that in fundamental mixing mode
 m = order of LO harmonic used for conversion

The two concepts are employed in practice depending on the price class of the analyzer. A combination of the two methods is possible. For example, a conversion using the harmonic of the LO signal doubled by a multiplier would strike a compromise between complexity and sensitivity at an acceptable expense.

External mixers

For measurements in the millimeter-wave range (above 40 GHz), the frequency range of the spectrum analyzer can be enhanced by using external harmonic mixers. These mixers operate on the principle of harmonic mixing, so a LO signal in a frequency range that is low compared to the input signal frequency range is required.

The input signal is converted to a low IF by means of a LO harmonic and an IF input inserted at a suitable point into the IF signal path of the low-frequency input section of the analyzer.

In the millimeter-wave range, waveguides are normally used for conducted signal transmission. Therefore, external mixers available for enhancing the frequency range of spectrum analyzers are usually waveguides. These mixers do not normally have a preselection filter and therefore do not provide for image rejection. Unwanted mixture products have to be identified with the aid of suitable algorithms. Further details about frequency range extension with the aid of external harmonic mixers can be found in [4-2].

4.2 IF signal processing

IF signal processing is performed at the last intermediate frequency, (20.4 MHz in our example).

Here the signal is amplified again and the resolution bandwidth defined by the IF filter.

The gain at this last IF can be adjusted in defined steps (0.1 dB steps in our example), so the maximum signal level can be kept constant in the subsequent signal processing regardless of the attenuator setting and mixer level. With high attenuator settings, the IF gain has to be increased so that the dynamic range of the subsequent envelope detector and A/D converter will be fully utilized (see chapter 4.6: Parameter dependencies).

The IF filter is used to define that section of the IF-converted input signal that is to be displayed at a certain point on the frequency axis. Due to the high skirt selectivity and resulting selectivity characteristics, a rectangular filter would be desirable. The transient response, however, of such rectangular filters is unsuitable for spectrum analysis. Since such a filter has a long transient time, the input signal spectrum could be converted to the IF only by varying the LO frequency very slowly to avoid level errors from occurring. Short measurement times can be achieved through the use of Gaussian filters optimized for transients. The transfer function of such a filter is shown in Fig. 4-8.

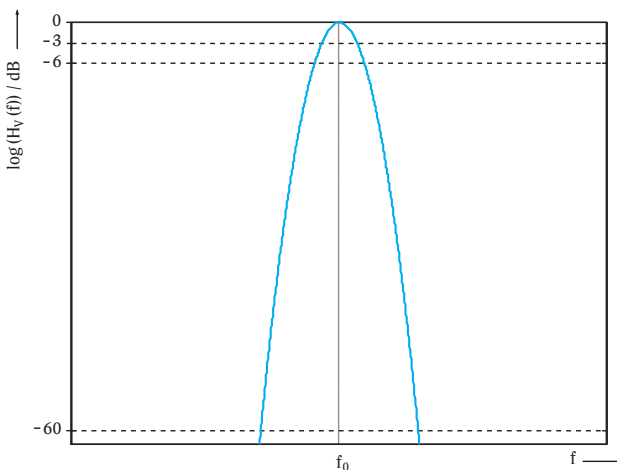

Fig. 4-8 Voltage transfer function of Gaussian filter in logarithmic level scale

In contrast to rectangular filters featuring an abrupt transition from pass-band to stopband, the bandwidth of Gaussian filters must be specified for filters with limited skirt selectivity. In spectrum analysis it is common practice to specify the 3 dB bandwidth (the frequency spacing between two points of the transfer function at which the insertion loss of the filter has increased by 3 dB relative to the center frequency).

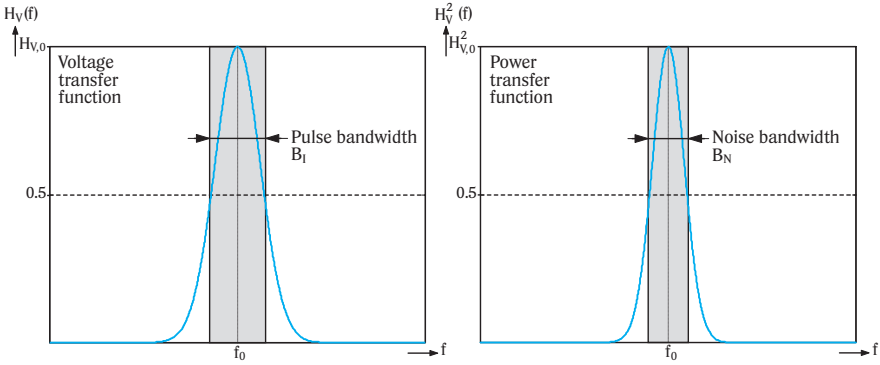

Fig. 4-9 Voltage and power transfer function of Gaussian filter in linear level scale

For many measurements on noise or noise-like signals, such as digitally modulated signals, the measured levels have to be referred to the measurement bandwidth. To this end, the equivalent noise bandwidth B_N of the IF filter must be known. This can be calculated from the transfer function as follows:

$$B_R = \frac{1}{H_{V,0}^2} \cdot \int_0^{+\infty} H_V^2(f) \cdot df \tag{Equation 4-7}$$

- where B_N = noise bandwidth, in Hz
- $H_V(f)$ = voltage transfer function
- $H_{V,0}$ = value of voltage transfer function at center of band (at f_0)

This can best be illustrated by looking at the power transfer function on the linear level scale (Fig. 4-9). The noise bandwidth corresponds to the width of a rectangle with the same area as the area of the transfer function $H_V^2(f)$. The effects of the noise bandwidth of the IF filter are dealt with in detail in chapter 5.1: Inherent noise.

For measurements on correlated signals, as can typically be found in the field of radar, the pulse bandwidth is also of interest. In contrast to the noise bandwidth, the pulse bandwidth is calculated by integration of the voltage transfer function. The following applies:

$$B_I = \frac{1}{H_{V,0}} \cdot \int_0^{+\infty} H_V(f) \cdot df \tag{Equation 4-8}$$

- where B_I = pulse bandwidth, in Hz
- $H_V(f)$ = voltage transfer function
- $H_{V,0}$ = value of voltage transfer function at center of band (at f_0)

The pulse bandwidth of Gaussian or Gaussian-like filters corresponds approximately to the 6 dB bandwidth. In the field of interference measurements, where spectral measurements on pulses are frequently carried out, 6 dB bandwidths are exclusively specified. Further details of measurements on pulsed signals can be found in chapter 6.2.

Chapter 6 concentrates on pulse and phase noise measurements. For these and other measurement applications the exact relationships between 3 dB, 6 dB, noise and pulse bandwidth are of particular interest. Table 4-1 gives conversion factors for various filters that are described in detail further below.

Initial value is	4 filter circuits	5 filter circuits	Gaussian filter
3 dB bandwidth	(analog)	(analog)	(digital)
6 dB bandwidth (B_{6dB})	$1.480 \cdot B_{3dB}$	$1.464 \cdot B_{3dB}$	$1.415 \cdot B_{3dB}$
Noise bandwidth (B_N)	$1.129 \cdot B_{3dB}$	$1.114 \cdot B_{3dB}$	$1.065 \cdot B_{3dB}$
Pulse bandwidth (B_I)	$1.806 \cdot B_{3dB}$	$1.727 \cdot B_{3dB}$	$1.506 \cdot B_{3dB}$
3 dB bandwidth (B_{3dB})	$0.676 \cdot B_{6dB}$	$0.683 \cdot B_{6dB}$	$0.707 \cdot B_{6dB}$
Noise bandwidth (B_N)	$0.763 \cdot B_{6dB}$	$0.761 \cdot B_{6dB}$	$0.753 \cdot B_{6dB}$
Pulse bandwidth (B_I)	$1.220 \cdot B_{6dB}$	$1.179 \cdot B_{6dB}$	$1.065 \cdot B_{6dB}$

Fig. 4-1 Relationship between 3 dB/6 dB bandwidths and noise and pulse bandwidths

If one uses an analyzer operating on the heterodyne principle to record a purely sinusoidal signal, one would expect a single spectral line according to the Fourier theorem even when a small frequency span about the signal frequency is taken. In fact, the display shown in Fig. 4-10 is obtained.

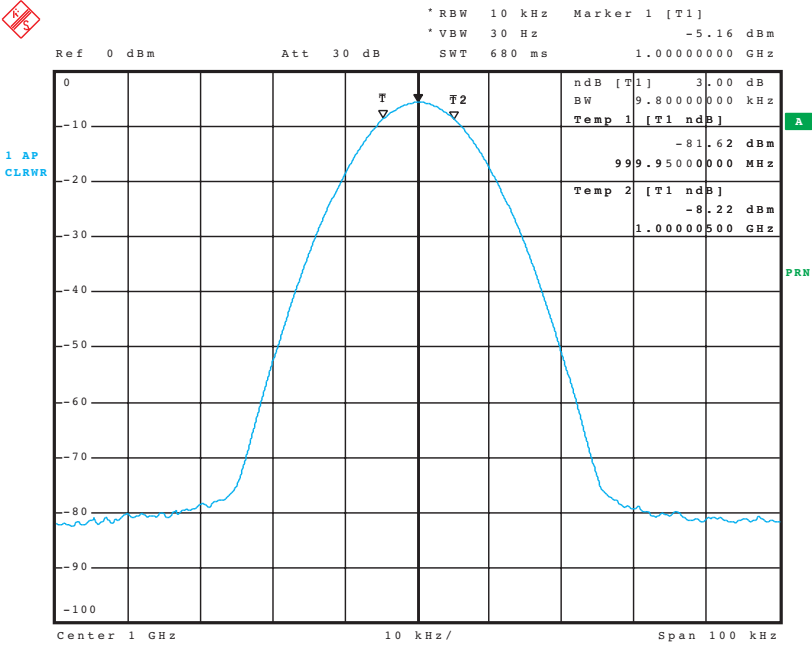

Fig. 4-10 IF filter imaged by a sinusoidal input signal

The display shows the image of the IF filter. During the sweep, the input signal converted to the IF is “swept past” the IF filter and multiplied with the transfer function of the filter.

A schematic diagram of this process is shown in Fig. 4-11. For reasons of simplification the filter is “swept past” a fixed-tuned signal, both kinds of representations being equivalent.

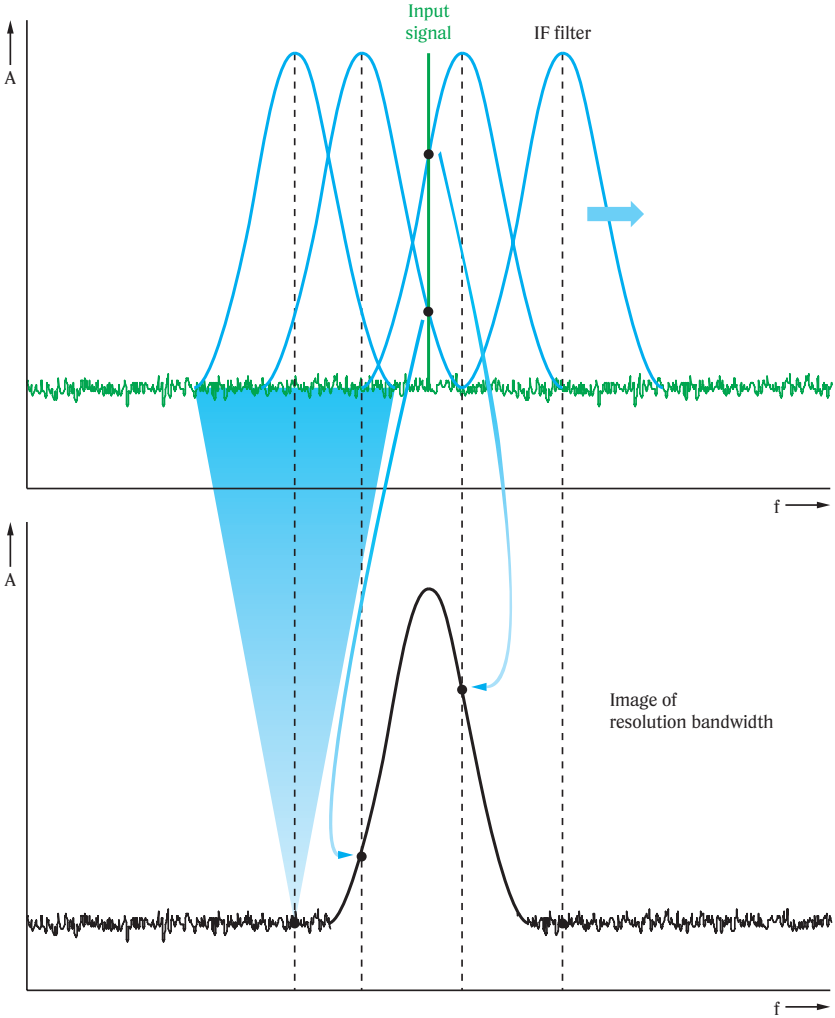

Fig. 4-11 IF filter imaged by an input signal “swept past” the filter (schematic representation of imaging process)

As pointed out before, the spectral resolution of the analyzer is mainly determined by the resolution bandwidth, that is, the bandwidth of the IF filter. The IF bandwidth (3 dB bandwidth) corresponds to the minimum frequency offset required between two signals of equal level to make the signals distinguishable by a dip of about 3 dB in the display when using a sample or peak detector (see chapter 4.4.). This case is shown in Fig. 4-12a. The red trace was recorded with a resolution bandwidth of 30 kHz. By re-

ducing the resolution bandwidth, the two signals are clearly distinguishable (Fig. 4-12a, blue trace).

If two neighboring signals have distinctly different levels, the weaker signal will not be shown in the displayed spectrum at a too high resolution bandwidth setting (see Fig. 4-12b, red trace). By reducing the resolution bandwidth, the weak signal can be displayed.

In such cases, the skirt selectivity of the IF filter is also important and is referred to as the selectivity of a filter. The skirt selectivity is specified in form of the shape factor which is calculated as follows:

$$SF_{60/3} = \frac{B_{60dB}}{B_{3dB}} \quad \text{(Equation 4-9)}$$

where B_{3dB} = 3 dB bandwidth
 B_{60dB} = 60 dB bandwidth

For 6 dB bandwidths, as is customary in EMC measurements, the shape factor is derived from the ratio of the 60 dB bandwidth to the 6 dB bandwidth.

The effects of the skirt selectivity can clearly be seen in Fig. 4-13. One Kilo-hertz IF filters with different shape factors were used for the two traces. In the blue trace (SF = 4.6), the weaker signal can still be recognized by the dip, but a separation of the two signals is not possible in the red trace (SF = 9.5) where the weaker signal does not appear at all.

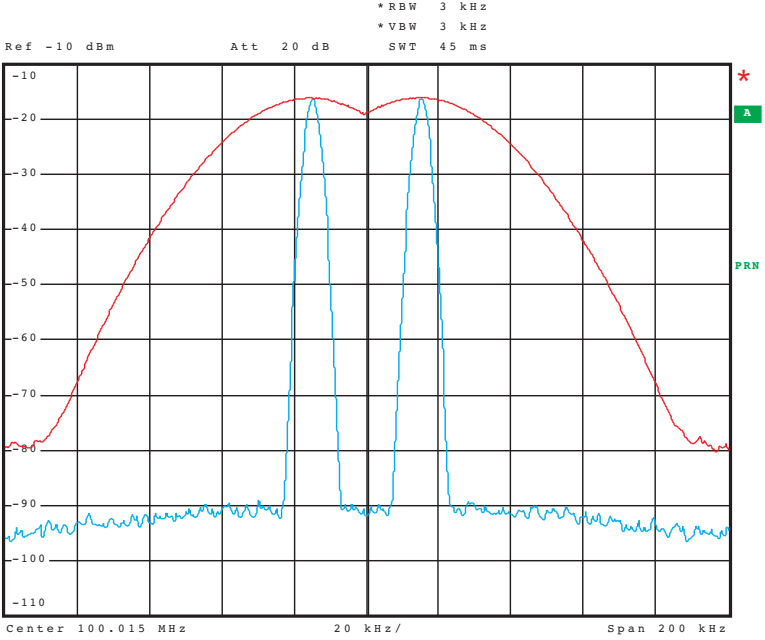

a)

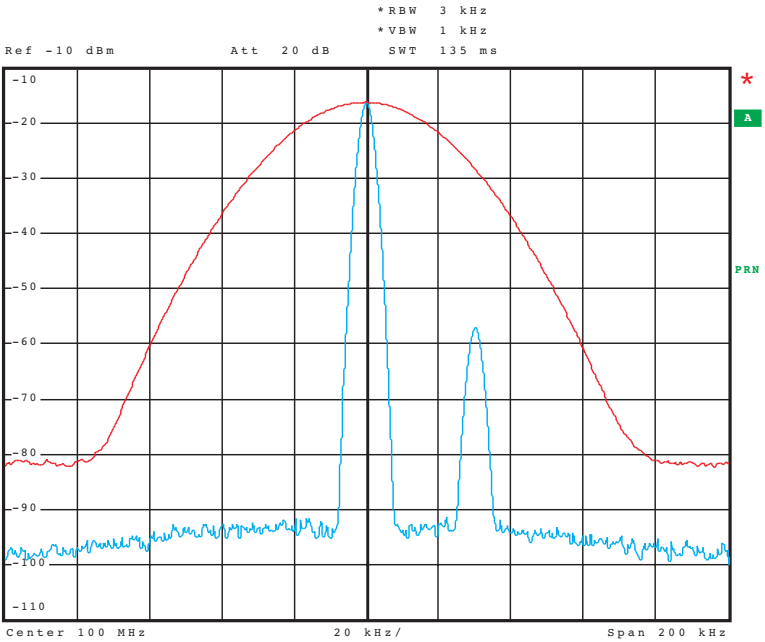

b)

Fig. 4-12 Spectrum of input signal consisting of two sinusoidal carriers with same and with different level, recorded with different resolution bandwidths (blue traces RBW = 3 kHz, red traces RBW = 30 kHz)

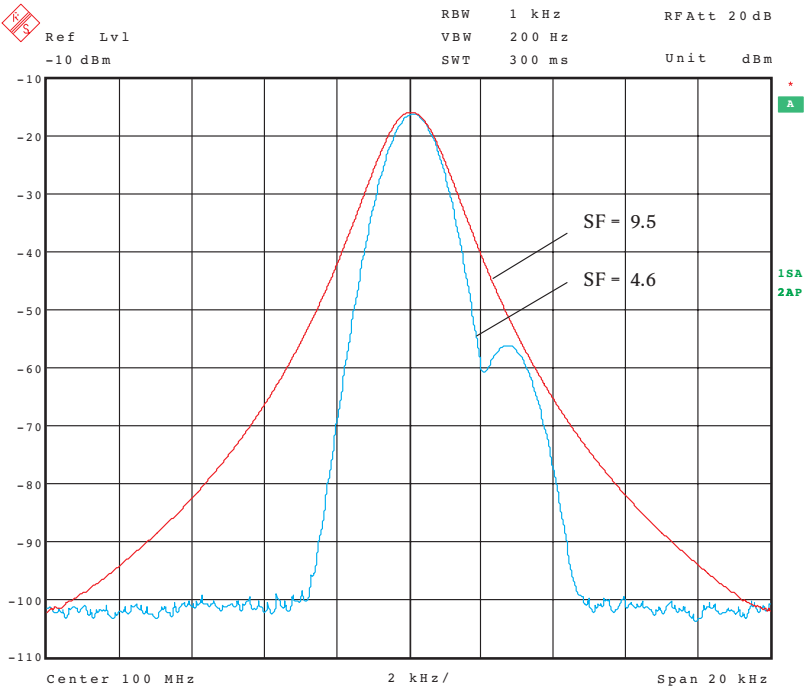

Fig. 4-13 Two neighboring sinusoidal signals with different levels recorded with a resolution bandwidth of 1 kHz and a shape factor of 9.5 and 4.6

If the weaker signal is to be distinguished by a filter with a lower skirt selectivity, the resolution bandwidth has to be reduced. Due to the longer transient time of narrowband IF filters, the minimum sweep time must be increased. For certain measurement applications, shorter sweep times are therefore feasible with filters of high skirt selectivity.

As mentioned earlier, the highest resolution is attained with narrowband IF filters. These filters, however, always have a longer transient time than broadband filters, so contemporary spectrum analyzers provide a large number of resolution bandwidths to allow resolution and measurement speed to be adapted to specific applications. The setting range is usually large (from 10 Hz to 10 MHz). The individual filters are implemented in different ways. There are three different types of filters:

- analog filters
- digital filters
- FFT

Analog IF filters

Analog filters are used to realize very large resolution bandwidths. In the spectrum analyzer described in our example, these are bandwidths from 100 kHz to 10 MHz. Ideal Gaussian filters cannot be implemented using analog filters. A very good approximation, however, is possible at least within the 20 dB bandwidth so that the transient response is almost identical to that of a Gaussian filter. The selectivity characteristics depend on the number of filter circuits. Spectrum analyzers typically have four filter circuits, but models with five filter circuits can be found, too. Shape factors of about 14 and 10 can thus be attained, whereas an ideal Gaussian filter exhibits a shape factor of 4.6.

The spectrum analyzer described in our example uses IF filters that are made up of four individual circuits. Filtering is distributed so that two filter circuits each (29 and 31) are arranged before and after the IF amplifier (30). This configuration offers the following benefits:

- The filter circuits ahead of the IF amplifier provide for rejection of mixture products outside the passband of the IF filter. Intermodulation products that may be caused by such signals in the last IF amplifier without prefiltering can thus be avoided (see chapter 5.2: Nonlinearities).
- The filter circuits after the IF amplifier are used to reduce the noise bandwidth. If they were arranged ahead of the IF amplifier, the total noise power in the subsequent envelope detection would be distinctly higher due to the broadband noise of the IF amplifier.

Digital IF filters

Narrow bandwidths can best be implemented with the aid of digital signal processing. In contrast to analog filters, ideal Gaussian filters can be realized. Much better selectivity ($SF = 4.6$) can be achieved using digital filters instead of analog filters at an acceptable circuit cost. Analog filters consisting of five individual circuits, for instance, have a shape factor of about 10, whereas a digitally implemented ideal Gaussian filter exhibits a shape factor of 4.6. Moreover, digital filters feature temperature stability, are free of aging effects and do not require adjustment. Therefore they feature a higher accuracy regarding bandwidth.

The transient response of digital filters is defined and known. Using suitable correction factors, digital filters allow shorter sweep times than analog filters of the same bandwidth (see chapter 4.6: Parameter dependencies).

In contrast to that shown in the block diagram, the IF signal after the IF amplifier must first be sampled by an A/D converter. To comply with the sampling theorem, the bandwidth of the IF signal must be limited by analog prefilters prior to sampling. This band limiting takes place before the IF amplifier so that intermodulation products can be avoided, as was the case for analog filters. The bandwidth of the prefilter is variable, so depending on the set digital resolution bandwidth, a very small bandwidth can be selected. The digital IF filter provides for limiting the noise bandwidth prior to envelope detection.

The digital IF filter can be implemented by configurations as described in [3-1] or [3-2]. In our example, the resolution bandwidths from 10 Hz to 30 kHz of the spectrum analyzer are realized by digital filters.

FFT

Very narrow IF bandwidths lead to long transient times which considerably reduce the permissible sweep speed. With very high resolution it is therefore advisable to calculate the spectrum from the time characteristic - similar to the FFT analyzer described in chapter 3.1. Since very high frequency signals (up to several GHz) cannot directly be sampled by an A/D converter, the frequency range of interest is converted to the IF as a block, using a fixed-tuned LO signal, and the bandpass signal is sampled in the time domain (see Fig. 4-14). To ensure unambiguity, an analog prefilter is required in this case.

For an IF signal with the center frequency f_{IF} and a bandwidth B , one would expect a minimum sampling rate of $2 \cdot (f_{IF} + 0,5 \cdot B)$ according to sampling requirements (Equation 3-1). If the relative bandwidth, however, is small ($B/f_{IF} \ll 1$), then undersampling is permissible to a certain extent. That is, the sampling frequency may be lower than that resulting from the sampling theorem for baseband signals. To ensure unambiguity, adherence to the sampling theorem for bandpass signals must be maintained. The permissible sampling frequencies are determined by:

$$\frac{2 \cdot f_{IF} + B}{k + 1} \leq f_s \leq \frac{2 \cdot f_{IF} - B}{k} \quad (\text{Equation 4-10})$$

where f_s = sampling frequency, in Hz
 f_{IF} = intermediate frequency, in Hz
 B = bandwidth of IF signal, in Hz
 k = 1, 2, ...

The spectrum can be determined from the sampled values with the aid of the Fourier transform.

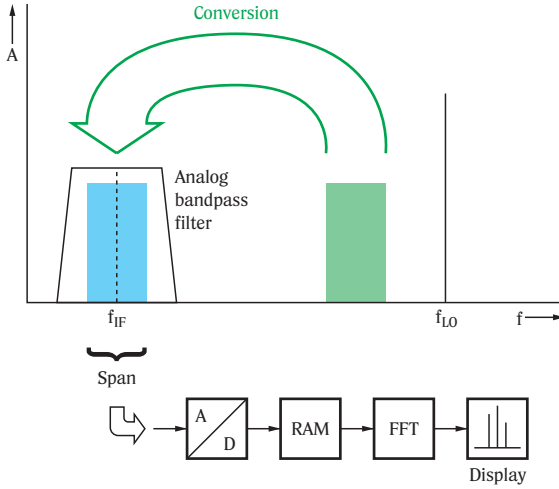

Fig. 4-14 Spectrum analysis using FFT

The maximum span that can be analyzed at a specific resolution by means of an FFT is limited by the sampling rate of the A/D converter and by the memory available for saving the sampled values. Large spans must therefore be subdivided into individual segments which are then converted to the IF in blocks and sampled.

While analog or digital filter sweep times increase directly proportional to the span, the observation time required for FFT depends on the desired frequency resolution as described in chapter 3.1. To comply with sampling principles, more samples have to be recorded for the FFT with increasing span so that the computing time for the FFT also increases. At sufficiently high computing speed of digital signal processing, distinctly shorter measurement times than that of conventional filters can be attained with FFT, especially with high span/RBW ratios (chapter 4.6: Parameter dependencies).

The far-off selectivity of FFT filters is limited by the leakage effect, depending on the windowing function used. The Hann window described in chapter 3.1 is not suitable for spectrum analysis because of the amplitude loss and the resulting level error. A flat-top window is therefore often used to allow the leakage effect to be reduced so that a negligible amplitude error may be maintained. This is at the expense of an observation time that is by a factor of 3.8 longer than that of a rectangular window. The flat-top

window causes a wider representation of the windowing function in the frequency domain (corresponding to the convolution with a Dirac pulse in the frequency domain). When the flat-top window is implemented, a shape factor of about 2.6 can be attained, which means that selectivity is clearly better than when analog or digital IF filters are used.

FFT filters are unsuitable for the analysis of pulsed signals (see chapter 3.1). Therefore it is important for spectrum analyzers to be provided with both FFT and conventional filters.

4.3 Determination of video voltage and video filters

Information about the level of the input signal is contained in the level of the IF signal, such as amplitude-modulated signals in the envelope of the IF signal. With the use of analog and digital IF filters, the envelope of the IF signal is detected after filtering the highest intermediate frequency (see Fig. 4-15).

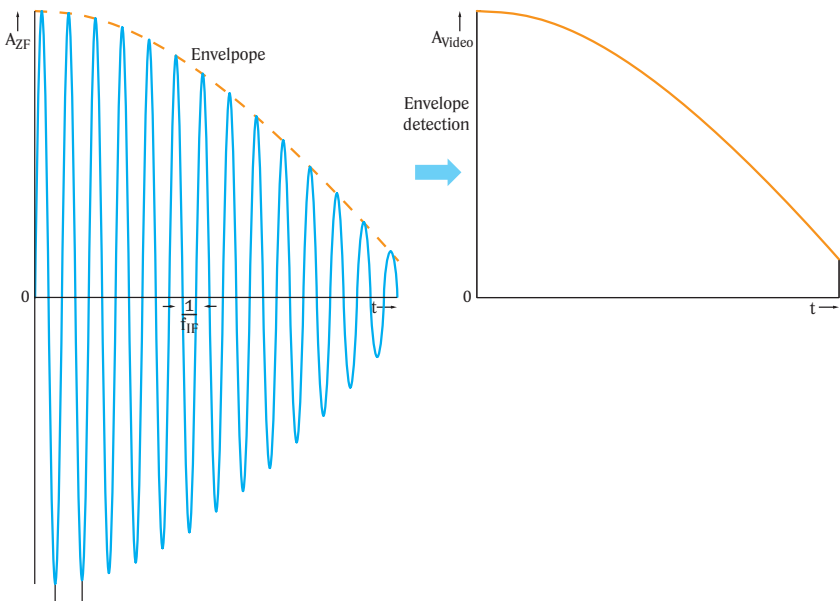

Fig. 4-15 Detection of IF signal envelope

This functional configuration is similar to analog envelope detector circuitry used to demodulate AM signals (see Fig. 4-16). The IF signal is detected and the high-frequency signal component is eliminated by a low-pass filter and the video voltage is available at the output of this circuit.

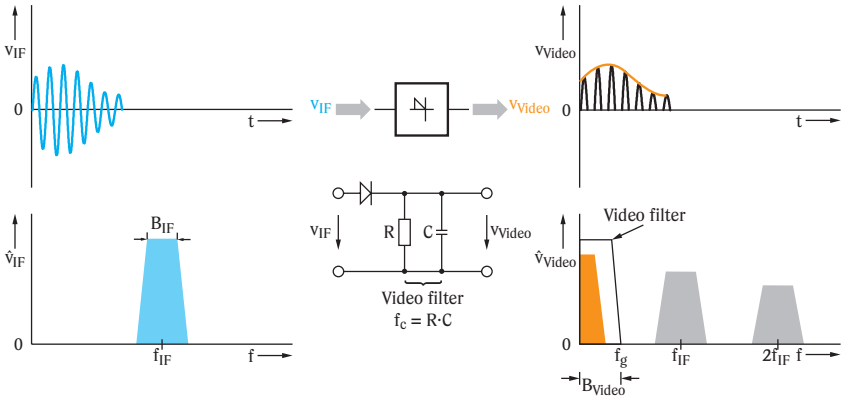

Fig. 4-16 Detection of IF signal envelope by means of envelope detector

For digital bandwidths, the IF signal itself is sampled, so the envelope is determined from the samples after the digital IF filter. If one looks at the IF signal represented by a complex rotating vector (chapter 2.1), the envelope corresponds to the length of the vector rotating at an angular velocity of ω_{IF} (Fig. 4-17). The envelope can be determined by forming the magnitude using the Cordic algorithm [4-3].

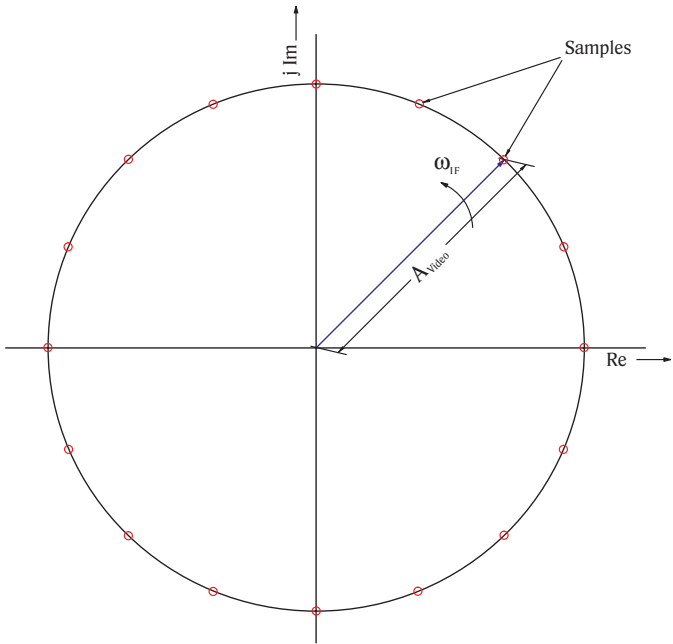

Fig. 4-17 IF signal with sinusoidal input signal, represented by complex rotating vector

Due to envelope detection, the phase information of the input signal gets lost, so that only the magnitude can be indicated in the display. This is one of the primary differences between the envelope detector and the FFT analyzer as described in chapter 3.1.

The dynamic range of the envelope detector determines the dynamic range of a spectrum analyzer. Modern analyzers feature a dynamic range of about 100 dB. The level is usually displayed in a logarithmic scale on the spectrum analyzer. The IF signal can therefore be amplified with the aid of a log amplifier (32) ahead of the envelope detector (33), thereby increasing the dynamic range of the display.

The resulting video voltage depends on the input signal and the selected resolution bandwidth. Fig. 4-18 shows some examples. The spectrum analyzer is tuned to a fixed frequency in these examples, so the displayed span is 0 Hz (zero span).

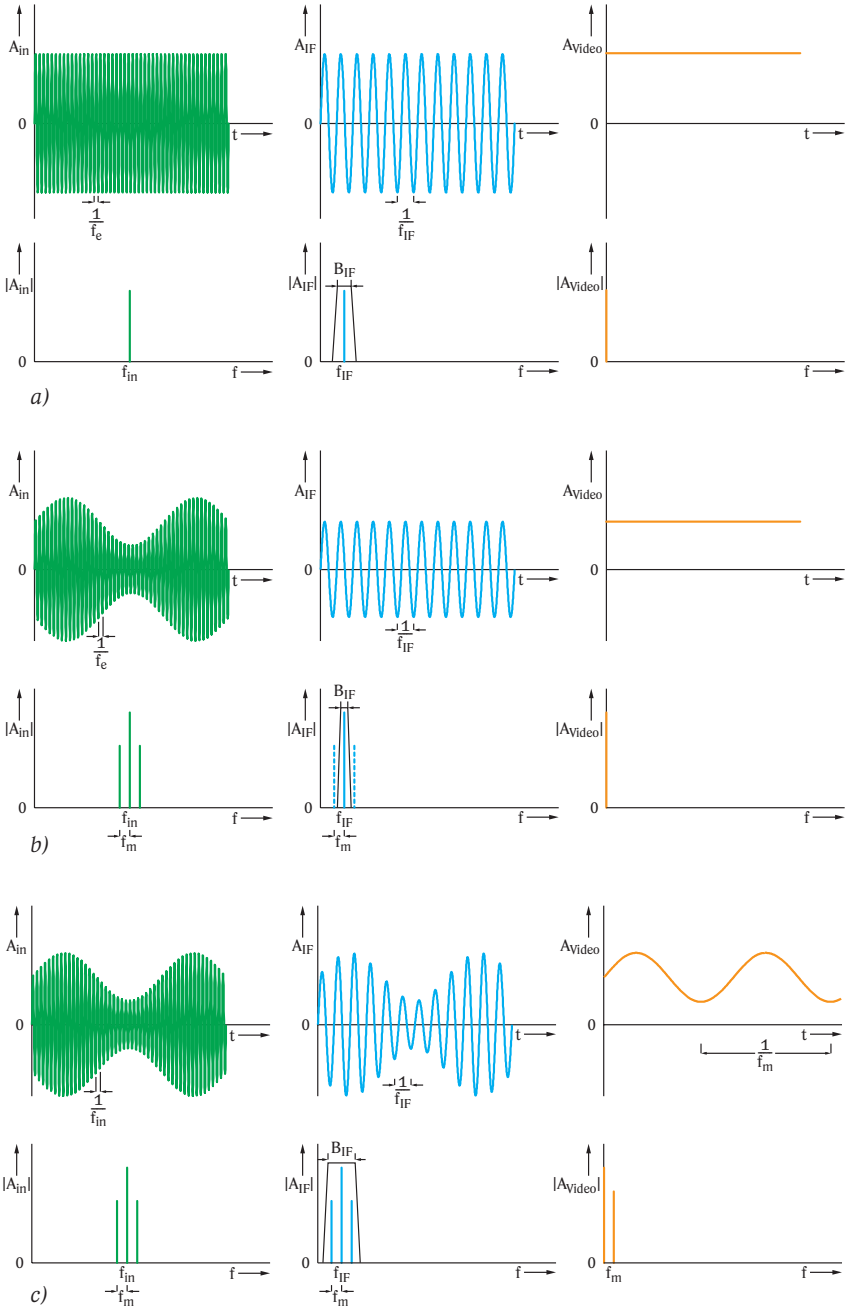
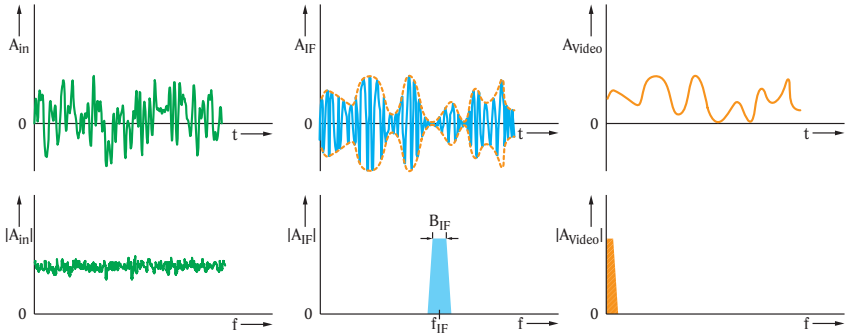

Fig. 4-18 Video signal (yellow trances) and IF signal after IF filter (blue traces) for various input signals (green traces) and resolution bandwidths
 a) sinusoidal signal b) AM signal, resolution bandwidth smaller than twice the modulation bandwidth c) AM signal, resolution bandwidth greater than twice the modulation bandwidth



d)

Fig. 4-18 (continued) Video signal (yellow traces) and IF signal after IF filter (blue traces) for various input signals (green traces) and resolution bandwidths
d) noise

The envelope detector is followed by the video filter (35) which defines the video bandwidth (VBW). The video filter is a first order lowpass configuration used to free the video signal from noise, and to smooth the trace that is subsequently displayed so that the display is stabilized. In the analyzer described, the video filter is implemented digitally. Therefore, the video signal is sampled at the output of the envelope detector with the aid of an A/D converter (34) and its amplitude is quantized.

Similar to the resolution bandwidth, the video bandwidth also limits the maximum permissible sweep speed. The minimum sweep time required increases with decreasing video bandwidth (chapter 4.6.1).

The examples in Fig. 4-18 show that the video bandwidth has to be set as a function of the resolution bandwidth and the specific measurement application. The detector used also has to be taken into account in the video bandwidth setting (chapter 4.5). The subsequent considerations do not hold true for RMS detectors (chapter 4.4: Detectors).

For measurements on sinusoidal signals with sufficiently high signal-to-noise ratio, a video bandwidth that is equal to the resolution bandwidth is usually selected. With a low S/N ratio, the display can be stabilized by reducing the video bandwidth. Signals with weak level are thus shown more distinctly in the spectrum (Fig. 4-19) and the measured level values are thereby stabilized and reproducible. In the case of a sinusoidal signal, the displayed level is not influenced by a reduction of the video bandwidth.

This becomes quite clear when looking at the video voltage resulting from the sinusoidal input signal in Fig. 4-18a. The video signal is a pure DC voltage, so the video filter has no effect on the overall level of the video signal.

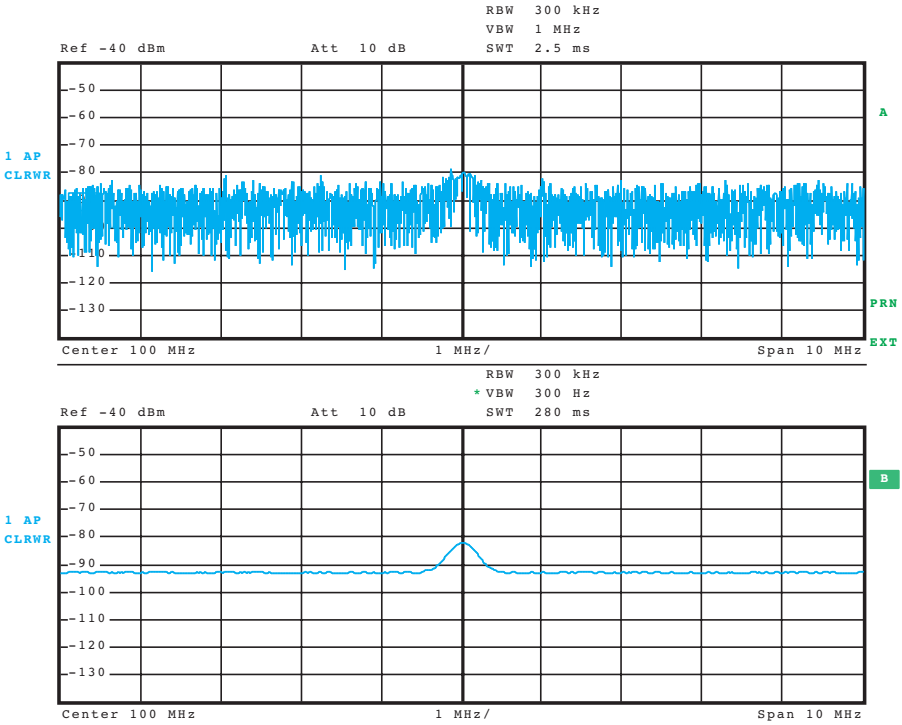

Fig. 4-19 Sinusoidal signal with low S/N ratio shown for large (top) and small (bottom half of screen) video bandwidth

To obtain stable and reproducible results of noise measurements, a narrow video bandwidth should be selected. The noise bandwidth is thus reduced and high noise peaks are averaged. As described in greater detail in chapter 4.4, the displayed average noise level will be 2.5 dB below the signal's RMS value.

Averaging should be avoided when making measurements on pulsed signals. Pulses have a high peak and a low average value (depending on mark-to-space ratio). In order to avoid too low display levels, the video bandwidth should be selected much greater than the resolution bandwidth (Fig. 4-20). This is further discussed in chapter 6.2.

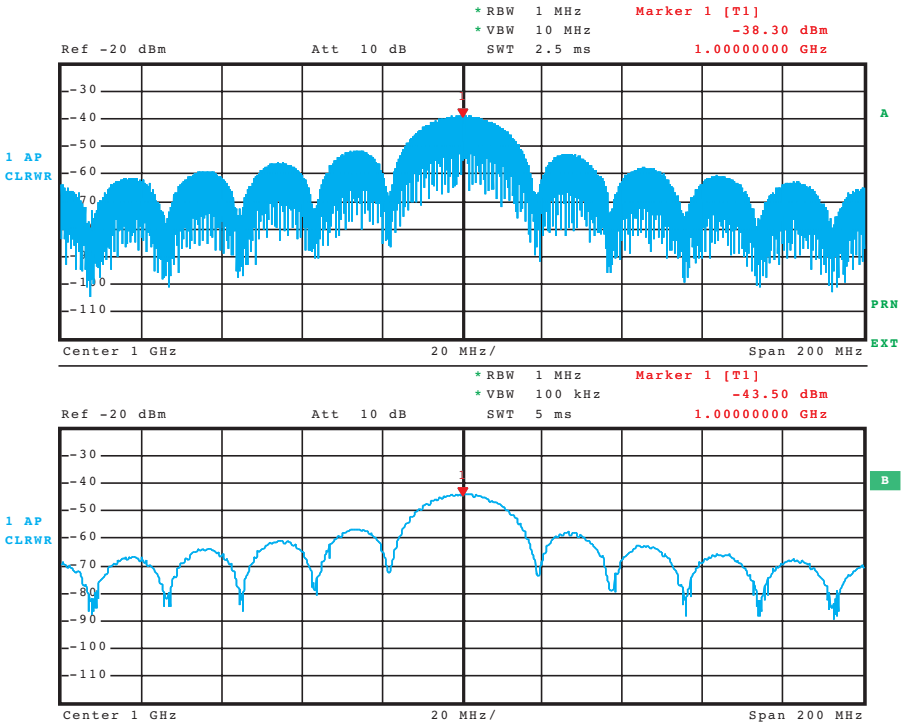

Fig. 4-20 Pulsed signal recorded with large and small video bandwidth (top and bottom half of screen); note amplitude loss with small video bandwidth (see marker)

4.4 Detectors

Modern spectrum analyzers use LC displays instead of cathode ray tubes for the display of the recorded spectra. Accordingly, the resolution of both the level and the frequency display is limited.

The limited resolution of the level display range can be remedied by using marker functions (see chapter 4.5: Trace processing). Results can then be determined with considerably high resolution.

Particularly when large spans are displayed, one pixel contains the spectral information of a relatively large subrange. As explained in chapter 4.1, the tuning steps of the 1st local oscillator depend on the resolution bandwidth so that several measured values, referred to as samples or as bins, fall on one pixel. Which of the samples will be represented by the pixel depends on the selected weighting which is determined by the detector. Most of the spectrum analyzers feature min peak, max peak, auto peak and sample detectors. The principles of the detectors is shown in Fig. 4-21.

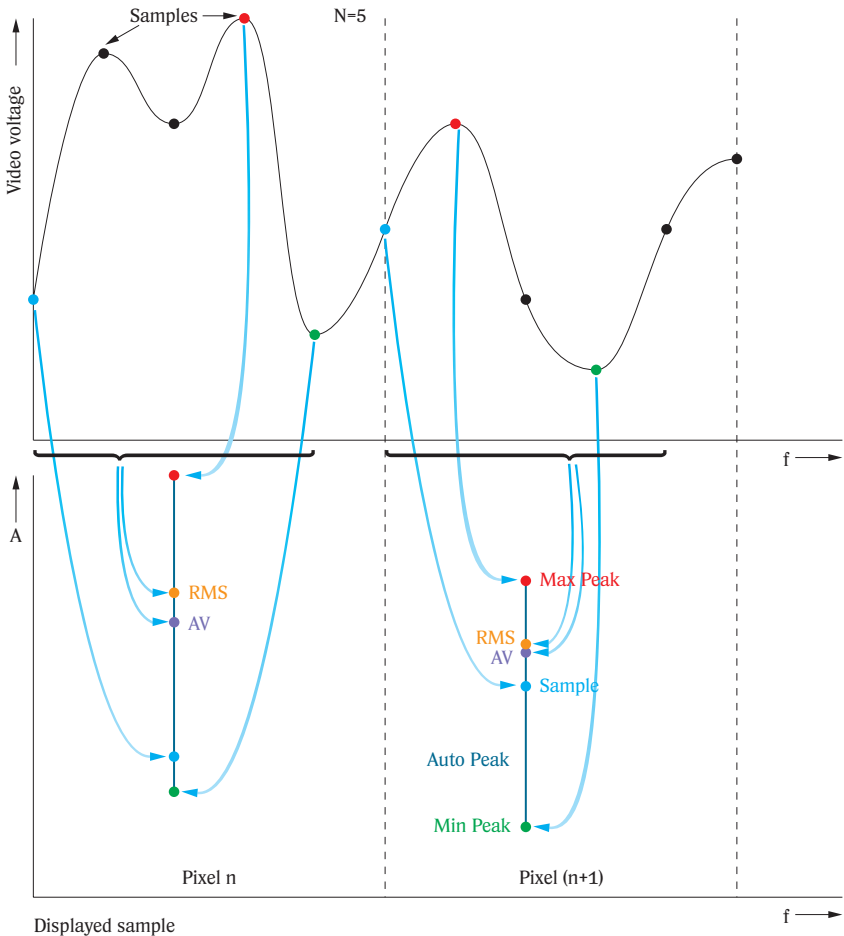

Figs 4-21 Selection of sample to be displayed as a function of detector used

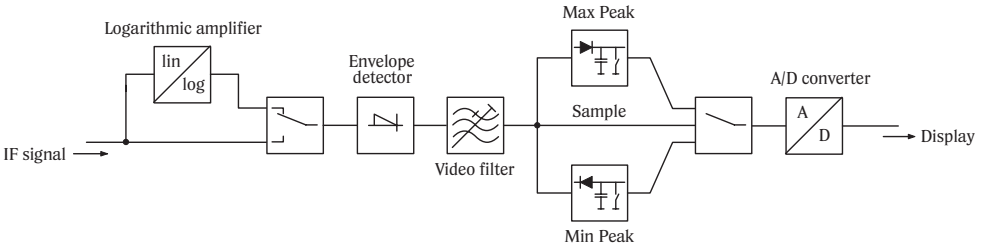

Fig 4-22 Analog realization of detectors

These detectors can be implemented by analog circuits as shown in Fig. 4-22. In this figure, the weighted video signal is sampled at the output of the detector. In the spectrum analyzer described, the detectors (36 - 39) are implemented digitally, so that the video signal is sampled ahead of the detectors (in this case even ahead of the video filter). In addition to the above detectors, average and RMS detectors may also be realized. Quasi-peak detectors for interference measurements are implemented in this way.

• **Max peak detector**

The max peak detector displays the maximum value. From the samples allocated to a pixel the one with the highest level is selected and displayed. Even if wide spans are displayed with very poor resolution bandwidth ($\text{span/RBW} \gg \text{number of pixels on frequency axis}$), no input signals are lost. Therefore this type of detector is particularly useful for EMC measurements.

• **Min peak detector**

The min peak detector selects from the samples allocated to a pixel the one with the minimum value for display.

• **Auto peak detector**

The auto peak detector provides for simultaneous display of maximum and minimum value. The two values are measured and their levels displayed, connected by a vertical line (see Fig. 4-21).

• **Sample detector**

The sample detector samples the IF envelope for each pixel of the trace to be displayed only once. That is, it selects only one value from the samples allocated to a pixel as shown in Fig. 4-21 to be displayed. If the span to be displayed is much greater than the resolution bandwidth (span/RBW > number of pixels on frequency axis), input signals are no longer reliably detected. The same unreliability applies when too large tuning steps of the local oscillator are chosen (see Fig. 4-5). In this case, signals may not be displayed at the correct level or may be completely lost.

• **RMS detector**

The RMS (root mean square) detector calculates the power for each pixel of the displayed trace from the samples allocated to a pixel. The result corresponds to the signal power within the span represented by the pixel. For the RMS calculation, the samples of the envelope are required on a linear level scale. The following applies:

$$V_{RMS} = \sqrt{\frac{1}{N} \cdot \sum_{i=1}^N v_i^2} \tag{Equation 4-11}$$

- where V_{RMS} = RMS value of voltage, in V
- N = number of samples allocated to the pixel concerned
- v_i = samples of envelope, in V

The reference resistance R can be used to calculate the power:

$$P = \frac{V_{RMS}^2}{R} \tag{Equation 4-12}$$

• **AV detector**

The AV (average) detector calculates the linear average for each pixel of the displayed trace from the samples allocated to a pixel. For this calculation the samples of the envelope are required on a linear level scale. The following applies:

$$V_{AV} = \frac{1}{N} \cdot \sum_{i=1}^N v_i \tag{Equation 4-13}$$

where V_{AV} = average voltage, in V
 N = number of samples allocated to the pixel concerned
 v_i = samples of the envelope, in V

Like with the RMS detector, the reference resistance R can be used to calculate the power (Equation 4-12).

• **Quasi peak detector**

This is a peak detector for interference measurement applications with defined charge and discharge times. These times are laid down by CISPR 16-1 [4-4] for instruments measuring spurious emission. A detailed description of this type of detector can be found in chapter 6.2.5.1.

With a constant sampling rate of the A/D converter, the number of samples allocated to a certain pixel increases at longer sweep times. The effect on the displayed trace depends on the type of the input signal and the selected detector. They are described in the following section.

Effects of detectors on the display of different types of input signals

Depending on the type of input signal, the different detectors partly provide different measurement results. Assuming that the spectrum analyzer is tuned to the frequency of the input signal (span = 0 Hz), the envelope of the IF signal and thus the video voltage of a sinusoidal input signal with sufficiently high signal-to-noise ratio are constant. Therefore, the level of the displayed signal is independent of the selected detector since all samples exhibit the same level and since the derived average value (AV detector) and RMS value (RMS detector) correspond to the level of the individual samples.

This is different however with random signals such as noise or noise-like signals in which the instantaneous power varies with time. Maximum and minimum instantaneous value as well as average and RMS value of the IF signal envelope are different in this case.

The power of a random signal is calculated as follows:

$$P = \frac{1}{R} \cdot \lim_{T \rightarrow \infty} \left(\frac{1}{T} \cdot \int_{-\frac{T}{2}}^{+\frac{T}{2}} v^2(t) dt \right) \quad (\text{Equation 4-14})$$

or for a certain limited observation time T

$$P = \frac{1}{R} \cdot \frac{1}{T} \cdot \int_{t-\frac{T}{2}}^{t+\frac{T}{2}} v^2(t) dt \quad (\text{Equation 4-15})$$

In the given observation time T, a peak value can also be found for the instantaneous power. The relationship between the peak value and power can be expressed by the crest factor as follows:

$$CF = 10 \cdot \log \left(\frac{P_s}{P} \right) \quad (\text{Equation 4-16})$$

where CF = crest factor, in dB
 P_s = peak value of instantaneous power in observation time T, in W
 P = power, in W

With noise, any voltage values may occur theoretically, so the crest factor would be arbitrarily high. Since the probability for very high or very low voltage values is low, a crest factor of about 12 dB is usually obtained in practice for Gaussian noise observed over a sufficiently long period.

Digitally modulated signals often exhibit a spectrum similar to noise. However, the crest factor usually differs from that for Gaussian noise. Fig. 4-23 shows the peak and RMS values of Gaussian noise and of a IS-95 CDMA signal (forward channel).

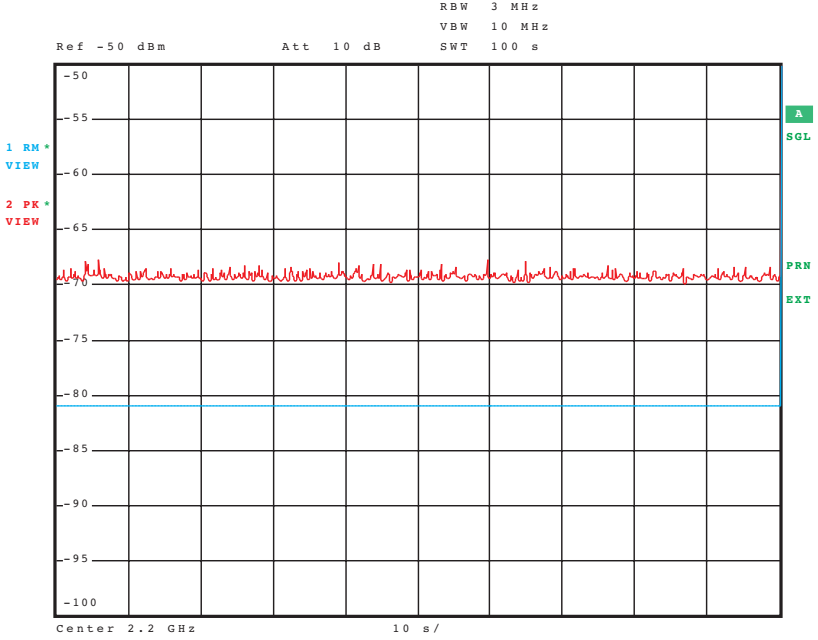

a) Crest factor 12 dB

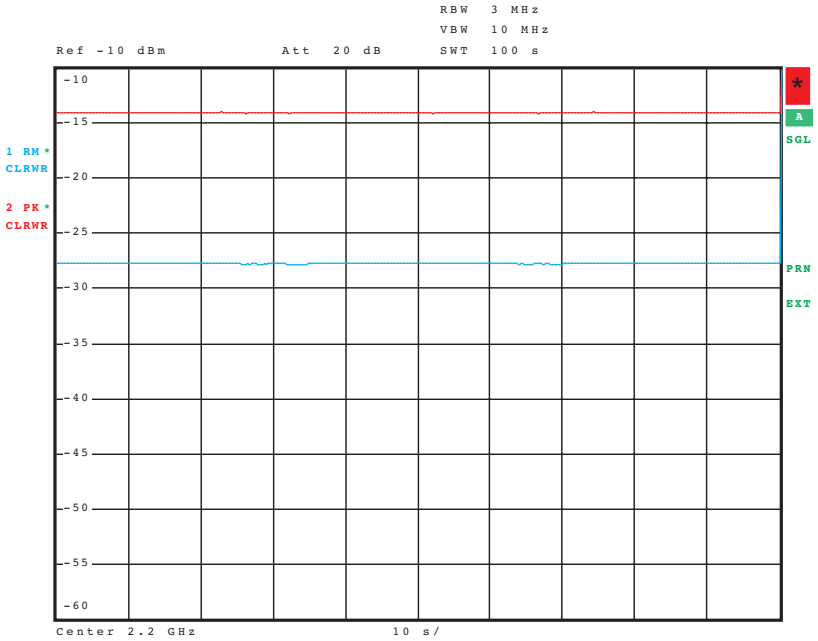

b) Crest factor 13.8 dB

Fig. 4-23 Peak (red traces) and RMS values (blue traces) of Gaussian noise (a) and of a IS-95 CDMA signal (b), recorded with max peak and RMS detectors

The effects of the selected detector and of the sweep time on the results of measurements on stochastic signals are described in the following.

- **Max peak detector**

When using the max peak detector, stochastic signals are overweighted so that the maximum level is displayed. With increasing sweep time the dwell time in a frequency range allocated to a pixel is also increased. In the case of Gaussian noise the probability that higher instantaneous values will occur also rises. This means that the levels of the displayed pixels also become higher (see Fig. 4-24a).

With a small ratio between span and resolution bandwidth, the noise displayed for short sweep times is equal to that displayed with a sample detector, since only one sample is recorded per pixel.

- **Min peak detector**

When using the min peak detector, stochastic signals are underweighted so that the minimum level is displayed. The noise displayed on the spectrum analyzer is strongly suppressed. In the case of Gaussian noise the probability that lower instantaneous values will occur increases with increasing sweep time. This means that the levels of the displayed pixels also become lower (see Fig. 4-24a).

If measurements are carried out on sinusoidal signals with low signal-to-noise ratio, the minimum of the noise superimposed on the signal will also be displayed so that the level measurements yield too low values.

With a small ratio between span and resolution bandwidth, the noise displayed for short sweep times is equal to that displayed with a sample detector, since only one sample is recorded per pixel.

- **Auto peak detector**

When using the auto peak detector, the results of the max peak and min peak detectors are displayed simultaneously, the two values being connected by a line. With increasing sweep time the displayed noise band becomes distinctly wider.

With a small ratio between span and resolution bandwidth, the noise displayed for short sweep times is equal to that displayed with a sample detector, since only one sample is recorded per pixel.

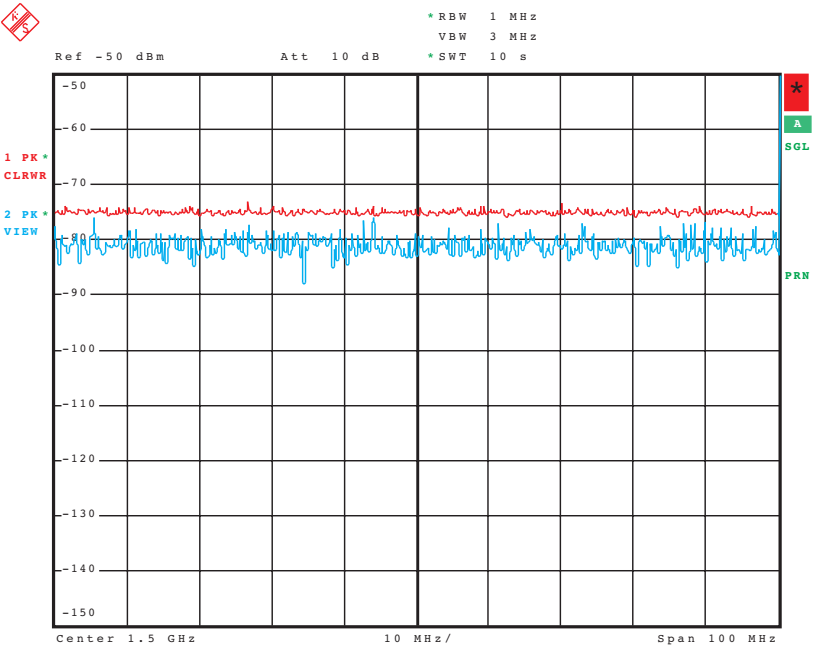

a)

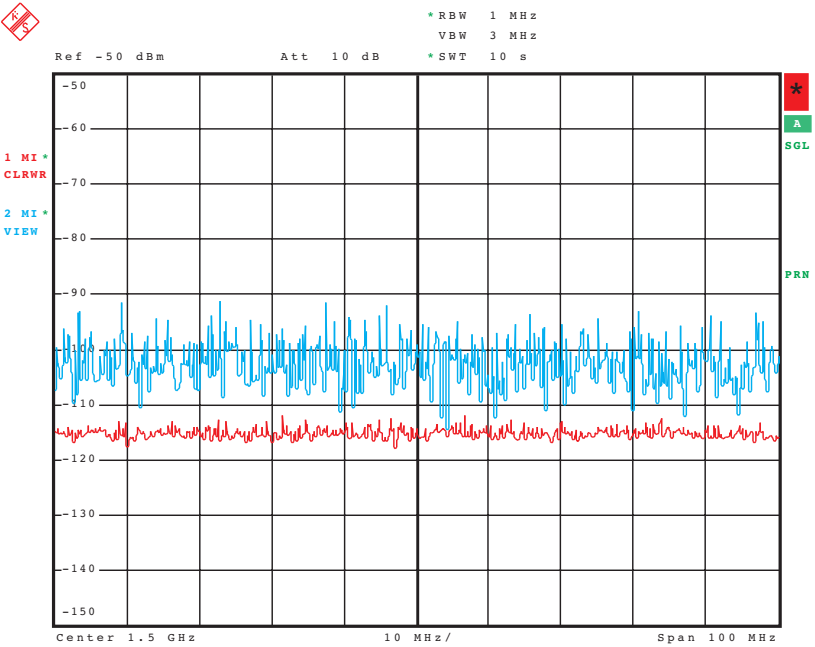

b)

Fig. 4-24 Displayed noise varying as a function of sweep time, with max peak detector (a) and min peak detector (b), sweep time 2.5 ms (blue trace) and 10 s (red trace)

- **Sample detector**

As shown in Fig. 4-21, the sample detector always displays a sample recorded at a defined point in time. Due to the distribution of the instantaneous values, the trace displayed in the case of Gaussian noise therefore varies about the average value of the IF signal envelope resulting from noise. This average value is 1.05 dB below the RMS value. If noise is averaged over a narrow video bandwidth ($VBW < RBW$) using the logarithmic level scale, the displayed average value is an additional 1.45 dB too low. The displayed noise is then 2.5 dB below the RMS value.

In contrast to the other detectors the sweep time has no effect on the displayed trace since the number of the recorded samples is independent of the sweep time.

- **RMS detector**

The RMS detector allows measurement of the actual power of an input signal irrespective of its temporal characteristic. When using a sample or max peak detector, the relationship between RMS value and peak value must be precisely known for determining the power of signals with random instantaneous value. This knowledge is not required when using an RMS detector.

The RMS value displayed by a specific pixel is calculated from all samples pertaining to this pixel. By increasing the sweep time, the number of samples available for the calculation is increased, thus allowing smoothing of the displayed trace. Smoothing by reducing the video bandwidth or by averaging over several traces (see chapter 4.5) is neither permissible nor necessary with the RMS detector. The measurement results would be falsified, since the displayed values would be too low (max. 2.51 dB).

To avoid any falsification of results, the video bandwidth should be at least three times the resolution bandwidth when using the RMS detector.

- **AV detector**

The AV detector determines the average value from the samples using the linear level scale. The actual average value is thus obtained irrespective of the type of input signal. Averaging of logarithmic samples (log average) would yield results that were too low since higher signal levels are subject to greater compression by logarithmation. By increasing the

sweep time, several samples are available for calculating the average value that is displayed by a specific pixel. The displayed trace can thus be smoothed.

A narrow video bandwidth causes averaging of the video signal. If samples of the linear level scale are applied to the input of the video filter, the linear average of the samples is formed when reducing the video bandwidth. This corresponds to the function of the AV detector so that smoothing by means of narrow video bandwidths is permissible in this case.

The same holds true for the analyzer described here, since samples with linear level scale are applied to the input of the video filter when the AV detector is used (see block diagram).

If the video bandwidth is reduced, the displayed noise converges for max peak, min peak, auto peak and sample detectors since the samples are averaged by the video filter before they are weighted by the detector. If a linear envelope detector is used to determine the IF signal envelope, samples with linear scale are averaged by the video filter. The resulting display corresponds to the true average value and hence to the displayed noise when using an AV detector. If the IF signal is log-amplified before the video voltage is formed, the resulting averaged samples are lower than the true average value. In the case of Gaussian noise the difference is 1.45 dB (see Fig. 4-25a). Since the linear average of the video voltage resulting from Gaussian noise is already 1.05 dB below the RMS value, the samples obtained are all 2.5 dB lower than those obtained with the RMS detector (see Fig. 4-25a). Due to this known relationship an RMS detector is not required to determine the Gaussian noise power. The power can be calculated from the samples collected by the sample detector, taking into account a correction factor of 2.5 dB.

This relationship does not apply to other random signals whose instantaneous values are not in line with the Gaussian distribution (for example, digitally modulated signals, see Fig. 4-25b). If the crest factor is unknown, the power of such signals can only be determined using an RMS detector.

Averaging over several measurements

As described in the following chapter, modern analyzers feature the possibility of averaging traces over several measurements (trace average). This method of averaging partly leads to results different from those when using narrowband video filters.

Depending on whether the recorded trace is displayed on a linear or logarithmic level scale, linear or logarithmic samples are used for averaging. Whether the trace is falsified by averaging depends on the display mode.

In the case of averaging over several measurements, the displayed noise levels do not converge for max peak, min peak and sample detectors. The average is derived from the maximum and minimum values, whereas with the use of the video filter, the samples are averaged prior to weighting and therefore converge.

The sample detector yields the average noise level. With logarithmic level display, the displayed average value is 1.45 dB too low, as already explained above. With linear level display and large video bandwidth ($VBW \geq 10 \cdot RBW$) the true average is obtained, as with the AV detector.

When using the auto peak detector, averaging over several traces is not recommended since the maximum and minimum value is displayed. When the trace average function is activated, automatic switchover to sample detector is often made.

For the RMS detector, trace averaging is permitted neither in the linear nor in the logarithmic level mode.

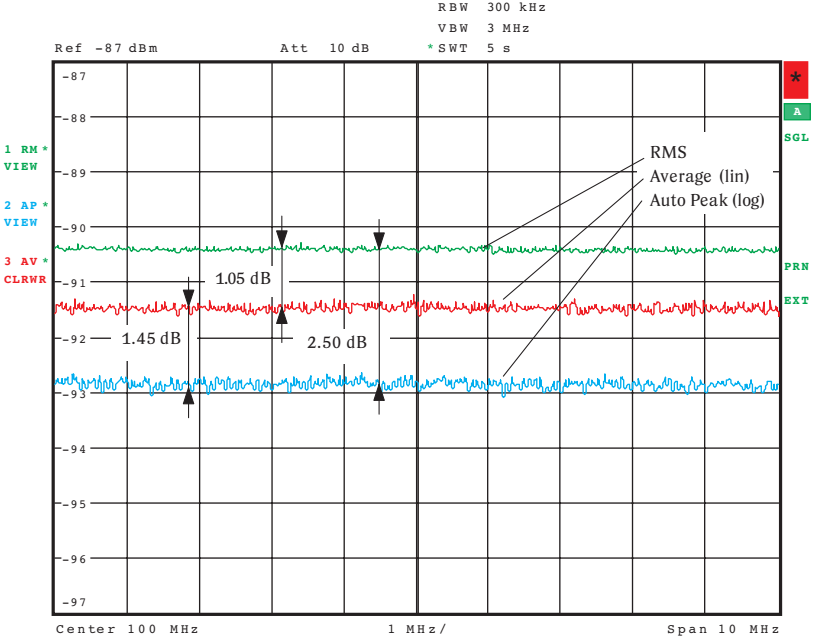

a)

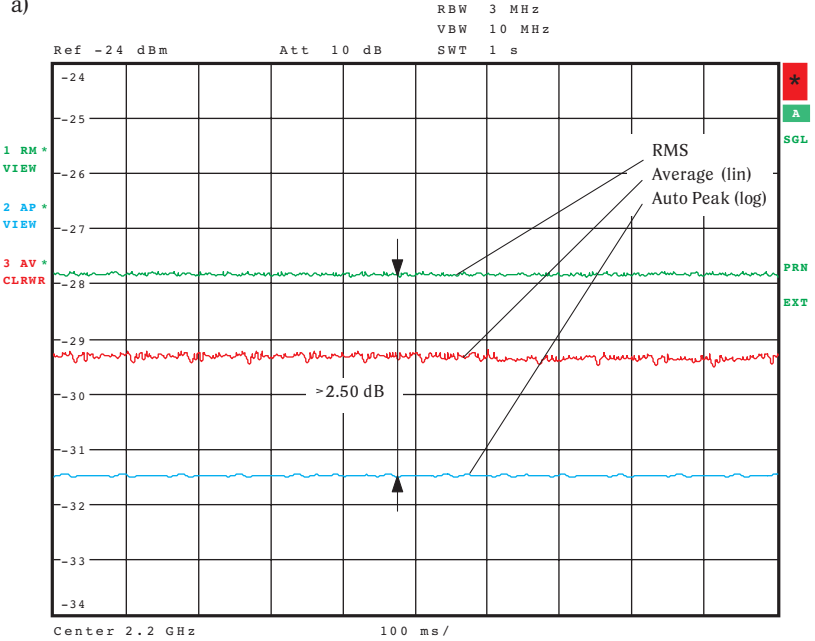

b)

Fig. 4-25 Measurement of Gaussian noise (a) and IS-95 CDMA signal (b) using RMS and AV detectors (green and red trace) as well as auto peak detector with averaging over narrow video bandwidth (blue trace)

4.5 Trace processing

As was explained in chapter 4.4, linear samples are required for AV and RMS detectors. For displaying the traces on a logarithmic level scale when these detectors are used, the detectors are followed by a log amplifier (40) which may be optionally activated.

In modern spectrum analyzers, the measurement results are digitized before they are displayed. This allows many different methods of trace evaluation (41).

- **Measured data memory**

Several traces can be stored in modern analyzers and simultaneously displayed. This function is particularly useful for comparative measurements.

- **Trace average**

With the aid of this function a displayed trace can be smoothed by averaging over several measurements (sweeps). The user can enter the number of sweeps to be averaged.

Depending on the input signal and the detector used, this way of averaging may lead to other results than averaging by reducing the video bandwidth.

- **Marker functions**

Marker functions are particularly useful for the evaluation of recorded traces. They allow frequency and level to be displayed at any point of the trace. The limited display accuracy due to the constrained screen resolution can thus be remedied. In addition to functions which set the marker automatically to a signal's level, level differences between signals can also be directly displayed using the delta marker feature.

Modern spectrum analyzers feature enhanced marker functions allowing, for instance, direct noise or phase noise measurements, without manual setting of bandwidth or correction factors (see Fig. 4-26).

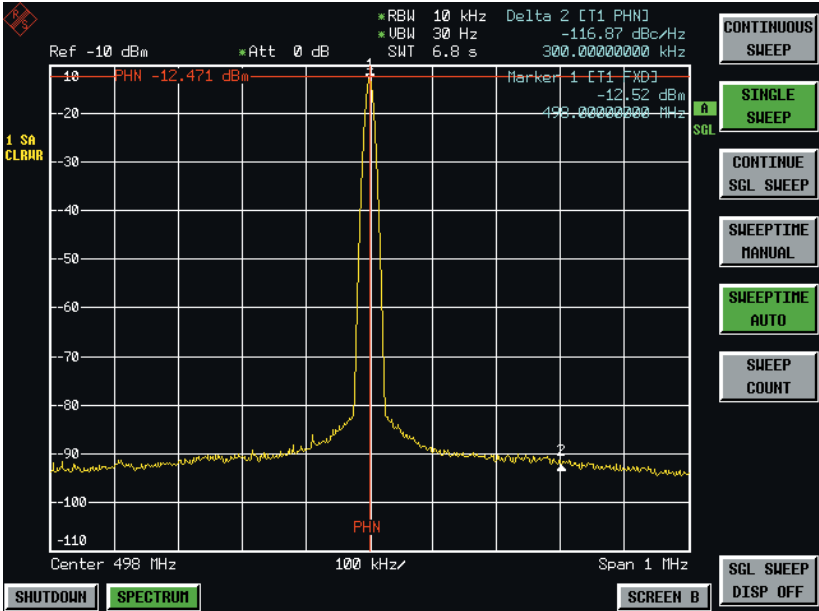

Fig. 4-26 Marker functions for easy phase noise measurement of an input signal

The precise frequency of a displayed signal can also be determined with the aid of a marker and a count function (signal count). In many cases the spectrum analyzer can thus replace a frequency counter.

• **Tolerance masks (limit lines)**

Limit values to be adhered to by the device under test can easily be checked with the aid of tolerance masks. To simplify use in production, recorded traces are automatically checked for violation of the specified limit values and the result is output in form of a “pass” or “fail” message (see Fig. 4-27).

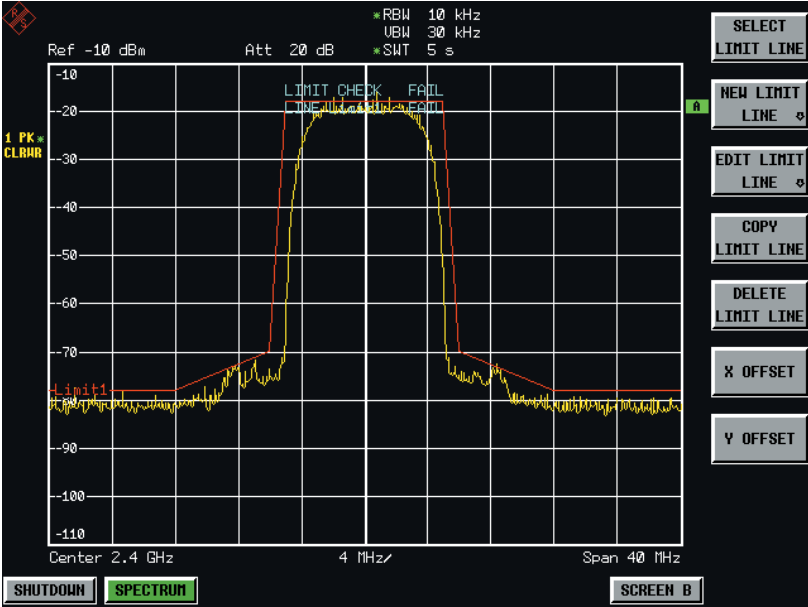

Fig. 4-27 Evaluation of traces with the aid of limit lines

• **Channel power measurement**

In the case of digitally modulated signals, power often has to be measured within one channel or within a specific frequency range. Channel power is calculated from the recorded trace, with special functions being provided for this purpose by modern spectrum analyzers. Adjacent-channel power measurement with the aid of a spectrum analyzer is described in detail in chapter 6.3.

4.6 Parameter dependencies

Some of the analyzer settings are interdependent. To avoid measurement errors, these parameters are coupled to one another in normal operating mode of modern spectrum analyzers. That is, upon varying one setting all other dependent parameters will be adapted automatically. The parameters can, however, also be set individually by the user. In such a case it is especially important to know relationships and effects of various settings.

4.6.1 Sweep time, span, resolution and video bandwidths

Through the use of analog or digital IF filters, the maximum permissible sweep speed is limited by the transient time of the IF filter and video filter. The transient time has no effect if the video bandwidth is larger than the resolution bandwidth. In this case, the required transient time increases inversely with the square of the resolution bandwidth, so with a decrease of the resolution bandwidth by the factor n the required minimum sweep time becomes n^2 longer. The following applies:

$$T_{Sweep} = k \cdot \frac{\Delta f}{B_{IF}^2} \quad (\text{Equation 4-17})$$

- where
- T_{Sweep} = minimum sweep time required (with given span and resolution bandwidth), in s
 - B_{IF} = Resolution bandwidth, in Hz
 - Δf = span to be displayed, in Hz
 - k = proportionality factor

The proportionality factor k depends on the type of filter and the permissible transient response error. For analog filters made up of four or five individual circuits, the proportionality factor k is 2.5 (maximum transient response error approx. 0.15 dB). With digitally implemented Gaussian filters, the transient response is known and exactly reproducible. Compared to analog filters, higher sweep speeds without amplitude loss can be obtained through appropriate correction factors independent of the type of input signal. A k factor of 1 can thus be attained. Fig. 4-28 shows the required sweep time for a span of 1 MHz as a function of the resolution bandwidth.

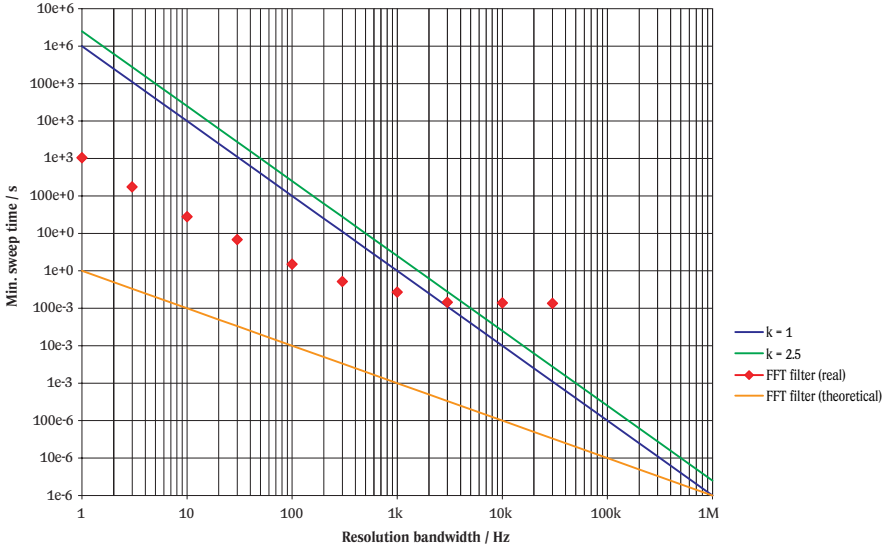

Fig. 4-28 Theoretically required sweep time as a function of resolution bandwidth at a span of 1 MHz. Example of sweep times that can be attained with FFT filters in a modern spectrum analyzer

If the video bandwidth is smaller than the resolution bandwidth, the required minimum sweep time is influenced by the transient time of the video filter. Similar to the IF filter, the transient time of the video filter increases with decreasing bandwidth. The video filter is usually a 1st order lowpass, or a simple RC section if implemented in analog form. Therefore there is a linear relationship between video bandwidth and sweep time. Reducing the video bandwidth by a factor n results in an n times longer sweep time.

Upon failure to attain the minimum sweep time, the IF filter or video filter cannot reach steady state, causing an amplitude loss and distorted signal display (frequency offset). A sinusoidal signal, for instance, would be displayed neither at the correct level nor correct frequency (see Fig. 4-29). Moreover, the effective resolution would be degraded due to the widened signal display.

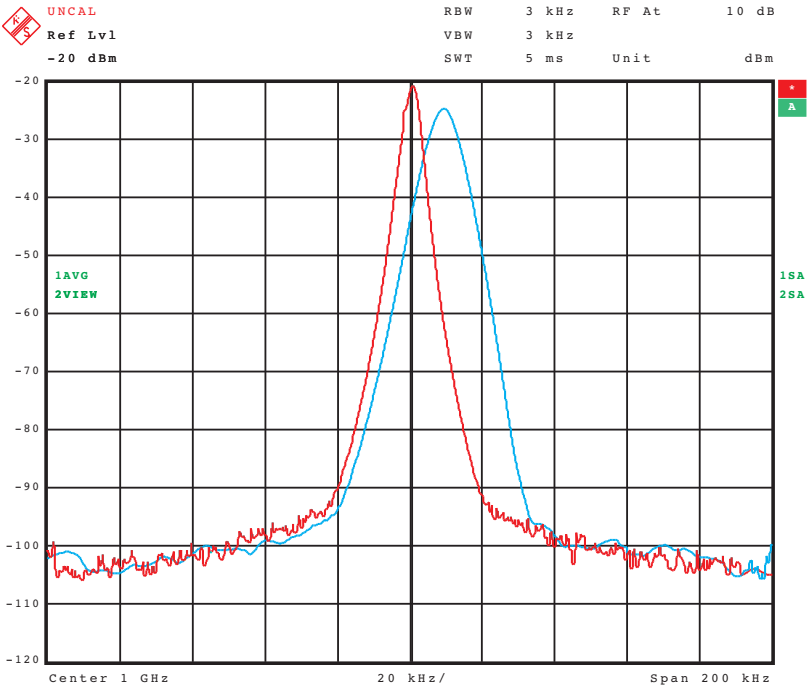

Fig. 4-29 Amplitude loss if minimum sweep time required is not attained (blue trace)

To avoid measurement errors due to short sweep times, resolution bandwidth, video bandwidth, sweep time and span are coupled in normal operating mode of modern spectrum analyzers.

Resolution bandwidth is automatically adapted to the selected span. Long sweep times due to narrow resolution bandwidths at large spans or poor resolution due to high resolution bandwidths at small spans are thus avoided. Handling of a spectrum analyzer becomes much easier. The coupling ratio between span and resolution bandwidth can often be set by the user.

Partial coupling of the parameters is also possible. With manual setting of the resolution and video bandwidths, the sweep time can, for instance, be adapted automatically.

When using manual settings, if the minimum sweep time is not adhered to, a warning is usually displayed (UNCAL in Fig. 4-29 upper left corner).

With FFT filters, the transient time is replaced by the observation time required for a specific resolution (Equation 3-4). In contrast to the sweep time with analog or digital filters, the observation time is independent of the span, so even if the span were increased, the observation time would not be increased for constant resolution. The observation time as a function of the resolution (yellow trace) shown in Fig. 4-28 is therefore independent of the span.

In practice, larger spans are made up of several subranges. At a given resolution, the resulting observation time is required for each subrange. The total observation time is directly proportional to the number of subranges. The attainable measurement time therefore is distinctly longer than the theoretically expected one. Fig. 4-28 shows sweep times that can be attained with a modern spectrum analyzer using FFT filters. It is clearly shown that high span-to-resolution bandwidth ratios allow greatly reduced sweep times with FFT filters, especially when using very narrow resolution bandwidths.

In modern spectrum analyzers, the video bandwidth can be coupled to the resolution bandwidth. When varying the IF bandwidth, the video bandwidth is automatically adapted. The coupling ratio (the ratio between resolution and video bandwidth) depends on the application mode and therefore has to be set by the user (see chapter 4.3). In addition to the user-defined entry of a numeric value, the following options are often available:

- Sine RBW/VBW = 0.3 to 1
- Pulse RBW/VBW = 0.1
- Noise RBW/VBW = 10

In the default setting, the video bandwidth is usually selected so that maximum averaging is achieved without increasing the required sweep time with the video filter. With a proportionality factor $k = 2.5$ (Equation 4-17), the video bandwidth must be at least equal to the resolution bandwidth ($RBW/VBW = 1$). If the IF filter is implemented digitally, a proportionality factor $k = 1$ can be attained through appropriate compensation as described above, and the minimum sweep time required can be reduced by

a factor of 2.5. To ensure steady state of the video filter despite the reduced sweep time, the video bandwidth selected should be about three times greater than the resolution bandwidth ($RBW/VBW = 0.3$).

4.6.2 Reference level and RF attenuation

Spectrum analyzers allow measurements in a very wide level range that is limited by the inherent noise and the maximum permissible input level (see chapter 5.1 and chapter 5.4 1). With modern analyzers this level range may extend from -147 dBm to $+30$ dBm (with a resolution bandwidth of 10 Hz), thus covering almost 180 dB. It is not possible, however, to reach the two range limits at a time since they require different settings and the dynamic range of log amplifiers, envelope detectors and A/D converters is very small. Within the total level range, only a certain window can be used which must be adapted by the user to the specific measurement application by selecting the reference level (maximum signal level to be displayed). The RF attenuation a_{RF} and the IF gain g_{IF} are automatically adjusted as a function of the reference level.

To avoid overdriving or even damaging the first mixer and subsequent processing stages, the high-level input signals must be attenuated by the analyzer's attenuator (see Fig. 4-30). The attenuation required for a given reference level depends on the dynamic range of the first mixer and subsequent stages. The level at the input of the first mixer should be distinctly below its 1 dB compression point. Due to nonlinearities, products are generated in the spectrum analyzer whose levels increase with increasing mixer level. If the mixer level is too high, these products may cause interference in the displayed spectrum so that the intermodulation-free range will be reduced.

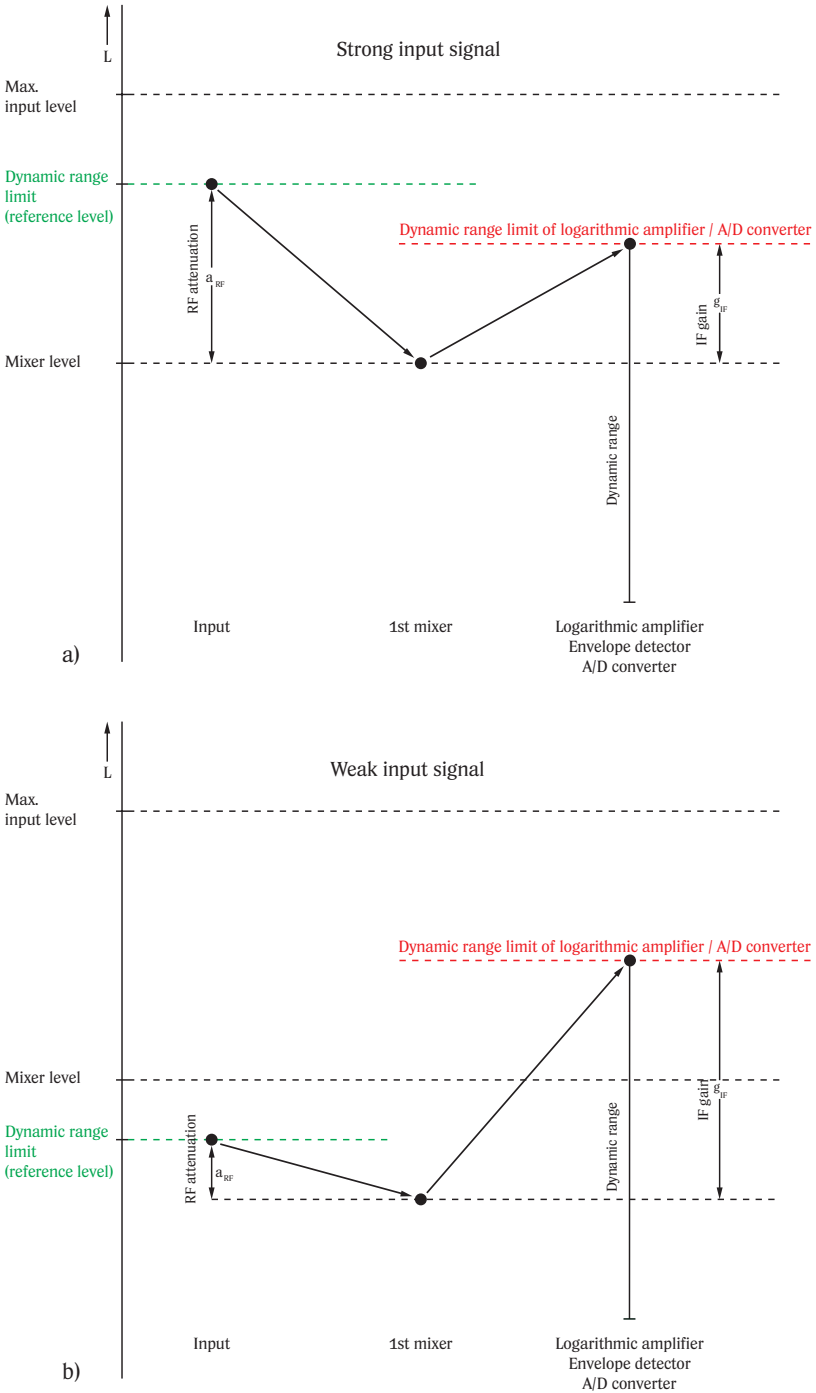
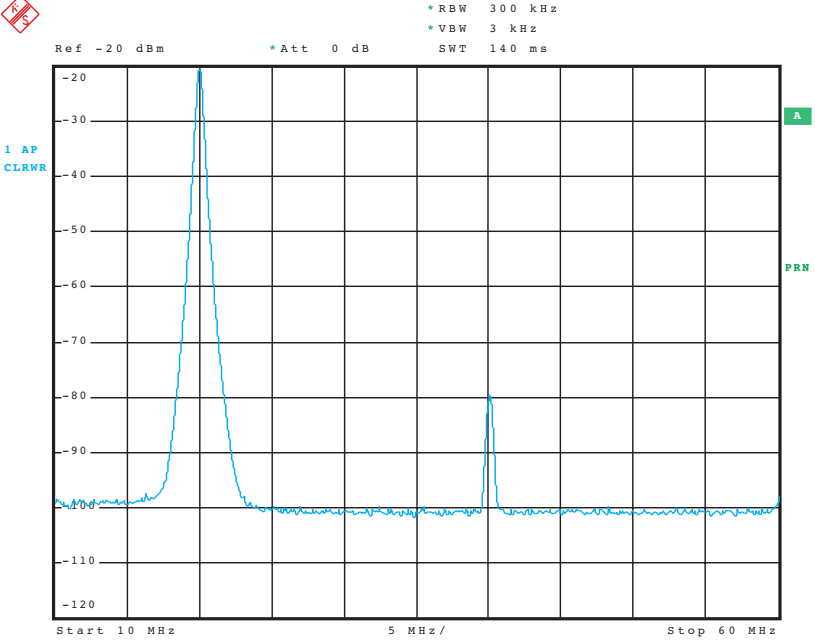
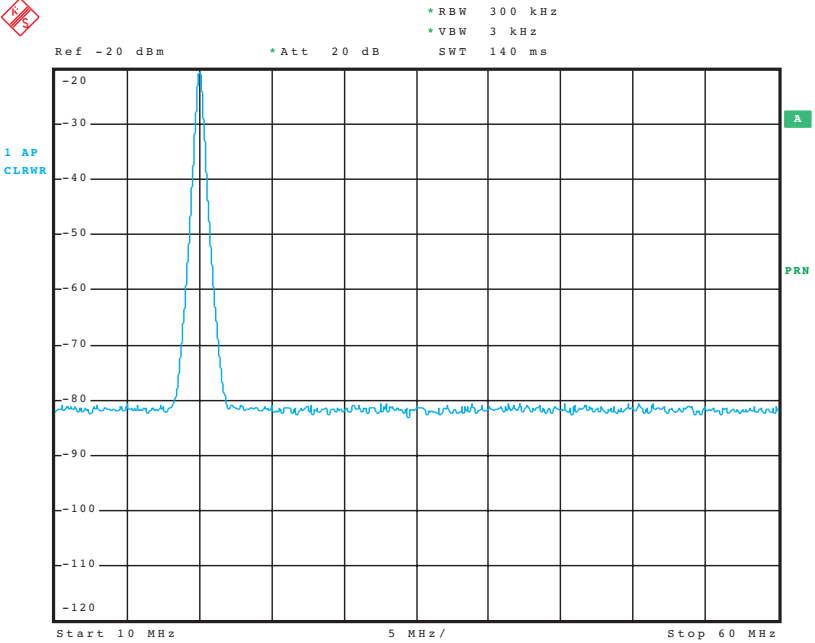

Fig. 4-30 Adaptation of RF attenuation and IF gain to maximum signal level to be displayed (max. signal level = reference level)



a)



b)

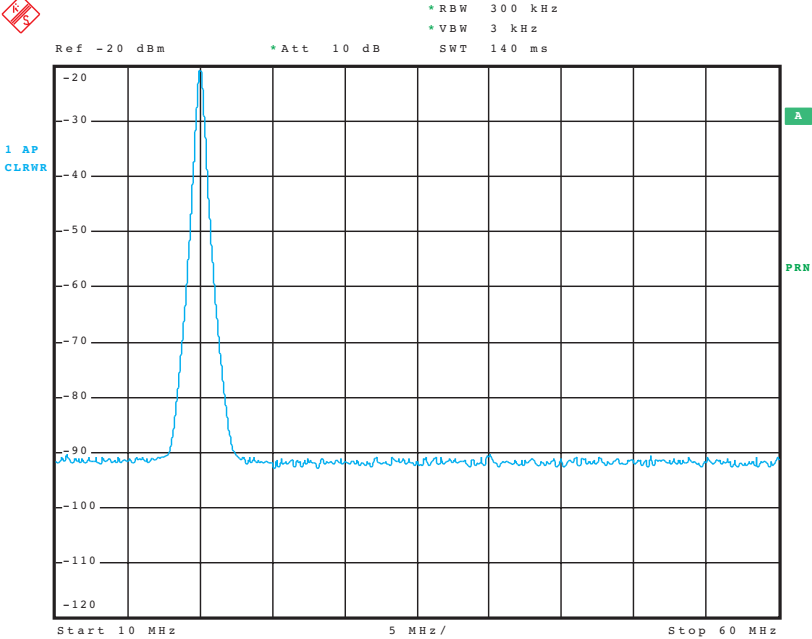

c)

Fig. 4-31 Single-tone input: dynamic range reduced by too high (a) or too low (b) mixer level. Dynamic range attainable with optimum mixer level (c) shown in comparison

If the RF attenuation is too high, causing the mixer level to be too low, the signal-to-noise ratio of the input signal will be unnecessarily reduced. As shown in Fig. 4-32, the attainable dynamic range is then reduced by the higher noise floor. Fig. 4-31 shows the effects of the mixer level with single-tone input (see chapter 5.2: Nonlinearities).

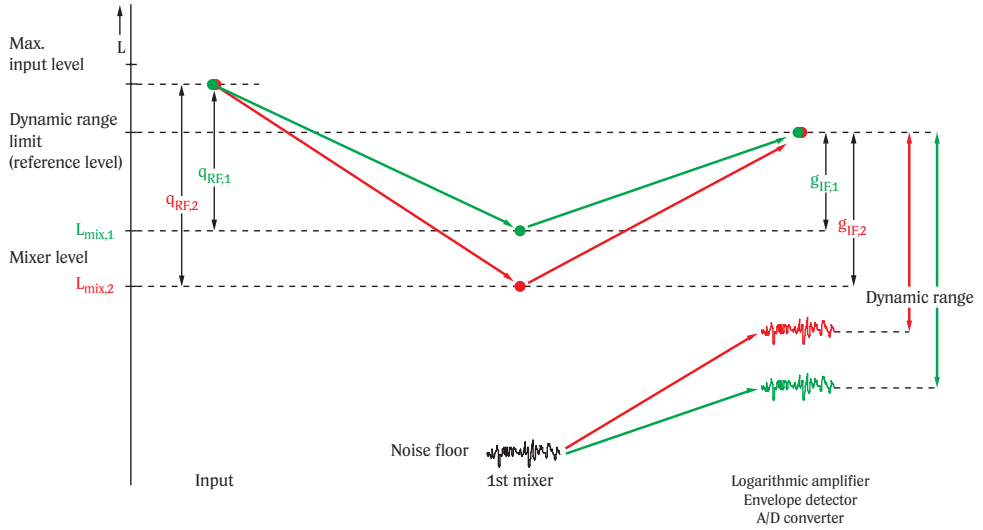

Fig. 4-32 Dynamic range limited by noise floor as a function of mixer level

To obtain the total dynamic range of the log amplifier and envelope detector (with analog IF filters) or of the A/D converter (with digital IF filters), the signal level is appropriately amplified with the aid of the IF amplifier at the last IF. The gain is selected so that signals attaining the reference level cause the full drive of the log amplifier, envelope detector (with linear level display) or A/D converter (with digital IF filters). The IF gain is therefore set indirectly via the reference level although it is also dependent on the selected attenuator. At a constant reference level, the IF gain has to be increased with increasing RF attenuation (see $g_{IF,1}$ and $g_{IF,2}$ in Fig. 4-32).

If the level of the input signal to be displayed exceeds the reference level, this may cause overdriving. The IF gain has then to be reduced by increasing the reference level.

Coupling of reference level and RF attenuation

In modern spectrum analyzers, the RF attenuation can be coupled to the reference level setting. The coupling criterion is the maximum mixer level attained by an input signal whose level corresponds to the reference level. The mixer level attained with full drive therefore results from the difference between reference level and RF attenuation. The following applies:

$$L_{mix} = L_{in,max} - a_{RF} = L_{Ref} - a_{RF} \quad \text{(Equation 4-18)}$$

where

L_{mix}	=	level at input of first mixer with full drive, in dBm
$L_{in,max}$	=	input level causing full drive, in dBm
L_{Ref}	=	reference level, in dBm
a_{RF}	=	RF attenuation set via attenuator, in dB

A compromise between low signal-to-noise ratio and low distortion has to be found in the selection of the mixer level. To optimize the mixer level for specific applications, some analyzers allow the user to freely select the mixer level for a given reference level. Predefined coupling degrees are often provided:

- **Low signal-to-noise ratio**

The lower the RF attenuation, the lower the reduction of the signal-to-noise ratio before the first mixer. For low displayed noise, a high mixer level is required (see chapter 5.1: Inherent noise).

- **Low distortion**

The lower the mixer level, the lower the distortion produced in a spectrum analyzer due to nonlinearities. In this display mode, the RF attenuation is higher (see chapter 5.2: Nonlinearities).

Table 4-2 shows some typical settings of RF attenuation and IF gain at a given reference level for the different display modes. The example shows that even at very low reference levels, an RF attenuation of at least 10 dB is always set. In this way the first mixer is protected and a good input match is realized. Thus a higher level accuracy for absolute level measurements is achieved (see chapter 5.10.1: Error components). In this example, the RF attenuation can be set to a maximum of 70 dB, and the IF gain to a maximum of 50 dB.

Mixer level	-40 dBm (low distortion)		-30 dBm (normal)		-20 dBm (low noise)	
Reference level	RF atten- uation	IF gain	RF atten- uation	IF gain	RF atten- uation	IF gain
+30 dBm	70 dB	30 dB	60 dB	20 dB	50 dB	10 dB
+20 dBm	60 dB	30 dB	50 dB	20 dB	40 dB	10 dB
+10 dBm	50 dB	30 dB	40 dB	20 dB	30 dB	10 dB
0 dBm	40 dB	30 dB	30 dB	20 dB	20 dB	10 dB
-10 dBm	30 dB	30 dB	20 dB	20 dB	10 dB	10 dB
-20 dBm	20 dB	30 dB	10 dB	20 dB	10 dB	20 dB
-30 dBm	10 dB	30 dB	10 dB	30 dB	10 dB	30 dB
-40 dBm	10 dB	40 dB	10 dB	40 dB	10 dB	40 dB
-50 dBm	10 dB	50 dB	10 dB	50 dB	10 dB	50 dB
-60 dBm	10 dB	50 dB	10 dB	50 dB	10 dB	50 dB
-70 dBm	10 dB	50 dB	10 dB	50 dB	10 dB	50 dB
-80 dBm	10 dB	50 dB	10 dB	50 dB	10 dB	50 dB
-90 dBm	10 dB	50 dB	10 dB	50 dB	10 dB	50 dB
-100 dBm	10 dB	50 dB	10 dB	50 dB	10 dB	50 dB

*Table 4-2 Example of setting RF attenuation and IF gain at a given reference level
(IF gain max. 50 dB, RF attenuation max. 70 dB)*

4.6.3 Overdriving

When using a spectrum analyzer care should be taken to avoid overdriving by input signals with levels too high. Overdriving may occur at several points in the signal path. To avoid this, both the RF attenuation and the reference level (IF gain) have to be set correctly. In the following, the critical components and the criteria to be observed are described.

First mixer

To cover the lower frequency range (up to 3 GHz in the case of the analyzer described here), the principle of a high first intermediate frequency is usually employed in the RF input sections. If the spectrum analyzer does not feature a narrowband preselector ahead of the first mixer, signals may be taken to the first mixer in the total input frequency range (up to 3 GHz in our example) irrespective of the span to be displayed. The mixer may thus also be overdriven by signals lying far outside the displayed span. The distortion products produced in this way (harmonics of higher order) may impair the displayed spectrum depending on the span chosen for display (Fig. 4-33 and Fig. 4-34).

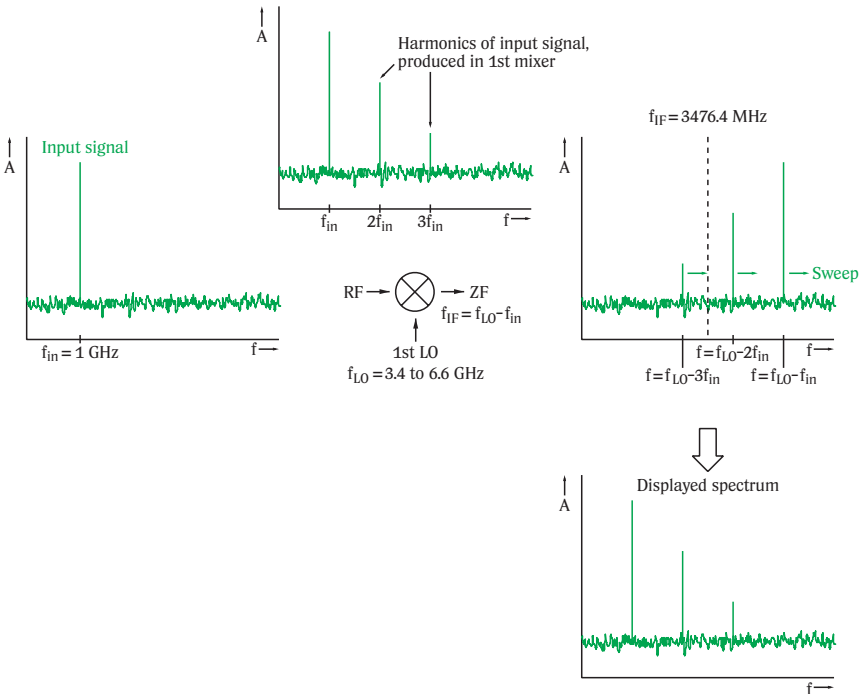
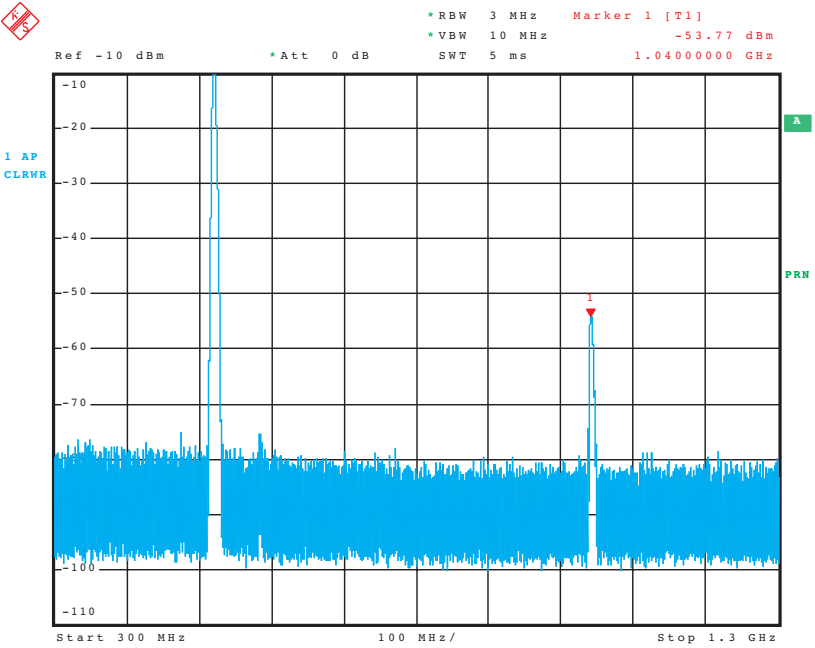
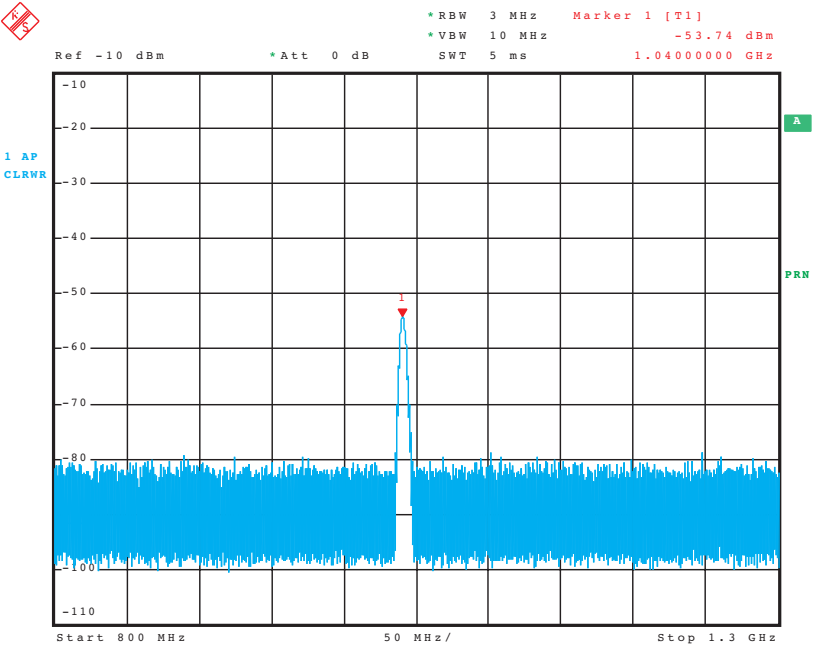

Fig. 4-33 Higher-order harmonics of input signals which are produced in first mixer



a)



b)

Fig. 4-34 Spectrum analyzer driven by a sinusoidal signal with $f = 520$ MHz (a). The second harmonic with $f = 1040$ MHz that is produced in the first mixer appears even if the fundamental of the signal is not contained in the displayed spectrum (b)

To avoid overdriving, the mixer level (the total signal level at the input of the first mixer) should be below the mixer's 1 dB compression point. The latter is specified in the data sheet of the respective spectrum analyzer (see chapter 5.4). As described in chapter 4.6.2, the mixer level is set with the aid of the attenuator. Some contemporary spectrum analyzers feature an overload detector ahead of the first mixer, so that an overdrive warning can be displayed.

If the input section of the spectrum analyzer features a narrowband tracking preselector, the risk of the analyzer being overdriven by signals outside the displayed spectrum is considerably reduced. The analyzer described in this chapter contains a narrowband preselector in form of a tracking YIG filter in the signal path for the frequency range from 3 GHz to 7 GHz. If a small span of this frequency range is displayed, the first mixer can only be overdriven by signals within or close to the displayed spectrum. Due to the limited skirt selectivity of the YIG filter, input signals outside the displayed spectrum must have a certain spacing from the range of interest so that they will be sufficiently suppressed by the filter and not overdrive the mixer (Fig. 4-35).

To allow EMC measurements, which often imply a very large number of simultaneously occurring spectral components at a high level, with the spectrum analyzer in line with relevant standards, analyzers can usually also be enhanced with optional narrowband tracking preselectors in the lower input frequency range.

IF signal processing through to resolution filter

The first mixer is followed by analog signal processing stages such as IF amplifiers and conversion stages. These stages can only be overdriven by strong signals within or in the vicinity of the displayed spectrum. Signals outside the displayed spectrum are suppressed after the first conversion by the subsequent IF filters, provided the frequency spacing from the range of interest is sufficiently large (Fig. 4-36). The IF filter in the 1st and 2nd IF stage is usually extremely wideband so the required frequency spacing for adequate attenuation may be very large (often some 100 MHz).

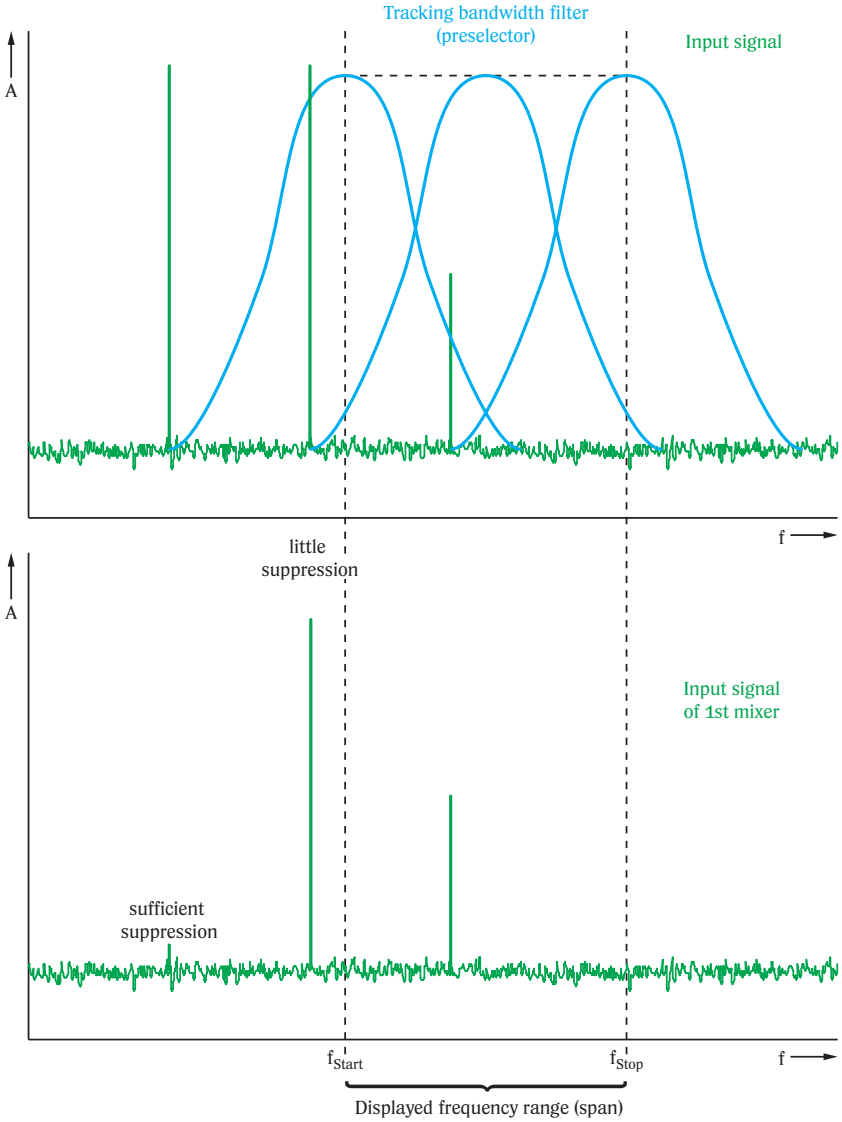

Fig. 4-35 Suppression of input signals outside the displayed spectrum by a tracking YIG filter

Unlike overdriving of the first mixer, distortion products caused by overdriving of analog IF signal processing components do not appear in the displayed spectrum. They are suppressed by the subsequent narrowband resolution filters (Fig. 4-37).

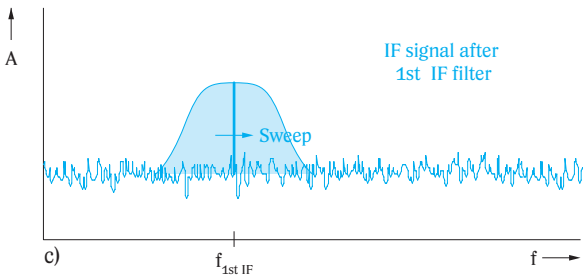
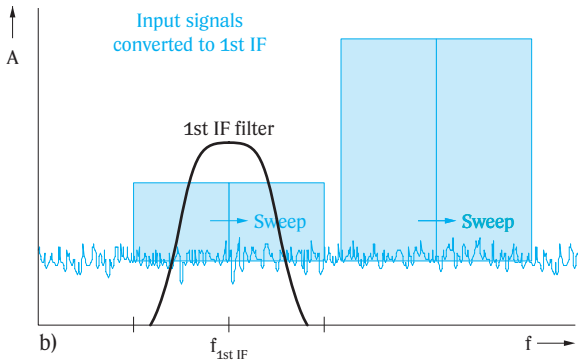
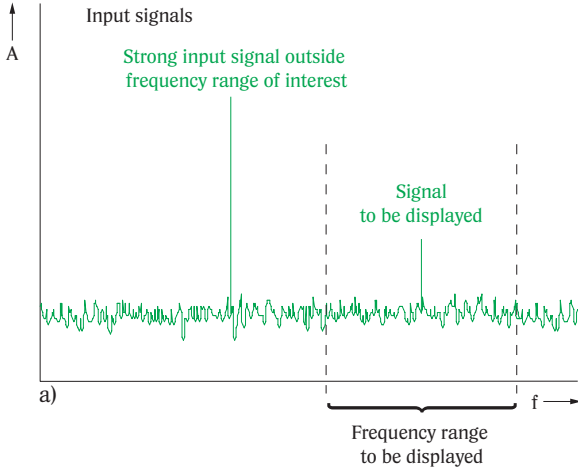
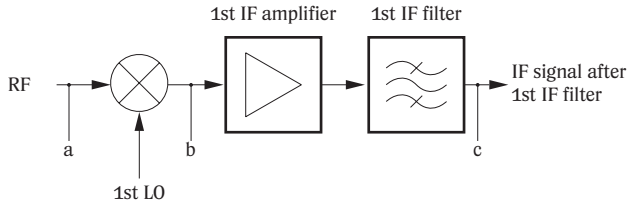

Fig. 4-36 Suppression of mixture products at the 1st IF by the first IF filter

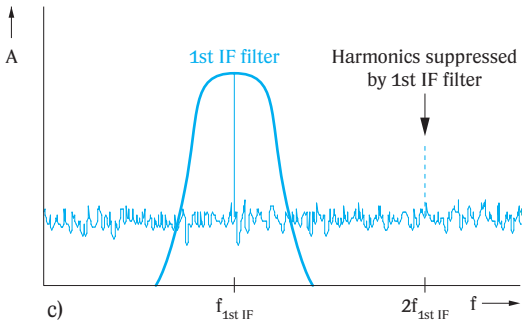
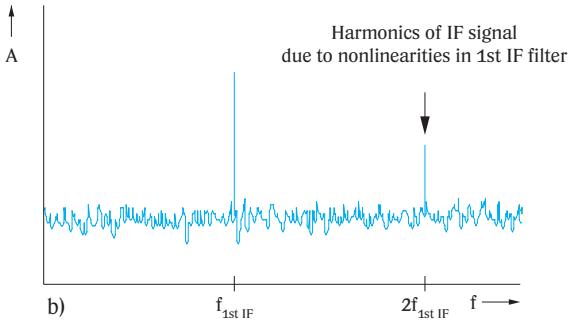
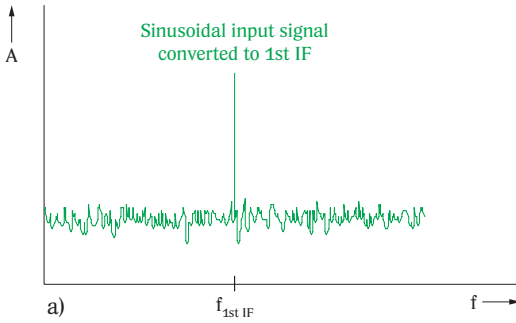
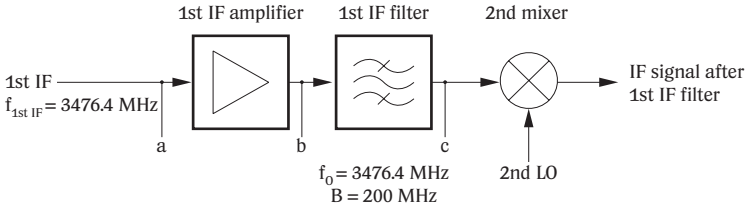

Fig. 4-37 Suppression of distortion products produced in analog IF signal processing components

The spectrum analyzer described here has overload detectors at the 2nd and 3rd IF so that overdriving of the analog IF processing stages can be indicated (44 and 45).

Settable IF amplifier and subsequent stages

If a signal exceeds the reference level in the displayed spectrum, the settable IF amplifier and subsequent signal processing stages will be overdriven. Their response depends on the selected settings. Based on the block diagram of the spectrum analyzer shown on the fold-out page, the following cases are possible:

- **Use of analog IF filters**

Exceeding the reference level causes overdriving of the log amplifier (with logarithmic level display) or overdriving of the envelope detector (with linear level display).

It is not possible to perform measurements on an input signal whose level exceeds the reference level. Level measurements on weak signals in the immediate vicinity are, however, not affected by overdriving (Fig. 4-38). As shown in the block diagram, the resolution filter is made up of several individual circuits. The filter circuits ahead of the settable IF amplifier provide for suppression of strong input signals outside the pass-band. Therefore, there will be no distortion products that might impair the displayed spectrum.

- **Use of digital IF filters or FFT filters**

When using digital IF filters or FFT filters, the IF signal is sampled with the aid of an A/D converter. If in the displayed spectrum a signal level exceeds the reference level, the A/D converter may be overdriven. Unlike analog filters, mixture products are produced which become visible in the displayed spectrum (Fig. 4-39).

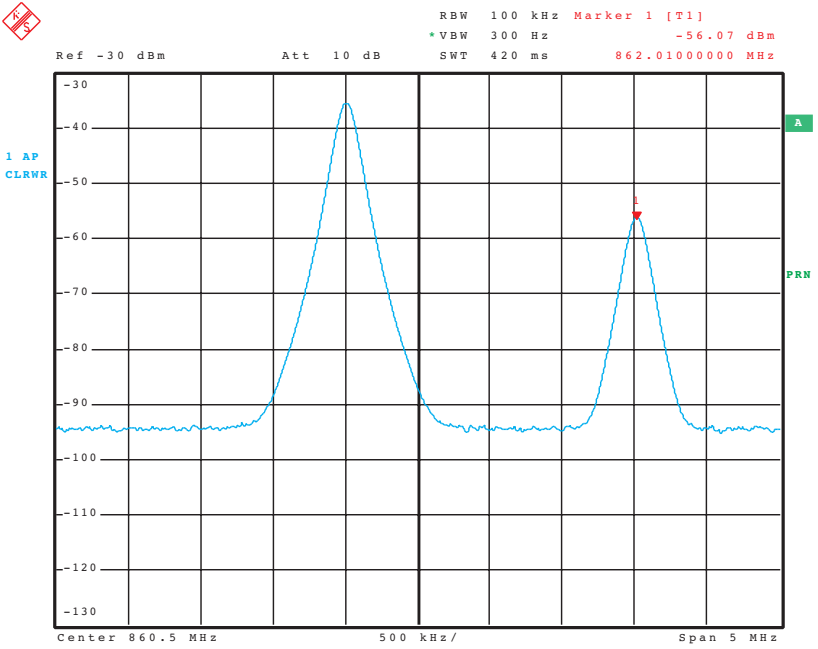

a)

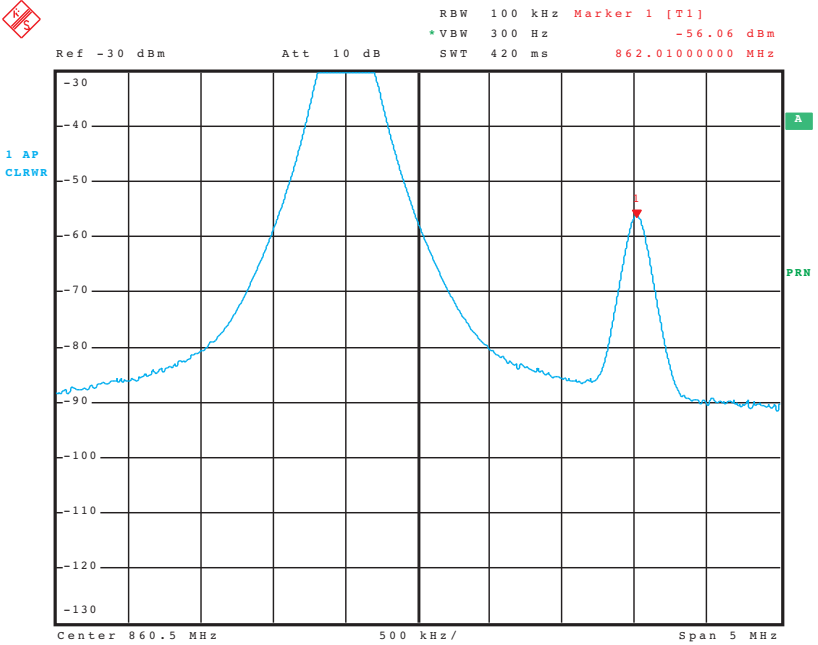

b)

Fig. 4-38 Level measurement on a weak input signal signal in the presence of a very strong signal, with normal driving (a) and overdriving of the settable IF amplifier (b). Overdriving has no effect on the measurement result

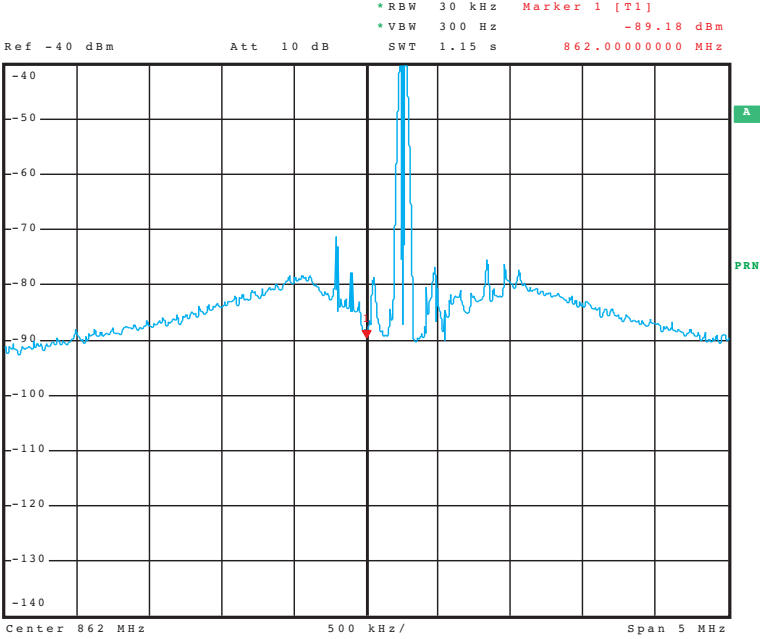

a)

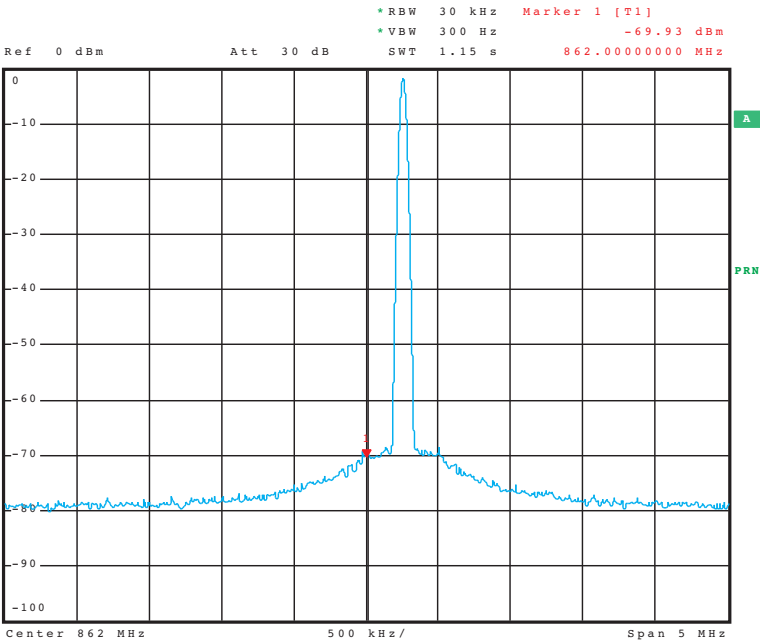

b)

Fig. 4-39 Mixture products due to overdriving of A/D converter
 converter when using digital IF filters or FFT filters (a);
 displayed spectrum in case of correct driving (b)

5 PERFORMANCE FEATURES OF SPECTRUM ANALYZERS

5.1 Inherent noise

Inherent noise is understood as the thermal noise which characterizes both receivers and spectrum analyzers. Due to inherent noise the signal-to-noise ratio of an input signal is reduced. Therefore, inherent noise is a measure of the sensitivity of the spectrum analyzer. It allows conclusions to be drawn as to the minimum level required for the input signal to be detectable.

The inherent noise of receivers can be specified in different ways, usually it is expressed as the noise factor or noise figure.

The non-dimensional noise factor F of a two-port network is the ratio between the signal-to-noise ratio at the input of the network and the signal-to-noise ratio at the output of the network. The following applies:

$$F = \frac{S_1/N_1}{S_2/N_2} \tag{Equation 5-1}$$

where S_1/N_1 = signal-to-noise ratio at the input of the network

S_2/N_2 = signal-to-noise ratio at the output of the network

The noise figure NF is then given by

$$NF = 10 \cdot \log F \tag{Equation 5-2}$$

It is stated in dB.

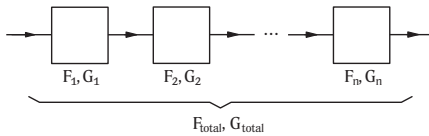

Fig. 5-1 Several cascaded noisy networks

The total noise factor F_{total} of cascaded networks is given by

$$F_{total} = F_1 + \frac{F_2 - 1}{G_1} + \frac{F_3 - 1}{G_1 \cdot G_2} + \dots + \frac{F_n - 1}{\prod_{i=1}^{n-1} G_i} \quad (\text{Equation 5-3})$$

where F_i = noise factor of an individual stage
 G_i = gain of an individual stage

The following holds true for passive lossy networks such as cables or attenuator pads:

$$F = 10^{\frac{a}{10}} \text{ and } NF = a \quad (\text{Equation 5-4})$$

where F and NF = noise factor and noise figure of network
 a = attenuation of network, in dB

Equation 5-3 reveals that the noise factor of the first stage is fully taken into account in the total noise factor of a cascaded circuit. The attenuator is located at the input of a spectrum analyzer - a passive stage whose noise factor can be calculated by means of Equation 5-4.

The total noise factor of the analyzer therefore depends on the attenuator setting. Increasing the attenuation by 10 dB, for instance, results in a 10 dB higher total noise figure. Maximum sensitivity is therefore attained with an attenuator setting of 0 dB (see Fig. 5-2).

The sensitivity of spectrum analyzers is usually specified as the displayed average noise level (DANL), a parameter that can be directly read from the display of the spectrum analyzer.

The noise produced in a receiver is thermal noise, which means that it does not contain any discrete components. The probability of a noise voltage occurring in a specific voltage range can be derived from the Gaussian distribution so that the designation Gaussian noise is also used.

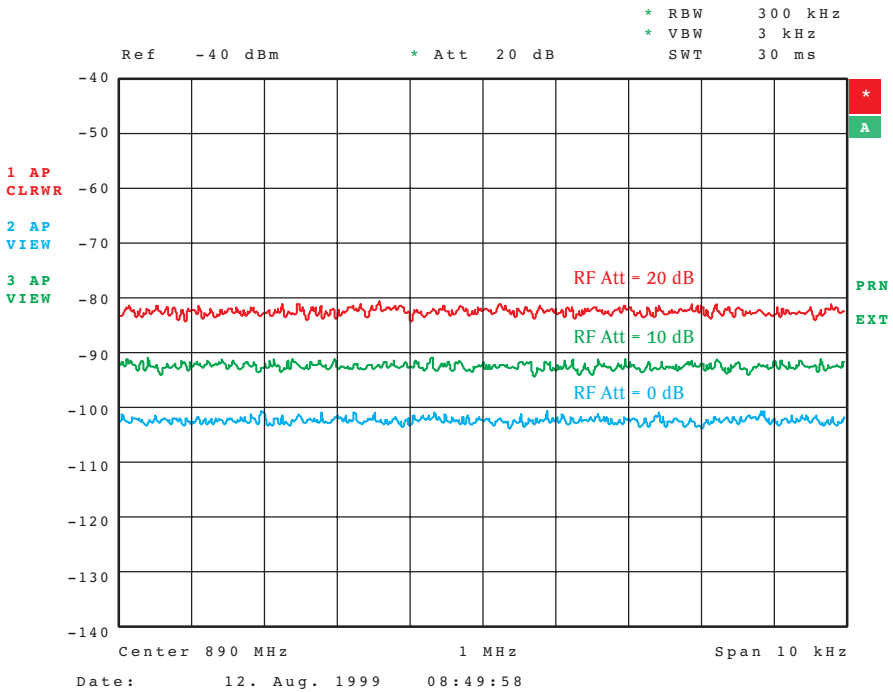

Fig. 5-2 Displayed average noise level of spectrum analyzer as a function of RF attenuation

The displayed noise corresponds to the noise voltage picked up at the envelope detector. The corresponding noise power can be calculated by integration of the noise density over the noise bandwidth of the receiver which would be the noise bandwidth of all stages ahead of the detector. In the case of spectrum analyzers, this bandwidth is determined by the noise bandwidth of the IF filter. Accordingly, the displayed noise depends on the resolution bandwidth setting.

Since the spectral power density of thermal noise is constant within the noise bandwidth, the displayed average noise level can be calculated as follows provided the noise figure of the analyzer and the noise bandwidth of the selected IF filter are known:

$$L_{DAN} = 10 \cdot \log \left(\frac{k \cdot T \cdot B_{N,IF}}{1 \cdot 10^{-3} \text{ W}} \right) + NF_{SA} - 2.5 \text{ dB} \quad (\text{Equation 5-5})$$

- where
- L_{DAN} = displayed average noise level, in dBm
 - k = Boltzmann's constant, $k = 1.38 \cdot 10^{-23}$ W/Hz
 - T = ambient temperature, in K
 - $B_{N,IF}$ = noise bandwidth of IF filter
 - NF_{SA} = noise figure of spectrum analyzer, in dB
 - 2.5 dB = underweighting of noise by sample detector and averaging of logarithmic level values

For an ambient temperature of 290 K, the displayed average noise level is given by:

$$L_{DAN} = -174 \text{ dBm (1 Hz)} + \left(10 \cdot \log \frac{B_{N,IF}}{\text{Hz}} \right) \text{ dB} + NF_{SA} - 2.5 \text{ dB} \quad (\text{Equation 5-6})$$

The value of -174 dBm (1 Hz) corresponds to the available thermal noise power across an ohmic resistance in 1 Hz bandwidth at an ambient temperature of 290 K. This is the noise floor, or the absolute minimum noise level at a given temperature.

The sample detector usually used for noise measurements with spectrum analyzers (chapter 4.4: Detectors) determines the arithmetic mean of the noise. In the case of Gaussian noise this is 1.05 dB below the RMS value (the effective noise power). Due to averaging of the results on a logarithmic scale by averaging over several traces, the displayed noise is reduced by a further 1.45 dB. In calculating the displayed average noise level according to Equation 5-6, this is taken account of by the subtraction of 2.5 dB. This correction is only permissible for Gaussian noise, which can be assumed for thermal noise.

The following relationship can be derived from Equation 5-5 for the variation of the displayed noise as a function of varying the IF bandwidth setting of $B_{IF,1}$ to $B_{IF,2}$:

$$\Delta L_{DAN} = 10 \cdot \log \frac{B_{N,IF,2}}{B_{N,IF,1}} \quad (\text{Equation 5-7})$$

where $B_{N,IF,1}$, $B_{N,IF,2}$ = noise bandwidth of IF filter before and after variation of setting, in Hz
 ΔL_{DAN} = variation of displayed noise as a function of varying the IF bandwidth, in dB

If both IF filters have the same relationship between 3 dB bandwidth and noise bandwidth, the difference in the displayed noise can also be calculated from the 3 dB bandwidths. The following then applies:

$$\Delta L_{DAN} = 10 \cdot \log \frac{B_{IF,2}}{B_{IF,1}} \quad (\text{Equation 5-8})$$

where $B_{IF,1}$, $B_{IF,2}$ = 3 dB bandwidth of IF filter before and after variation of setting, in Hz

Fig. 5-3 shows the effects of different IF bandwidths on the displayed noise. Due to the different practical realization of the IF filters of a spectrum analyzer, the noise figure of the analyzer may also depend on the selected resolution bandwidth. The actual variation of the displayed average noise level may therefore differ from the value worked out with Equation 4-8.

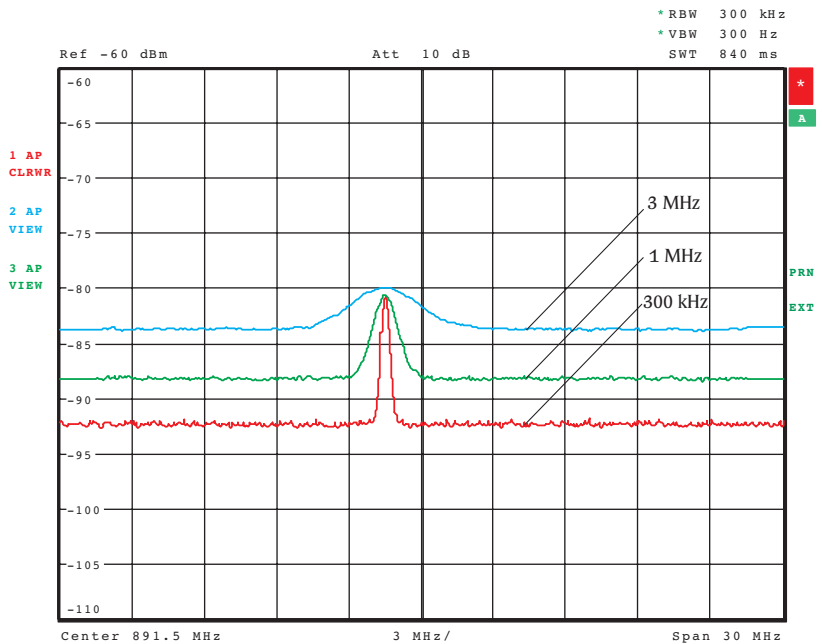

Fig. 5-3 Displayed average noise level at various resolution bandwidths

The sensitivity limit of the analyzer can also be determined from the displayed average noise level. This is understood as the minimum level of an input signal required to yield a noise increase of 3 dB in the display of the analyzer, and is called the minimum detectable signal. Since on the spectrum analyzer the sum of input signal and noise ($S + N$) is displayed, this condition is fulfilled with an input level that corresponds to the effective noise level of the inherent thermal noise ($S = N$). In this case the signal-to-noise ratio is given by

$$\frac{S + N}{N} = 2 \quad \text{and} \quad 10 \cdot \log \left(\frac{S + N}{N} \right) = 3 \text{ dB.} \quad (\text{Equation 5-9})$$

N corresponds to the displayed noise level when using an RMS detector.

Displayed average noise level	
(0 dB RF attenuation, RBW 10 Hz, VBW 1 Hz, 20 averages, trace average, span 0 Hz, termination 50 Ω)	
Frequency	
9 kHz	<-95 dBm
100 kHz	<-100 dBm
1 MHz	<-120 dBm, typ. -125 dBm
10 MHz to 7 GHz	<-138 dBm, typ. -143 dBm

Fig. 5-4 Typical specifications for displayed noise of a spectrum analyzer (extract from data sheet)

Data sheet specifications for the displayed average noise level must always include the resolution bandwidth and attenuator setting. Typical settings are 0 dB RF attenuation and the smallest resolution bandwidth available.

For a stabilized noise display, appropriate averaging is required which can be achieved with a narrow video bandwidth (1 Hz in the above data sheet extract) and averaging over several traces (trace average). In our example 20 traces are averaged.

Maximum sensitivity

The maximum sensitivity of spectrum analyzers is obtained with an attenuator setting of 0 dB. It is important that the first mixer of the analyzer is not overdriven by a high-level signal - even outside the displayed frequency range.

To further reduce the displayed noise, the resolution bandwidth is reduced. A trade-off has to be found between low displayed noise and high measurement speed. For the display of input signals with a very low signal-to-noise ratio, it is useful to reduce the video bandwidth as well as the resolution bandwidth or to increase the sweep time when using the RMS detector. The trace is thus smoothed so that the input signal is clearly displayed. The measured levels are thus stabilized - a prerequisite for accurate, reproducible results.

If the sensitivity of the spectrum analyzer is unsatisfactory, it can be enhanced with aid of an external preamplifier. The total noise factor of the preamplifier and spectrum analyzer arrangement can be calculated from Equation 5-3. F_1 and G_1 correspond to the noise factor and gain of the preamplifier, F_2 to the noise factor of the spectrum analyzer.

For level measurements it is essential to know the frequency-dependent gain of the preamplifier. This gain must be subtracted from the measured levels. Many spectrum analyzers offer the possibility of taking into account the frequency-dependent gain with the aid of transducer tables. Recorded spectra can thus automatically be displayed with the correct levels.

High sensitivity of the spectrum analyzer is especially important for applications in which the resolution bandwidth is prescribed by standards. In these cases a reduction of the displayed noise by decreasing the resolution bandwidth is not permitted. The sensitivity is also important for fast measurement speeds. To attain sufficiently low displayed noise, narrowband IF filters are required with lower sensitivities, which in turn increases the sweep time. Spectrum analyzers featuring a low noise figure allow the use of greater resolution bandwidths and hence shorter sweep times (chapter 4.6: Parameter dependencies).

5.2 Nonlinearities

An ideal linear two-port network provides for distortion-free transfer of signals from its input to its output. The voltage transfer function of such a network is

$$v_{out}(t) = G_V \cdot v_{in}(t) \quad \text{(Equation 5-10)}$$

where $v_{out}(t)$ = voltage at output of network
 $v_{in}(t)$ = voltage at input of network
 G_V = voltage gain of network

Such ideal networks can only be realized with the aid of passive components. Resistive attenuator pads, for instance, can be assumed to be ideal.

Networks containing semiconductor components, for instance amplifiers or mixers, exhibit nonlinearities. In this case the transfer function can be approximated by a power series as follows:

$$v_{out}(t) = \sum_{n=1}^{\infty} a_n \cdot v_{in}^n(t) = a_1 \cdot v_{in}(t) + a_2 \cdot v_{in}^2(t) + a_3 \cdot v_{in}^3(t) + \dots \quad \text{(Equation 5-11)}$$

where $v_{out}(t)$ = voltage at output of network
 $v_{in}(t)$ = voltage at input of network
 a_n = coefficient of nonlinear element of voltage gain

In most cases it is sufficient to consider the square and cubic terms so that the power series according to Equation 5-11 is taken up to $n = 3$.

For many components, such as mixers or level detectors, the nonlinear response is desirable. Spectrum analyzers, however, should feature distortion-free display of the input signals. Accordingly, linearity is an essential criterion for the assessment of a spectrum analyzer.

The effects of a network's nonlinearities on its output spectrum depend on its input signal.

Single-tone input

If an input to a network is a sinusoidal signal $v_{in}(t)$ of

$$v_{in}(t) = \hat{U}_{in} \cdot \sin(2\pi f_{in,1} \cdot t) \tag{Equation 5-12}$$

where \hat{U}_e = peak value of $v_{in}(t)$
 $f_{in,1}$ = frequency of $v_{in}(t)$,

is present, this is referred to as a single-tone input. By substituting Equation 5-12 in Equation 5-11 it can be seen that due to nonlinearities, harmonics of the input signal are produced with the frequencies $f_{n,H} = n \cdot f_1$ (see Fig. 5-5).

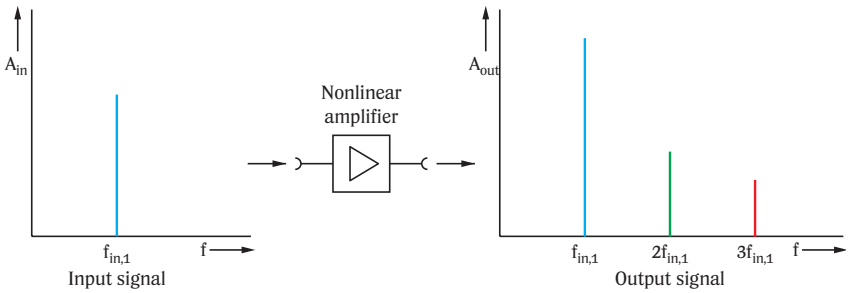

Fig. 5-5 Spectrum before and after nonlinear network

The levels of these harmonics depend on the coefficients a_n in Equation 5-11. They are also dependent on the order n of the respective harmonic as well as on the input level. When the input level is increased, the levels of harmonics increase with their order. That is, a variation of the input level by Δ dB causes a variation of the harmonic level by $n \cdot \Delta$ dB.

Data sheet specifications on this type of signal distortion usually refer to the second harmonic only for which the level difference a_{k2} from the fundamental at the output of the network is specified. The specifications are valid for a certain input level L_{in} , which has always to be stated. When comparing spectrum analyzers, it should therefore always be checked whether the specifications of the various models refer to the same mixer level.

Level-independent specifications that can be made with the aid of the intercept point (known as the second harmonic intercept SHI) are much more convenient for comparisons. The second harmonic intercept corresponds to the assumed input or output level at which the second harmonic of the input signal at the output of the network attains the same level as the fundamental (Fig. 5-6).

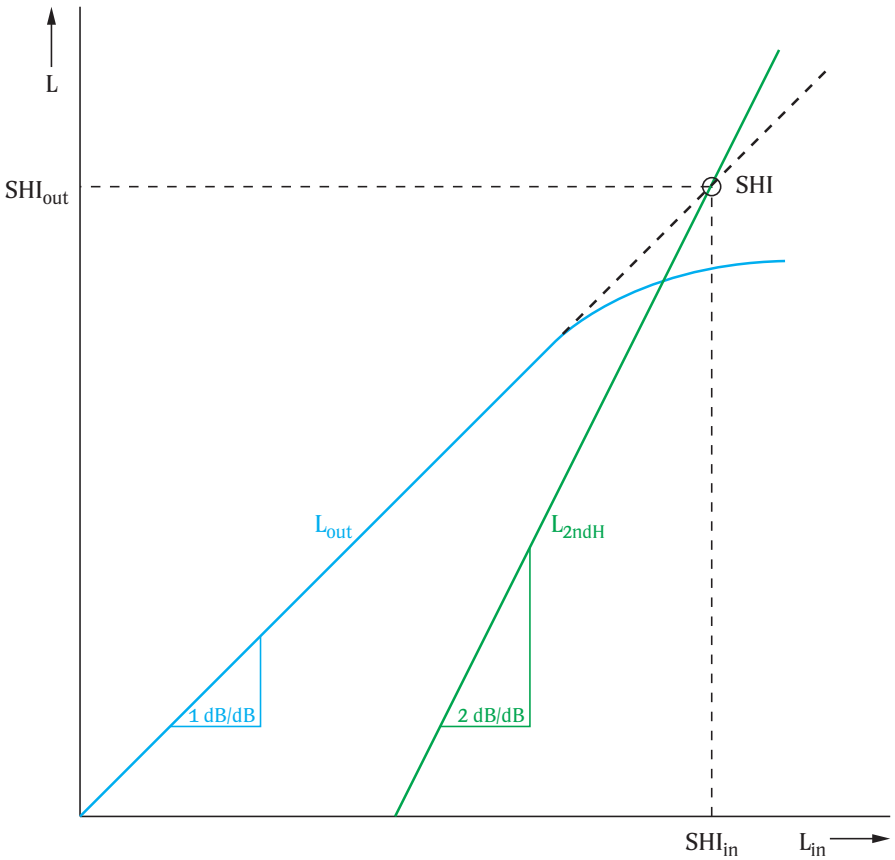

Fig. 5-6 Second harmonic intercept

In practice, this point can never be attained since the network, as shown in Fig. 5-6, already provides compression at lower input levels. The intercept point can be referred either to the network's input level or output level and is therefore designated as input or output intercept point (SHI_{in} and SHI_{out}).

Since the output intercept point depends on the gain of the network, the input intercept point (with selected RF attenuation, usually 0 dB) is always stated in the spectrum analyzer specifications.

With given input level L_{in} and harmonic level difference a_{k2} of the second harmonic, input intercept point can be calculated as follows:

$$SHI_{in} = a_{k2} + L_{in} \tag{Equation 5-13}$$

SHI_{out} referred to the output is calculated as

$$SHI_{out} = SHI_{in} + g \tag{Equation 5-14}$$

where g = power gain of network, in dB

Two-tone input

With a two-tone input, signal $v_{in}(t)$ consisting of two sinusoidal signals of equal amplitude is applied to the input of the network. The input signal is given by:

$$v_{in}(t) = \hat{U}_{in} \cdot \sin(2\pi f_{in,1} \cdot t) + \hat{U}_{in} \cdot \sin(2\pi f_{in,2} \cdot t) \tag{Equation 5-15}$$

where \hat{U}_{in} = peak value of the two sinusoidal signals
 $f_{in,1}, f_{in,2}$ = signal frequencies

By substituting Equation 5-15 in the nonlinear transfer function according to Equation 5-11, the mixture products listed in Table 5-1 are obtained among others at the output of the network. The angular frequency ω is always stated as $\omega_1 = 2 \cdot \pi \cdot f_{in,1}$ and $\omega_2 = 2 \cdot \pi \cdot f_{in,2}$.

DC component	$a_2 \cdot 0.5(\hat{U}_{in,1}^2 + \hat{U}_{in,2}^2)$
Fundamentals	$a_1 \cdot \hat{U}_{in,1} \cdot \sin(\omega_1 t)$ $a_1 \cdot \hat{U}_{in,2} \cdot \sin(\omega_2 t)$
2nd harmonics	$a_2 \cdot 0.5 \cdot \hat{U}_{in,1}^2 \cdot \cos(2 \cdot \omega_1 t)$ $a_2 \cdot 0.5 \cdot \hat{U}_{in,2}^2 \cdot \cos(2 \cdot \omega_2 t)$
Intermodulation products of 2nd order	$a_2 \cdot \hat{U}_{e,1} \cdot \hat{U}_{in,2} \cdot \cos(\omega_1 - \omega_2)t$ $a_2 \cdot \hat{U}_{e,1} \cdot \hat{U}_{in,2} \cdot \cos(\omega_1 + \omega_2)t$
3rd harmonics	$a_3 \cdot 0.25 \cdot \hat{U}_{in,1}^3 \cdot \sin(3 \cdot \omega_1 t)$ $a_3 \cdot 0.25 \cdot \hat{U}_{in,2}^3 \cdot \cos(3 \cdot \omega_2 t)$
Intermodulation products of 3rd order	$a_3 \cdot \hat{U}_{in,1}^2 \cdot \hat{U}_{in,2} \cdot 0.75 \cdot \sin(2\omega_1 + \omega_2)t$ $a_3 \cdot \hat{U}_{in,1}^2 \cdot \hat{U}_{in,2} \cdot 0.75 \cdot \sin(2\omega_2 + \omega_1)t$ $a_3 \cdot \hat{U}_{in,1} \cdot \hat{U}_{in,2}^2 \cdot 0.75 \cdot \sin(2\omega_1 - \omega_2)t$ $a_3 \cdot \hat{U}_{in,1} \cdot \hat{U}_{in,2}^2 \cdot 0.75 \cdot \sin(2\omega_2 - \omega_1)t$

Table 5-1 Mixture products with two-tone input

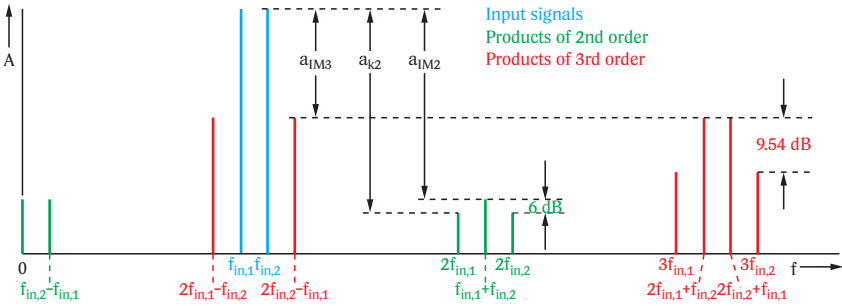

Fig. 5-7 Output spectrum of nonlinear network with two-tone input (magnitude spectrum)

In addition to the harmonics, intermodulation products are produced, also referred to as difference-frequency distortion. The order of intermodulation products corresponds to the sum of the ordinal numbers of the components involved. For the product at $2 \cdot f_{in,1} + 1 \cdot f_{in,2}$, for instance, the order is $2 + 1 = 3$. Table 5-1 gives products up to the 3rd order.

While even-numbered intermodulation products always occur far from the two input signals in frequency, odd-numbered intermodulation products of low order are always found in the close vicinity of the input signal.

Depending on the application, products of both even-numbered and odd-numbered order may cause interference. For measurements on CATV systems, where a frequency range covering more than one octave is to be examined, harmonics as well as intermodulation products of even-numbered order fall within the range of interest. For this application the requirements placed on the SHI of the spectrum analyzer are therefore very stringent, particularly as in such systems usually a large number of signals with very high level occurs.

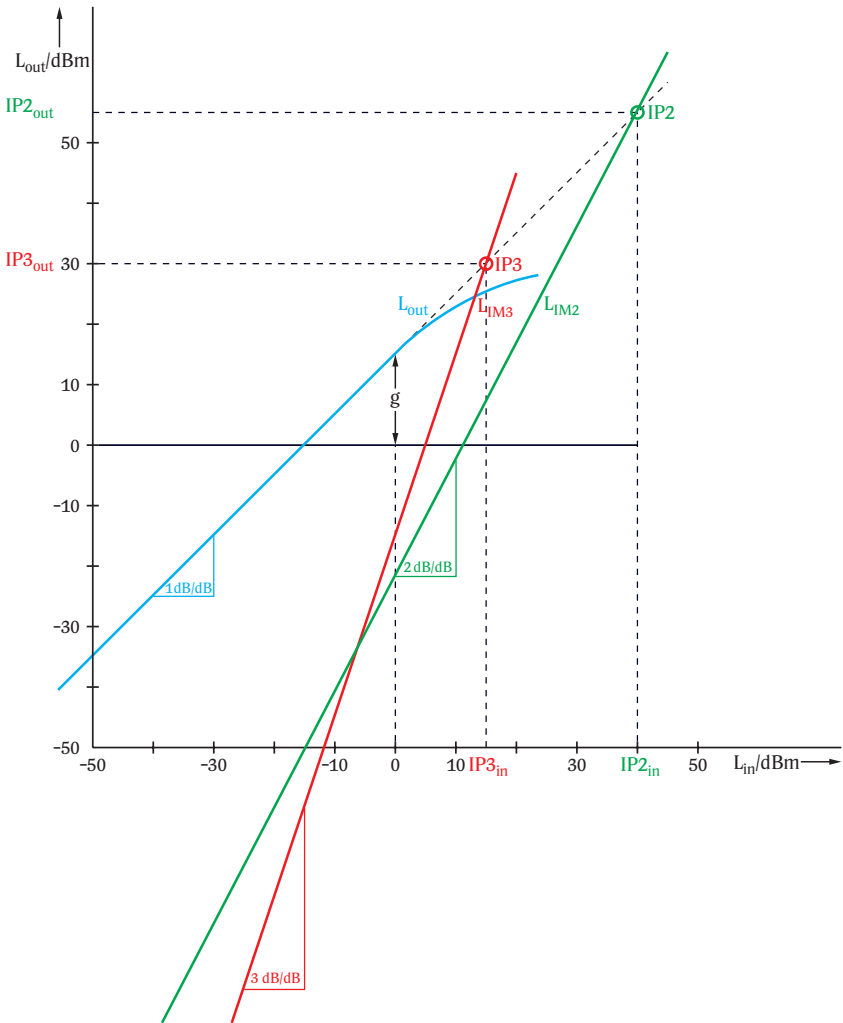

Fig. 5-8 Intercept point of 2nd and 3rd order

For harmonics of higher order, a level variation of the two sinusoidal carriers at the input by Δ dB causes a level variation of the respective intermodulation product by $n \cdot \Delta$ dB. The level differences between intermodulation products and the fundamentals of the sinusoidal carriers must therefore always be specified together with the input level since otherwise no conclusion can be drawn as to the linearity. It is therefore advantageous to calculate the intercept point of n th order too. The intercept point of n th order referred to the input is given by:

$$IPn_{in} = \frac{a_{IMn}}{n - 1} + L_{in} \tag{Equation 5-16}$$

- where IPn_{in} = input intercept point of n th order, in dBm
- a_{IMn} = level difference between intermodulation product of n th order and fundamental of the input signal, in dB
- L_{in} = level of one of the two input signals, in dBm

In most cases, the intercept points of 2nd and 3rd order are specified (Fig. 5-8). They are designated as IP2 or SOI (second order intercept) and IP3 or TOI (third order intercept). The input intercept points of 2nd and 3rd order are given by

$$IP2_{in} = a_{IM2} + L_{in} \tag{Equation 5-17}$$

and

$$IP3_{in} = \frac{a_{IM3}}{2} + L_{in} \tag{Equation 5-18}$$

The output intercept points can be calculated from the input intercept points by adding the gain g of the network (in dB). In spectrum analyzer specifications the intercept points are referred to the input.

The 2nd order intermodulation products with two-tone input as well as the 2nd harmonics with single-tone input are produced due to the square term of the nonlinear transfer function. There is a fixed relationship between IP2 and SHI (see [5-1]):

$$SHI = IP2 + 6 \text{ dB} \tag{Equation 5-19}$$

Therefore only IP2 or SHI is usually specified in data sheets, but rarely both values are specified. Intercept points are usually stated in dBm. The higher the specified intercept point, the more linear the spectrum analyzer, which is an essential prerequisite for a large dynamic range (chapter 5.5: Dynamic range).

Intermodulation	
3rd order intermodulation	
Intermodulation-free dynamic range level 2×-30 dBm, $\Delta f > 5 \cdot \text{RBW}$ or 10 kHz, whichever is the greater value	
Frequency	
20 MHz to 200 MHz	>70 dBc, TOI >5 dBm
200 MHz to 3 GHz	>74 dBc, TOI >7 dBm
3 GHz to 7 GHz	>80 dBc, TOI >10 dBm
2nd harmonic intercept point (SHI)	
Frequency <50 MHz	25 dBm
50 MHz to 3 GHz	35 dBm
3 GHz to 7 GHz	45 dBm

Fig. 5-9 Typical specifications for intermodulation characteristics of a spectrum analyzer (extract from data sheet)

Intercept points specified in data sheets are only valid for a specific attenuator setting, usually 0 dB. As will be explained later, the intercept point increases with increasing RF attenuation.

Examples: Comparison of data sheet specifications of two spectrum analyzers

1.) Analyzer 1:

Calculate IP_{3in} and IP_{2in} of a spectrum analyzer with a two-tone input of -30 dBm each. The 3rd order intermodulation products are at least 70 dB below the input signal

Analyzer 2:

Calculate IP_{3in} and IP_{2in} of a spectrum analyzer with a two-tone input of -40 dBm each. The 3rd order intermodulation products are at least 100 dB below the input signal

Solution

Analyzer 1: $IP3_{in} = \frac{70 \text{ dB}}{2} + (-30 \text{ dBm}) = +5 \text{ dBm}$

Analyzer 2: $IP3_{in} = \frac{100 \text{ dB}}{2} + (-40 \text{ dBm}) = +10 \text{ dBm}$

2.) Analyzer 1

With two-tone input of -30 dBm each the 2nd order intermodulation products are at least 65 dB below the input signal.

Analyzer 2

An SHI of +35 dBm is specified in the data sheet.

Solution

Analyzer 1: $IP2_{in} = 65 \text{ dB} + (-30 \text{ dBm}) = +35 \text{ dBm}$

Analyzer 2: $IP2_{in} = IPk2 - 6 \text{ dB} = 35 \text{ dBm} - 6 \text{ dB} = +29 \text{ dBm}$

Often the intermodulation-free dynamic range is specified in the data sheets. This is understood as the level difference between IM products and input signals. Unless otherwise stated, these data solely refer to 3rd order intermodulation products (products occurring in the vicinity of the input signals). An essential parameter is the signal level at the input of the first mixer which always has to be specified, too.

For the 3rd order intercept point specified in Fig. 5-9 (for the input frequency range 200 MHz to 3 GHz in our example), the intermodulation-free range can be calculated from $IP3_{in}$ by using Equation 5-18:

$$a_{IM3} = 2 \cdot (IP3_{in} - L_{in}) = 2 \cdot (7 \text{ dBm} - (-30 \text{ dBm})) = 74 \text{ dB} \quad (\text{Equation 5-20})$$

Attenuator pad or amplifier ahead of first mixer

If a preamplifier or attenuator pad is connected ahead of the first mixer of the spectrum analyzer, the total input intercept point of the arrangement is affected. The following applies to two cascaded stages [5-2]:

$$IP3_{in,total} = IP3_{in,1} + IP3_{in,2} - 10 \cdot \log \left(10^{\left(\frac{IP3_{in,1} + g_1}{10} \right)} + 10^{\left(\frac{IP3_{in,2}}{10} \right)} \right) \quad (\text{Equation 5-21})$$

- where $IP3_{in,total}$ = 3rd order input intercept point of cascaded stages, in dBm
 $IP3_{in,1}$, $IP3_{in,2}$ = 3rd order input intercept points of individual stages, in dBm
 g_1 = gain factor of first stage, in dB

Assuming an ideal linear attenuator pad - a prerequisite that is realistically implemented using resistive, mechanically switched attenuators - almost any value can be inserted into Equation 5-21 for $IP3_{in,1}$. An increase of the RF attenuation, for instance, from 0 dB to 10 dB ($g = -10$ dB in Equation 5-21) causes an increase of the intercept point by the same amount (10 dB in our case). At the same time, the noise figure of the analyzer is degraded to the same degree. Therefore, an increase of the RF attenuation does not increase the dynamic range (chapter 5.5: Dynamic range).

If a preamplifier is connected ahead of the analyzer, this will cause a degrading of the total intercept point.

Example:

An input intercept point of +7 dBm is specified for the spectrum analyzer. To increase the sensitivity, a preamplifier with a gain factor of 20 dB and an input intercept point of -10 dBm is to be connected. The total 3rd order input intercept point is then given by

$$IP3_{in,total} = -10 \text{ dBm} + 7 \text{ dBm} - 10 \cdot \log \left(10^{\left(\frac{-10 \text{ dBm} + 20 \text{ dB}}{10} \right)} + 10^{\left(\frac{7 \text{ dBm}}{10} \right)} \right) = -14.8 \text{ dBm}$$

Identification of intermodulation products

A typical application of the spectrum analyzer is distortion measurement on devices under test such as amplifiers or mixers. Distortion in the form of higher-order harmonics or intermodulation products is not only produced in the DUT but also in the spectrum analyzer. Especially with high signal levels at the input of the first mixer this may lead to incorrect measurements since the harmonics or intermodulation products generated in the spectrum analyzer are added to those produced in the DUT. Linearity measurement would indicate poorer characteristics than it is actually the case.

The spectrum analyzer's mixer and IF amplifier primarily determine the linearity of a spectrum analyzer, whereas the input RF attenuator has practically no effect. If the RF attenuator is used to vary the mixer level, the levels of intermodulation products generated in the spectrum analyzer are determined according to their order. The level of intermodulation products generated in the DUT remain constant.

With the aid of the RF attenuator, it can thus be determined where the intermodulation products displayed on the spectrum analyzer are generated. The measurement yields correct results if the relative levels of harmonics or intermodulation products remain constant despite an increase of the RF attenuation (Fig. 5-10a). If the relative level of the harmonics displayed on the spectrum analyzer varies however, the measurement result is incorrect.

(continued overleaf)

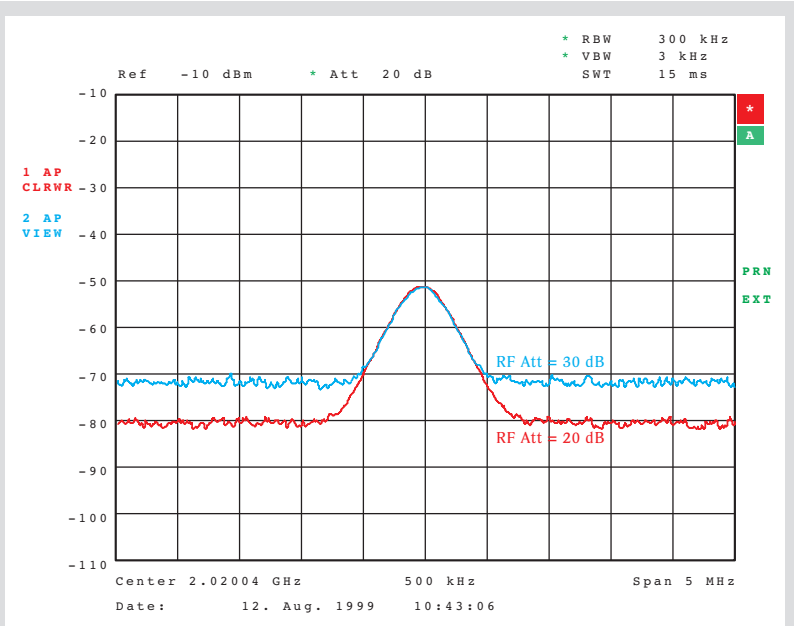

a)

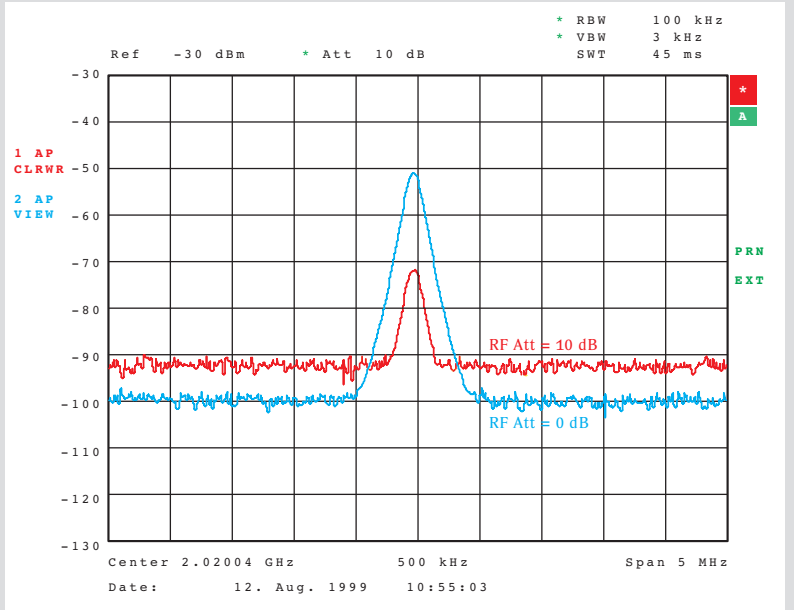

b)

Fig. 5-10 Identification of intermodulation products
 a) intermodulation products of DUT (measurement is correct)
 b) intermodulation products of analyzer (incorrect measurement)

5.3 Phase noise (spectral purity)

Phase noise is a measure for the short-time stability of oscillators. Phase noise is caused by variations of phase or frequency and amplitude of an oscillator output signal, although the amplitude effect is negligible in most cases. These variations have a modulating effect on the oscillator signal.

Phase noise is usually specified as single-sideband phase noise referred to the carrier level and as a function of the carrier offset. The specified values are stated as relative noise levels within a bandwidth of 1 Hz. Accordingly, the units are dBc (1 Hz) or dBc/Hz, where c is referred to the carrier. Since the phase noise level is lower than the carrier level, negative numeric values will be specified.

The effects of phase noise are shown in Fig. 5-11. Assuming a sufficiently high resolution, one would expect a single spectral line for a purely sinusoidal signal in the frequency domain. In fact, the spectrum of a signal generated by a real oscillator is wider than a single line.

An oscillator signal exhibits phase noise that may be more or less distinct. By choosing appropriate circuit configurations, phase noise can be minimized to a certain degree but never be fully eliminated. In modern spectrum analyzers the local oscillators are implemented as synthesizers locked to a high-precision reference (such as 10 MHz) via phase-locked loops (PLL) as described in [5-3]. The phase noise characteristic will be influenced by the PLL bandwidth of the frequency locking circuitry. The spectrum is divided into the following subranges (see Fig. 5-11):

- **Close to carrier** (offset approximately up to 1 kHz):

In this range the phase noise corresponds to the phase noise of the reference signal referred to the output signal of the local oscillator. Due to the multiplying effect in the PLL this phase noise is higher than that of the reference oscillator.

- **Range extending to the upper limit of the PLL bandwidth** (offset greater than 1 kHz)

Within the PLL bandwidth, the phase noise corresponds to the additive noise of several PLL components, such as divider, phase detector and of the multiplied reference signal. The upper limit of this range depends on the spectrum analyzer, or more precisely on the type of oscillator used. It is typically in the range between 100 kHz and 300 kHz.

- **Range outside the PLL bandwidth**

Outside the PLL bandwidth, the phase noise is practically exclusively determined by the phase noise of the oscillator in non-synchronized mode. In this range it decreases by 20 dB per decade.

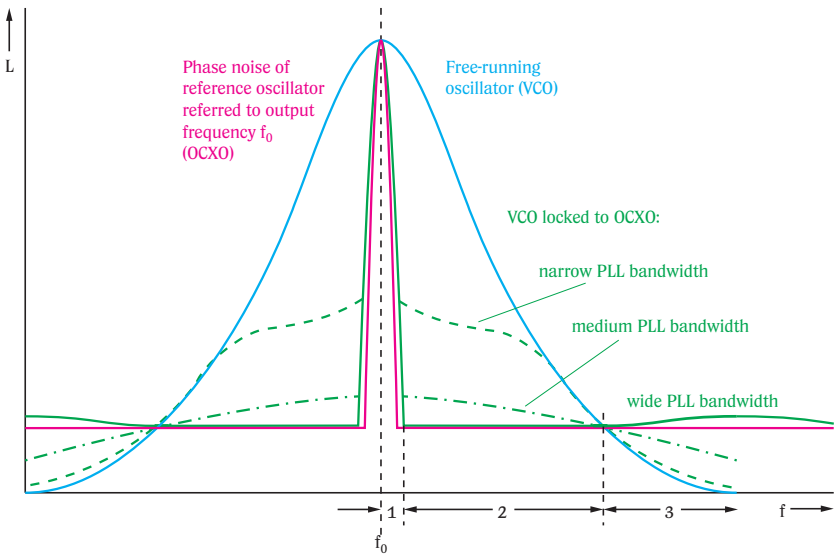

Fig. 5-11 Phase noise of OCXO, VCO and of VCO locked to OCXO at different PLL bandwidths

Fig. 5-11 shows the phase noise at different PLL bandwidths. It is of particular interest to compare the phase noise of a free-running oscillator with the phase noise of an oscillator locked to a reference oscillator at different PLL bandwidths. The following cases have to be considered:

• **Wide PLL bandwidth**

The loop gain of the PLL is so high that the oscillator noise is reduced to the reference oscillator noise. Due to the phase rotation of the filter circuit, the phase noise is increased far from the carrier.

• **Medium PLL bandwidth**

The loop gain is not sufficient to attain the reference oscillator noise close to the carrier. The increase of the phase noise far from the carrier is, however, much smaller than with a wide PLL bandwidth.

• **Narrow PLL bandwidth**

The phase noise far from the carrier is not degraded compared to the free-running oscillator. Close to the carrier it is, however, considerably higher than that with medium and wide PLL bandwidth.

To optimize the phase noise for the specific application, the PLL bandwidth should be variable.

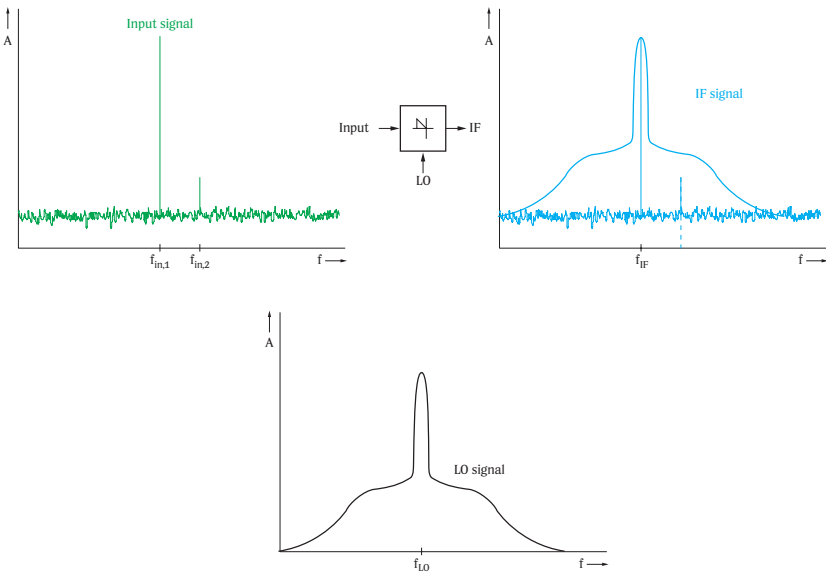

Fig. 5-12 Internal phase noise transferred onto input signal by reciprocal mixing

The LO phase noise of a spectrum analyzer is transferred onto the input signal by reciprocal mixing in the conversion stages (Fig. 5-12). This means that even with an ideal sinusoidal input signal, the displayed spectrum will reflect the combined phase noise of all LOs. If the input signal also exhibits phase noise (which in practice is always the case), the trace displayed on the spectrum analyzer corresponds to the combined phase noise of the input signal and LOs.

The displayed phase noise is always referred to the carrier of the input signal irrespective of the input signal level. This means that for phase noise measurements on input signals (chapter 6.1: Phase noise measurements) the dynamic range for close-to-carrier measurements cannot be maximized by increasing the input signal level - which is in sharp contrast to the effect of thermal noise.

In particular with measurements close to the carrier, the phase noise of the spectrum analyzers therefore marks the limit of the measurement range.

Apart from this restriction, the resolution and the dynamic range of the analyzer will also be limited by the phase noise. Signals with little offset from the carrier of a signal with much higher levels may not be detectable (Fig. 5-12).

Example:

A sinusoidal signal with a level of -10 dBm is present at the input of a spectrum analyzer. At a carrier offset of 100 kHz the phase noise of the spectrum analyzer is assumed to be -100 dBc (1 Hz).

What level must a second signal at the same offset of 100 kHz have to be detectable at a resolution bandwidth of 1 kHz (in our example the resolution bandwidth is assumed to correspond to the noise bandwidth of the filter)?

Solution:

Due to the resolution bandwidth of 1 kHz the phase noise produces a displayed noise level L_N of

$$L_N = -100 \text{ dBc (1 Hz)} + 10 \cdot \log \left(\frac{1 \text{ kHz}}{1 \text{ Hz}} \right) = -70 \text{ dBc (1 kHz)}$$

This means that the input signal must have at least a level $L_{S,\min}$ of $L_{S,\min} = -10 \text{ dBm} - 70 \text{ dBc (1 Hz)} = -80 \text{ dBm}$ in order to be detectable following a noise increase by 3 dB.

This limited resolution has also an adverse effect on adjacent-channel power measurements (chapter 6.3: Channel and adjacent-channel power measurement) since dynamic range is reduced by phase noise occurring in the adjacent channel.

Data sheets often specify residual frequency modulation (residual FM). From the carrier-offset-dependent phase noise, the RMS value of the residual FM can be calculated by integration as follows:

$$\Delta F_{RMS} = \sqrt{2 \cdot \int_{f_{off}=0}^{\infty} \left(10^{\frac{L(f_{off})}{20}} \cdot f_{off} \right)^2 df_{off}} \quad (\text{Equation 5-22})$$

- where ΔF_{RMS} = RMS value of residual FM, in Hz
- f_{off} = frequency offset from carrier, in Hz
- $L(f_{off})$ = phase noise as a function of carrier offset, in dBc (1 Hz)

Similarly, the RMS value of the residual phase modulation (residual ϕ M) can be calculated from the phase noise:

$$\Delta \phi_{RMS} = \sqrt{2 \cdot \int_{f_{off}=0}^{\infty} 10^{\frac{L(f_{off})}{10}} df_{off}} \quad , \text{ in rad} \quad (\text{Equation 5-23})$$

$$\Delta \phi_{RMS} = \sqrt{2 \cdot \int_{f_{off}=0}^{\infty} 10^{\frac{L(f_{off})}{10}} df_{off}} \cdot \frac{180}{\pi} \quad , \text{ in deg} \quad (\text{Equation 5-24})$$

- where $\Delta \phi_{RMS}$ = RMS value of residual ϕ M, in Hz
- f_{off} = frequency offset from carrier, in Hz
- $L(f_{off})$ = phase noise as a function of carrier offset, in dBc(1 Hz)

High residual FM of the LO signal may produce a smearing effect of the displayed spectrum. This leads to a reduction of the resolution and thus determines the lower limit for the useful smallest resolution bandwidth. Since in modern spectrum analyzers the local oscillators are implemented as synthesizers as described above, this effect is practically of no relevance.

Spectral purity (dBc (1 Hz))			
SSB phase noise, $f = 500$ MHz			
Carrier offset			
100 Hz			<-90. typ. -94
1 kHz			<-100. typ. -108
10 kHz			<-106. typ. -113
100 kHz ¹⁾			<-110. typ. -113
1 MHz ¹⁾			<-120. typ. -125
10 MHz			typ. -145
Residual FM ($f = 500$ MHz, RBW = 1 kHz, sweep time 100 ms)			typ. 3 Hz

Typical values for SSB phase noise			
Carrier offset	$f_{in} = 500$ MHz	$f_{in} = 3$ GHz	$f_{in} = 7$ GHz
100 Hz	94 dBc/Hz	90 dBc/Hz	84 dBc/Hz
1 kHz	105 dBc/Hz	100 dBc/Hz	94 dBc/Hz
10 kHz	113 dBc/Hz	108 dBc/Hz	104 dBc/Hz
100 kHz	113 dBc/Hz	108 dBc/Hz	106 dBc/Hz
1 MHz	125 dBc/Hz	118 dBc/Hz	118 dBc/Hz

1) Valid for span >100 kHz.

Fig. 5-13 Typical specifications for phase noise and residual FM of a spectrum analyzer (extract from data sheet)

In view of the above restrictions, phase noise is an essential criterion for evaluating a spectrum analyzer. Depending on the application, phase noise may be important for the user both in the case of small offsets (such as measurements on radar systems) and large offsets (such as measurements on mobile radio equipment). Data sheets therefore always provide specifications at different offsets, usually in decade steps (see Fig. 5-13).

As shown above, phase noise is largely influenced by the PLL bandwidth. In spectrum analyzers, the PLL bandwidth is usually variable to allow adaptation to the specific measurement task. Switchover is often implicit, as is illustrated with the analyzer described in our example. The PLL bandwidth is coupled to the frequency range to be displayed or to the selected resolution bandwidth. Especially if large frequency ranges are to be displayed (span >100 kHz, in our example), the minimum phase noise far from the carrier is usually of interest. Therefore a narrow PLL bandwidth is automatically selected for this setting.

To better define parameter dependencies, resolution bandwidths and span settings are often stated in data sheets in addition to the phase noise at the various carrier offsets. Settings other than those specified may result in poorer phase noise values.

For analyzing input signals of very high frequency, the LO signal must be multiplied (chapter 4.1). Just as it is found in a frequency-modulated signal, the frequency deviation is multiplied, thus causing degrading of the phase noise. The following applies:

$$L_{mult}(f_{off}) = L(f_{off}) + 20 \cdot \log(n) \quad \text{(Equation 5-25)}$$

- where $L_{mult}(f_{off})$ = phase noise after multiplication as a function of carrier offset, in dBc (1 Hz)
- $L(f_{off})$ = phase noise of original signal as a function of carrier offset, in dBc (1 Hz)
- n = multiplying factor

Due to this degradation, phase noise specifications are always referred to a specific signal frequency. Typical phase noise curves are often given for several signal frequencies, allowing an estimation of the expected phase noise in the frequency range of interest.

5.4 1 dB compression point and maximum input level

The 1 dB compression point of a network marks the point in its dynamic range at which the gain is reduced by 1 dB due to saturation (Fig. 5-14). Similar to the intercept point, the 1 dB compression point can be referred to the input or to the output level. For power amplifiers, the output level at which the 1 dB compression occurs is usually given, and the input level is specified for spectrum analyzers.

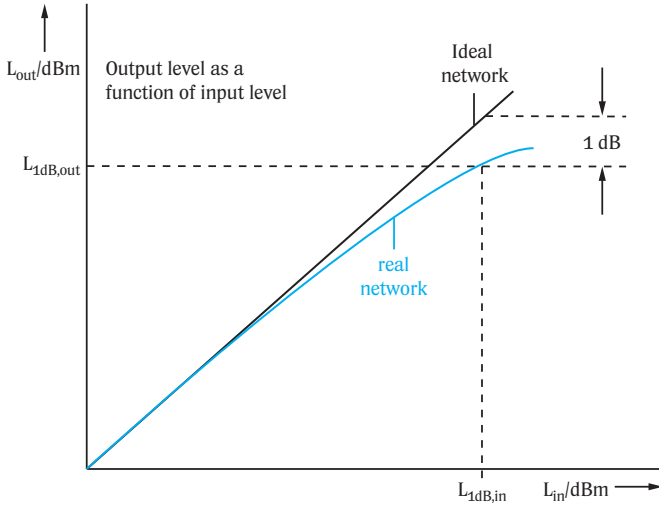

Fig. 5-14 1 dB compression point

Maximum input level	
RF attenuation 0 dB	
DC voltage	50 V
CW RF power	20 dBm (~ 0.3 W)
Pulse spectral density	97 dB μ V/MHz
RF attenuation 10 dB	
CW RF power	30 dBm (~ 1 W)
Max. pulse voltage	150 V
Max. pulse energy (10 μ s)	1 mWs
1 dB compression of output mixer	
0 dB RF attenuation, $f > 200$ MHz	0 dBm nominal

Fig. 5-15 Typical specifications for 1 dB compression point and maximum input level (extract from data sheet)

The 1 dB compression point is primarily determined by the first mixer and usually specified at an attenuator setting of 0 dB. The specified input level is also referred to as mixer level. By increasing the RF attenuation, the 1 dB compression point is increased to the same amount of the attenuation level.

To avoid unwanted products due to distortion, the maximum input level (reference level) to be displayed should be kept clearly below the 1 dB compression point.

Due to the coupling of reference level and attenuator setting (chapter 4.6: Parameter dependencies), the maximum reference level is limited (in our example to -10 dBm) with an RF attenuation of 0 dB. The 1 dB compression point cannot be measured directly. Nevertheless, it is an important criterion in many measurements.

For example, when making phase noise measurements a single sinusoidal signal is applied to the spectrum analyzer input. Even when driving the spectrum analyzer close to its 1 dB compression point, no intermodulation products will be generated that would appear in the vicinity of the input signal. Given the wide dynamic range, only harmonics of the input signal will be produced in the spectrum analyzer, which usually do not degrade phase noise measurements. The wide dynamic range makes for a large signal-to-noise ratio so that the maximum dynamic range at large carrier offsets is obtained for measurements.

In contrast to the 1 dB compression point, which provides information about the overdrive capacity of the spectrum analyzer, the maximum input level denotes the upper limit for damage-free operation. To avoid damage to the analyzer, this value should not be exceeded.

The limit value is usually determined by the first critical component in the signal processing chain. Accordingly, the selected RF attenuation has always to be taken into account:

- **RF attenuation 0 dB**

The attenuator is not loaded in this case and the input signal is not attenuated. Therefore the first mixer is usually decisive for the maximum input level. Due to the generally high load capacity of diplexer and tracking band-pass filter, the same holds true for the high-frequency input section (above 3 GHz in our example).

- **RF attenuation >0 dB (≥ 10 dB in our example)**

The input signal is attenuated by the attenuator so that the subsequent stages can usually be ignored. The specified value reflects the load capacity of the attenuator.

Both of the above cases are important for practical operation, so they are specified separately in data sheets.

Further distinction is made as to the type of the input signal (Fig. 5-15):

DC voltage

For DC-coupled spectrum analyzers this value corresponds to the maximum mixer-compatible DC voltage. Usually a value of 0 V is specified irrespective of the RF attenuation.

For AC-coupled spectrum analyzers the specified value corresponds to the dielectric strength of the coupling capacitor at the spectrum analyzer input. In the above data sheet extract a value of 50 V is specified.

Continuous wave (CW) RF power

This value specifies the maximum total power of all input signals that is permissible without any time limit. It is assumed that all input signals are stationary.

Pulse spectral density

Pulsed signals feature a very wide spectrum with many spectral components whose sum power should not exceed a specific value. For pulse spectra, a spectral density is usually specified as the voltage level referred to a specific bandwidth, typically 1 MHz. In the above data sheet extract (Fig. 5-15), 97 dB μ V/MHz is specified as the limit value.

Maximum pulse energy and maximum pulse voltage

With extremely short pulses, the pulse power may exceed the value specified for the CW RF power for long intervals of time. There is a limiting threshold set by the maximum pulse energy, in our example specified in mWs for a certain pulse period, as well as by the maximum pulse voltage.

Often the maximum pulse power is specified which can be calculated from the pulse energy and pulse period as follows:

$$P_p = \frac{E_p}{t_p} \quad \text{and} \quad E_p = P_p \cdot t_p \quad \text{(Equation 5-26)}$$

where P_p = pulse power, in W
 E_p = pulse energy, in Ws
 t_p = pulse period, in s

With the values specified in the data sheet extract in Fig. 5-15 ($E_p = 1$ mWs, $t_p = 10 \mu\text{s}$) a maximum pulse power of 100 W is obtained.

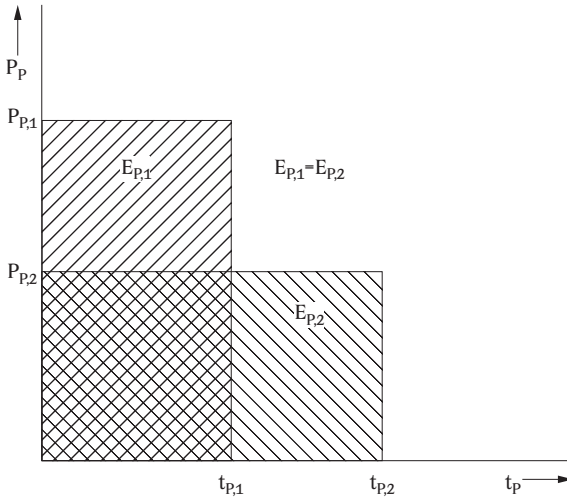

Fig. 5-16 Pulses with different pulse width but equal pulse energy

For constant pulse energy E_p , the permissible pulse power is even higher for a short pulse period according to Equation 5-26 (Fig. 5-16).

By decreasing the pulse period, the pulse power may not be increased arbitrarily since the maximum permissible pulse voltage must not be exceeded. In the cited specifications, a value of 150 V is stipulated. For the rectangular pulse as shown in Fig. 5-16, the permissible peak voltage yields a maximum pulse power of

$$P_p = \frac{\hat{U}_p^2}{R} = \frac{(150 \text{ V})^2}{50 \Omega} = 450 \text{ W} \quad \text{(Equation 5-27)}$$

where \hat{U}_p = pulse peak voltage, in V
 R = input impedance of spectrum analyzer, in Ω

This maximum pulse power, as well as the maximum permissible pulse energy (1 mWs in our example), should not be exceeded under any circumstances. Equation 5-26 can be used to calculate the maximum pulse period for a pulse of maximum pulse power, which in our example is 2.2 μ s.

For longer pulse periods and constant pulse energy, the pulse power has to be reduced. The relationship shown in Fig. 5-17 is then obtained (valid for the specifications given in Fig. 5-15).

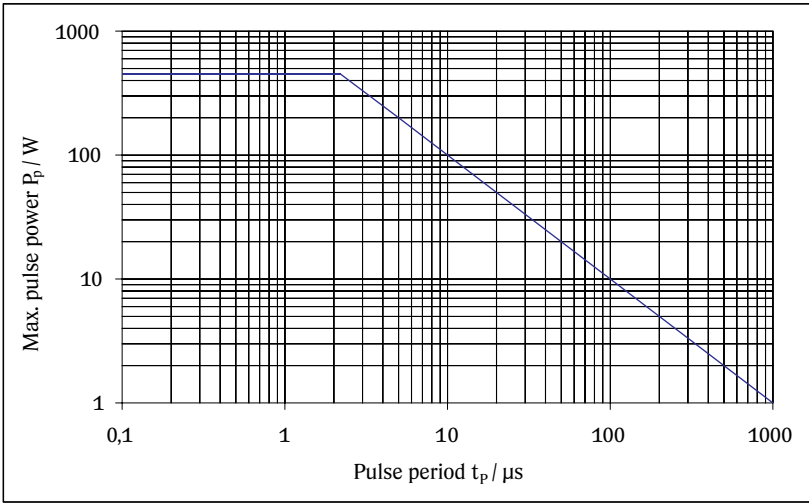

Fig. 5-17 Maximum pulse power as a function of pulse period (for max. pulse voltage of 150 V and max. pulse energy of 1 mWs)

5.5 Dynamic range

The dynamic range provides information about the analyzer’s capability to simultaneously process signals with very different levels. The limits of the dynamic range depend on the measurement to be performed. The lower limit is determined by the inherent noise or phase noise. The upper limit is set either by the 1 dB compression point or by distortion products occurring in the analyzer in the case of overdriving. The dynamic range can be defined in different ways. It should not be confused with the display range.

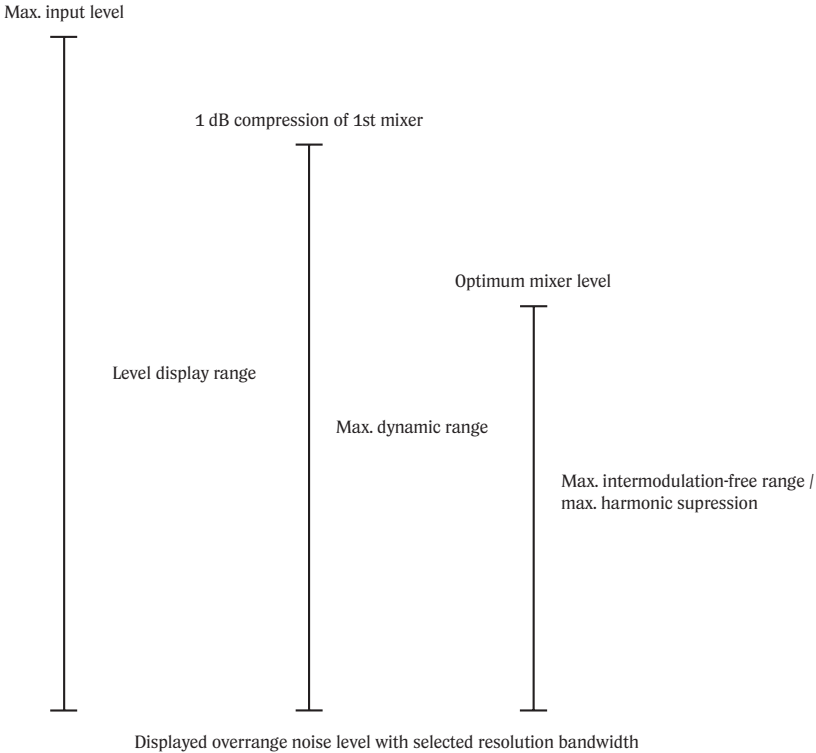

Fig. 5-18 Comparison of level display range, maximum dynamic range and max. intermodulation-free range

Level display range

The dynamic range does not correspond to the level display range which is also specified in data sheets. The display range is the range from the displayed average noise level to the maximum input level (Fig. 5-18). For displaying a signal with a level corresponding to the maximum input level of the analyzer, an RF attenuation greater than 0 dB is usually selected, which means that the minimum displayed noise (the lower limit of the specified level display range) will not be attained.

Maximum dynamic range

A maximum dynamic range is often specified which is limited by the displayed noise (usually at the smallest resolution bandwidth) and the 1 dB compression point (Fig. 5-18). If, however, an input signal at the first mixer reaches the mixer's 1 dB compression point, there will be very high levels of the distortion products generated due to nonlinearities of the mixer.

Using sufficiently small bandwidth, the distortion products can become visible in the displayed spectrum (they are not covered up by the inherent noise). The spectrum display is then no longer unambiguous.

In modern spectrum analyzers, the reference level selectable for a given RF attenuation is therefore limited even with manual decoupled attenuator setting. Signals attaining the 1 dB compression point at the mixer input considerably exceed the reference level.

The value stated for the maximum dynamic range is therefore of limited significance and only relevant for certain applications, such as phase noise measurements far from the carrier.

Maximum intermodulation-free range for maximum harmonic suppression

A compromise has to be found in the selection of the mixer level. If the RF attenuation is high, so that the mixer level is low, the levels of the distortion and intermodulation products generated in the analyzer are also low, but at the same time the signal-to-noise ratio of the input signal is small. In this case the dynamic range is limited at the lower end by the inherent noise. If, on the other hand, the mixer level is high, then distortion and intermodulation products are generated whose levels exceed the inherent noise level and therefore become visible (Fig. 4-31). In practice, it is important to have a level display range in which the displayed spectrum is free from such products. Depending on whether intermodulation products or harmonics of higher order limit this range, one speaks of an intermodulation-free range or maximum harmonic suppression. Both parameters depend on the mixer level and the selected resolution bandwidth. A maximum is attained if the levels of the intermodulation products or harmonics of higher order are equal to the noise level. The ideal mixer level required for this purpose can either be calculated or graphically determined. For elucidation the graphical method is described first.

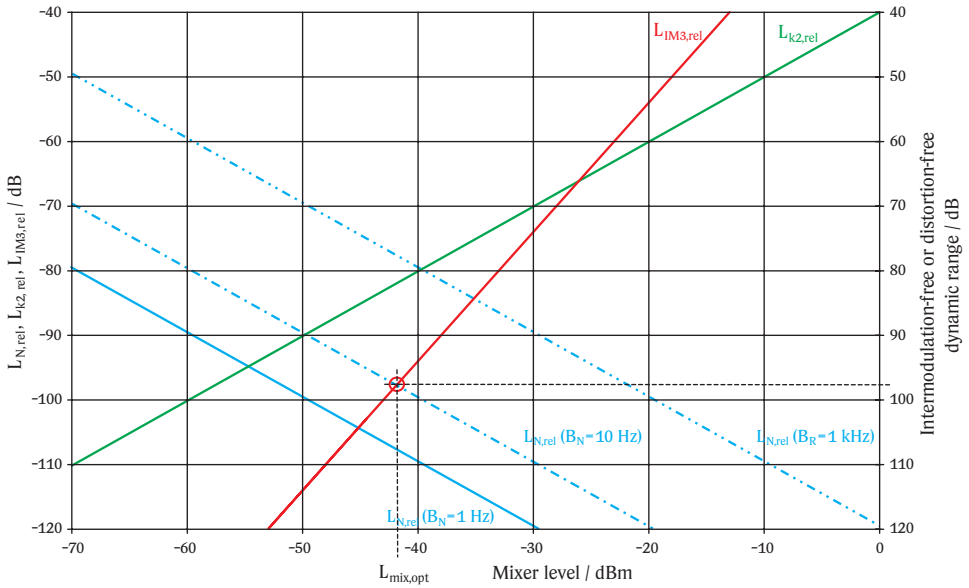

Fig. 5-19 Intermodulation-free range and maximum harmonic suppression as a function of mixer level ($NF = 24.5 \text{ dB}$, $IP3_{in} = 7 \text{ dBm}$, $SHI_{in} = 40 \text{ dBm}$)

For a given noise bandwidth of the IF filter and noise figure of the spectrum analyzer, the noise power level is to be calculated relative to the mixer level using the following:

$$L_{N,rel} = L_R - L_{mix} = -174 \text{ dBm} + 10 \cdot \log(B_{N,IF}) + NF - L_{mix} \quad (\text{Equation 5-28})$$

- where $L_{N,rel}$ = relative noise level referred to mixer level, in dB
- L_{mix} = mixer level, in dBm
- L_N = noise level, in dBm
- $B_{N,IF}$ = noise bandwidth of resolution filter, in Hz
- NF = noise figure of spectrum analyzer, in dB

When using a sample detector and averaging by a narrowband video filter, a further 2.5 dB is to be subtracted from the calculated value $L_{N,rel}$ due to underweighting of the noise. The relative noise level is plotted in Fig. 5-19 for different resolution filters versus the mixer level. A noise figure of 24.5 dB is assumed in this example. It is shown that the relative noise level decreases with increasing mixer level.

The following relationship can be derived from Equation 5-16 for the relative level of n th order intermodulation products referred to the mixer level:

$$L_{IMn,rel} = -(n - 1) \cdot (IPn_{in} - L_{mix}) \quad \text{(Equation 5-29)}$$

where $L_{IMn,rel}$ = relative level of n th order intermodulation products referred to mixer level, in dB
 IPn_{in} = input intercept point of n th order of spectrum analyzer (RF attenuation 0 dB),
 L_{mix} = mixer level, in dBm

Usually the 3rd order intermodulation products are the most disturbing ones in practice since they occur in the immediate vicinity of the input signals. The relative level of such products is given by:

$$L_{IM3,rel} = -2 \cdot (IP3_{in} - L_{mix}) \quad \text{(Equation 5-30)}$$

Likewise, the relative level of 2nd order distortion products (2nd order harmonics) can be derived from Equation 5-13:

$$L_{k2,rel} = -(SHI_{in} - L_{mix}) \quad \text{(Equation 5-31)}$$

where $L_{k2,rel}$ = relative level of 2nd order distortion products referred to mixer level, in dB
 SHI_{in} = input second harmonic intercept of spectrum analyzer, in dBm

Since the distortion and intermodulation products are always calculated from the mixer level, the results are independent of the RF attenuation setting. Therefore, the intercept points referred to the input of the first mixer have to be substituted for $IP3_{in}$ and SHI_{in} . The values correspond to the intercept points of the analyzer with a RF attenuation of 0 dB.

The relative level of the 3rd order intermodulation products as well as of the 2nd harmonics are shown in Fig. 5-19 as a function of the mixer level. For $IP3_{in}$, a value of 7 dBm has been assumed. SHI_{in} is 40 dBm.

Depending on the specific measurement application, 3rd order intermodulation products or harmonics of higher order may limit the dynamic range. The optimum mixer level for the specific application and hence the maximum attainable dynamic range is obtained from the point of intersection of the noise level line and the line of the 3rd order intermodulation products or 2nd order harmonics. At this point of intersection, the level of the intermodulation or distortion products is equal to the noise level, and the representation is still unambiguous.

In Fig. 5-19, a maximum intermodulation-free range of about 98 dB can be found at the noise bandwidth of 10 Hz. A mixer level of -42 dBm is required for this range. If two sinusoidal signals each having a level of -42 dBm are applied to the spectrum analyzer (RF attenuation 0 dB), the 3rd intermodulation products will attain a level of -42 dBm - 98 dB = -140 dBm.

The optimum mixer level and the attainable dynamic range can also be calculated.

With optimum mixer level, the noise level corresponds to the level of the intermodulation products. Equation 5-28 and Equation 5-29 have to be equated and solved for L_{mix} . This yields

$$L_{mix,opt} = \frac{(n - 1) \cdot IPn_{in} + L_{N,rel}}{n} = \frac{(n - 1) \cdot IPn_{in} - 174 \text{ dBm} + 10 \cdot \log(B_{N,IF}) + NF}{n} \quad (\text{Equation 5-32})$$

- where
- $L_{mix, opt}$ = optimum mixer level, in dBm
 - IPn_{in} = input intercept point of nth order of spectrum analyzer (RF attenuation 0 dB), in dB
 - n = order of intermodulation or distortion products by which the dynamic range is limited
 - $B_{N,IF}$ = noise bandwidth of resolution filter, in Hz
 - NF = noise figure of spectrum analyzer, in dB

For $n = 3$, that is limitation of the intermodulation-free range by 3rd order intermodulation products, the following is obtained:

$$L_{mix,opt} = \frac{2 \cdot IP3_{in} + L_{N,rel}}{3} = \frac{2 \cdot IP3_{in} - 174 \text{ dBm} + 10 \cdot \log(B_{N,IF}) + NF}{3} \quad (\text{Equation 5-33})$$

The optimum mixer level for maximum harmonic suppression is given by

$$L_{mix,opt} = \frac{SHI_{in} + L_{N,rel}}{2} = \frac{SHI_{in} - 174 \text{ dBm} + 10 \cdot \log(B_{N,IF}) + NF}{2} \quad (\text{Equation 5-34})$$

With optimum mixer level, the dynamic range corresponds to the level difference between mixer level and nth order intermodulation products or noise level. The following applies:

$$DR_{max} = \frac{n-1}{n} \cdot (IPn_{in} - L_N) = \frac{n-1}{n} \cdot (IPn_{in} + 174 \text{ dBm} - 10 \cdot \log(B_{N,IF}) - NF) \quad (\text{Equation 5-35})$$

- where
- DR_{max} = maximum dynamic range, in dB
 - IPn_{in} = input intercept point of nth order of spectrum analyzer (RF attenuation 0 dB), in dB
 - n = order of intermodulation or distortion products by which the dynamic range is limited
 - $B_{N,IF}$ = noise bandwidth of resolution filter, in Hz
 - NF = noise figure of spectrum analyzer, in dB

For $n = 3$, a maximum intermodulation-free range of

$$DR_{max} = \frac{2}{3} \cdot (IP3_{in} - L_N) = \frac{2}{3} \cdot (IP3_{in} + 174 \text{ dBm} - 10 \cdot \log(B_{N,IF}) - NF) \quad (\text{Equation 5-36})$$

or (with $n = 2$) a maximum harmonic suppression of

$$DR_{max} = \frac{1}{2} \cdot (SHI_{in} - L_N) = \frac{1}{2} \cdot (SHI_{in} + 174 \text{ dBm} - 10 \cdot \log(B_{N,IF}) - NF) \quad (\text{Equation 5-37})$$

can be derived.

Equation 5-35 reveals that both a high intercept point and a low noise figure are required to obtain a high intermodulation-free range. For fast assessment of the dynamic range of a spectrum analyzer a figure of merit (FOM) can be used as follows:

$$FOM = IP3_{in} - NF \quad (\text{Equation 5-38})$$

Modern high-end analyzers attain a figure of merit of 0 dBm with a typical 3rd order intercept point of 15 dBm and typical noise figure of 15 dB.

The above discussions regarding the dynamic range were with reference to the signal level at the input of the first mixer. If the signal level at the spectrum analyzer input is higher than the optimum mixer level, it must be reduced by an appropriate RF attenuation. The required RF attenuation can be calculated as follows:

$$a_{RF} = L_{in} - L_{mix} \tag{Equation 5-39}$$

- where a_{RF} = RF attenuation, in dB
- L_{in} = signal level at spectrum analyzer input, in dBm
- L_{mix} = mixer level to be set, in dBm

When setting the mixer level, the attenuator steps are important:

If in the above example the input level is -17 dBm and the attenuator steps are 10 dB, the signal level can only be reduced to a mixer level of -37 dBm (with 20 dB RF attenuation) or -47 dBm (with 30 dB RF attenuation). Accordingly, the intermodulation-free range is then 92 dB ($L_{mix} = -47$ dBm) or 88 dB ($L_{mix} = -37$ dBm). To utilize the maximum intermodulation-free range, the level can be reduced to -22 dBm by means of an external 5 dB attenuator. By applying an RF attenuation of 20 dB, the optimum mixer level of -42 dBm and an intermodulation-free range of 98 dB are obtained again.

For some spectrum analyzers, an attenuator with 1 dB steps is available. It is then not necessary to use external attenuator pads or an external RF attenuator.

Effects of phase noise on dynamic range

As described in chapter 5.3, the phase noise of the local oscillators of the spectrum analyzer is transferred onto the input signals by reciprocal mixing. The dynamic range for phase noise measurements on input signals is therefore limited by the spectrum analyzer phase noise - in particular at small carrier offsets. The phase noise of the DUT must be higher than that of the measuring instrument for accurate measurements (chapter 6.1: Phase noise measurements).

If weak signals in the immediate vicinity of very strong input signals are to be displayed (such as for measuring the 3rd intercept point of a DUT), the phase noise of the analyzer needs to be as low as possible. Otherwise, the weak input signal may be covered up by the phase noise transferred onto the strong neighboring signal (Fig. 5-12). The phase noise should be accounted for in such cases in the calculation of the dynamic range.

Since the phase noise transferred onto the input signal depends on the signal carrier level, varying the carrier level cannot influence the phase noise effect. In Fig. 5-20, the phase noise contribution is represented accordingly as a horizontal line. If the signal frequency is greater than the carrier offset at which measurements on weak signals are to be performed, harmonics and 2nd order intermodulation products are insignificant. In Fig. 5-20, only 3rd order intermodulation products are therefore taken into account. The phase noise level has to be calculated for the given resolution bandwidth. The following applies:

$$L_{PN,RBW}(f_{off}) = L(f_{off}) + 10 \cdot \log(B_{N,IF}) \quad (\text{Equation 5-40})$$

where $L_{PN,RBW}(f_{off})$ = phase noise as a function of carrier offset within bandwidth $B_{N,IF}$, referred to carrier, in dBc
 $L(f_{off})$ = phase noise as a function of carrier offset, in dBc (1 Hz)
 $B_{N,IF}$ = noise bandwidth of IF filter, in Hz
 f_{off} = carrier offset

The effects of thermal noise, intermodulation products and phase noise have to be added linearly.

The sum trace (L_{sum}) represented in Fig. 5-20 holds true for a phase noise of -122 dBc (1 Hz), a 3rd order intercept point of 7 dBm and a noise figure of 24.5 dB. The selected resolution bandwidth of 10 kHz should correspond to the noise bandwidth. Maximum dynamic range is attained at a mixer level at which the combined trace is at its minimum.

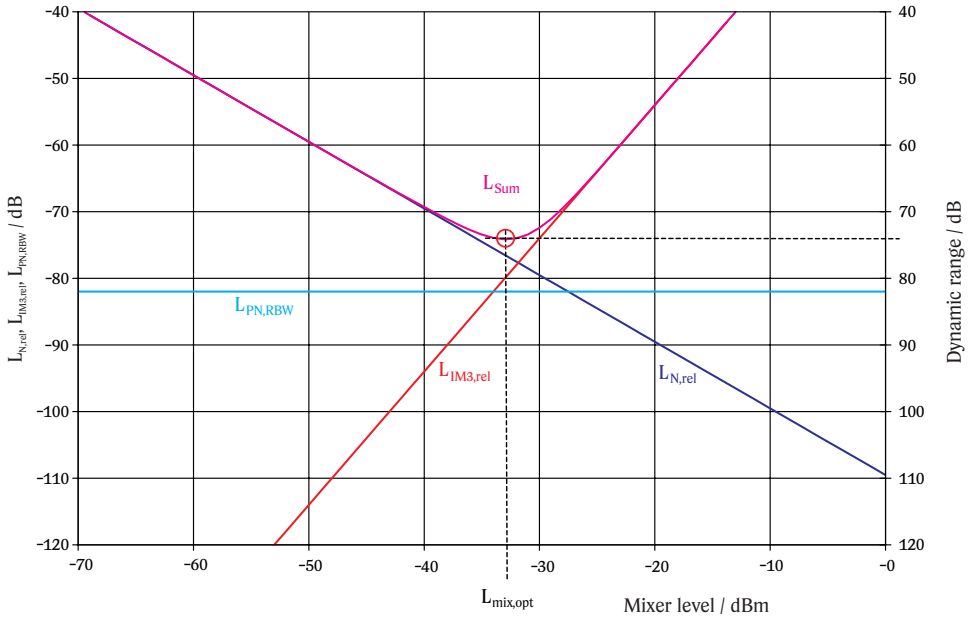

Fig. 5-20 Dynamic range taking into account thermal noise, phase noise and 3rd order intermodulation products ($NF = 24.5$ dB, $IP3_{in} = 7$ dBm, $L(f_{off}) = -122$ dBc (1Hz), $B_{N,IF} = 10$ kHz)

Similarly, the dynamic range for adjacent-channel power measurements is limited by phase noise. Further details on the dynamic range for this type of measurement can be found in chapter 6.3: Channel and adjacent-channel power measurements.

For the simple determination of the dynamic range as a function of noise figure, 3rd order intercept point and phase noise of the spectrum analyzer, a spreadsheet in MS Excel® 5.0 is available (file DYN_CALC.XLS, Fig. 5-21) which can be obtained via the R&S Web site (www.rohde-schwarz.com). In the spreadsheet 2nd order harmonics are taken into account, so that the

dynamic range can easily be calculated for practically any application. The spreadsheet consists of two sheets:

- **Input & Diagram:** Input of noise bandwidth, noise figure, IP3, SHI and phase noise of the spectrum analyzer (Fig. 5-21a, yellow highlighted fields top left). Graphical output of relative noise level referred to input signal level, phase noise level as well as relative levels of 2nd harmonics and 3rd order intermodulation products. Additionally, the sum of the contributions of thermal noise, phase noise and 3rd order intermodulation products is available.
- **Num. Results:** Numeric output of results, which are graphically available on the Input & Diagram sheet.

The phase noise value to be entered depends on the frequency offset from the strong signal at which a weak signal is to be represented.

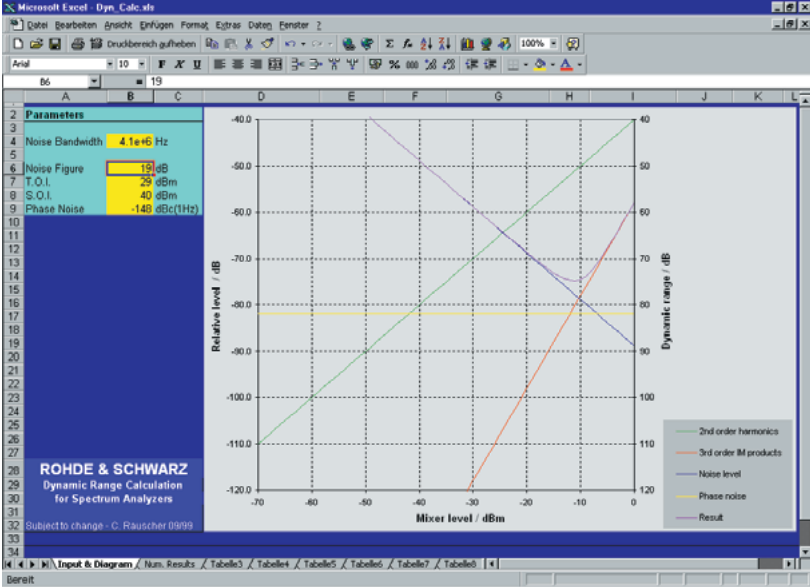

a)

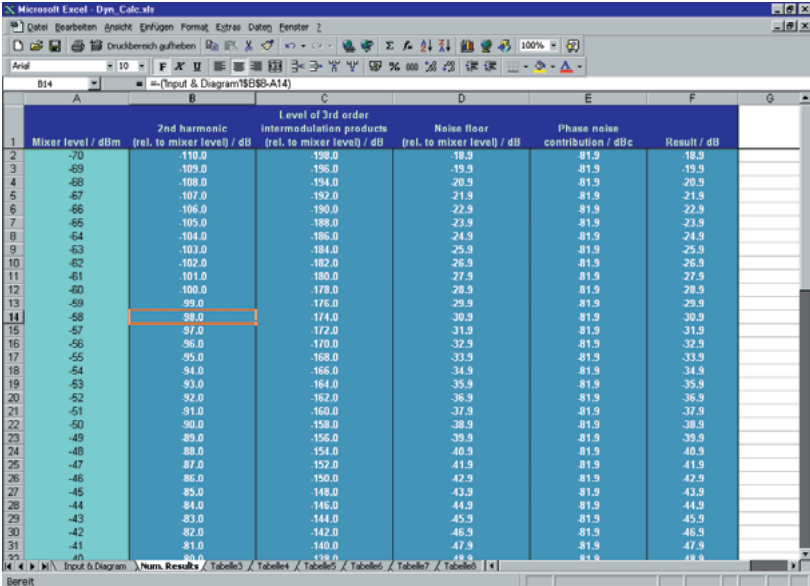

b)

Fig. 5-21 Spreadsheet DYN_CALC.XLS

(a) Input & Diagram sheet: input fields for noise bandwidth, noise figure, TOI, SHI and phase noise as well as graphical representation of resulting dynamic range
 (b) Num. Results sheet: numeric output of results

5.6 Immunity to interference

The signal at the spectrum analyzer input may give rise to unwanted components which spectrally do not show any relationship to the input signal. There are different causes for such unwanted components which are to be dealt with in the following section. Unlike harmonics or intermodulation products generated in the spectrum analyzer due to nonlinearities, immunity to interference cannot as a rule be improved by optimizing the mixer level as it is usually independent of the selected RF attenuation.

Immunity of interference	
Image frequency	>70 dB
Intermedial frequency	>70 dB
Spurious responses (f >1 MHz, without input signal, 0 dB attenuation)	<-103 dBm
Other spurious with input signal, mixer level <-10 dBm, Δf >100 kHz	<-70 dBc

Fig. 5-22 Typical data sheet specifications for immunity to interference

Image frequency

As described in chapter 4, the conversion of a signal by mixing is not unambiguous. At a given LO frequency, there is always an image frequency in addition to the wanted signal frequency. From Equation 4-4 and Equation 4-5 the following relationship between image frequency and input frequency can be derived:

$$f_{im} = f_{in} + 2 \cdot f_{1stIF} \tag{Equation 5-41}$$

Input signals at the image frequency are suppressed by suitable filters depending on the configuration of the front end as described in chapter 4.1. Due to the limited isolation of technically feasible filters, the achievable suppression has its limits. In the above data sheet extract, a value of >70 dB is specified.

Applied to the analyzer described in chapter 4, this means that an input signal with a frequency of 7100 MHz and level of -10 dBm will cause in the displayed spectrum a response at 1472 MHz with a maximum level of (-10 dBm - 70 dB) = -80 dBm.

As shown in chapter 4.1, an image frequency also occurs in the second conversion and has to be suppressed accordingly. For the analyzer described in our example, the following relationship can be derived for the frequency the input signal must have to be converted to the image frequency of the second mixer and to become visible at the frequency f_{in} :

$$f_{im,2ndIF} = f_{in} + 2 \cdot f_{2ndIF} \tag{Equation 5-42}$$

- where
- $f_{im,2ndIF}$ = spurious response due to image frequency at 2nd IF
 - f_{in} = frequency at which spurious response becomes visible in displayed spectrum
 - f_{2ndIF} = second intermediate frequency

IF feedthrough or reception at intermediate frequency

Due to the limited isolation between the RF input and IF output of the first mixer, input signals may be fed through directly (without conversion) to the IF (chapter 4.1), which is known as the IF feedthrough. If the frequency of an input signal corresponds to the first IF, the signal will be reproduced in the frequency range of the displayed spectrum irrespective of the LO frequency. Signals with a frequency corresponding to the first IF therefore must be suppressed before the first mixer by appropriate filters which are required for image frequency rejection. The analyzer described here uses an input lowpass filter (3) for this purpose in the RF input section for up to 3 GHz and a tracking bandpass filter (20) for the frequency range above 3 GHz. The signals to be suppressed are at 3476.4 MHz and 404.4 MHz.

In the above data sheet extract, a value of >70 dB is specified for the immunity to interference at the IF. This means that for an input signal of 3476.4 MHz and -10 dBm, a maximum value of -80 dBm will be displayed in the frequency range 9 kHz to 3 GHz.

Spurious responses

Inherent spurious responses

Inherent spurious responses are signals in the displayed spectrum that are generated in the spectrum analyzer itself. They are caused, for instance, by clock signals of microprocessors, which may be propagated via supply voltage lines and coupled into the analog signal processing circuitry. Distinction has to be made whether inherent spurious responses are permanently present or only occur if a signal is present at the input of the spectrum analyzer. Spurious of local oscillators belong to the latter group. Data sheet specifications for inherent spurious responses produced by the input signal are therefore related to the carrier level of the input signal (in dBc). In the data sheet extract shown in Fig. 5-22, a value of -70 dBc is specified, and for inherent spurious responses that are independent of the input signal -103 dBm is given.

Spurious responses

Harmonics of the input signal are produced among others in the first mixer of the spectrum analyzer. If the input level is sufficiently high, the harmonics will be displayed. Harmonics of the input signal are converted to the first intermediate frequency by means of the fundamental and the harmonics of the LO signal according to Equation 4-1. For input frequencies $f_{in,N}$, for which Equation 4-1 is fulfilled with $m \geq 1$ and $n > 1$ at a given IF and LO frequency range, spurious responses are generated.

Example:

A spectrum analyzer for the frequency range of 10 MHz to 5 GHz converts the input signal to a high first IF of 5.8 GHz with the aid of a LO signal tunable from 5.81 GHz to 10.8 GHz. A signal of 3.87 GHz is applied to the analyzer input and displayed at a frequency of 3.87 GHz.

Simultaneously, higher-order harmonics of the signal are produced in the first mixer of the analyzer. The 3rd harmonic, for instance, is at 11.61 GHz. If the analyzer is tuned to an input frequency of 10 MHz, the LO frequency is 5.81 GHz. The 3rd harmonic of the input signal is thus converted to the IF:

$$f_{IF} = 3 \cdot f_{in} - f_{LO} = 3 \cdot 3.87 \text{ GHz} - 5.81 \text{ GHz} = 5.80 \text{ GHz}$$

The input signal at 3.87 GHz also causes a spurious response at 10 MHz in the displayed spectrum.

Such spurious responses are inherent in the concept. To avoid the generated spurious from disturbing the displayed spectrum, particularly stringent requirements have to be observed for the first mixer of the spectrum analyzer regarding linearity – specifically intercept point. At the same time, the mixer level should not be too high, which is a requirement that can be fulfilled by appropriate setting of the RF attenuation.

5.7 LO feedthrough

In passive mixers as used in spectrum analyzers for the first conversion of the input signal, the LO signal is coupled into the IF path due to its limited isolation. The block diagram of the analyzer described (see fold-out page) shows that if very low-frequency input signals are converted (such as 9 kHz), the frequency of the LO signal (3476.409 MHz, in our example) corresponds to the first IF. Especially with large resolution bandwidths ($0.5 \cdot B_{IF} > f_{in}$) the LO signal coupled into the IF path is therefore only slightly suppressed by the IF filter. The LO signal is then sent to the detector and displayed (Fig. 5-23). This effect is referred to as LO feedthrough. Due to the phase noise of the LO signal, the displayed average noise level close to the minimum start frequency is increased and as a result the sensitivity in this frequency range decreased. The LO feedthrough is usually not stated explicitly in data sheets. It can, however, be recognized from the displayed noise level specified for the frequency range close to zero.

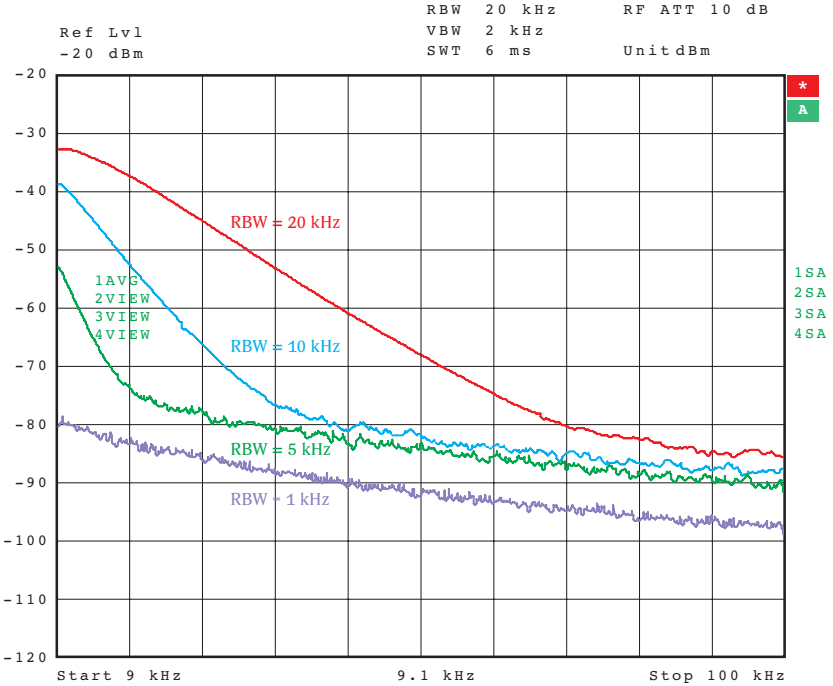

Fig. 5-23 LO feedthrough as a function of selected resolution bandwidth

The LO feedthrough can be reduced by reducing the resolution bandwidth as shown in Fig. 5-23.

For spectrum analyzers featuring a very low input frequency limit, such as 20 Hz, this is possible to a limited extent only. Due to the very narrow resolution bandwidths required to reduce the LO feedthrough, the sweep time is drastically increased. Therefore complex circuitry is often implemented in such analyzers in order to reduce the LO feedthrough. The LO signal can, for instance, be coupled into the IF path with opposite phase, thus causing partial cancellation and LO suppression.

5.8 Filter characteristics

The main characteristics and different methods of implementing resolution filters have been described in chapter 4.2. In addition to the shape

factor, which determines the selectivity characteristics, the minimum and maximum resolution bandwidths of a spectrum analyzer play an important role. For measurements requiring high sensitivity, very narrow bandwidths are needed (chapter 5.1), whereas for pulse measurements and measurements in the time domain (chapters 6.2 and 6.3), very large resolution bandwidths are necessary.

To allow shorter sweep times, FFT filters are advantageous for narrow resolution bandwidths. However, it is essential that there is also a choice of analog or digital filters as it may not be possible, for instance, to carry out pulse measurements with FFT filters (chapter 3.1).

The accuracy of the bandwidth is important for applications where a measured signal level is referred to the measurement bandwidth. The accuracy is usually stated as a percentage. The method of calculating the measurement accuracy is described in detail in chapter 5.10.

5.9 Frequency accuracy

The local oscillators in modern spectrum analyzers are synchronized to a stable reference oscillator via phase-locked loops. The frequency accuracy of the spectrum analyzer thus corresponds to the accuracy of this reference and is also influenced by the temperature and long-term stability of the reference.

References, usually at a frequency of 10 MHz, are implemented as temperature-compensated crystal oscillators (TCXO) or oven-controlled crystal oscillators (OCXO). The generated reference frequency depends on the ambient temperature and varies due to aging during operation. To ensure a high absolute frequency accuracy of the spectrum analyzer, the reference frequency has to be adjusted at regular intervals. With modern spectrum analyzers, the user can make this adjustment with a D/A converter provided that a frequency counter or signal of known frequency is available.

Internal reference frequency (nominal)	
Aging per year ¹⁾	$1 \cdot 10^{-6}$
Temperature drift (+5 °C to 45 °C)	$1 \cdot 10^{-6}$
with optional OCXO	
Aging per year ¹⁾	$1 \cdot 10^{-7}$
Temperature drift (+5 °C to 45 °C)	$1 \cdot 10^{-8}$

¹⁾ After 30 days of operation.

Fig. 5-24 Typical specifications of frequency accuracy of spectrum analyzers

Fig. 5-24 shows a data sheet extract with frequency accuracy specifications for a spectrum analyzer. A distinction is made between the accuracy of the basic unit and the accuracy with built-in optional OCXO. It can be seen that with an OCXO, a much higher temperature stability and a much smaller temperature drift are achieved. The total frequency error is made up of temperature drift and long-term stability. The long-term stability is only effective, however, if the instrument remains permanently switched on. If the instrument (or the OCXO) is switched off and on again, a retrace takes place [5-4] whereby the oscillator frequency assumes another value.

5.10 Level measurement accuracy

The measurement of signal levels always involves some uncertainty. In the case of level measurements using spectrum analyzers, several components contribute to this uncertainty. Spectrum analyzers are, therefore, factory-calibrated prior to their delivery by recording the individual error components and storing them in the analyzer. These error components are considered in the displayed level so that the accuracy is increased.

Since the analyzer characteristics are also subject to temperature drift and aging, most analyzers feature an internal, temperature-stabilized signal source (43) as well as self-adjustment functions allowing critical error components to be determined during operation and appropriate corrections to be taken.

To ensure minimum level errors, calibration at regular intervals (usually at the manufacturer's) is nevertheless required since even the signal source in the analyzer used for the self-adjustment is subject to certain aging, however small, and parameters such as frequency response can only be checked with the aid of external measurement equipment. A calibration interval for factory calibration is therefore recommended in spectrum analyzer data sheets.

The calibration by the manufacturer is also subject to certain measurement uncertainties that are entered into the calibration results. These uncertainties are stated as level error in spectrum analyzer data sheets. The individual error sources are explained in the following. Systematic measurement errors due to insufficient signal-to-noise ratio are not taken into account. These will be discussed separately and in detail at the end of this chapter.

5.10.1 Error components

Max. uncertainty of level measurement	
at 128 MHz, -30 dBm (RF attenuation 10 dB, RBW 10 kHz, ref. level -20 dBm)	<0.2 dB ($\sigma = 0.07$ dB)
Frequency response	
≤50 kHz	<+0.5/-1.0 dB
50 kHz to 3 GHz	<0.5 dB ($\sigma = 0.17$ dB)
3 GHz to 7 GHz	<2.0 dB ($\sigma = 0.7$ dB)
Frequency response with electronic attenuator switched on	
10 MHz to 3 GHz	<1 dB ($\sigma = 0.33$ dB)
3 GHz to 7 GHz	<2.0 dB ($\sigma = 0.7$ dB)
Attenuator	<0.2 dB ($\sigma = 0.07$ dB)
Reference level switching	<0.2 dB ($\sigma = 0.07$ dB)
Display nonlinearity LOG/LIN (S/N >16 dB)	
RBW ≤100 kHz	
0 dB to -70 dB	<0.2 dB ($\sigma = 0.07$ dB)
-70 dB to -90 dB	<0.5 dB ($\sigma = 0.17$ dB)
RBW ≥300 kHz	
0 dB to -50 dB	<0.2 dB ($\sigma = 0.07$ dB)
-50 dB to -70 dB	<0.5 dB ($\sigma = 0.17$ dB)
Bandwidth switching uncertainty (ref. to RBW = 10 kHz)	
10 Hz to 100 kHz	<0.1 dB ($\sigma = 0.03$ dB)
300 kHz to 10 MHz	<0.2 dB ($\sigma = 0.07$ dB)
1 Hz to 3 kHz FFT	<0.2 dB ($\sigma = 0.03$ dB)

Fig. 5-25 Typical data sheet specifications for the level measurement error of a spectrum analyzer

Absolute level error

The total gain of the analog signal processing of a spectrum analyzer may vary due to temperature drift or aging. For correction of the resulting level error, a signal can be applied to the input of the analyzer (ahead of the RF attenuator) as shown in the block diagram on the fold-out page. If the level of this signal is known, the actual transfer constant of the analog stages can be determined and the level error due to temperature drift or aging can be compensated. As a prerequisite, the signal level must be constant throughout the temperature range of the analyzer. The stability of the built-in signal source used for the self-adjustment is a determining factor for the absolute accuracy of the analyzer.

For precise level measurements throughout the temperature range, the self-adjustment function is called up after the warmup time specified in the data sheet (often 30 minutes). This function allows the errors described above to be determined and corrected during measurements.

The frequency of the signal used for the self-adjustment is usually constant since the transfer constant of the signal processing stages including the first mixer can only be determined at one frequency. The absolute level error therefore is only valid at this frequency (128 MHz in our example). The measurement uncertainty is increased by the magnitude of the frequency response if the measurement is carried out at another frequency.

Since parameters such as selected IF bandwidth, RF attenuation, IF gain (set via reference level) and linearity of the log amplifier also influence the accuracy, they are specified in conjunction with the absolute level error.

The above data sheet specifications are valid specifically at a level of -30 dBm (corresponding to the level of the calibration source), 10 dB RF attenuation, -20 dBm reference level and 10 kHz resolution bandwidth.

Frequency response

Errors due to the frequency response are entered into the total measurement uncertainty if level measurements are not carried out at the frequency of the signal source used for self-adjustment (128 MHz in our example).

For frequency ranges in which a YIG filter is switched in the signal path of the analyzer (above 3 GHz in our example), additional conditions often have to be met to attain the specified values. Due to their magnetic circuit, YIG filters exhibit a certain inertia as well as some temperature drift of the center frequency. Therefore, it is not always possible to measure exactly at the same point of the transfer function. For example, the insertion loss of the filter may vary due to passband ripple.

A peaking function is therefore often provided in spectrum analyzers. If a signal is applied to the analyzer input, this peaking function can be used for fine adjustment of the center frequency to the maximum signal level which results in higher level accuracy.

During this fine adjustment process, the YIG filter is tuned in a very small frequency range at a relatively low speed. Due to the dynamic response of YIG filters, measurements are again not carried out exactly at the point determined by fine adjustment, particularly at very high sweep speeds. With very short sweep times (<10 ms/GHz in our example) an additional error is produced.

Linearity error or display nonlinearity

The linearity error provides information about the display linearity. In the ideal case, a variation of the input level by n dB causes a variation of the displayed level by n dB. The linearity error gives the maximum deviation from the expected variation of the displayed level.

With a logarithmic level display, the log amplifier primarily determines this error. Often the maximum error is given for a specific level range referred to the reference level. (Fig. 5-25, such as -0.2 dB for displayed levels that are maximally 70 dB below the reference level with resolution bandwidths ≥ 100 kHz). If the level varies within this range, the displayed level differs from the actual value within the specified error.

It is customary to specify the maximum total linearity error as a function of the displayed level referred to the reference level.

For example, the maximum linearity error for the level range 0 dB to 70 dB below the reference level is $0.3 \text{ dB} + 0.01 \cdot (\text{offset from reference level})$. Accordingly, the display error of a signal with a display level 70 dB below the reference level is $0.3 \text{ dB} + 0.01 \cdot 70 \text{ dB} = 1 \text{ dB}$.

The level error specified in this way is especially relevant for absolute level measurements. For relative level measurements, the deviation of the displayed level variation from the expected level variation is of interest and has to be specified as an arithmetic sum. It is usually stated as maximum error for a specific level variation. For instance, $0.4 \text{ dB}/4 \text{ dB} = 0.4 \text{ dB}$ deviation for a level variation by 4 dB.

For the linear display mode, the linearity error is stated as a percentage relative to the reference level.

Attenuator error

Attenuator settings are subject to errors. In modern instruments, this error is determined during the self-adjustment procedure and the displayed level is corrected accordingly. The value specified for the attenuator error is regarded as a residual error due to long-term effects such as drift due to temperature variations.

IF gain error or error of reference level setting

Similar to the attenuator setting, the IF gain setting is also subject to errors. Since the IF gain can be set only indirectly via the reference level, the error is also referred to as reference level setting error. In addition to the specification of the maximum error, as in Fig. 5-25, the error is often specified as a function of the set reference level.

For example, the maximum reference level setting error for a reference level of -20 dBm is 0.3 dB . For other reference levels the error is $0.3 \text{ dB} + 0.01 \cdot (\text{deviation from a reference level of } -20 \text{ dBm})$. If the reference level is set to $+10 \text{ dBm}$, the maximum reference level setting error is $0.3 \text{ dB} + 0.01 \cdot (+10 \text{ dBm} - (-20 \text{ dBm})) = 0.6 \text{ dB}$.

Bandwidth switching error

When switching between different resolution bandwidths, level uncertainties occur that have to be taken into account. Similar to the attenuator error or IF gain error, this uncertainty can be determined during the self-adjustment procedure and compensated by a correction factor. The specified error corresponds to the residual uncertainty due to long-term effects such as temperature drift.

Effect of bandwidth errors

Bandwidth errors are understood as the deviation of the actual from the set resolution bandwidth. A specified bandwidth error of 5% means that with a set resolution bandwidth of 10 kHz, for example, the actual bandwidth may be anywhere between 9.5 kHz and 10.5 kHz. This error is only significant for applications in which the measured power has to be referred to the measurement bandwidth or the measurement bandwidth must be known for further calculations. This is, for instance, the case with phase noise measurements or channel power measurements (chapter 6.3).

The resulting level error can in turn be calculated from the bandwidth error as a percentage. The following holds true for noise or noise-like signals:

$$\Delta L_{RBW} / dB = 10 \cdot \log \left\{ 1 - \left(\frac{\Delta_{RBW} / \%}{100} \right) \right\} \quad \text{(Equation 5-43)}$$

where ΔL_{RBW} = level error due to bandwidth error
 Δ_{RBW} = bandwidth error

Error due to mismatch

An ideal spectrum analyzer with an input reflection coefficient of zero would absorb the applied input power completely irrespective of the output impedance of the signal source.

However, the reflection coefficient at the input of a real spectrum analyzers is > 0 , so that there is a mismatch. The measurement result, therefore, depends on the output reflection coefficient of the source which is typically > 0 . The measurement uncertainty M_U due to mismatch is given by:

$$M_U = 100 \cdot \{(1 \pm r_s \cdot r_l)^2 - 1\} \quad \text{(Equation 5-44)}$$

where M_U = measurement uncertainty, in %
 r_s = magnitude of source reflection coefficient
 r_l = magnitude of spectrum analyzer reflection coefficient

The following approximation applies:

$$M_U \approx \pm 200 \cdot r_s \cdot r_l \quad \text{(Equation 5-45)}$$

In contrast to power meters, level errors are stated in dB for spectrum analyzers. Equation 5-44 can be expressed as

$$\Delta L_r = 20 \cdot \log(1 - r_s \cdot r_l) \quad \text{(Equation 5-46)}$$

where ΔL_r = level error due to mismatch, in dB

The input matching of an analyzer or output matching of a DUT is often stated as voltage standing wave ratio (VSWR) or return loss. Based on such data, the corresponding reflection coefficients can be calculated as follows:

$$r = \frac{s - 1}{s + 1} \quad \text{(Equation 5-47)}$$

where r = reflection coefficient
 s = VSWR

and

$$r = 10^{-\frac{a_r}{20}}$$

where a_r = return loss, in dB

Substituting Equation 5-47 in Equation 5-46 yields

$$\Delta L_r = 20 \cdot \log \left(1 - \frac{s_s - 1}{s_s + 1} \cdot \frac{s_l - 1}{s_l + 1} \right) \quad \text{(Equation 5-48)}$$

Improvement of input matching

The RF attenuation of a spectrum analyzer should always be set to at least 10 dB provided that the sensitivity is sufficiently high. In this way the first mixer is protected against damage by too high input signals and the input matching is improved. For example, if an ideal attenuator pad with an attenuation $a = 6$ dB is connected ahead of a twoport with a return loss of $a_r = 10$ dB at the input, the total return loss $a_{r,\text{total}}$ is $a_r + 2 \cdot a$ or 22 dB. Fig. 5-26 shows the spectrum analyzer with the attenuator pad.

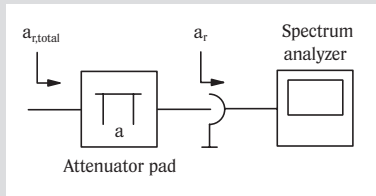

Fig. 5-26 Improvement of spectrum analyzer input matching by connecting an attenuator pad ahead of analyzer

The return loss of real attenuator pads, including the attenuator of a spectrum analyzer, is limited, so the theoretical values cannot be attained under certain conditions. The input matching of an attenuator is usually much better than that of the broadband first mixer. Especially for measurements on DUTs with poor output matching, the level measurement accuracy can be dramatically increased with an attenuator setting of ≥ 10 dB.

In spectrum analyzers, the RF attenuation can usually be coupled to the reference level. In this coupled mode, the minimum RF attenuation, 10 dB, is therefore set for the above reason even for very low reference levels.

5.10.2 Calculation of total measurement uncertainty

Error sources contributing to the total measurement uncertainty depend on the type of measurement. In the following sections, error sources encountered in frequency measurement applications are described.

Measurement of absolute level

If the absolute level of a sinusoidal signal is to be measured, the following factors usually contribute to the total measurement uncertainty:

- Absolute level error
- Frequency response
(only if the signal frequency distinctly differs from the frequency of the internal calibration source)
- Attenuator error
(only if the attenuator setting differs from that specified in the data sheet for the absolute error)
- IF gain error
(only if the set reference level differs from that specified in the data sheet for the absolute error)
- Linearity error
The linearity error to be taken into account depends on the spacing of the input signal from the reference level.
- Bandwidth switching error
(only if the set bandwidth differs from that specified in the data sheet for the absolute error)

An additional bandwidth error has to be taken into account in noise or channel power measurements.

Relative level measurement

The following error contributions have to be taken into account when measuring the level difference between two sinusoidal signals.

- Frequency response
(only if the signal frequency strongly varies between the individual measurements)
- Attenuator error
If the attenuator setting is not varied during measurement, this error can be ignored.
- IF gain error
If the reference level is not varied during measurement, this error can be ignored.
- Linearity error
- Bandwidth switching error
If the bandwidth is not varied during measurement, this error can be ignored.

An additional bandwidth error has to be taken into account in noise or channel power measurements if the resolution bandwidth is varied between the measurements.

Resolution bandwidth, attenuator setting (RF attenuation) and reference level should not be varied during the measurement in order to minimize the error of relative level measurement. Only the linearity error and frequency response, if applicable, will then contribute to the total measurement uncertainty.

Table 5-2 shows the error contributions that have to be considered in a number of typical measurements. The maximum error (worst case error) can be calculated from the individual contributions simply by adding the relevant parameters. The calculated maximum error has a confidence level of 100% so that the actual error of a measurement never exceeds the calculated error limits.

In practice, however, the maximum error seldom occurs. If the total uncertainty is the sum of many individual errors stemming from completely independent sources, it is statistically a very rare event that all individual errors occur in a measurement simultaneously at their maximum value and same sign.

Measurement	Absolute level of CW signal	Harmonic distortion	3rd order intermodulation products (close to carrier)	3rd order intercept	Channel power	Adjacent-channel power ratio	Power versus time (e.g. for TDMA signals), relative	Phase noise, far off carrier, with variation of RF attenuation and reference level	Phase noise, close to carrier
Error contribution									
Absolute error	•			•	•				
Frequency response	•	•		•	•				
Attenuator error	•			•	•			•	
IF gain error	•			•	•			•	
Linearity error	•	•	•	•	•	•	•	•	•
Bandwidth switching error	•			•	•				
Bandwidth error					•	•		•	•
Error due to limited number of samples					•	•			
Mismatch error	•	•		•	•				

Table 5-2 Error contributions in typical measurements using a spectrum analyzer

It is more realistic to calculate the total uncertainty with a certain confidence level, which is typically 95% or 99%. Such calculation is permissible if the total uncertainty is composed of several error contributions of equal magnitude.

The distribution of the individual error contributions depends on the type of error. The following discussions are based on [5-5].

For random errors, that is for all errors listed above with the exception of mismatch errors, a rectangular distribution is assumed. The variance σ^2 of the individual errors is given by:

$$\sigma^2 = \frac{a^2}{3} \tag{Equation 5-49}$$

where σ^2 = variance
 a = max. systematic error, in dB

If the data sheet specification of the level error is not given as worst case but with a certain confidence level, the variance has to be calculated from this value first. The following applies:

$$\sigma^2 = \left(\frac{a_{CL}}{k}\right)^2 \tag{Equation 5-50}$$

where σ^2 = variance
 a_{CL} = specified error with certain confidence level or standard uncertainty, in dB

The value of k depends on the confidence level of the value specified in the data sheet. The following applies:

$$k = \sqrt{2} \cdot \operatorname{erfinv} \left(\frac{CL}{100} \right) \tag{Equation 5-51}$$

where erfinv = inverse error function
 CL = confidence level, in %

Fig. 5-27 shows k as a function of the confidence level. For a confidence level of 95%, k assumes a value of 1.96, and for 99%, a value of 2.58.

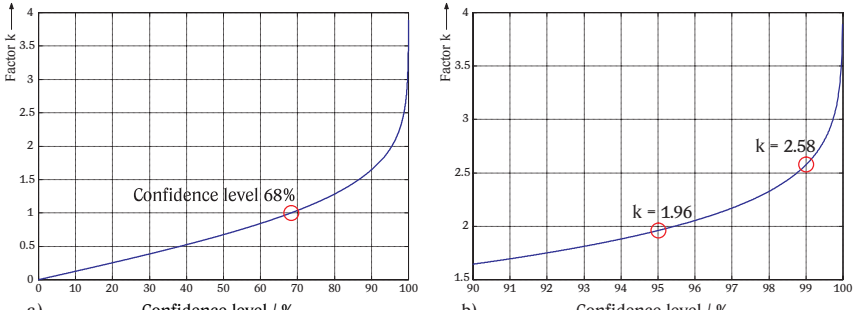

Fig. 5-27 Coverage factor *k* as a function of confidence level
 a) confidence level 0% to 100%, b) confidence level 90% to 100% (zoomed)

In some cases the standard uncertainty *s* is specified in addition to the level error. This makes the calculation according to equation 5-50 unnecessary. The variance can be calculated from the specified standard uncertainty simply by squaring it.

Bandwidth errors are usually specified as a percentage. The following applies:

$$\sigma^2 = \frac{\left\{10 \cdot \log \left(1 + \frac{\Delta_{\text{RBW}}}{100}\right)\right\}^2}{3} \tag{Equation 5-52}$$

where σ^2 = variance
 Δ_{RBW} = bandwidth error, in %

Errors due to mismatch have a U-shape distribution. The variance σ^2 is given by

$$\sigma^2 = \frac{\left\{20 \cdot \log(1 - r_s \cdot r_l)\right\}^2}{2} = \frac{\left\{20 \cdot \log\left(1 - \frac{s_s - 1}{s_s + 1} \cdot \frac{s_l - 1}{s_l + 1}\right)\right\}^2}{2} \tag{Equation 5-53}$$

where σ^2 = variance
 r_s = magnitude of source reflection coefficient
 r_l = magnitude of spectrum analyzer reflection coefficient
 s_s = VSWR of source
 s_l = VSWR of spectrum analyzer

The reflection coefficient can be calculated from Equation 5-47.

Error	Calculation of variance	
Absolute level error	$\sigma^2 = \frac{a^2}{3}$ and	<i>Equation 5-49 and Equation 5-50</i>
Frequency response		
Attenuator error		
IF gain error		
Linearity error		
Bandwidth switching error		
Bandwidth error	$\sigma^2 = \frac{\left\{10 \cdot \log\left(1 + \frac{\Delta_{RBW} / \%}{100}\right)\right\}^2}{3}$	<i>Equation 5-52</i>
Mismatch error	$\sigma^2 = \frac{\{20 \cdot \log(1 - r_s \cdot r_l)\}^2}{2}$	<i>Equation 5-53</i>

Table 5-3 Calculating the variance of specified error contributions

The combined standard uncertainty σ_{tot} can be calculated from the variances σ_i^2 of the individual contributions as follows:

$$\sigma_{tot} = \sqrt{\sigma_1^2 + \sigma_2^2 + \dots + \sigma_n^2} \tag{Equation 5-54}$$

It has a confidence level of 68% (Fig. 5-27a). To maintain the error at some other confidence level, σ_{tot} has to be multiplied by a factor k which can be derived from Fig. 5.27. For a confidence level of 95%, k = 1.96 and for 99%, k = 2.58.

Example:

For the absolute level measurement of a sinusoidal input signal of 1 GHz (output VSWR of signal source 1.2:1), the total measurement uncertainty is to be determined with a confidence level of 95%. The resolution bandwidth set on the spectrum analyzer is 30 kHz, the RF attenuation is 20 dB and the reference level 0 dBm. The signal level is about 20 dB below the reference level.

Which errors contribute to the total measurement uncertainty?

- Absolute error
- Frequency response
- Attenuator error
- IF gain error
- Linearity error
- Bandwidth switching error

Since the input is a sinusoidal signal, the bandwidth error does not affect the total measurement uncertainty.

The required data are taken from the spectrum analyzer data sheet:

	Specified error	Variance σ_i^2
Absolute error	0.2 dB	$13.3 \cdot 10^{-3}$
Frequency response	0.5 dB	$83.3 \cdot 10^{-3}$
Attenuator error	0.2 dB	$13.3 \cdot 10^{-3}$
IF gain error	0.2 dB	$13.3 \cdot 10^{-3}$
Linearity error	0.2 dB	$13.3 \cdot 10^{-3}$
Bandwidth switching error	0.1 dB	$3.3 \cdot 10^{-3}$
Mismatch error		
VSWR at spectrum analyzer input	1.5	
VSWR at signal source output	1.2	$12.7 \cdot 10^{-3}$

The combined standard uncertainty can be calculated from the variances σ_i^2 with the aid of Equation 5-54 to yield $\sigma_{tot} = 0.39$. The total measurement error of 0.76 dB is obtained at a confidence level of 95% by multiplying the standard uncertainty by a factor of 1.96.

To simplify such error calculations, a spreadsheet in MS Excel® 5.0 is available (file FSP_ERR.XLS, Fig. 5-28) which can be obtained via the R&S Web site (www.rohde-schwarz.com).

Error Calculation for Rohde & Schwarz Spectrum Analyzers							
Inherent errors	unit	s = stand. uncertainty	specified error	variance σ_i^2	contribute y = yes, n = no		
		w = worst case					
Absolute error 120 MHz	dB	1	2	0.3	0.03	3	4
Frequency response	dB	w	0.2	0.01	0.01	y	
Input attenuator	dB	w	0.2	0.01	0.01	y	
If gain	dB	w	0.2	0.01	0.01	y	
Log linearity	dB	w	0.2	0.01	0.01	y	
Bandwidth switching error	dB	w	0.2	0.01	0.01	y	
Bandwidth error	%		10.00	0.07	0.07	y	
Combined variance		$\sigma_{tot}^2 = \sigma_1^2 + \sigma_2^2 + \dots + \sigma_n^2$		0.17			
Combined standard uncertainty		$\sigma_{tot} = \sqrt{\sigma_{tot}^2}$		0.41			
Total error	(95% confidence level)	dB		0.80			
	(99% confidence level)	dB		1.05			5
Error due to source mismatch		a = return loss / dB v = VSWR		specified values			
VSWR of SA		6	7	3.1			
VSWR of DUT		v	1.57	0.55			
Combined variance		$\sigma_{tot}^2 = \sigma_1^2 + \sigma_2^2 + \dots + \sigma_n^2$		0.71			
Combined standard uncertainty		$\sigma_{tot} = \sqrt{\sigma_{tot}^2}$		0.85			
Error including source mismatch	(95%)	dB		1.66			
	(99%)	dB		2.18			8

Fig. 5-28 Spreadsheet FSP_ERR.XLS

Legend for spreadsheet FSP_ERR.XLS

All input fields in the table are highlighted yellow. The fields for intermediate results and the resulting total level are highlighted in light and dark blue.

- 1 You can choose whether the values entered in (2) are absolute error limits (worst case) or a standard uncertainty.
- 2 Input fields for specified errors.
- 3 Output of the variances calculated from the input values.
- 4 You can choose whether the error entered under (2) is to be taken into account in calculating the total error. Error contributions can thus very easily be ignored without having to set the value entered under (2) to zero.
- 5 Output of the calculated total error with a confidence level of 95% or 99%. Errors due to mismatch are not considered in this result.
- 6 You can choose whether the mismatch of the DUT or spectrum analyzer is entered as VSWR (v) or as return loss (a).
- 7 Input field for specified maximum mismatch of the DUT or spectrum analyzer.
- 8 Output of the calculated total error with a confidence level of 95% or 99%. All error sources are considered in the result.

5.10.3 Error due to low signal-to-noise ratio

The signals displayed on a spectrum analyzer are the sum of the input signal (S) and the superimposed thermal noise (N). If the signal level is high relative to the noise, this has no adverse effect since the resulting level variation due to the superimposed noise referred to the measurement level is low. Level measurements on signals with low signal-to-noise ratio, however, produce errors that are not negligible.

The error can be corrected if the ratio between total signal plus noise power and inherent noise $(S+N)/N$ is known. The thermal noise power without input signal is determined first at the measurement frequency. With the same spectrum analyzer settings, the level of the input signal including the superimposed noise is then measured and the ratio $(S+N)/N$ calculated. As described in the following, a correction factor can be found and subtracted from the measured total power level $(S+N)$ to obtain the true signal level (S). Both the type of input signal and detector used have to be taken into account.

To increase the measurement accuracy, it is necessary to smooth the trace by employing appropriate methods.

RMS detector

When using the RMS detector, the effective value of power is measured in both measurements of the thermal noise power and the input signal level with superimposed noise. As already explained in connection with the sensitivity limit (chapter 5.1), an input signal with a level corresponding to the thermal noise level causes a noise increase by 3 dB. Accordingly, the correction value for $(S+N)/N = 3$ dB is 3 dB. The following applies:

$$c_N = 10 \cdot \log \left(\frac{10^{0.1 \cdot \frac{S+N}{N}}}{10^{0.1 \cdot \frac{S+N}{N}} - 1} \right) \quad \text{(Equation 5-55)}$$

where c_N = correction factor, in dB
 $(S+N)/N$ = measured ratio between total signal power and noise power, in dB

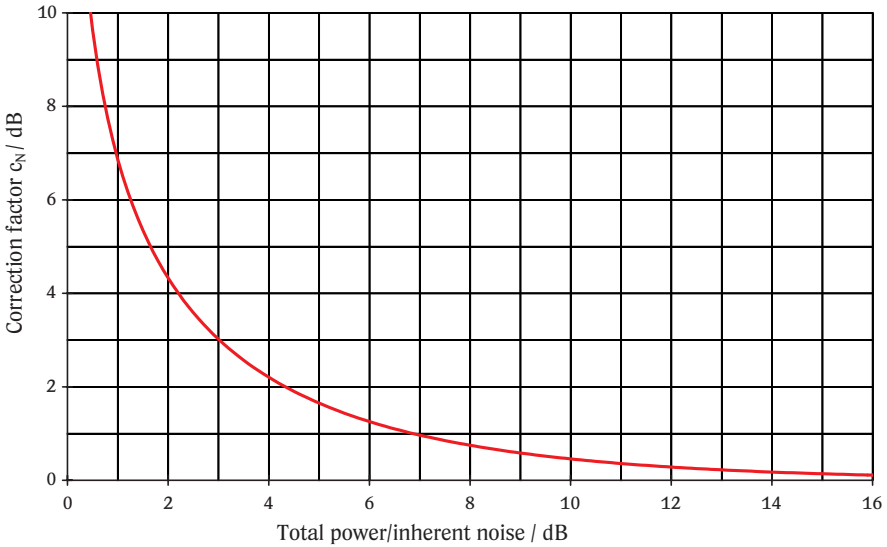

Fig. 5-29 Correction factor c_N as a function of total power/inherent noise $((S+N)/N)$ for measurement of noise or noise-like signals using RMS detector

Example:

The channel power of a digitally modulated signal at a low level is to be measured and the result corrected. A special measurement function of the spectrum analyzer is used to determine the channel power. The channel bandwidth is 4.096 MHz.

Because of the noise-like signal, the RMS detector is used for the measurement.

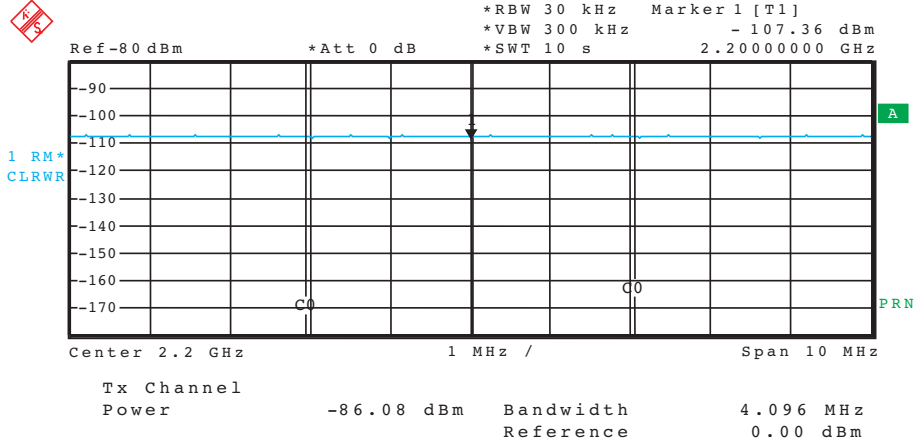
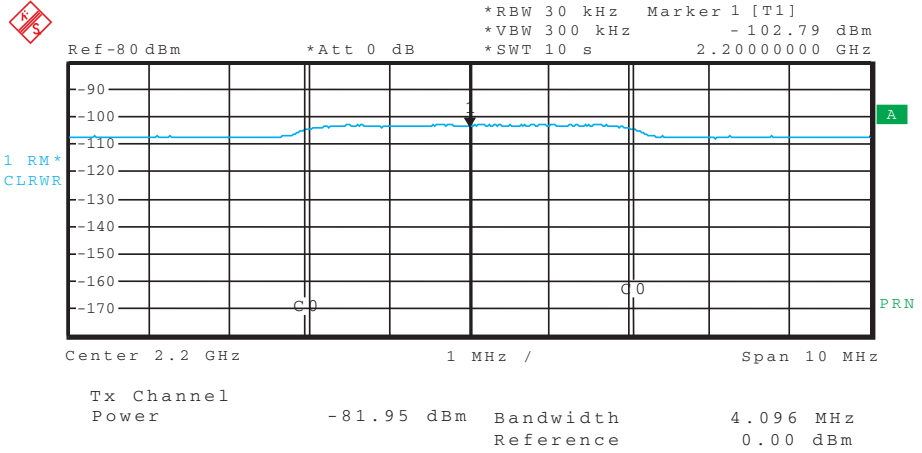

Fig. 5-30 Channel power measurement. Measurement of total power (a) and inherent noise (b)

Step 1: measurement of total power (S+N) in given channel:

$$S+N = -81.95 \text{ dBm} \quad (\text{Fig. 5-30 a})$$

Step 2: measurement of inherent noise (N) in given channel:

$$N = -86.08 \text{ dBm} \quad (\text{Fig. 5-30 b})$$

Step 3: calculation of ratio between total power and inherent noise

$$(S+N)/N:$$

$$(S+N)/N = -81.95 - (-86.08 \text{ dBm}) = 4.13 \text{ dB}$$

Step 4: determination of correction factor (from Equation 5-55 or Fig. 5-29):

$$c_N = 2.2 \text{ dB}$$

Step 5: calculation of signal level from total power level:

$$S = (S+N) - c_N = -81.95 \text{ dBm} - 2.2 \text{ dB} = -84.15 \text{ dBm}$$

Sample detector

The displayed level of noise and noise-like signals is too low if the sample detector is used and averaging over a logarithmic level scale. However, sinusoidal signals are not affected. The correction factor to be applied therefore depends on the type of input signal.

If measurements are carried out on noise signals, the displayed level of both the input signal and the inherent noise is 2.5 dB too low. The resulting ratio between total power and inherent noise corresponds to the result that would be obtained with the RMS detector. The correction factor can be calculated according to Equation 5-55 or derived from Fig. 5-29.

If the input signal is a discrete spectral line, for instance a sinusoidal signal, the measured level is not falsified by the sample detector and averaging over a logarithmic level scale. Since a lower level is displayed for the inherent noise, the ratio between total power and inherent noise is greater than when using the RMS detector. Correction factors calculated according to Equation 5-55 are not valid. It is recommended that the RMS detector is used in such cases.

5.11 Sweep time and update rate

The minimum sweep time, that is the minimum time required for recording a certain frequency span, is determined by various factors.

- Resolution and video bandwidths
- Setting time of LO
- Data processing
- Sampling rate of A/D converter
- Maximum sweep speed of YIG filter, if applicable

The dependency of the sweep time on the resolution and video bandwidths as well as on the span was described in chapter 4.6: Parameter dependencies. As described, the required minimum sweep time increases with decreasing resolution bandwidth so that for such cases the use of FFT filters is recommended provided their use is permitted by the specific measurement application.

But even at very large resolution and video bandwidths, the sweep time cannot be reduced without any limitation. For setting the local oscillator and collecting measured data, a certain minimum time is always required which in turn depends on the set span, so that there is a limit (2.5 ms in our example) that cannot be reduced even under the most favorable circumstances.

In the case of large spans, the minimum sweep time is additionally influenced by the permissible tuning speed of the local oscillator. For the analyzer described here, a sweep time of 5 ms, for instance, is required for a span of 1 GHz. In concepts using tracking YIG filters for image frequency rejection (above 3 GHz for the analyzer described here), the sweep speed is further reduced by the “inertia” of the tunable magnetic circuit. Sweep times of less than 6 ms at 1 GHz span can hardly be attained in such cases.

Data sheets usually specify the minimum sweep time that is achievable under the most favorable conditions, such as large resolution and video bandwidth and small span in a frequency range for which the tracking YIG filter is not required. In our example, 2.5 ms sweep time can be achieved under these circumstances.

If the spectrum analyzer remains tuned to a fixed frequency during the measurements, which is referred to as zero span, the minimum measurement time only depends on the data acquisition of the analyzer. The minimum measurement times achievable in this mode are very short (1 μ s, in our example).

An essential criterion in this mode is the time resolution. That is, the minimum time between two samples (125 ns in our example). The sampling rate of the A/D converter is the limiting parameter in this case.

The update rate (number of sweeps per unit time), is again important both for manual and remote-controlled operation of the spectrum analyzer. Additional time is required for data processing, display and, where applicable, data transfer via the IEEE bus or other interfaces so that the maximum update rate is considerably lower than the reciprocal value of the achievable minimum sweep time (Fig. 5-31).

If FFT filters are used, the difference is especially high due to the very complex calculations.

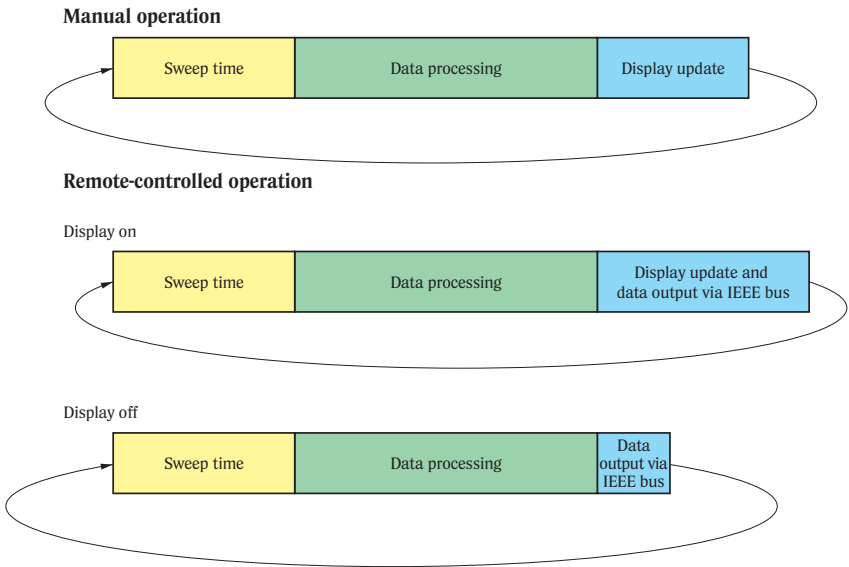

Fig. 5-31 Sequence of a measurement

A high screen update rate is desirable in the manual mode, such as for tuning operations so that changes in the recorded spectrum are displayed almost immediately. Update rates of about 20 measurements per second are sufficient for such applications as they yield almost flicker-free display. For automated measurements, such as in production, where control commands and measurement results are transferred via interfaces like the IEEE bus, the update rate can never be high enough to achieve minimum test times and high production throughput.

As shown in Fig. 5-31, a certain time for displaying the results on the screen is required in remote-controlled mode. To achieve maximum update rates it is therefore advisable to deactivate the screen display.

6 FREQUENT MEASUREMENTS AND ENHANCED FUNCTIONALITY

6.1 Phase noise measurements

As described in chapter 5.3, the phase noise of an oscillator is a measure of the oscillator’s short-term stability and hence an essential quality criterion. Therefore, special phase noise measurement equipment or, when requirements on the dynamic range are not stringent, spectrum analyzers are used for phase noise measurement.

Phase noise measurement with a spectrum analyzer is referred to as a direct measurement. As a prerequisite, the DUT must have a small frequency drift relative to the sweep time of the spectrum analyzer or else the measurable frequency variation of the oscillator would be too large and invalidate the measurement results. Spectrum analyzers are therefore mainly suitable for measurements on synthesized signal sources locked to a stable reference rather than for measurements on free-running oscillators.

6.1.1 Measurement procedure

For oscillators, the SSB phase noise is usually specified at a certain carrier offset referred to the carrier level within 1 Hz bandwidth (Fig. 6-1). Accordingly, the unit is dBc (1 Hz).

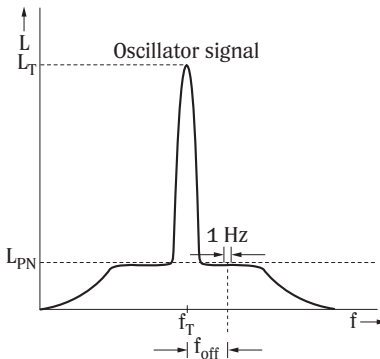

Fig. 6-1 Definition of SSB phase noise

Phase noise measurement with a spectrum analyzer requires two steps:

- Measurement of carrier level L_c
- Measurement of phase noise level L_{PN} at carrier offset f_{off}

For evaluation, the phase noise measured at a carrier offset f_{off} and resolution bandwidth B_{IF} is first referred to a 1 Hz bandwidth. The following applies when using the RMS detector:

$$L_{PN}(f_{off}) = L_{PN,meas}(f_{off}) - 10 \cdot \log B_{N,IF} \quad \text{(Equation 6-1)}$$

- where
- $L_{PN}(f_{off})$ = phase noise level at carrier offset f_{off} referred to 1 Hz bandwidth, in dBm
 - $L_{PN,meas}(f_{off})$ = phase noise level measured with RMS detector at noise bandwidth $B_{N,IF}$ in dBm
 - $B_{N,IF}$ = noise bandwidth of resolution filter, in Hz

Depending on the filter implementation, the noise bandwidth of the resolution filter can be calculated from the 3 dB filter bandwidth with the aid of the conversion factors given in Table 4-1. If the sample detector is used instead of the RMS detector and the trace averaged over a narrow video bandwidth or over several measurements, the noise will be underweighted as described in chapter 4.4: Detectors. The following then applies:

$$L_{PN}(f_{off}) = L_{PN,meas}(f_{off}) - 10 \cdot \log B_{N,IF} + 2.5 \text{ dB} \quad \text{(Equation 6-2)}$$

- where
- $L_{PN,meas}(f_{off})$ = averaged phase noise level measured with sample detector at noise bandwidth $B_{N,IF}$ in dBm

The phase noise level within 1 Hz bandwidth is now referred to the carrier level:

$$L(f_{off}) = L_{PN}(f_{off}) - L_c \quad \text{(Equation 6-3)}$$

- where $L(f_{\text{off}})$ = relative phase noise level within 1 Hz bandwidth at carrier offset f_{off} referred to carrier level, in dBc (1 Hz)
- $L_{\text{PN}}(f_{\text{off}})$ = phase noise level within 1 Hz bandwidth at carrier offset f_{off} , in dBm
- L_{C} = carrier level, in dBm

To simplify phase noise measurements, most spectrum analyzers feature marker functions which allow direct readout of the phase noise at a given carrier offset. Usually, noise bandwidth and correction factors, which are necessary due to the underweighting of noise signals when using the sample detector, are already taken into account.

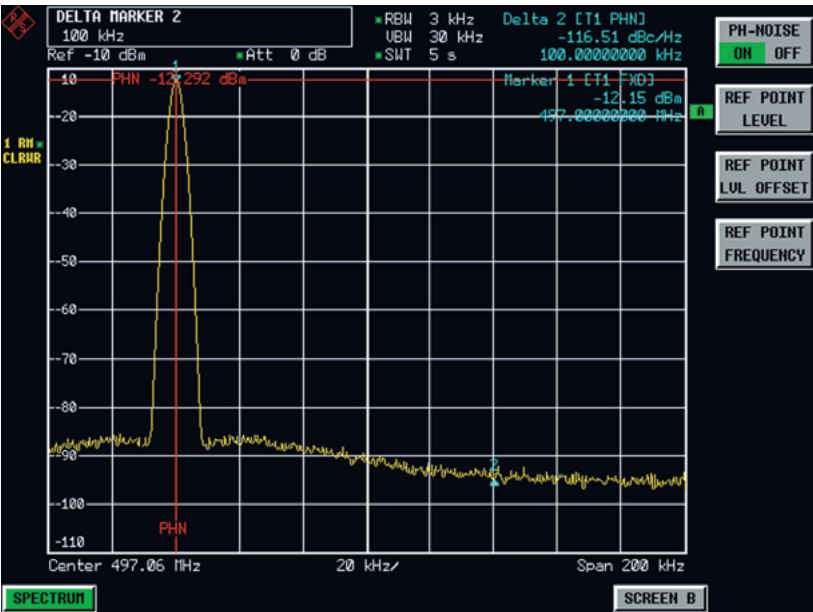

Fig. 6-2 Marker function for easy phase noise measurement

With such marker functions the phase noise can only be determined at a certain carrier offset. However, the phase noise is often of interest in a wider range (such as 1 kHz to 1 MHz carrier offset). To make these measurements simple, application software is available for some spectrum analyzers. Fig. 6-3 shows the result of a phase noise measurement using this kind of software.

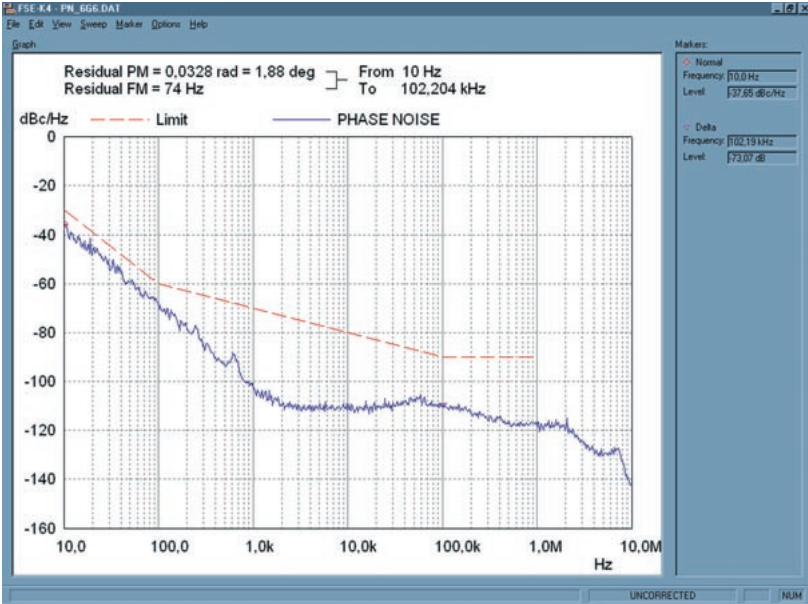
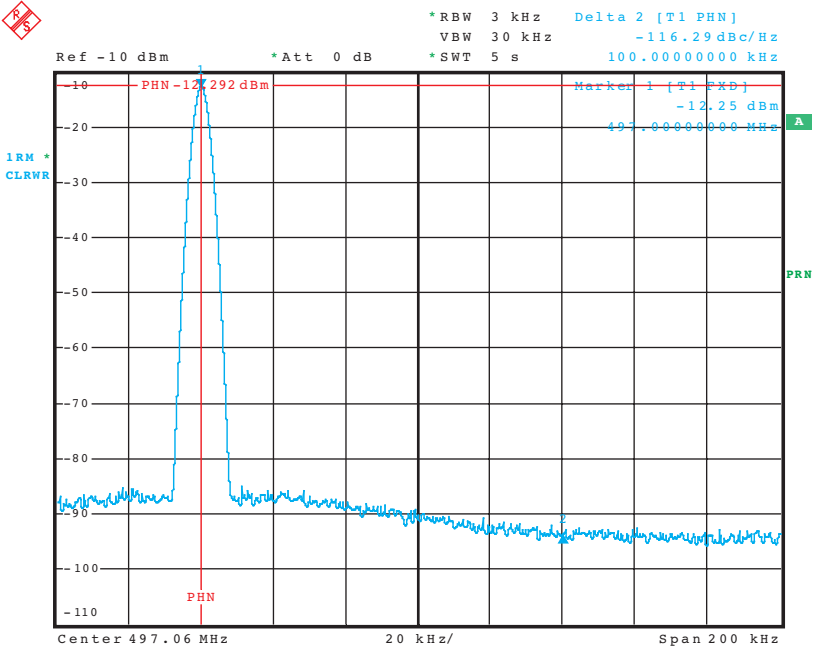

Fig. 6-3 Phase noise measurement over wide offset range

6.1.2 Selection of resolution bandwidth

When measuring the phase noise at a certain carrier offset, care should be taken that the selected resolution bandwidth be appropriately small. If the resolution bandwidth is too large, the carrier at the offset f_{off} will not be sufficiently suppressed by the IF filter (Fig. 6-4a). The level of the residual carrier at the input of the envelope detector or A/D converter will be greater than the phase noise and thus the measurement result will be falsified. The phase noise will have an apparently higher value than it should (Fig. 6-4b). The maximum permissible resolution bandwidth depends on the carrier offset and skirt selectivity (the shape factor of the IF filter). A generally valid relationship principle, therefore, cannot be established.



a)

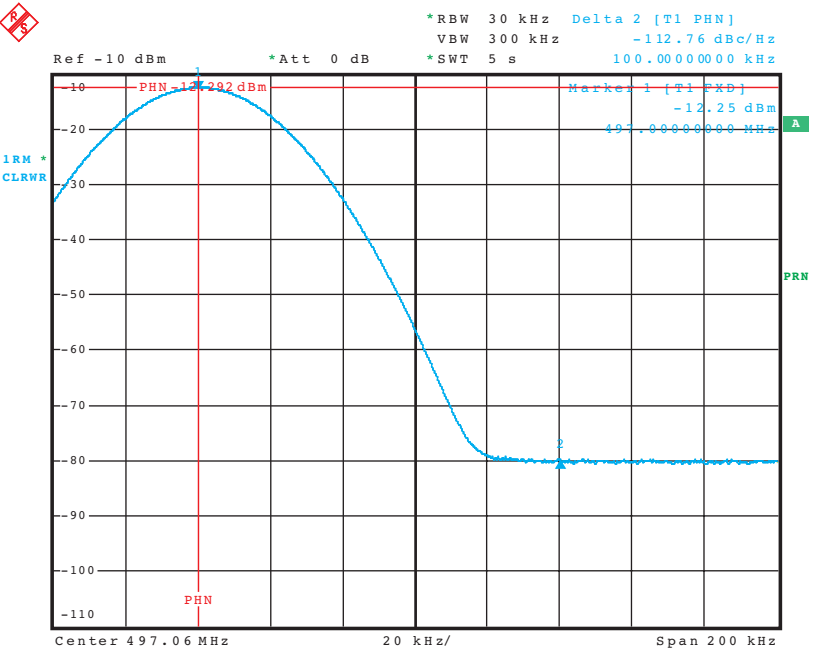

b)

Fig. 6-4 Choosing the right resolution bandwidth: (a) resolution bandwidth too large, carrier suppression is insufficient; (b) resolution bandwidth is small enough

Due to the high minimum sweep times at narrow IF bandwidths, high resolution bandwidths are desirable in practice. With a wideband IF filter, the resolution bandwidth should be reduced in steps until the measured phase noise values no longer decrease.

6.1.3 Dynamic range

The phase noise of the local oscillators is transferred to the converted input signal by reciprocal mixing in the converting stages of the spectrum analyzer (chapter 5.3: Phase noise). If the input signal is of sufficiently high level so that the effects of thermal noise of the spectrum analyzer are negligible, the achievable dynamic range at small carrier offsets is solely determined by the LO phase noise of the analyzer. The limitation imposed by the system-inherent phase noise is independent of the input signal level.

Since it is always the sum of the DUT phase noise and LO phase noise of the spectrum analyzer that is measured, such measurement can only be carried out on DUTs with relatively high phase noise.

As shown in Fig. 5-11, the system-inherent phase noise of spectrum analyzers decreases with increasing carrier offset. At large carrier offsets the dynamic range is limited to an increasing extent by the thermal noise of the spectrum analyzer. There is no clear-cut difference between limitation due to system-inherent phase noise and thermal noise.

To minimize the limitation caused by thermal noise, a high signal-to-noise ratio is required via a high signal level at the input of the first mixer. A high 1 dB compression point is also important to achieve a wide dynamic range far off the carrier.

Due to the high signal level, harmonics of the input signal are produced in the first mixer. If the maximum offset up to which phase noise is to be examined is smaller than the input frequency, the harmonics are outside the frequency range of interest and do not cause any disturbance.

If the input signal level is greater than the dynamic range of the spectrum analyzer, it has to be reduced by setting a suitable RF attenuation. Due to the attenuator step sizes, the maximum dynamic range may not be fully utilized.

Example:

The 1 dB compression point of the spectrum analyzer is assumed to be +10 dBm (mixer level). To avoid measurement errors, the signal level at the first mixer should not exceed +5 dBm. The RF attenuation can be set in 10 dB steps.

A signal level of +17 dBm is applied to the analyzer input, so an RF attenuation of at least 20 dB is required. The signal level at the first mixer is then -3 dBm. The dynamic range for measurements at large carrier offsets is thus 8 dB lower than the maximum achievable dynamic range.

To utilize the maximum dynamic range, the signal level in our example would have to be attenuated to +15 dBm using an external 2 dB attenuator pad. With 10 dB RF attenuation, a mixer level of +5 dBm is then obtained.

To avoid distortion products due to overdriving, the maximum reference level settable at an RF attenuation of 0 dB is clearly below the upper limit of the analyzer's dynamic range (+5 dBm in the above example). With the analyzer driven to its maximum input, measurement of the carrier level as a subsequent reference for the phase noise would not be possible. Likewise, measurement of phase noise close to the carrier would not be possible. Phase noise is therefore measured in two steps:

1. Measurement of carrier level and phase noise close to carrier

The RF attenuation of the spectrum analyzer is increased until the reference level is equal to the signal level (Fig. 6-5). The carrier level can then be readily measured with the aid of markers, since the input signal does not exceed the reference level. To be able to refer the measured phase noise to the carrier level, the latter is stored. The carrier level is usually stored automatically when activating the marker function for the phase noise measurement.

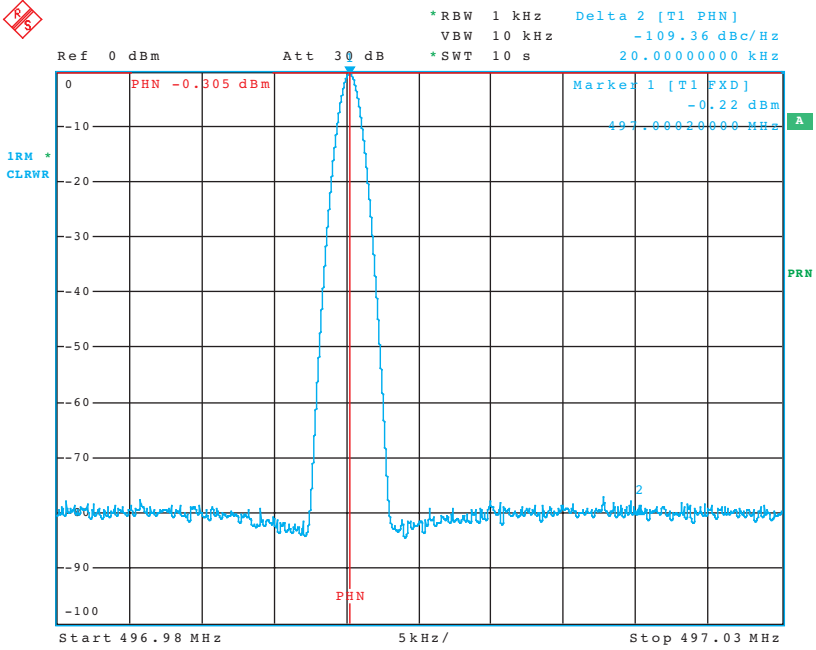

Fig. 6-5 Setting RF attenuation and reference level for measurement of carrier level and phase noise close to carrier

2. Measurement of phase noise far off carrier

The RF attenuation is reduced until the maximum dynamic range limit is attained with the signal applied to the input of the first mixer. The following applies:

$$a_{RF, min} = L_{in} - L_{max} \quad \text{(Equation 6-4)}$$

where

- $a_{RF, min}$ = required minimum RF attenuation, in dB
- L_{in} = signal level at spectrum analyzer input, in dBm
- L_{max} = maximum dynamic range limit of analyzer, in dBm

An overload detector before the first mixer is useful for determining the minimum RF attenuation. The RF attenuation can then be increased until overdriving is no longer detected.

If digital filters are used, deliberately exceeding the reference level may result in overdriving of the A/D converter, which in turn produces unwanted products in the displayed spectrum (chapter 4.6.3: Overdriving). This constraint is not significant, since measurements at large carrier offsets use relatively wideband analog resolution filters.

If digital filters are used and the input signal exceeds the reference level, it has to be ensured that the carrier frequency is far from the displayed spectrum. The carrier is then suppressed by the analog anti-aliasing filter ahead of the A/D converter so that it cannot cause overdriving.

It is very easy to determine whether the noise displayed is the phase noise or the thermal noise of the analyzer. To perform this test, the recorded trace has to be stored and a second measurement carried out with the same settings, but without input signal at the analyzer. If at the carrier offset of interest there is a clear level difference between the two traces as shown in Fig. 6-6a, the measurement result is barely affected by the thermal noise of the analyzer.

In the measurement shown in Fig. 6-6b, the dynamic range is limited by the thermal noise and the result falsified.

The displayed phase noise is always the sum of the phase noise of the DUT and the spectrum analyzer and the spectrum analyzer's thermal noise. If measurements are carried out very close to the dynamic range limit, errors may be produced due to insufficient spacing between the measured phase noise and the system-inherent noise. If the system-inherent noise is known, a correction can be made according to Equation 5-55 (chapter 5.10.3).

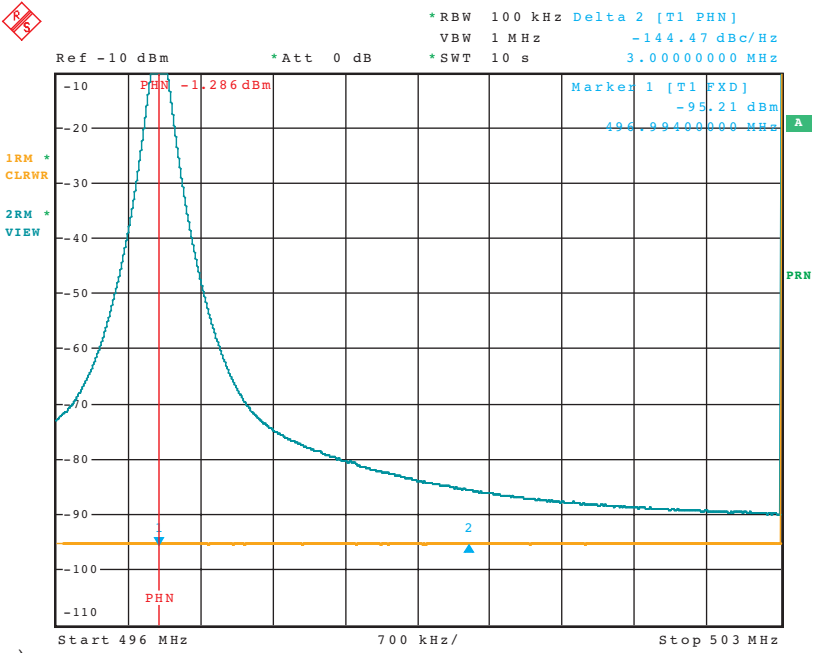

a)

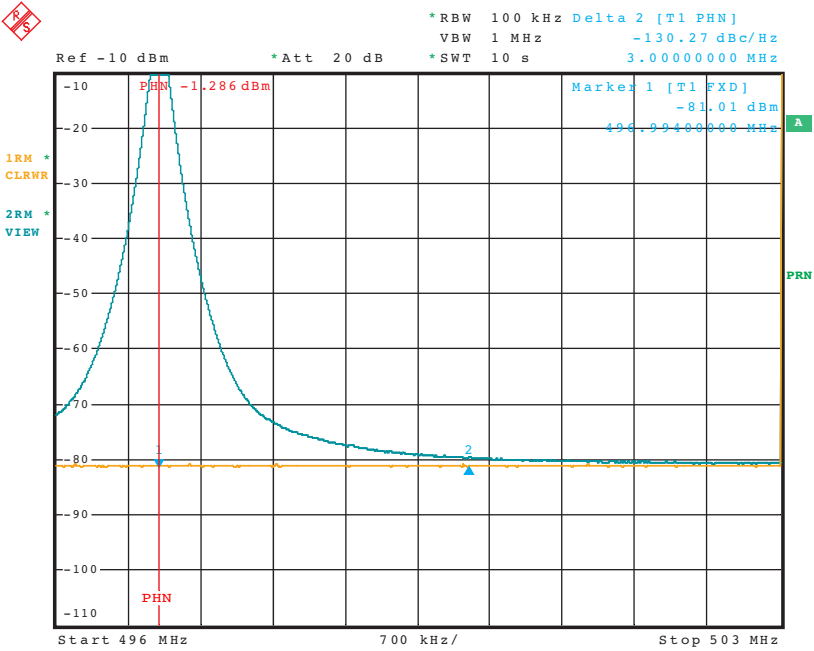

b)

Fig. 6-6 Verification of phase noise measurements.

- (a) Measurement is not not affected by thermal noise of the analyzer.
- (b) Dynamic range is limited by thermal noise of the spectrum analyzer

6.2 Measurements on pulsed signals

(Dipl.-Ing. Volker Janssen)

Communications systems for information transfer, which for a long time have mainly been implemented in analog form, are increasingly being replaced by digital components and systems. The latter often use pulse-modulated signals, for instance in television, radar and mobile radio. Due to the spectral distribution of such signals, a spectrum analyzer used to measure the signals has to fulfil special requirements. The same applies to other types of signals, namely high-frequency, broadband interfering signals occurring in switching operations or in the clock generation of microprocessors. Almost any electronic circuit does not only produce the wanted signals but also unwanted spurious emissions that impair the function of the circuit itself or of other electronic components. Inherent spurious emissions of electronic communications equipment degrade, for instance, specifications like the signal-to-noise ratio (S/N) or bit error rate (BER). The situation can be even worse if conducted or radiated interference affects other devices and impairs their performance or causes malfunction. The prevention of spurious emissions and the provision of high immunity to interference are the domain of electromagnetic compatibility (EMC). Worldwide uniform EMC standards and guidelines provide for reproducibility of interference measurements and form the basis of international regulations with respect to interference limit values to be complied with to ensure proper functioning of electronic units, modules, devices and systems.

Theoretically, the energy of pulse-modulated signals is distributed over the whole spectrum. The measured energy strongly depends on the resolution bandwidth and on the point of measurement in the spectrum. If the signal is measured close to a null in the envelope, overdriving of the input stage may be caused as a result of incorrect setting. The total energy spectrum is applied to the input stage if no preselection filters are used. This reduces the spectrum and applies the spectrum to the mixer of the first conversion stage in 'slices'. Modern spectrum analyzers feature low nonlinearities and high overload capacity (high intercept points of 2nd and 3rd order and high 1 dB compression). Moreover, they are equipped with internal overload detectors used for automatic correction of the analyzer settings in order to optimize the dynamic range and shift it into a non-critical level range with the aid of automatic RF attenuation settings (auto

range function). This ensures ease-of-operation for the user and reliable measurement.

6.2.1 Fundamentals

The description of pulse signals is based on an ideal, periodic rectangular pulse sequence. The general real Fourier representation gives for the time-dependent voltage characteristic $v(t)$:

$$v(t) = \hat{U} \frac{\tau}{T} \left[1 + 2 \sum_{n=1}^{\infty} \frac{1}{\frac{2n\pi\tau}{T}} \cdot \left\{ \sin \frac{2n\pi\tau}{T} \cos n\omega_1 t + \left(1 - \cos \frac{2n\pi\tau}{T} \right) \sin n\omega_1 t \right\} \right]$$

(Equation 6-5)

- where
- \hat{U} = amplitude
 - $v(t)$ = time function
 - τ = pulse duration (width)
 - T = period
 - ω_1 = angular frequency
 - n = order of harmonic oscillation

The coefficients of the Fourier series describe the spectral amplitudes as

$$V_n = 2\hat{U} \frac{\tau}{T} \frac{\sin \frac{n\pi\tau}{T}}{\frac{n\pi\tau}{T}} \tag{Equation 6-6}$$

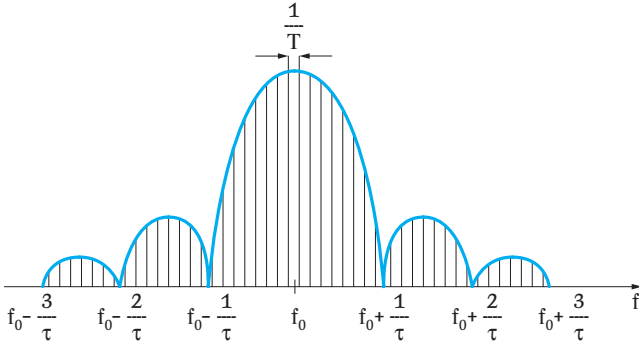

Fig. 6-7 General spectral display (si function) after Fourier analysis with modulated carrier frequency f_0

While the Fourier representation furnishes contributions from $-\infty$ to $+\infty$ and the coefficients may also have a negative sign (Fig. 6-1), the spectrum analyzer only represents positive frequencies according to their magnitude. Two pulse sequence characteristics according to Fig. 6-8 are obtained:

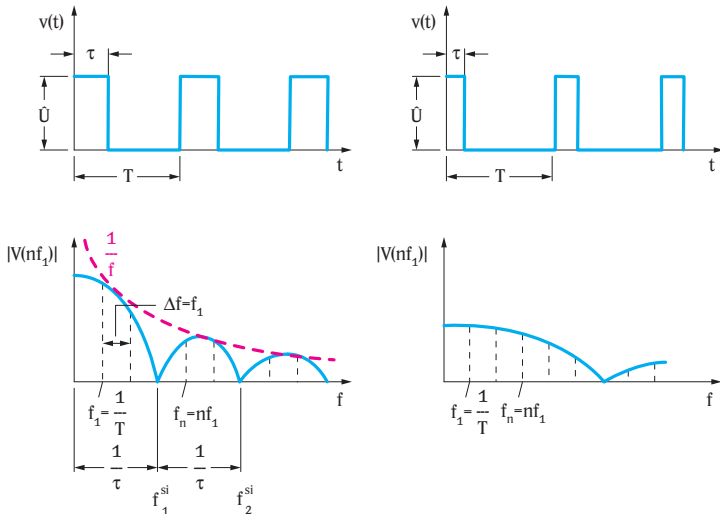

Fig. 6-8 Line spectra of two rectangular voltage characteristics with different mark-to-space ratio, shown in time domain and in frequency domain. The envelope of the spectral line is an si function decaying proportional to $1/f$

The smallest frequency f_1 is the fundamental, corresponding to the reciprocal value of the period T:

$$f_1 = 1/T \tag{Equation 6-7}$$

The amplitude values of the harmonics according to Equation 6-6 occur at intervals of $\Delta f = f_1 = 1/T$.

The first null of the si function occurs at the reciprocal value of the pulse duration:

$$f_{si1} = 1/\tau \tag{Equation 6-8}$$

Further nulls follow at $f_n = n \cdot f_{si1}$ intervals.

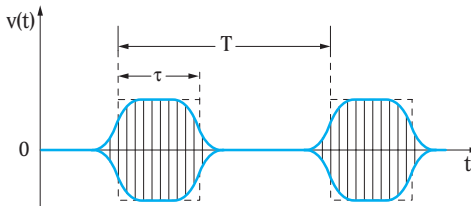

Fig. 6-9 Finite pulse time constants with real pulse signal

The nulls in the pulse spectra measured in practice are not always distinct, because they are somewhat blurred. The reason lies in the asymmetries of real signals that cannot be avoided, since in contrast to the theoretical ideal rectangular pulses, the finite exponential rise and fall times of the real pulses have to be taken into account.

Before dealing with the different terms and the dependencies of the displayed spectrum on the measurement bandwidth, let us examine some other pulse shapes, as well.

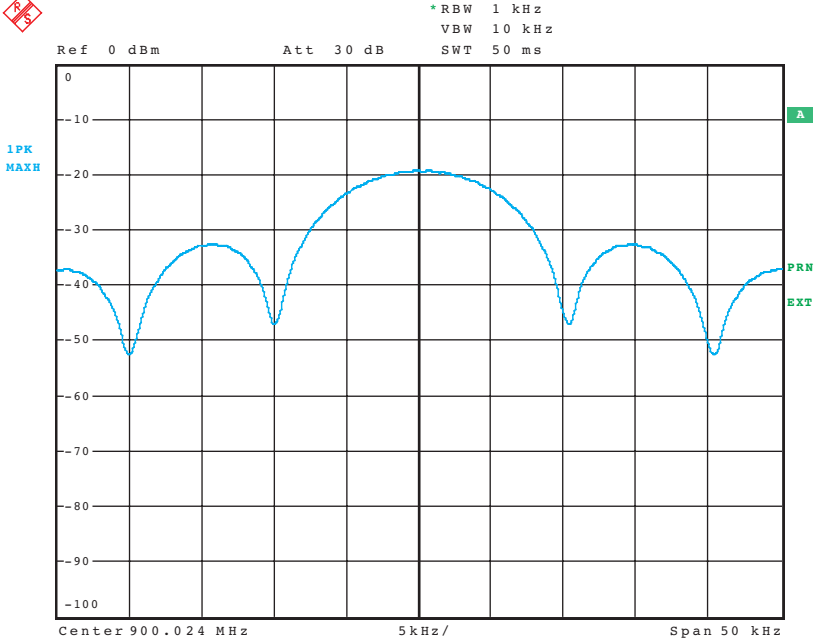

Fig. 6-10 Real representation of envelope spectrum with a spectrum analyzer
(100 μ s pulse duration, 1 ms pulse period,
900 MHz carrier frequency, 1 kHz measurement bandwidth)

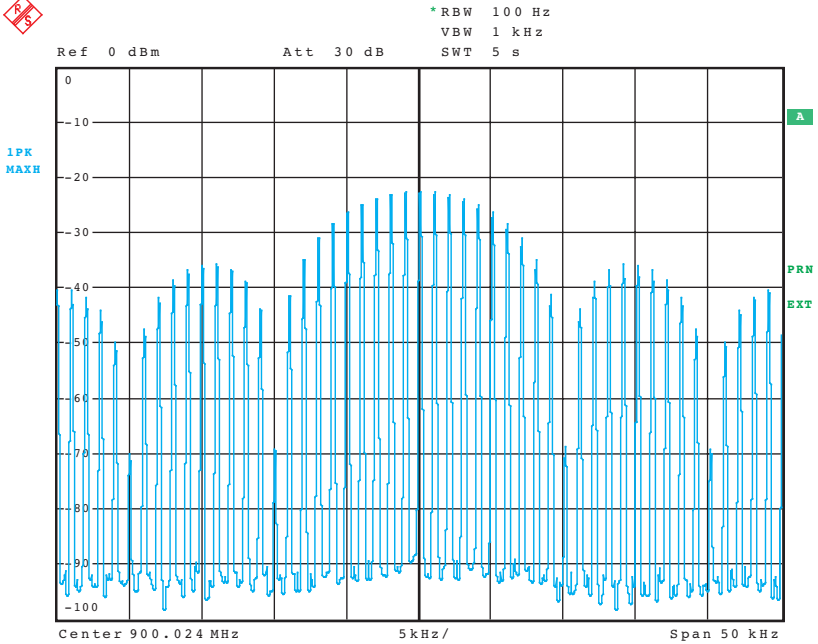

Fig. 6-11 Real representation of line spectrum with a spectrum analyzer,
same settings as in Fig. 6-10, but 100 Hz measurement bandwidth

Triangular and trapezoidal pulses

The spectrum of a triangular pulse with equal rise and fall time exhibits an envelope that corresponds to a si^2 function. The trapezoidal pulse can be obtained from a combination of rectangular and triangular pulse. The effect of additional time constants is noticeable in the differently decaying amplitudes of the log-log density spectrum. While with the trapezoidal pulse at $1/\text{pt}$ the envelope of the amplitude density spectrum decreases 20 dB per decade, it decreases 40 dB per decade in the case of equal rise and fall time. If the time constants are different, there is a decrease of 20 dB per decade at the first (smaller) corner frequency and of another 20 dB per decade at the second (larger) corner frequency, similar to the characteristic of the trapezoidal pulse.

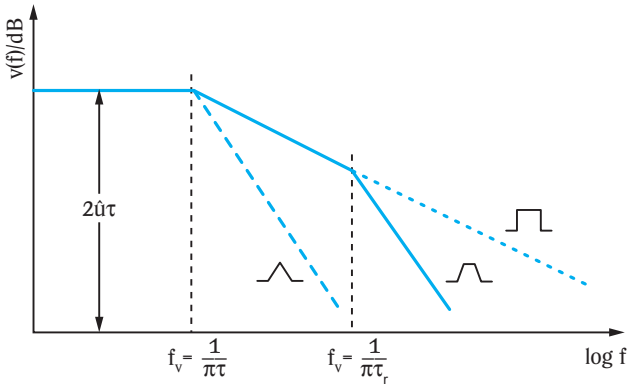

Fig. 6-12 Amplitude density spectrum for rectangular, trapezoidal and triangular pulses (diagram is shown for $\tau_{\text{rise}} = \tau_{\text{fall}}$)

Considering $\tau \rightarrow 0$ clearly reveals that this corner frequency (Fig. 6-12) is shifted towards infinitely high frequencies. Examination of the boundary case that the period $T \rightarrow \infty$ ($\Delta f = 1/T \rightarrow 0$), yields a single pulse with infinitely high amplitude (Dirac pulse).

The Fourier series only allows the representation of periodic time domain functions. With the aid of the boundary conditions, $T \rightarrow \infty$, and $\Delta f \rightarrow 0$, non-periodic functions can also be described. This is possible with the aid of the Fourier transform and Fourier integral.

In practice, non-periodic events occur more frequently, such as switching operations, lightning strokes or electrostatic discharges.

6.2.2 Line and envelope spectrum

The energy of the periodic pulse occurs at the discrete frequencies $n \cdot f_1$ (Equation 6-7), or equivalently at $n \cdot 1/T$.

The envelope *si* function has nulls at the integer multiples as a function of the mark-to-space ratio τ/T . If the pulse signal is used for modulation of a carrier, the spectrum will be symmetrically distributed above and below the carrier frequency. Depending on the measurement or resolution bandwidth, the following three cases are possible when using a frequency-selective spectrum analyzer or test receiver for the spectrum measurement:

1. If the measurement bandwidth is small relative to the offset of the frequency lines (given by $1/T = \Delta f$), the individual spectral lines can be resolved so that a line spectrum is obtained.

$$B < 1/T \qquad \qquad \qquad \text{(Equation 6-9)}$$

A further reduction of the bandwidth yields equal amplitude values, reduces the noise and thus improves the signal-to-noise ratio with the bandwidth ratio $10 \cdot \log(B_1/B_2)$.

2. The bandwidth B is greater than the spacing Δf of the spectral lines, but smaller than the spacing $1/\tau$ of the first null of the envelope *si* function from the carrier frequency.

The spectral lines cannot be resolved and the amplitude height of the envelope depends on the bandwidth. This makes sense as the amplitude depends on the number of spectral lines collected within the measurement bandwidth.

$$1/\tau > B > 1/T \qquad \qquad \qquad \text{(Equation 6-10)}$$

The above condition is described as an envelope display. The envelope amplitude increases with increasing bandwidth by $20 \log B_2/B_1$.

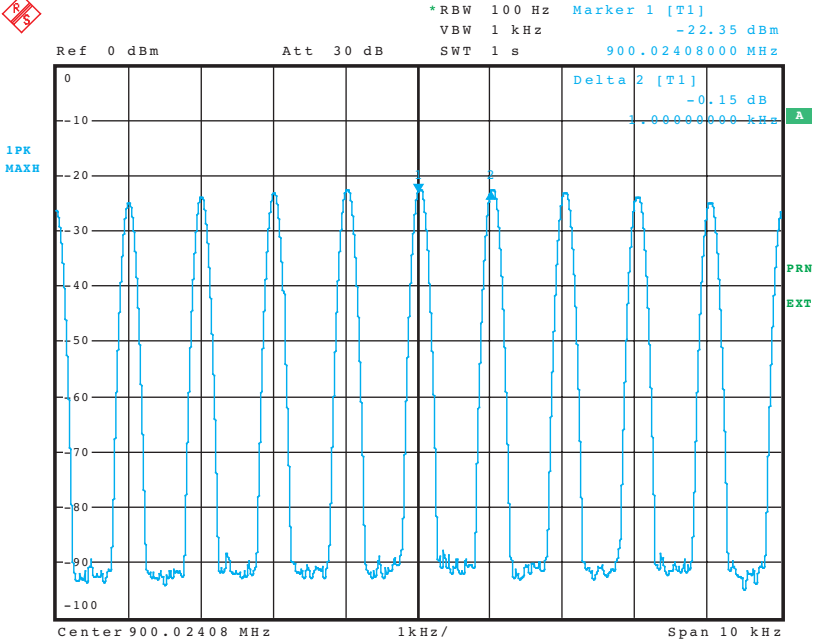

Fig. 6-13 Line spectrum of pulsed signal
 (measurement bandwidth $B = 100 \text{ Hz} < 1/T = 1 \text{ kHz}$)

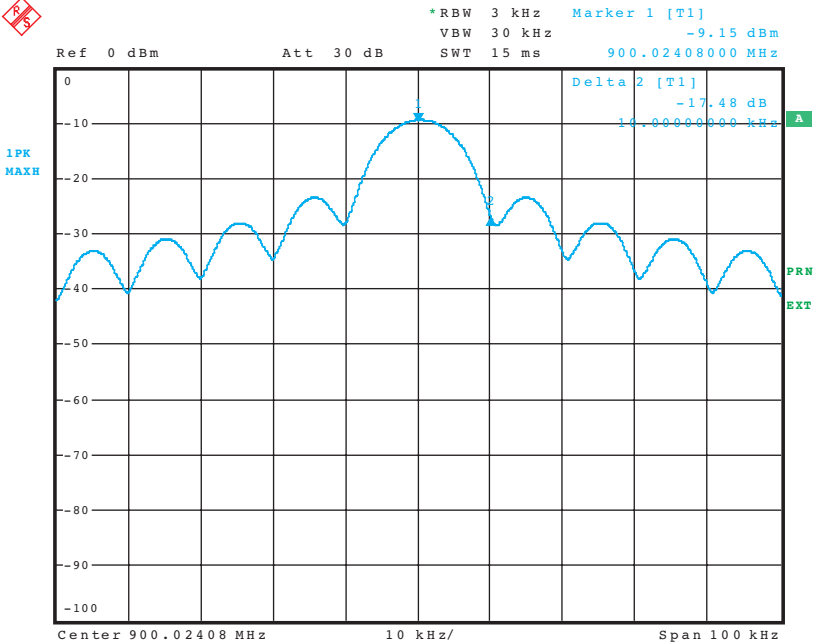

Fig. 6-14 Envelope spectrum of pulsed signals
 ($1/\tau = 10 \text{ kHz} > B = 3 \text{ kHz} > 1/T = 1 \text{ kHz}$)

3. The bandwidth B is greater than the null spacings of the envelope, selectivity is no longer effective and the amplitude distribution in the spectrum cannot be recognized any more. With increasing bandwidth the impulse response of the filter approaches the time function of the pulse-modulated carrier.

$$B > 1/\tau$$

(Equation 6-11)

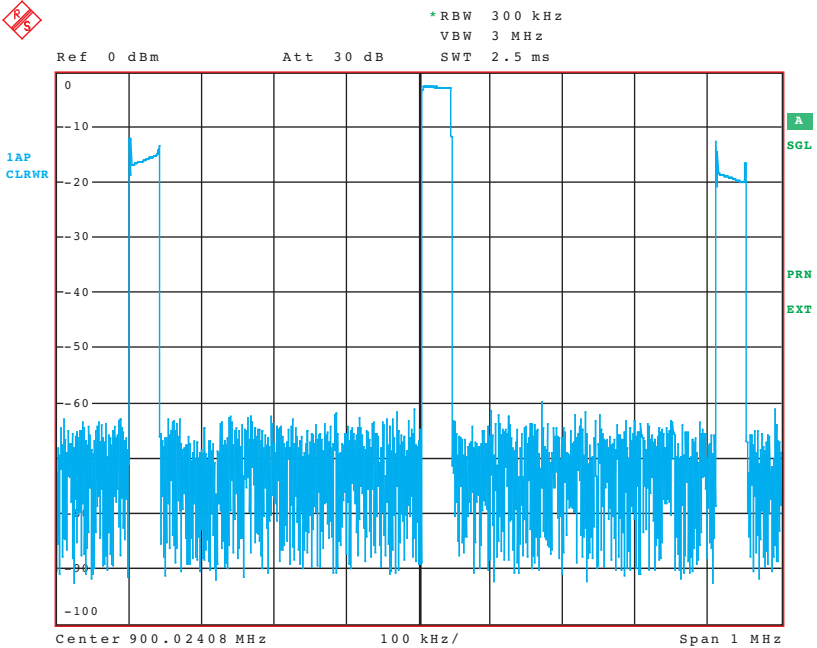

Fig. 6-15 Transition to display in time domain. Pulse duration of $100 \mu\text{s}$ and period of 1 ms can be clearly recognized

To put it simply:

- In the case of the line spectrum the number of lines does not vary as a function of the bandwidth or frequency span, the amplitude remains constant.
- In the case of the envelope spectrum the number of lines varies as a function of the bandwidth and not as function of the frequency offset. The displayed amplitude increases with the resolution bandwidth due to the larger energy component within the measurement bandwidth.

With pulse modulation, the displayed amplitude decreases with decreasing bandwidth, this effect being referred to as pulse desensitization. The relationship can be expressed by the determination of the pulse desensitization factor (PDF):

$$PDF_{line} = 20 \cdot \log(\tau/T) \tag{Equation 6-12}$$

for amplitude values in the line spectrum and

$$PDF_{envelope} = 20 \cdot \log(\tau KB) \tag{Equation 6-13}$$

for amplitude values in the envelope spectrum. The shape factor K depends on the type of the resolution filter used and is described in detail in the following section. Typical examples are K = 1 for Gaussian filters and K = 1.5 for rectangular filters. For pulse signal measurements, a compromise has to be found since with small resolution bandwidths the displayed amplitude may become too small, whereas with large resolution bandwidth the displayed amplitude will be larger but the resolution degraded to an increasing extent. In practice, the following value has been empirically determined:

$$\tau \cdot B = 0.1 \tag{Equation 6-14}$$

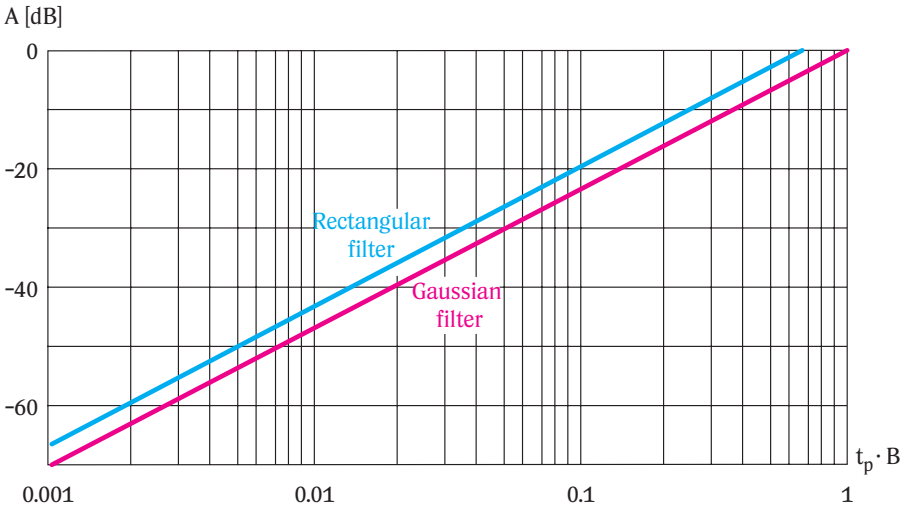

Fig. 6-16 Amplitude loss as a function of time/bandwidth product $\tau \cdot B$

Examples:

A pulse of the duration $\tau = 2 \mu\text{s}$ and pulse repetition frequency of 5 kHz ($= 1/T$), corresponding to a period $T = 200 \mu\text{s}$, is measured with a Gaussian filter ($K = 1$) of bandwidth $B = 1 \text{ kHz}$.

The condition according to Equation 6-9 applies ($B < 1/T$), so we have a line spectrum. Equation 6-12 then gives:

$$\text{PDF}_{\text{line}} = 20 \cdot \log(2 \mu\text{s}/200 \mu\text{s}) = -40 \text{ dB}$$

Accordingly, the displayed amplitude value of the unmodulated carrier would be 40 dB higher.

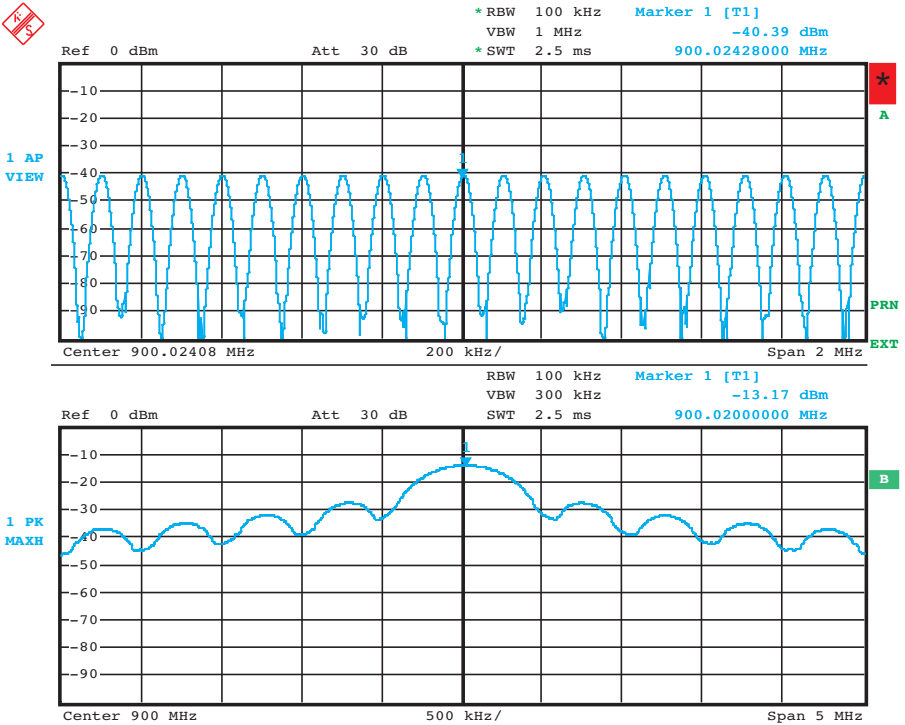

Fig. 6-17 Pulse spectra measured with different bandwidths. The markers display the desensitization factor. The unmodulated carrier level is 0 dBm

The same measurement is repeated with the same parameters, but with a measurement bandwidth B of 100 kHz. The relationship according to Equation 6-10 applies ($1/\tau > B > 1/T$). Equation 6-13 then gives:

$$PDF_{\text{envelope}} = 20 \cdot \log(2 \cdot 10^{-6} \cdot 1 \cdot 100 \cdot 10^3) = 20 \cdot \log(2 \cdot 10^{-1}) = -14 \text{ dB}$$

The maximum amplitude of the spectrum is 14 dB lower than that of the unmodulated carrier.

6.2.3 Resolution filters for pulse measurements

The spectral lines of broadband pulse signals are correlated, so the displayed level doubles when the measurement bandwidth is doubled. To determine the actual pulse bandwidth, the displayed level with the use of a real filter is compared with the displayed level from an ideal rectangular filter. For Gaussian filters, which are mostly used due to their favorable transient response, the following relationship is obtained:

$$B_f = 1.506 \cdot B_{3dB} \tag{Equation 6-15}$$

where B_f = pulse bandwidth, in Hz

The pulse bandwidth of Gaussian or Gaussian-like filters corresponds approximately to the 6 dB bandwidth. For spectrum analyzers, the 3 dB bandwidths are usually specified, whereas for EMI measurements, where often pulses are measured, 6 dB bandwidths are stated.

The relationship between 3 dB, 6 dB, noise and pulse bandwidths for different filters was described in chapter 4. The conversion factors can be directly taken from the table below.

Initial value is 3 dB bandwidth		4 filter circuits (analog)	5 filter circuits (analog)	Gaussian filter (digital)
6 dB bandwidth	(B_{6dB})	$1.480 \cdot B_{3dB}$	$1.464 \cdot B_{3dB}$	$1.415 \cdot B_{3dB}$
Pulse bandwidth	(B_p)	$1.806 \cdot B_{3dB}$	$1.727 \cdot B_{3dB}$	$1.506 \cdot B_{3dB}$
Initial value is 6 dB bandwidth				
3 dB bandwidth	(B_{3dB})	$0.676 \cdot B_{6dB}$	$0.683 \cdot B_{6dB}$	$0.707 \cdot B_{6dB}$
Pulse bandwidth	(B_p)	$1.220 \cdot B_{6dB}$	$1.179 \cdot B_{6dB}$	$1.065 \cdot B_{6dB}$

It should be noted that the corner frequencies given by the pulse duration τ and the period T, or the pulse spectrum, must not be affected by a video filter. Modern measuring instruments have selectable coupling factors between measurement or resolution bandwidth and video bandwidth as well as between measurement and settling times. Depending on the given conditions, a preset coupling factor or a user-selectable factor may be defined for pulse measurements so that the video bandwidth may exceed the measurement bandwidth by a factor of 10.

Implementation of the resolution bandwidth using digital filters has no effect on the weighting of pulse signals. Digital filters are suited just as well as analog filters and, in addition to temperature and long-term stability, they feature the advantage of being highly selective, so filters with lower shape factor can be realized.

If spectrum analyzers exclusively operate on the basis of fast Fourier transform (FFT), they are not suitable for pulse measurements. With FFT, the spectrum is calculated from a section of the time domain signal. As explained in chapter 3.1, the measurement results depend on the choice of this section, so that the FFT analysis is unsuitable for pulse signal analysis. It is therefore important that analyzers provide both analog/digital filters and FFT analysis.

6.2.4 Analyzer parameters

The above explanations have clearly shown that measurement and assessment of pulse signals is more complex with many more details involved than with sinusoidal signals. In spectrum analyzer or test receiver data sheets, the maximum input level for sinusoidal (CW) signals is speci-

fied. For pulse measurements, parameters such as pulse spectral density, maximum pulse energy or pulse voltage are important to avoid erroneous measurement or damage to the measuring instrument. It makes sense to define a parameter such as the pulse spectral density and to relate a pulse voltage to a reference bandwidth (chapter 5.4: 1 dB compression point and maximum input level). A reference bandwidth of 1 MHz has been defined for this purpose. The parameters are therefore given in the units $\mu\text{V}/1\text{ MHz}$ and $\text{dB}\mu\text{V}/1\text{ MHz}$.

The pulse spectral density can easily be calculated from the measured level using the following correction factor:

$$K_f = 20 \log (B_f/1 \text{ MHz}) \qquad \text{(Equation 6-16)}$$

Example:

In a spectrum analyzer the measurement bandwidth is determined by a Gaussian filter with a 3 dB bandwidth of 10 kHz. A pulse signal measurement yields a displayed level of -67 dBm. What is the pulse spectral density?

First, the measured value has to be converted into the unit $\text{dB}\mu\text{V}$. A level of 0 dBm corresponds to 107 $\text{dB}\mu\text{V}$. That is, -67 dBm corresponds to +40 $\text{dB}\mu\text{V}$. The pulse bandwidth is calculated for Gaussian filters according to Equation 6-15 with $\cdot B_{3\text{dB}}$ to give $B_f = 15\text{ kHz}$.

The correction factor of -36.5 dB is obtained from Equation 6-16:

$$K_f = 20 \cdot \log (B_f/1 \text{ MHz}) = 20 \cdot \log (15 \cdot 10^3 / 1 \cdot 10^6) = -36.5 \text{ dB}$$

The measured value of +40 $\text{dB}\mu\text{V}$ corresponds to a pulse spectral density of 76.5 $\text{dB}\mu\text{V}/1\text{ MHz}$.

A detailed description of maximum pulse energy and voltage, which are further important parameters for the assessment of spectrum analyzers and test receivers, can be found in chapter 5.4.

Certain instruments can even have two separate RF inputs, one of them being pulse-protected for handling high maximum pulse voltage peaks. Pulse energy is applied to the subsequent attenuator which is designed to dissipate the resulting heat. In the case of inadequate heat dissipation, components may be damaged.

6.2.5 Pulse weighting in spurious signal measurements

So far we have considered wanted signals that serve for transmitting information. As mentioned at the beginning of chapter 6.2, the measurement and weighting of unwanted spurious signals is another important aspect in the analysis of pulse signals.

The subject of electromagnetic compatibility is very complex because almost every electronic device not only produces wanted but also unwanted signals or couples the wanted signals into the signal path at some point. The mechanism is made even more complex by the fact that spurious emissions may be propagated on radiated or conducted paths.

Reproducibility of the spurious signal measurement is ensured by standards and guidelines. The relevant EMC standards define product-specific limit lines taking into account the DUT's field of application (domestic, industrial or military environment). For commercial measurements (in contrast to military standards), a specially designed and calibrated detector known as quasi-peak detector is used for weighting continuous pulse signals according to their pulse repetition frequency. The weighted levels can be compared to the defined limit lines. If the determined level values are below these limit lines, interference-free operation of the DUT within the context of electromagnetic compatibility can be assumed.

With the matched circuitry, conducted pulses are not so hazardous provided that their energy does not exceed a certain limit value. It is more often the case that the interference pulse triggers some kind of oscillator.

Examples:

According to the above and Fig. 6-12 it is shown that the bandwidth occupied by an interference pulse is inversely proportional to its duration. This means that if an interference pulse with a pulse width of $1\ \mu\text{s}$ has its first null at 1 MHz in the frequency spectrum, a decay of the spurious amplitudes becomes significant from about 300 kHz. A 100 ns interference pulse shows this decay at 3 MHz.

Furthermore, a pulse amplitude of 1 V is assumed. Accordingly, a pulse of $1\ \mu\text{s}$ width has an energy (product of voltage and time) of $1\ \mu\text{Vs}$. A 100 ns interference pulse of 10 V amplitude also has an energy of $1\ \mu\text{Vs}$. With a pulse bandwidth setting of 10 kHz, the spectrum analyzer indicates for the two pulses, both for the $1\ \mu\text{s}$ and for the 100 ns pulse, a voltage of 10 mV on its display referred to the RMS value of a sinewave voltage. This means that the spectrum analyzer cannot differentiate between the pulse amplitudes. From the observed voltage value, no conclusions as to over-driving can be made either since the same value will be displayed for a 10 ns pulse of 100 V in amplitude.

6.2.5.1 Detectors, time constants

The peak detectors described in chapter 4.2, such as max peak, min peak, auto peak and sample detectors, are standard in most spectrum analyzers. RMS (root mean square) and AV (average) detectors are also implemented in state-of-the-art instruments.

A special detector for interference pulse measurements referred to as a quasi-peak detector (QP) is frequently available as an option. It places high demands on the dynamic range and linearity of the input as well as of the IF stage, which cannot be satisfied by a large number of instruments available on the market. The requirements are the result of the weighting characteristic for pulse sequences (prescribed by CISPR 16-1 standard) which, due to underweighting of pulse sequences at low pulse repetition frequency (up to 40 dB for single pulses), calls for a dynamic range that is wider than non-state-of-the-art-instruments by a factor of 100.

Relative input level for constant display in dB

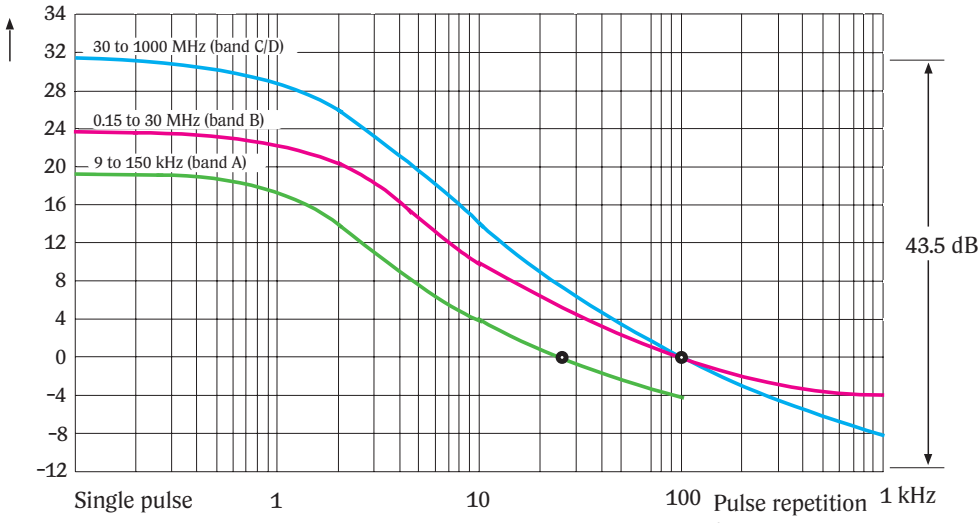

Fig. 6-18 Pulse weighting to CISPR 16 for different pulse repetition frequencies

In accordance with the frequency bands specified by CISPR, the quasi-peak detector is assigned defined charge and discharge time constants and bandwidths. It is thus ensured that in the different CISPR bands, the measured values are always collected with the same time constants and same bandwidth (usually the pulse bandwidth) to provide for reproducibility and comparable limit lines. This is referred to as a weighted display of the QP detector and pulse weighting curve, which also contains the time constant resulting from the inertia of mechanical meters.

The CISPR bands are defined as follows:

- CISPR A 9 kHz to 150 kHz
- CISPR B 150 kHz to 30 MHz
- CISPR C 30 MHz to 300 MHz
- CISPR D 300 MHz to 1000 MHz

Frequency band	6 dB measurement bandwidth	Charge time of QP detector	Discharge time of QP detector	Time constant of meter
CISPR A	200 Hz	45 ms	500 ms	160 ms
CISPR B	9 kHz	1 ms	160 ms	160 ms
CISPR C	120 kHz	1 ms	550 ms	100 ms
CISPR D	120 kHz	1 ms	550 ms	100 ms

The weighting of different pulse repetition frequencies shows that the greatest difference between the displayed levels is at low pulse repetition frequencies. With increasing pulse repetition frequency (PRF), for instance PRF >10 kHz, the levels displayed by all detectors (AV, RMS and QP) approach the value of the peak detector.

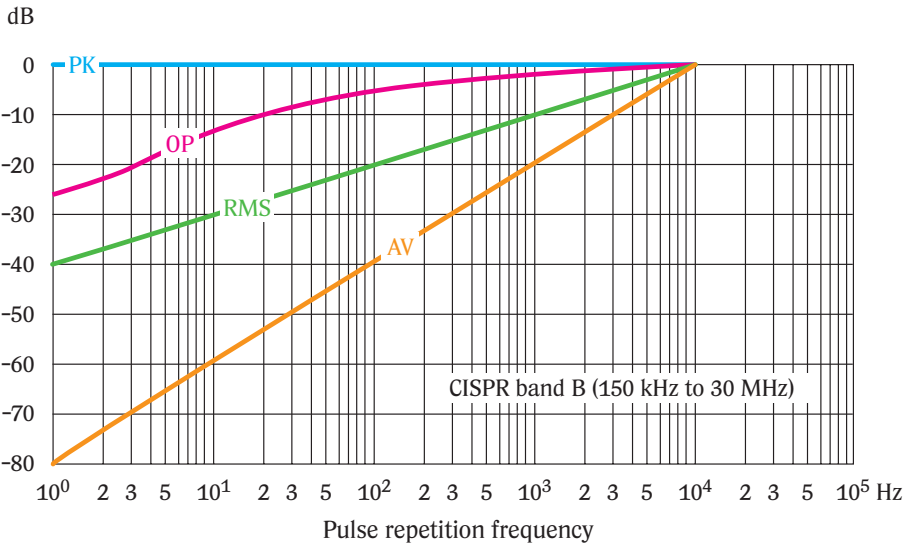

Fig. 6-19 Levels displayed with different detectors and pulse repetition frequencies relative to peak display

Special standard pulse generators are available for calibration of the QP display of spectrum analyzers and test receivers. Exacting requirements are placed on such standard pulse generators. For the calibration of test receivers up to 1 GHz, pulses with a width of much less than 1 ns are required, in practice usually 200 or 250 ps. In addition to the short pulse duration, extremely short pulse rise and fall times can also be realized. The pulse frequency of the generator must be variable for simulating the CISPR weighting curve.

Peak detector PK/MHz

Another way of specifying the level in EMI measurements is the peak value referred to a 1 MHz bandwidth. In this display mode the pulse spectral density of the input signal is measured. The peak value at the output of the envelope demodulator within the selected measurement time is referred to 1 MHz. It should be noted that due to the measurement bandwidth, the displayed peak value is increased by $20 \cdot \log(1 \text{ MHz}/B_i)$.

Broadband and narrowband interference

Different pulse weighting methods are used in EMC. These are based on the different limit values defined for broadband and narrowband interference. Broadband interference is relatively evenly distributed over the spectrum, but due to this flat spectral distribution, the disturbance is lower than that of a sinusoidal spurious signal (narrowband interferer) of a very high level. The permissible spurious emission limit values are 10 dB higher than the narrowband limit values (depending on the relevant standard). This means that a narrowband interferer should be suppressed in a circuit (attenuated by at least 10 dB) by suitable RFI rejection or shielding.

The detector method and bandwidth detuning method are suitable to differentiate between broadband and narrowband interference.

The detector method is based on the assumption that narrowband interference weighted once by a peak detector and once by an average detector yields approximately the same result (difference < 6 dB). If there is a greater difference, the interference is of broadband nature and the limit values for broadband interference have to be applied. The detector method can employ both a PK /AV and a PK /RMS detector comparison, depending on the standard used.

The bandwidth detuning method assumes that a signal level is displayed with the selected peak detector, and used as a reference value. The measurement is repeated with the same settings, but with the center frequency shifted by $\pm(\text{measurement bandwidth } B)$. If the two new values are less than the critical threshold (6 dB) of the reference level, the signal is considered to be a narrowband interferer. An interferer that is not identified as being narrowband is considered to be broadband. The detuning method can also be carried out with the center frequency shifted by $\pm 2B$. Both methods are permitted in the relevant standards.

6.2.5.2 Measurement bandwidths

The measurement bandwidths specified in the standards for pulse measurements within spurious emission measurements are to be understood as pulse bandwidths. For commercial standards, these are the bandwidths of

200 Hz, 9 kHz, 120 kHz (civil specifications, such as EN, VDE, FCC, VCCI, etc),

whereas for military standards the following decade steps apply:

10 Hz, 100 Hz, 1 kHz, 10 kHz, 100 kHz, 1 MHz.

These bandwidths (designated as pulse bandwidths) as well as the QP detector are additionally implemented in modern spectrum analyzers which, due to their performance features regarding overload capability and dynamic range, are suitable for spurious emission measurements.

6.3 Channel and adjacent-channel power measurement

(Dipl.-Ing. Roland Minihold)

6.3.1 Introduction

Advanced 3rd generation mobile radio systems operating on the CDMA principle (code division multiple access) have a frequency multiplex component like that of the 2nd generation TMDA systems (time domain multiple access systems, such as GSM or IS-136) or the traditional 1st generation analog FDMA systems (frequency domain multiple access, such as AMPS).

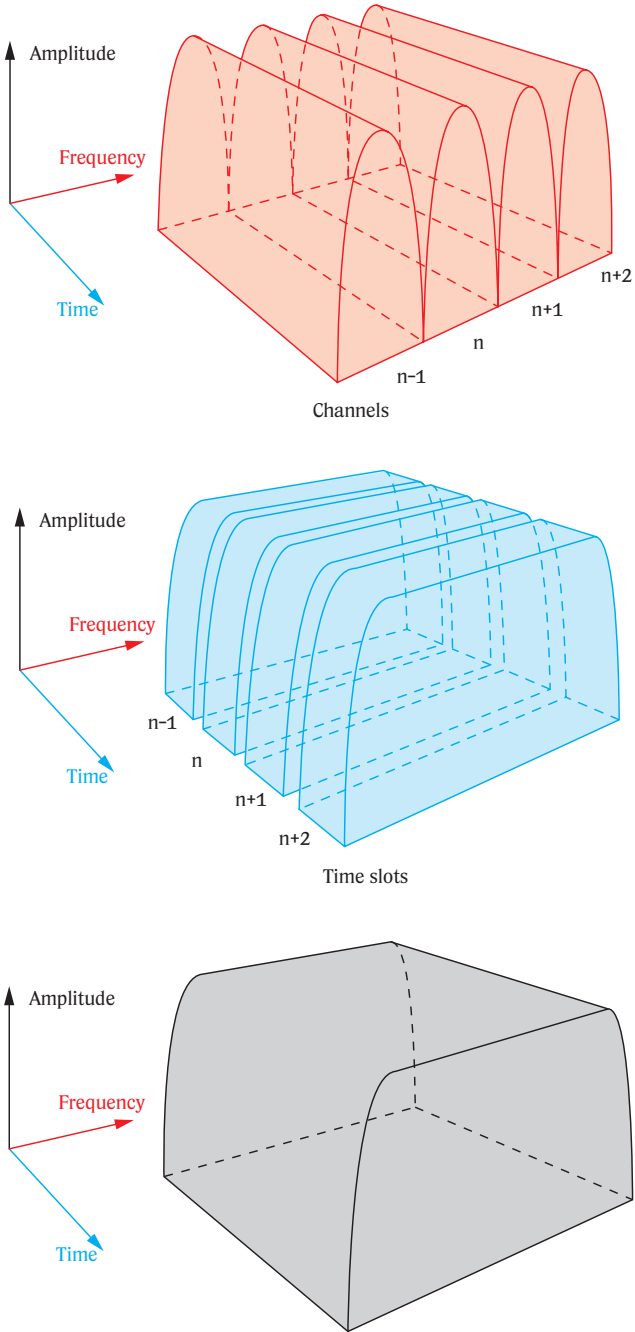

Fig. 6-20 Various methods of channel generation in (mobile) radio systems by signal multiplexing: FDMA (a), TDMA (b) and CDMA (c)

This means that in all these systems there are several adjacent radio channels in the frequency band providing multiple access. The main difference between the various systems lies in the fact that compared to the traditional analog radio systems, the radio channels occupy a larger bandwidth. In the traditional analog radio system such as the American AMPS system, each user is allocated a separate transmit and receive channel, which are both occupied over the whole duration of active radiocommunication. In TDMA systems, several users either share transmit and receive channels in the time domain (frequency duplex as in the GSM systems), or transmit and receive channel are identical (time duplex as in DECT systems). In mobile radio systems operating on the CDMA principle, many users (often approximately 128) share sufficiently wide transmit and receive channels. The two channels are used over the whole duration and the individual users are separated using despreading codes.

To ensure undisturbed reception for a large number of users, it is absolutely necessary to avoid interference with adjacent transmission channels in the frequency band. An important criterion is a sufficiently low adjacent-channel power specified either as absolute value (in dBm) or relative value referred to the channel power in the transmit channel (in dBc).

For cdmaOne systems (IS-95, 1.25 MHz channel bandwidth), additional limit values have been prescribed for signals emitted in neighboring analog radio channels of the AMPS systems (30 kHz channel bandwidth).

In TDMA systems (such as IS-136 or GSM), the transmitter power, and hence the unwanted power radiated in the adjacent channels, is only applied in certain timeslots, so that special measures such as gating (measurement only during the active timeslot) are required. A distinction is usually made as to whether the spurious emissions in the adjacent channels are caused by the modulated stationary transmitter signal (spectrum due to modulation) or by the on/off switching of the transmitter signal (spectrum due to switching). A spectrum analyzer intended for performing measurements on TDMA systems should therefore feature suitable functions for adjacent-channel power measurement as well as gating and trigger functions.

6.3.2 Key parameters for adjacent-channel power measurement

In addition to the channel bandwidth of the user channel and the adjacent channels, the channel spacings are important parameters for adjacent-channel power measurements. Channel spacing is understood as the difference between the center frequency of the user channel and that of the adjacent channel.

The number of adjacent channels in which the channel power is measured is also important. The table below shows the channels to be measured according to the number of channels set:

No. of channels	Channel power measurement
0	User channel only
1	User channel and upper/lower adjacent channel
2	User channel and adjacent channels + 1st alternate channels
3	User channel and adjacent channels + 1st alternate channels + 2nd alternate channels

As shown in Fig. 6-21, the adjacent channels have different designations according to their position relative to the user channel. In our example, two channels will be set.

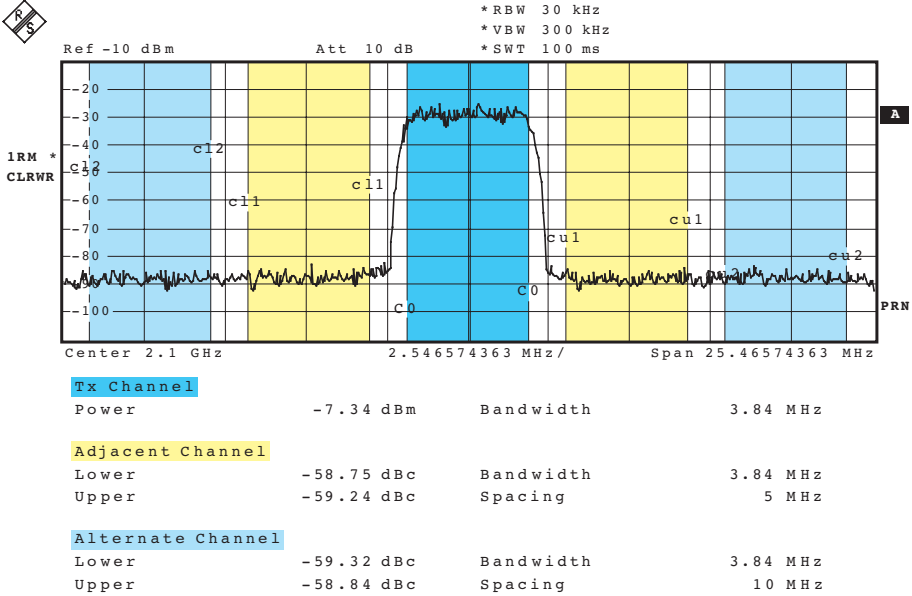

Fig. 6-21 Position of user channel and adjacent channels in frequency domain, here for a WCDMA signal

6.3.3 Dynamic range in adjacent-channel power measurements

(see also chapter 5.5: Dynamic range)

The dynamic range achievable in adjacent-channel power measurements using a spectrum analyzer is influenced by three factors, assuming sufficient filter selectivity for user channel suppression and ideal signal:

- **Thermal inherent noise of analyzer**
In this case it is the signal-to-noise ratio achieved with the specific device setting (measurement level on analyzer, RF attenuation, reference level).
- **Phase noise of the analyzer**
- **Intermodulation products (spectral regrowth)**
Intermodulation products falling within the adjacent channels are a crucial factor especially in measurements on wideband CDMA systems.

The adjacent-channel power is obtained by linear addition of the above individual contributions. The contributions made by thermal noise and intermodulation products depend on the input level of the first mixer of the spectrum analyzer. While the effect of thermal noise decreases inversely proportionally with the mixer level, the intermodulation products increase. The sum of all power contributions gives the asymmetrical ‘bathtub’ characteristic shown in Fig. 6-22. The maximum achievable dynamic range can be determined for each mixer level.

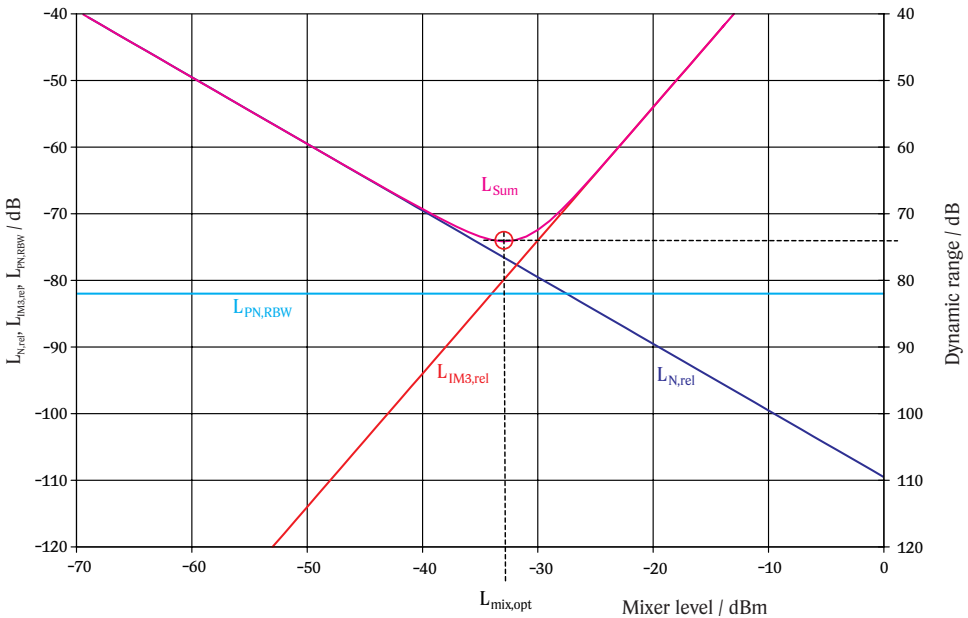

Fig. 6-22 Dynamic range taking into account thermal noise, phase noise and 3rd order intermodulation products

6.3.4 Methods for adjacent-channel power measurement using a spectrum analyzer

6.3.4.1 Integrated bandwidth method

The IF filters of spectrum analyzers are usually implemented in a relatively coarse raster of 1, 3 or 1, 2, 3, 5 steps. Moreover, their selectivity characteristics do not satisfy the requirements placed on channel filters. Analog IF filters are usually implemented as synchronously tuned four- or five-stage filters featuring optimized transient response to achieve minimum

sweep times. The selectivity characteristic of filters with a shape factor of approximately 12 for four-stage filters and approximately 9.5 for five-stage filters is rather poor and usually inadequate for sufficient suppression of the signal in the user channel for adjacent channel measurements. Digital resolution filters of modern spectrum analyzers that are usually implemented as Gaussian filters are not suitable as channel filters despite their better selectivity (shape factor of 4.6).

Therefore, spectrum analyzers usually offer power integration features in the frequency domain for adjacent-channel power measurement. Compared to the channel bandwidth, a very small resolution bandwidth of typically 1% to 3% of the channel bandwidth is set to ensure appropriate selectivity. The spectrum analyzer sweeps over the frequency range of interest from the start of the lower adjacent channel to the end of the upper adjacent channel depending on the number of measured adjacent channels (Fig. 6-21).

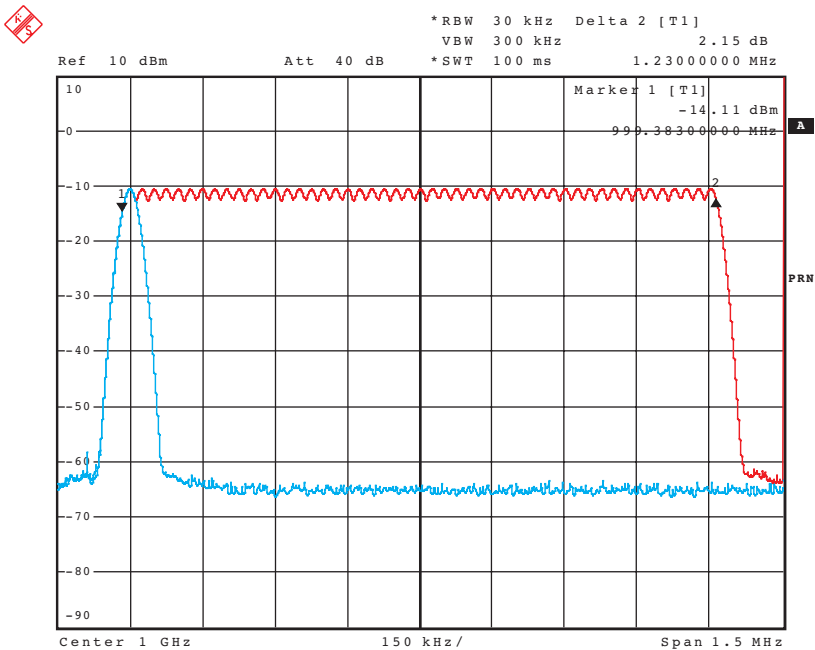

Fig. 6-23 Channel power measurement using integrated bandwidth method

The measured values corresponding to the levels of the displayed pixels are integrated within the selected channel bandwidth on a linear scale. The resulting adjacent-channel power is stated in dBc referred to the power in the user channel.

The following individual steps are carried out:

- For all levels measured within a channel, the power is determined on a linear level scale. The following applies:

$$P_i = 10^{(L_i/10)} \tag{Equation 6-17}$$

where P_i = power of a measured value represented by pixel i on linear level scale, in W
 L_i = level of a measured value represented by pixel i , in dBm

- The linear power of all trace points within a channel is summed up and divided by the number of trace points in the channel.
- The result in each channel is multiplied by the quotient from the selected channel bandwidth and noise bandwidth of the resolution filter.

From the above steps, the following relationship is obtained for the absolute channel power:

$$L_{Ch} = 10 \cdot \log \left(\frac{B_{Ch}}{B_{N,IF}} \cdot \frac{1}{n_2 - n_1} \cdot \sum_{n_1}^{n_2} 10^{P_i/10} \right) \tag{Equation 6-18}$$

where L_{Ch} = channel power level, in dBm
 B_{Ch} = channel bandwidth, in Hz
 $B_{N,IF}$ = noise bandwidth of IF filter, in Hz
 n_1, n_2 = indexes of measured values to be summed up
 P_i = power of a measured value represented by pixel i , in W

Selection of resolution bandwidth (RBW)

The selected resolution bandwidth should be small relative to the channel bandwidth for the channel bandwidth to be measured accurately. If the resolution bandwidth is too large, the selectivity of the simulated channel filter is insufficient and part of the main channel power will be measured when measuring the adjacent channels, so the final result will be incorrect. The well-chosen resolution bandwidth is typically 1% to 3% of the channel bandwidth. If the resolution bandwidth is too small, the required sweep time becomes unduly long, and the measurement time will be considerably increased.

Selection of detector

For power measurements within the channel bandwidth, the sample detector and the RMS detector are suitable since only these two detectors furnish results that allow power calculation. The peak detectors (max peak, min peak, auto peak) are not suitable for measuring noise or noise-like signals since a correlation between the detected video voltage and input signal power cannot be established.

When using the sample detector, the measured value represented by a pixel is derived from a sample of the IF envelope voltage. If the displayed spectrum is large relative to the resolution bandwidth (such as the span/RBW > 500), discrete signal components (sinusoidal signals) may get lost due to the limited number of pixels of the analyzer screen (approximately 501), and the channel or adjacent-channel power measurement will therefore be incorrect (chapter 4.4: Detectors).

Since digitally modulated signals are noise-like signals, the trace obtained with a sample detector is subject to large variations. To obtain stable results, averaging is necessary, in which case the displayed signal will be underweighted and falsified (chapter 4.5: Detectors).

When choosing the RMS detector, the power represented by a pixel is calculated from several measured values to obtain stable results. Moreover, the measurement time can be increased to allow averaging of the trace. The power of discrete spurious signals contained in the channel is also correctly determined. The RMS detector is therefore a better choice than the sample detector for channel power measurements.

The RMS value is calculated from the samples of the video voltage as follows:

$$V_{RMS} = \sqrt{\frac{1}{N} \cdot \sum_{i=1}^N v_i^2} \quad (\text{Equation 6-19})$$

where V_{RMS} = RMS value of voltage, in V
 N = number of samples allocated to the pixel concerned
 v_i = samples of envelope, in V

The reference resistance R can be used to calculate the power:

$$P = \frac{V_{RMS}^2}{R} \quad (\text{Equation 6-20})$$

Some TDMA mobile radio standards (such as PDC) prescribe a peak detector for measuring the adjacent-channel power (relative measurement) to ensure better detection of the power transients.

Selection of video bandwidth / trace averaging

When using an RMS or sample detector, the video bandwidth must be at least three times the resolution bandwidth to avoid averaging of the video voltage, as this would lead to underweighting of noise-like signals, resulting in channel power that would be too low. For this reason, trace averaging over several traces should also be avoided.

6.3.4.2 Spectral power weighting with modulation filter (IS-136, TETRA, WCDMA)

For determining the power in the main and adjacent channels of some mobile radio systems, such as IS-136 (NADC), TETRA and WCDMA, it is necessary to use a channel filter that corresponds to the modulation filter of the respective system (typically root-raised cosine filter). This leads to a more realistic weighting of the effect of the power emitted in the adjacent channel since interference is mainly caused by signal components in the center of an adjacent channel. Signal components close to the channel boundaries are suppressed by the matched filter of the receiver so that these cause less interference.

When using a spectrum analyzer for adjacent-channel power measurements, the individual trace values in respective channels must be weighted with a standard-specific modulation filter before each channel power is determined by integration of the measured values. Modern spectrum analyzers provide measurement functions with automatic weighting.

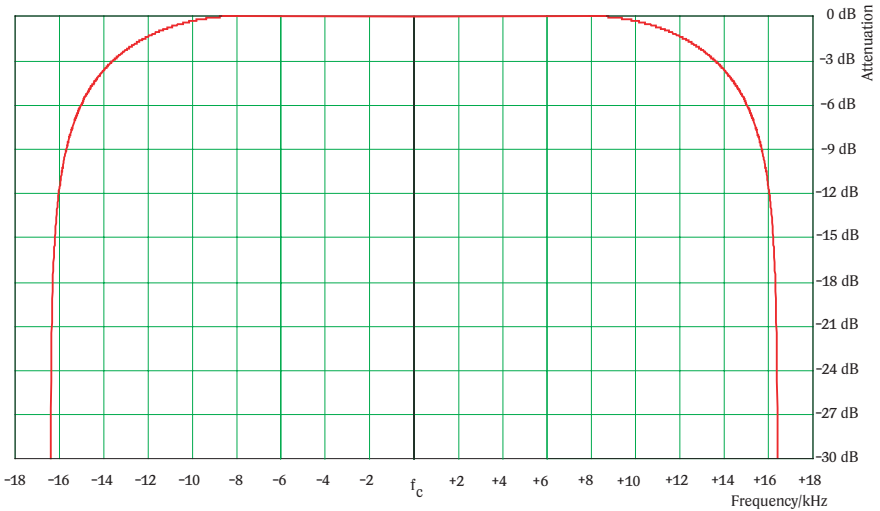

Fig. 6-24 Channel filter for IS-136 (NADC) systems

Use of a weighting filter in channel power measurements with a spectrum analyzer can very easily be verified by using the following test:

With the channel power measurement activated, a sinusoidal signal with a frequency corresponding to the channel center frequency is applied to the spectrum analyzer input. The measured channel power is used as a reference.

The frequency of the sinusoidal signal is then varied in steps towards the channel boundaries (or alternatively by varying the channel center frequency on the spectrum analyzer in case of a fixed-frequency sinusoidal signal) and the measured channel power observed. If the channel power varies under these conditions, a channel filter is obviously being used for weighting.

This test can also be carried out in the adjacent channels. It is recommended to set the spectrum analyzer for absolute adjacent-channel power measurement.

6.3.4.3 Channel power measurement in time domain

As explained in chapter 6.3.4.1, very narrowband resolution filters are required for channel power measurements. Since these filters exhibit low integration times, their use inevitably leads to relatively long sweep times. If measurements are carried out over several adjacent channels, frequency ranges between the individual channels will be included that contain no information of interest, but contribute to the total sweep time. All these drawbacks can be avoided by measuring the channel power in the time domain.

With the aid of digital signal processing, practically any type of channel filter can be digitally implemented for modern spectrum analyzers, such as root-raised cosine filters or near ideal rectangular bandpass filters as well as filters with very large bandwidth (such as 4 MHz). These filters allow channel power measurement in the time domain with the spectrum analyzer being tuned like a receiver to the center frequency of the channel. In this way it is possible to avoid the limitation of the minimum sweep time given by the transient time resulting from the narrow resolution bandwidths that are required for measurements in the frequency domain. In the time domain, a much better reproducibility of the measurement results can be achieved with the same measurement time as in the frequency domain, and the measurement time can be considerably reduced compared to the conventional integration method.

If the power is to be measured in several adjacent channels, the spectrum analyzer is automatically successively tuned to the respective channel center frequencies. Frequency ranges between the various channels of interest are skipped so that there is the further advantage in measurement time compared to measurements in the frequency domain.

Another benefit of time-domain measurements is the correct detection of transient signals caused by switching operations.

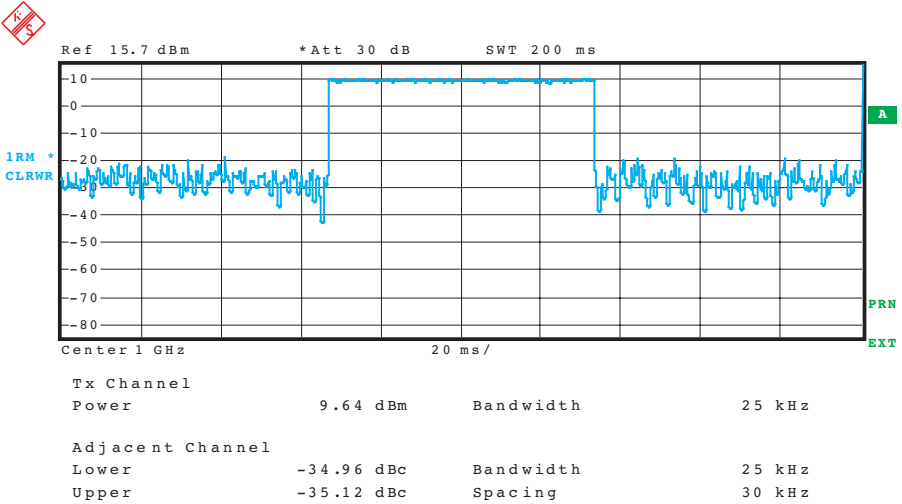

Fig. 6-25 Channel and adjacent-channel power measurement in time domain, here with IS-136 signal

6.3.4.4 Spectral measurements on TDMA systems

For measuring the adjacent-channel power on switched signals in TDMA systems, some special aspects have to be considered.

If the adjacent-channel power is to be determined from the modulation and phase noise of the transmitter, the detection of transient signals caused by on/off switching operations must be avoided. Measured values should therefore only be collected within the active timeslot (burst). This is possible by using gating features.

Derived from an external trigger signal or from a broadband level detector within the spectrum analyzer (RF trigger), a corresponding time window, or gate, is set during which measured values are collected. No measured values are recorded outside this gate, during which the frequency sweep is stopped.

With correct setting, the effective sweep time required for this measurement to examine a certain frequency range is longer than a normal sweep, namely by the reciprocal value of the on/off ratio t_{on}/t_{off} .

Many analyzers can be triggered by a video signal. This trigger source, however, is not suitable for spectral measurements on TDMA systems since the selectivity of the selected resolution bandwidths prevents gating from being activated. In this case, the sweep would not be triggered.

Transient adjacent-channel power (power components in the adjacent channels produced by switching operations) cannot be correctly detected by integration in the frequency domain. The reason is that the necessary filter is too narrow to be compared to the channel bandwidth (1% to 3% of channel bandwidth), and cannot reach steady state for transients.

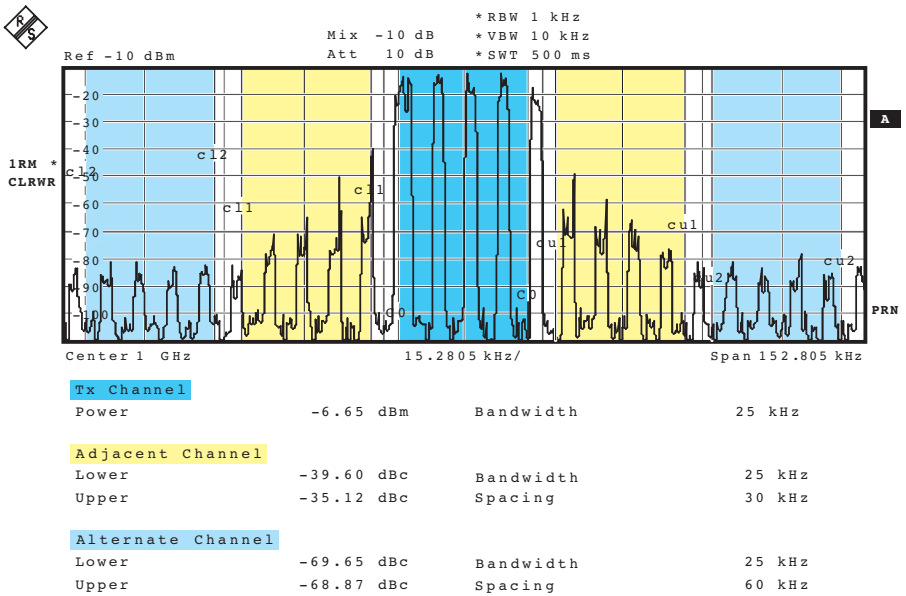

Fig. 6-26 Adjacent-channel power measurement without gating, here with IS-136 signal in one active slot only

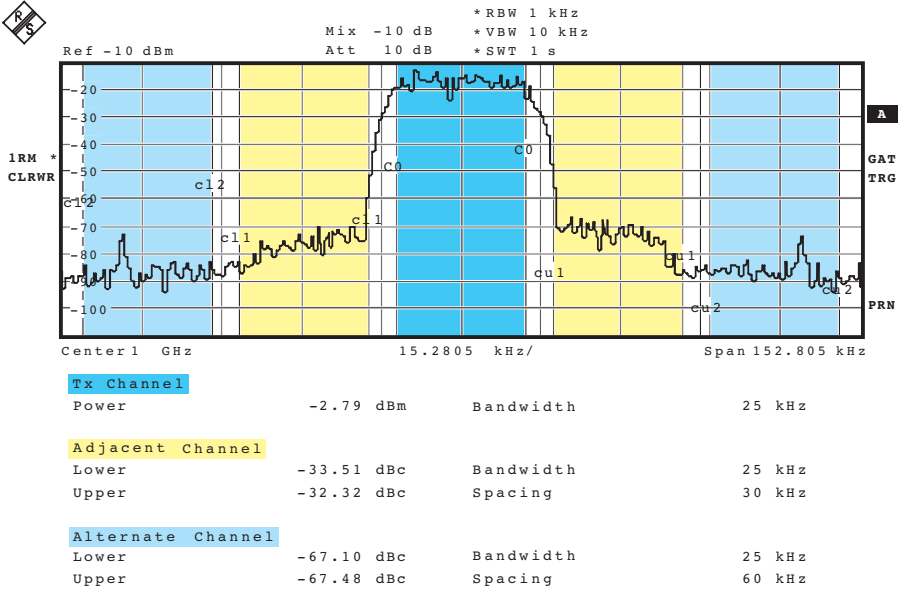

Fig. 6-27 Adjacent-channel power measurement on IS-136 signal with correctly set gating (spectrum due to modulation)

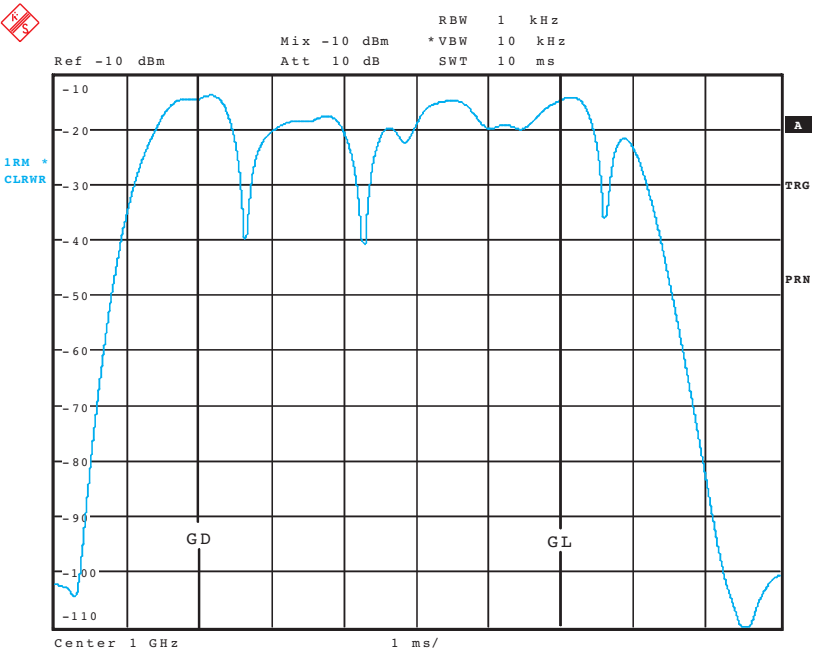

Fig. 6-28 Gate setting in time domain

References

- [2-1] Brigham, E.O.: The Fast Fourier Transform and its Application. Prentice Hall, 1988
- [3-1] Parks, T.W., Burrus, C.S.: Digital Filter Design. John Wiley & Sons, Inc., New York, Chichester, Brisbane, Toronto, Singapore, 1987.
- [3-2] Oppenheim, A.V., Schaffer, R.W.: Discrete-Time Signal Processing. Prentice Hall, 1989.
- [4-1] Helszajn, J.: YIG Resonators and Filters. John Wiley & Sons Ltd., Chichester, New York, Brisbane, Toronto, Singapore, 1985.
- [4-2] Rauscher, C.: Frequency Range Extension of Spectrum Analyzers with Harmonic Mixers. Application Note*) 1EF43_0E, Rohde & Schwarz.
- [4-3] Volder, J.E.: The CORDIC Trigonometric Computing Technique. IRE Transaction on Electronic Computers, vol. EC-8, Seite 330-334, Sept 1959.
- [4-4] CISPR 16-1 (1997-07): Specification for radio disturbance and immunity measuring apparatus and methods, Part 1: Radio disturbance and immunity measuring apparatus.
- [5-1] Winder, S.: Single Tone Intermodulation Testing. RF Design, Dezember 1993, p. 34.
- [5-2] Freed, J.G.: Equations Provide Accurate Third-Order IMD Analysis. Microwaves & RF, August 1992, p. 75.
- [5-3] Rohde, U.L.: Microwave and Wireless Synthesizers Theory and Design. John Wiley & Sons, Inc., New York, Chichester, Weinheim, Brisbane, Singapore, Toronto, 1997.
- [5-4] Beck, B.: Understand the Effects of Retrace and Aging in OCXOs. Microwaves & RF, November 1998, p. 72.

[5-5] Wolf, J.: Level Error Calculation for Spectrum Analyzers. Application Note*) 1EF36_0E, Rohde & Schwarz.

*) Rohde & Schwarz Application Notes are available on the Internet under www.rohde-schwarz.com.

The current* spectrum analyzer models from Rohde & Schwarz

*As of summer 2001

High-end allrounders: Spectrum Analyzer Family FSU

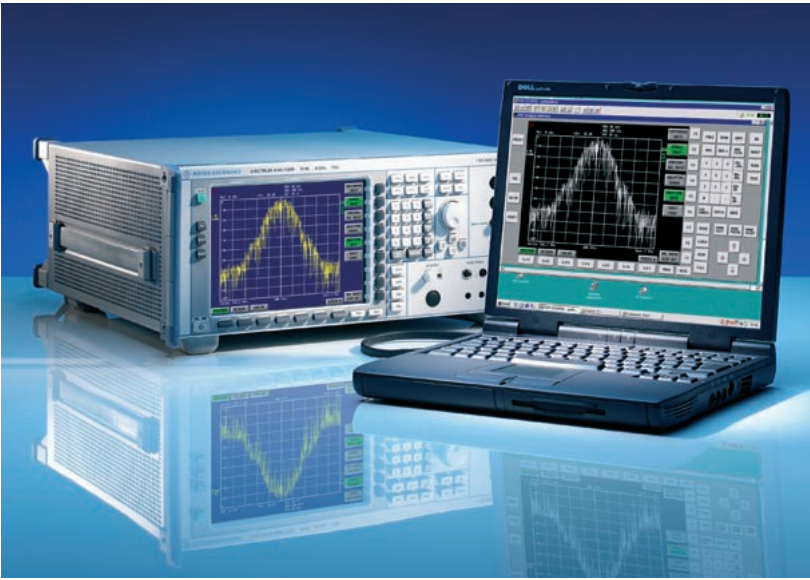

The FSU models introduced in 2001 set new standards for all RF performance data of spectrum analyzers. This applies to dynamic range, overload capacity, phase noise and measurement accuracy alike. The instruments are equipped to match their outstanding data. The FSU is the first general-purpose spectrum analyzer with a resolution bandwidth of 50 MHz, which is ideal for measurements on broadband communication systems. A full choice of detectors, numerous resolution filters and filter characteristics, as well as automatic routines for many standard measurement tasks make these instruments extremely efficient and economical tools for use in the development lab and in production environments. Application firmware packages, such as for GSM/EDGE or WCDMA, are available to enhance the comprehensive basic configuration by adding special mobile radio measurement functions, including modulation measurement.

Fully equipped high flyers: Spectrum Analyzers FSEM/FSEK

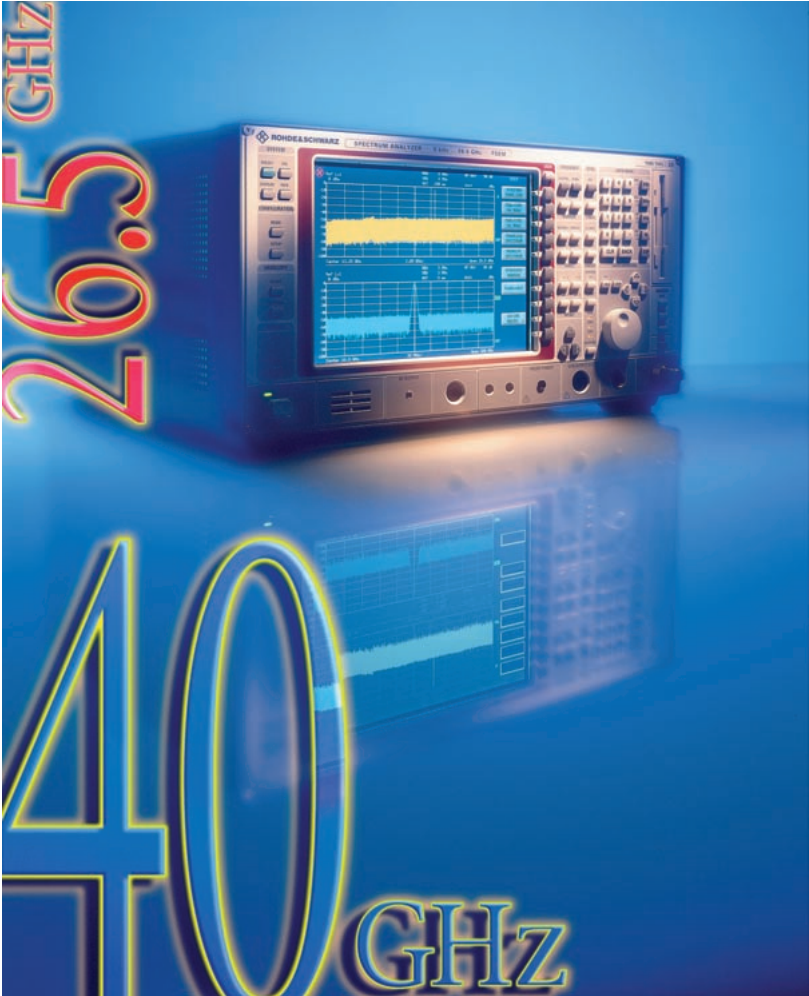

The Spectrum Analyzers FSEM and FSEK from Rohde & Schwarz for frequencies up to 26.5 GHz and 44 GHz are suitable for the upper microwave range. Use of the optional External Mixers FS-Zx opens up the range to 110 GHz, which is close to infrared. The analyzers are by no means purist high-frequency machines, but come with a comprehensive basic functionality that can be further enhanced for diverse measurement tasks by a large variety of options.

For third-generation mobile radio: Signal Analyzer FSIQ



The FSIQ models feature all the top performance data of the FSEx series and prove their benefits in all applications where high-grade spectrum analyzers are needed. Their primary application, though, is broadband vector signal analysis. The universal I/Q demodulator for symbol rates up to 6.4 Msymbols/s allows the analysis of digital mobile radio signals as well as of any communication devices using AM, FM or φ M.

The newly defined mid-range: Spectrum Analyzer Family FSP



The FSP family from Rohde & Schwarz now offers the performance and configuration features previously reserved for high-end equipment in an instrument in the medium price range. The FSP combines precision, RF performance and compact size as a result of a circuit design that uses digital signal processors especially developed for the FSP.

The EMC expert: EMI Test Receiver ESI

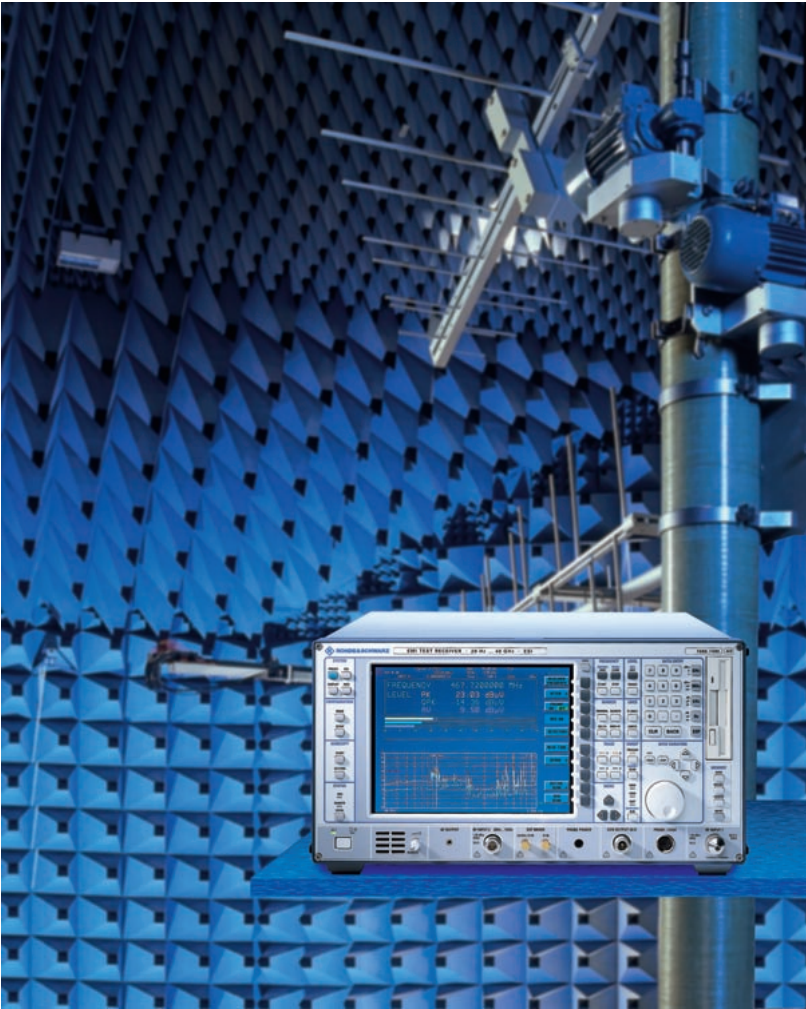

The designation as a "test receiver" is somewhat deceptive, since the ESI actually is a full-featured and high-grade spectrum analyzer. As a one-box solution for EMI compliance measurements, it provides all the functions required for EMI measurements conforming to standards. The ESI performs measurements to all relevant commercial and military standards, and its upper frequency limit of 40 GHz covers all frequency ranges that are significant for EMC measurements.

First choice for EMI measurements in product development: Test Receiver ESPI



In order to avoid unpleasant and expensive surprises at the end of product development due to extensive improvements which are required, developers should keep an eye on the EMI precompliance of their products during development. Test receivers/spectrum analyzers like the ESI, which uncompromisingly adhere to the relevant EMC standards, are not necessarily required. Somewhat less sophisticated instruments may be used, which nevertheless must provide reliable results on the EMC of a device under test so that the subsequent stringent compliance test becomes purely a formality. If such a measuring instrument can also be used as a high-grade allround spectrum analyzer - like the ESPI - there is no need for purchasing special measurement equipment, which usually will not be used to full capacity - especially in smaller enterprises.

Block diagram of spectrum analyzer described in this book

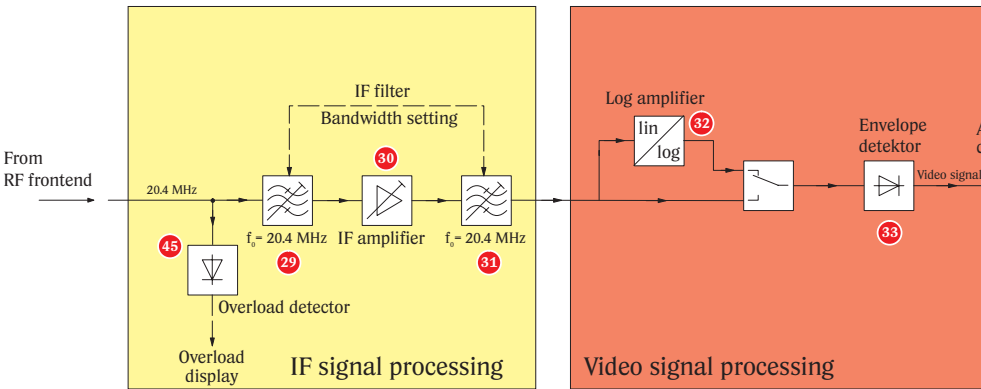
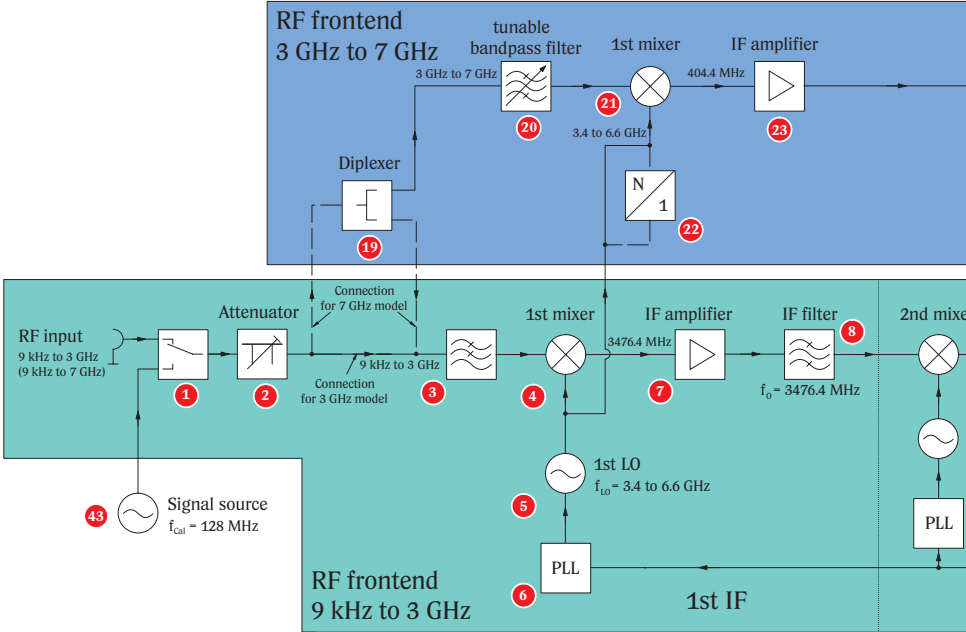

PRACTICAL REALIZATION OF AN ANALYZER

