



For more Hi-Fi manuals and set-up information
please visit www.hifiengine.com

QUAD

99

Pre-Amplifier, Compact Disc Player, FM Tuner
and Remote Control

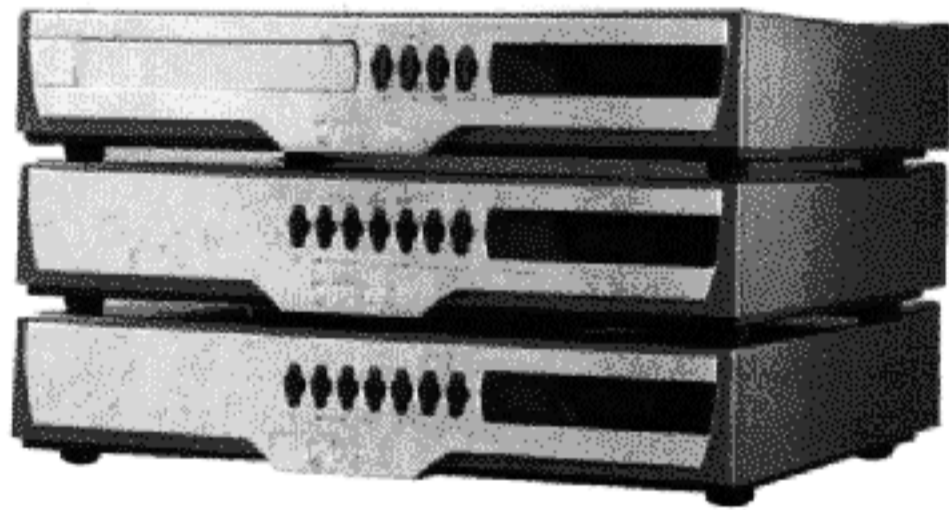

Instruction Manual

QUAD

99

Pre-Amplifier, Compact Disc Player, FM Tuner and Remote Control Instruction Manual

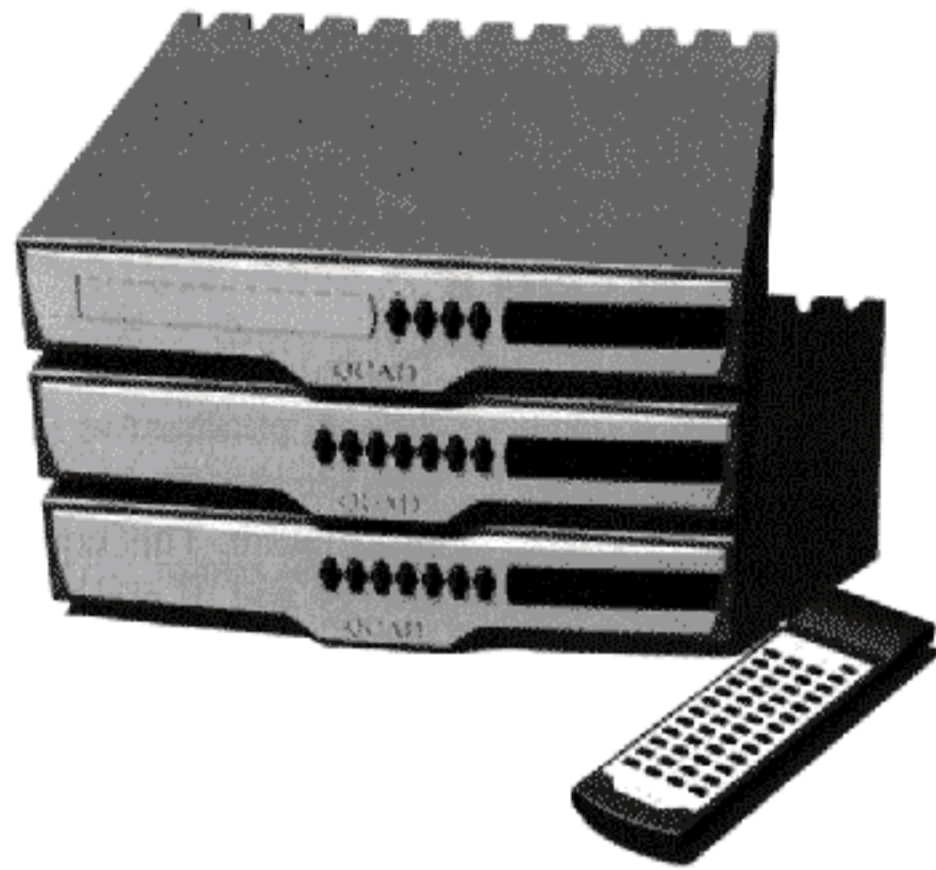

CONTENTS

INTRODUCTION	3
PACKING LIST AND UNPACKING THE EQUIPMENT	3
GUARANTEE AND PRODUCT REGISTRATION	4
SERVICE ARRANGEMENTS	4
ACCESSORIES	4
CARE & CLEANING	4
SAFETY AND OPERATION OF ELECTRICAL PRODUCTS	5
INSTALLATION OF THE 99 SERIES EQUIPMENT	7
OPERATION	
99 PRE-AMPLIFIER	9
REMOTE CONTROL	13
99 COMPACT DISC PLAYER	16
99 FM TUNER	18
TROUBLESHOOTING	22
SPECIFICATIONS	25

IMPORTANT NOTES

European Union Directives

Quad equipment is designed to comply with the legal provisions of EU Directives 89/336/EC and 72/23/EEC. The standards which have been applied were those in force at the time of the introduction of the product.

The product bears the CE mark: 

Compliance cannot guarantee perfect performance. In the very rare circumstance that you experience problems you should first try to locate and remedy the origin of any disturbance. A further option is to relocate the Quad equipment in order to reduce the interference. Your dealer should be able to provide assistance if the problem persists.

FCC Rule 15 Class B

This equipment has been tested and complies with the limits for a Class B device, pursuant to Part 15 of the FCC Rules. These limits are designed to provide reasonable protection against harmful interference in a residential installation. This equipment generates, uses and can radiate radio frequency energy and, if not installed and used in accordance with the instructions, may cause harmful interference to radio communications. However, there is no guarantee that interference will not occur in a particular installation. If this equipment does cause interference to radio or television reception, which can be determined by turning the equipment off and on, the user is encouraged to try to correct the interference by one or more of the following measures:

- Re-orient or relocate the receiving antenna
- Increase the separation between the equipment and the receiver
- Connect the equipment into an outlet on a mains circuit different to that to which the receiver is attached
- Consult the dealer or an experienced radio/TV technician for help

This Class B apparatus meets all the requirements of the Canadian Interference Causing Equipment Regulations.

Information to the user

Alteration or modifications carried out without appropriate authorisation may invalidate the user's right to operate the equipment.

It is always good practice to switch off equipment before connecting or disconnecting signal leads. This will prevent unpleasant and loud noises coming from the loudspeakers and avoid the risk of damage to equipment.

This equipment is double insulated and does not need a safety earth. It is important, though, that any equipment connected to it is earthed according to the manufacturers' instructions. This becomes more important as the number of units which are connected together increases.

Noise Pollution

Please be aware that very high sound pressure levels can cause permanent damage to your hearing and also severe annoyance to neighbours.

INTRODUCTION

You should read the following useful notes before you begin to install and use the equipment. The notes are directed towards the responsible adult who is responsible for the safe installation of the equipment. You should not allow minors to attempt electrical installation or to carry out changes.

This equipment is intended to be used for music reproduction in the home and we hope that it will give you much pleasure. The Quad 99 series comprises a range of equipment which can be connected together using Quad's interlink system which we call QuadLink. Some products of the 99 series receive their power from the QuadLink bus. This power is provided by one of the special base units such as the 99 series preamplifier or the 99 series Audio Visual preamplifier. You can also provide your Quad 99 series equipment with signals from your existing equipment though you will not be able to control their functions with the 99 remote control.

PACKING LIST AND UNPACKING THE EQUIPMENT

The 99 Pre-Amplifier carton contains:

- 99 Pre-Amplifier
- 99 Remote Control
- One IEC mains lead fitted with an appropriate mains connector:
- *One 160mm long QuadLink terminated link cable, Q37414A*
- Instruction Manual
- Warranty Registration Form
- One set of packing materials

The CD Player carton contains:

- 99 CD Player
- One set of packing materials

The 99 FM Tuner carton contains:

- 99 FM Tuner
- One 160mm long QuadLink terminated link cable, Q37414A
- Instruction Manual
- Warranty Registration Form
- One set of packing materials

Consult the dealer from whom you purchased the equipment if any of these items are not present.

Please retain the packing materials for future use or return them to your dealer. If you decide not to keep the packing, please dispose of it sensibly. The paper and plastics components are recoverable and may be taken to an appropriate recovery service.

Please retain the user manual and the information concerning the date and place of purchase of this equipment for future reference.

GUARANTEE AND PRODUCT REGISTRATION

Your Quad equipment is guaranteed against any defect in material and workmanship for one year from the date of purchase (proof of purchase required). We ask you to complete and return the enclosed Warranty Registration Form. This will also enable us to keep you informed of future Quad products. Within the guarantee period, Quad will undertake replacement of defective parts free of charge provided that the failure was not caused by misuse, accident or negligence. Your statutory rights within the territory in which you purchased the equipment are not affected by this guarantee.

Quad carries out a regular review of its products and reserves the right to adjust the specifications and performance from time to time.

There are no user replaceable or serviceable parts inside this equipment. Unauthorised attempts to service or modify this product will invalidate the warranty.

SERVICE ARRANGEMENTS

If your Quad equipment requires servicing you should return it to the dealer from whom the equipment was purchased.

If you are abroad and there is no suitable dealer in your area, please contact the distributor for the country in which it was purchased or Quad Electroacoustics Ltd.

Equipment returned for service should use the original packing. You should enclose a brief note with your name and address and the reason for returning the equipment.

ACCESSORIES

This unit has the facility to work with other units such as a cassette tape recorder, video player or other hi-fi equipment. The following optional accessories are also available.

Accessory description	Part No.
IEC mains cable 2m, fitted with UK plug	QUKES2B
IEC mains cable 2m, fitted with European plug	QE2P2S2
QuadLink bus cable 160mm	Q37414A
QuadLink bus cable 1m	Q37404A
Double ended phono cable 500mm	QP2P2SA
Double ended phono cable 1m	QP2P21A
Double ended phono cable 2m	QP2P22A

Note: We do not supply loudspeaker cables terminated with 4mm plugs nor the 4mm plugs themselves.

CARE AND CLEANING

The surface of the equipment may be cleaned with a damp cloth provided that the power has been removed first. Solvent based cleaning materials

should not be used as they may damage the paint finish and the optical quality of the front panel windows.

SAFETY AND OPERATION OF ELECTRICAL PRODUCTS

All electrical products carry with them the risk of electrical shock if they are misused. Quad 99 series equipment is intended for use in a domestic environment.

It is important that all electrical connections are competently and securely made to the unit before power is applied. Access to the rear of the equipment should be protected by careful placement of the equipment. Bear in mind that the voltage from the output of the 99 series power amplifier can exceed 50V peak and that metal parts, such as loudspeaker connectors, must not be touchable while the equipment is powered.

Mains working voltage and fuse ratings

The rated voltage for this unit is marked on the rear panel. Please check with the dealer if you intend to use the equipment in regions which use different values of mains voltage.

Quad manufactures equipment to the following principal mains voltage requirements:

- Europe, including the UK, uses 230VAC
- Japan uses 100VAC
- USA, for example, uses 115VAC
- Korea, for example, uses 220VAC

If you are in any doubt what the correct operational voltage is you should ask a qualified electrician before applying power to the equipment. The Quad 99 pre-amplifier will work within standard tolerances of this voltage.

The mains supply fuse of the Quad 99 pre-amplifier is accessible on the rear panel when the IEC mains plug has been removed. In the rare event that it has broken, you should first check for any obvious cause before replacing the fuse with one of the correct rating and type. The correct fuse values are:

Country or region	Nominal mains voltage	Fuse rating
Europe including UK	230VAC	T1.0AL slow blow 5x20mm
Japan	100VAC	T2.0AL slow blow 5x20mm
Korea, for example	220VAC	T1.0AL slow blow 5x20mm
USA, for example	117VAC	T2.0AL slow blow 5x20mm

You should switch off the equipment and remove the connection to the mains power outlet before changing the fuse.

Mains Connections

The power supply input is via an IEC mains connector and an appropriate mains lead is supplied. A.C. Mains is fed back out via an unswitched IEC mains outlet to provide power to the power amp(s) to which the pre-amplifier is connected.

Quad equipment supplied in Europe is provided with a mains cable fitted with an appropriate mains plug. This plug should not be cut from the cable or used with its fuse cover removed. If, for any reason, the plug is removed, it must be safely disposed of. It must *never* be plugged into a mains socket.

Any replacement plug should be wired to the supplied mains cable as follows:

- the **BROWN** wire must be taken to the **LIVE** terminal
- the **BLUE** wire must be taken to the **NEUTRAL** terminal

In the UK a fused 13 Amp mains plug should be fitted with a fuse link rated to 13 Amp which conforms to BS1362. In other countries a value between 10 Amps and 15 Amps should be used at either the wall socket or at the mains distribution board.

When you are trimming or cutting cables and wires you should be careful to avoid the waste parts from falling onto or into any electrical equipment. If you are in any doubt you should consult a qualified electrical engineer.

Note: Only amplifiers that do not need to be earthed can be connected to this AC output. QUAD 606, 306, 405 and 303 amplifiers must be connected directly to an earthed AC outlet and not to the AC outlet on the QUAD 99 pre-amplifier. The total load on this outlet should not exceed 500w.

INSTALLATION OF THE QUAD 99 SERIES

Properly installed Quad equipment will allow you to enjoy its performance. There are a few simple requirements. Wherever you place the equipment, you should ensure that it is not at risk from spilled water, for example from plants and flowers, and that you are able to prevent small children and pets from gaining access to the cables and connections. The environment should be dry and free from rubbish. You should not place magnetically or thermally sensitive objects such as computer discs, credit cards, magnetic tapes and writable optical discs on the surface of the equipment as the combination of heat and magnetic field may be sufficient to corrupt the information stored on them.

To keep the bus connections simple, place the pre-amplifier underneath other QUAD 99 source products like CD and tuner, but above 99 stereo power amplifiers. Power amplifiers can be placed along side or out of sight using a long ampbus cable which is available as an accessory.

Use of correct connectors and cables

You should ensure that any cables which are used with Quad equipment are properly terminated and that the cable is appropriate to the task. This is particularly important with loudspeaker cables and connections. If you are in any doubt you should consult your dealer.

In order to connect the low level signals into the equipment, Quad 99 series uses RCA phono plugs at each end of a screened cable. Properly made cables will reduce the effects of interference and will ensure a connection which is free from added noise and distortion.

Connecting the 99 System

Before you connect the QUAD 99 pre-amplifier to the AC mains supply check that the voltage marked on the back matches the voltage of your supply.

QUAD 99 sources

Quad 99 CD player and Tuner are connected by the QUADLINK bus cable. The QUAD 99 preamplifier supplies power for up to three QUAD 99 bus powered products.

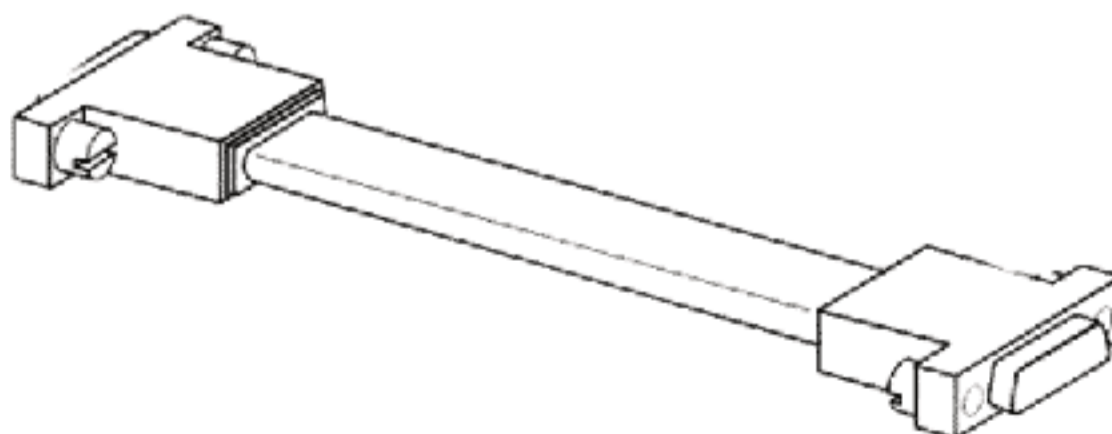

This shows the general view of a QuadLink cable. The ends are terminated with a male and female form of the D type 15 way connector. Quad manufactures two lengths of this cable, 160mm and 1m. The 99AmpBus cable is actually electrically and physically identical.

Other Sources

Other sources are connected to the appropriate inputs using suitable interconnect leads. A turntable should be connected to the Phono input and earthed (grounded) to the terminal next to the input. Input sensitivity can be altered from the remote control, so at this stage it is not necessary to worry about the output level of the various sources you are connecting.

There are two 15 way D type bus sockets. The top female connector links to the other units on the Quadlink bus. The 99 Pre-amplifier is a bus master product with facility to supply 30 Vac to the other Quad 99 source products on the bus. The bottom female connector is a dedicated bus, 99 AMPBUS, to link to any 99 series power amplifier.

Outputs

The output from the pre-amplifier is via a special bus, 99 AMPBUS, to link to a 99 series power amplifier. This output bus provides audio and standby control to switch the power amplifier on and off with the system. There is also an output to a non 99 Series power amplifier via two phono connectors (PRE-OUT). The output level is 775mV (rms).

These diagrams show some Quad 99 system components in typical arrangements. The bottom sketch shows the arrangement with a turntable connected to a 99 pre-amplifier. The top sketch shows how further Quad 99 series stereo power amplifiers can be used in a bi-amplified system

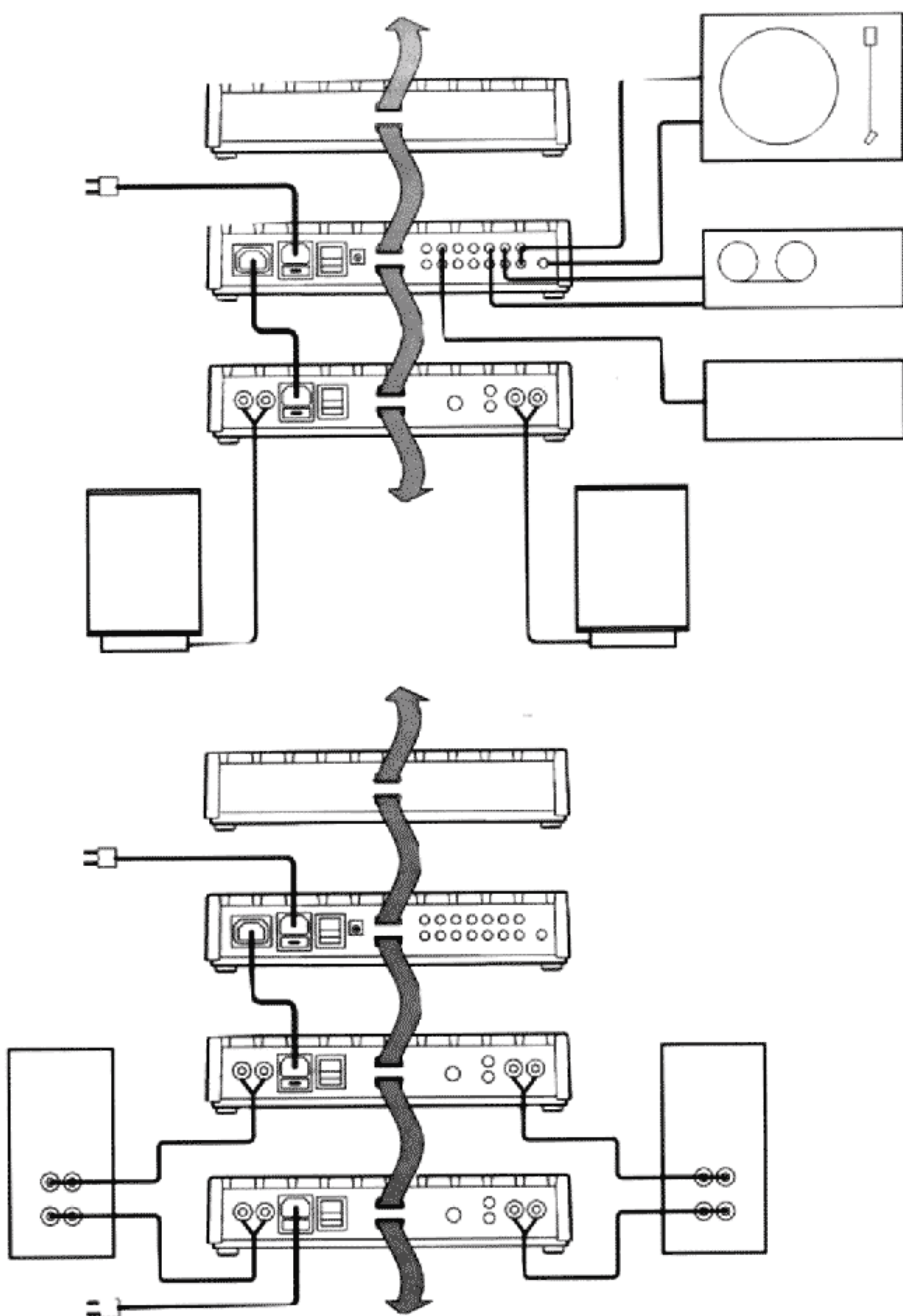

OPERATION

Introduction



99 PRE AMPLIFIER

The QUAD 99 pre-amplifier offers the highest possible performance combined with all the facilities which the serious audiophile needs. It can be used with any of the QUAD 99 series amplifiers or any other suitable amplifier. It can be operated either from the push buttons on the front panel or the QUAD 99 remote control. Some of the pre-amplifier functions can only be accessed from the remote control. The 99 pre-amplifier has inputs for three line level sources, one RIAA equalised phono input and a tape loop in addition to the those sources available on the Quadlink communications bus. This bus allows connection to other QUAD 99 'bus' sources. The QUAD 99 pre-amplifier has tone controls and a straight through bypass circuit. These can only be accessed from the remote control. The EQ section of the pre-amplifier has a low pass filter, a bass boost and cut and the QUAD 'tilt' control, pioneered on the QUAD 44 and incorporated on every QUAD pre-amplifier since.

The 99 pre-amplifier weighs approximately 4.42kg. It is built to be robust but you should be mindful of its weight when you carry it and place it down. Remember to check that any surface on which you place it is stable and is able to support its weight.

There are no user adjustable parts inside the equipment. You should refer any servicing to a qualified engineer or return the equipment to either the dealer or the Quad distributor.

On/Off Switch

The On/Off switch is on the rear panel. The pre-amplifier should normally be left switched on and just put into standby when not in use.

Front Panel Description and Functional Operation

The front panel has 7 push buttons. The display shows the number of the selected auxiliary source, if any, and the volume or balance setting.

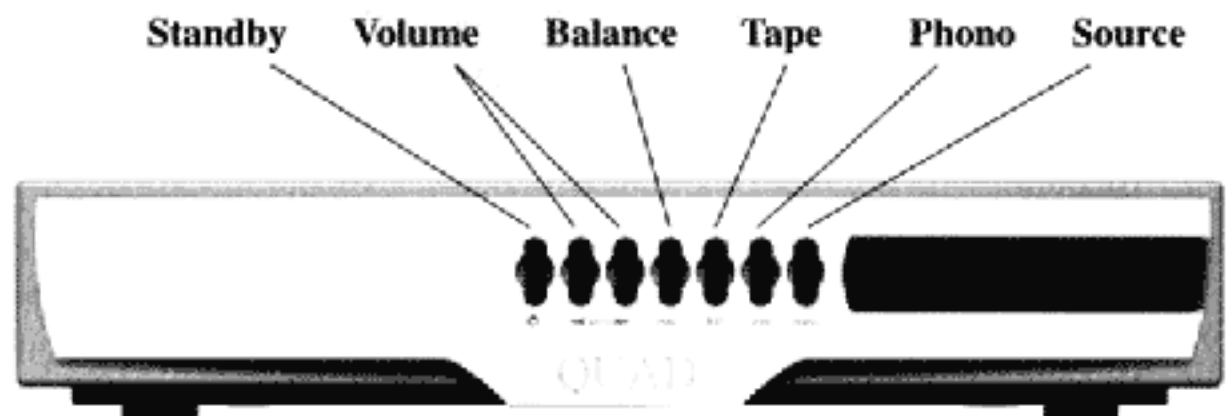

Standby

The standby button switches the unit (and all other 99 products) in and out of standby. The standby button glows green when the unit is active and red when it is in the standby mode.

Volume

The Volume buttons increase > and decrease< the volume level. Maximum volume is reached when the display reads "32". However, the volume should be reduced if the sound appears to be distorted.

Balance

To change the balance between the stereo channels press the Balance button once. Adjust balance using the volume control buttons. > adjust balance to the right, < adjusts the balance to the left.

Max RHC level	RI	6A-9
Centre position	RI	6A--
Max LHC level	RI	6A9-

After 3 to 4 seconds the display returns to show the volume level.

Tape

Pressing the tape button toggles the tape input on and off to allow tape playback or monitoring. The setting is shown on the display:

tape input selected	TP	on
source input selected	TP	off

The tape output is always connected to the source that has been selected.

Phono

The phono button selects the turntable (record player) input. When initially pressed the button displays either PL or PH, these being the moving coil (high sensitivity) or moving magnet (low sensitivity) cartridge settings. To change the setting hold down the Phono button for 5 seconds upon which the display will change to the other setting.

moving-magnet input selected	PH	00
------------------------------	----	----

Source

Pressing the source button sequentially scrolls the source selection through all inputs in the sequence: Phono, CD, Tuner, Aux 1, Aux2 and Aux 3.

CD player input selected	[d	00
--------------------------	----	----

Tone controls

The Quad 99 tone controls are an invaluable aid to improving imperfect recordings and have been carefully designed to help you overcome some of the more common problems, without adding colouration or distortion. There are no hard and fast rules about when and when not to use tone controls. If the recording or broadcast sounds less than realistic then do not be afraid to experiment.

You can always by-pass them by pressing EQ until the display is as shown in Figure 1 below.

All the tone controls can be operated simply using the buttons on the remote control handset. However, they can also be operated by pressing the front panel buttons in particular sequences. These are described below.

All the controls below can only be operated once the Equalisation function is enabled. This is done by pressing the Balance five times (until "EQ" is displayed) then pressing either Volume button to toggle the Equalisation on or off.

Equalisation off

Fig.1

[d EQ--

Equalisation on

Fig.2

[d EQon

Tilt Control

Tilt allows you to slope the entire frequency response about a central point. Press the left hand button to raise the bass and lower the treble and vice versa. There are six settings apart from flat. The effect is subtle but allows you to add warmth to an otherwise overbright recording or life to an otherwise dull recording without adding colouration. The graph shows the shape of the different settings:

Tilt filter responses

To operate the Tilt Control first press the Balance button two times then press the Volume Up button > to tilt upwards or the Volume Down button < to tilt downwards. The tilt control operates in three steps either up or down as shown on the response chart on page 12.

Maximum tilt up
Bass lifted, Treble cut

[d EL7]

Flat response no tilt

[d EL0]

Maximum tilt down
Bass cut, Treble lifted

[d EL3]

Bass Control

Bass has one position of boost and one of cut. You would use boost with a small moving coil loudspeaker and cut if the loudspeakers were placed in a corner or too close to the back wall of the listening room.

To operate the Bass control press the Balance button three times. Then the Volume up and down buttons can be used to select bass boost, bass cut, or a flat response .

Bass cut

[d b54-]

Flat response

[d b5--]

Bass boost

[d b5r-]

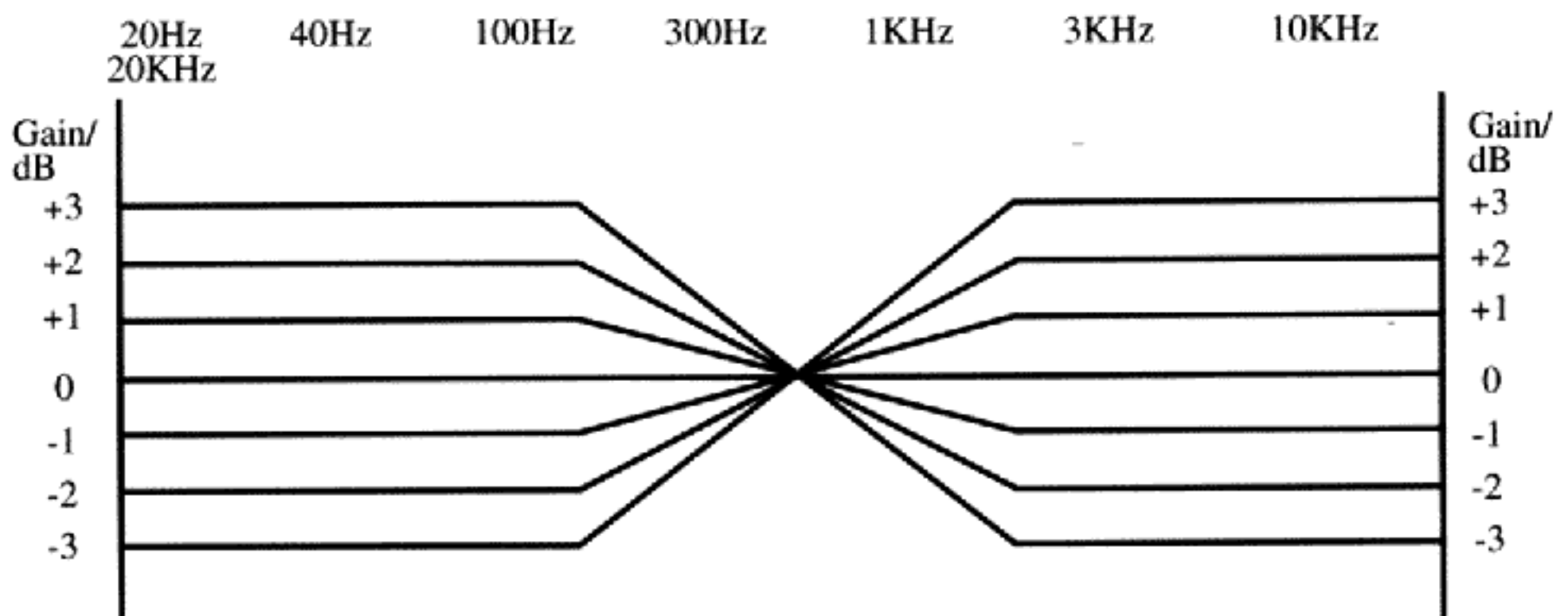
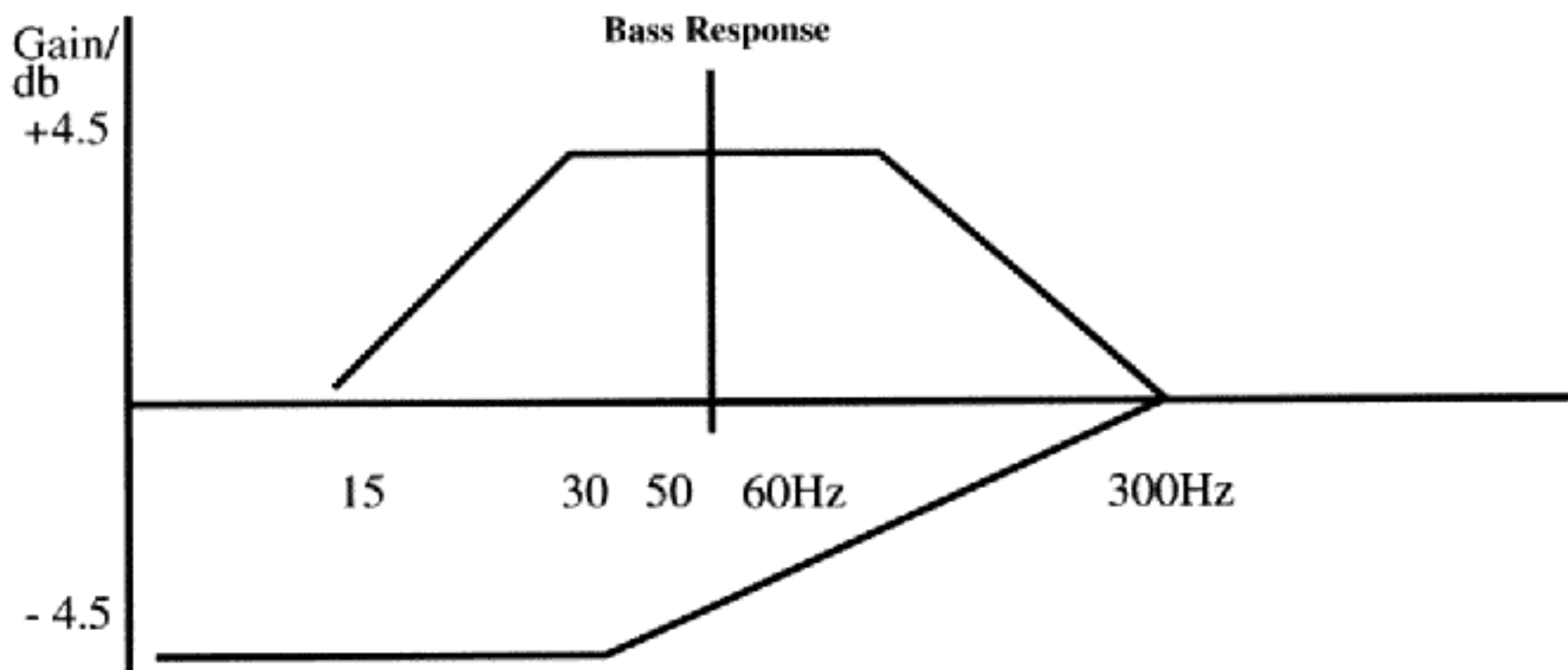

Filter Control

The phono input includes a permanent "rumble" filter. This has a response with a 3dB point at 5Hz and slope of 6dB/octave. The response of the two filters is shown combined (see Figure 1, foot of page). The scratch filter can be switched in to the signal path on any input.

To operate the Filter control press the Balance button four times. Then press either Volume button to toggle the filter on and off.

filter on

[d FLon

filter off

[d FL--

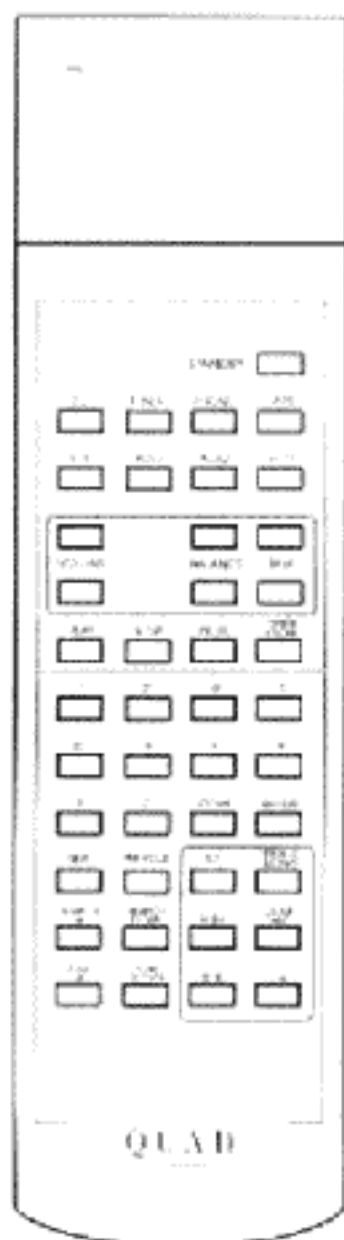

99 REMOTE CONTROL HANDSET

Most of the functions of the remote control handset duplicate the front panel controls and are obvious from the labelling of the buttons. However some of the functions follow particular sequences and these are described below.

General note

Many of the settings of the 99 Series system can be reviewed by pressing the relevant button on the handset. As a general rule the first press will reveal the current existing setting and a second press will change the setting.

Replacing batteries

When the operation of the handset becomes uncertain or when it becomes necessary to hold the handset close to the 99 Series Pre-Amplifier, it can be assumed that the batteries need replacement.

The batteries can be changed by opening the compartment cover on the rear of the handset. Always fit the new batteries in the correct alignment as printed inside the compartment and always fit the correct type of battery which are AAA size Alkaline cells.

The old batteries should be safely disposed of.

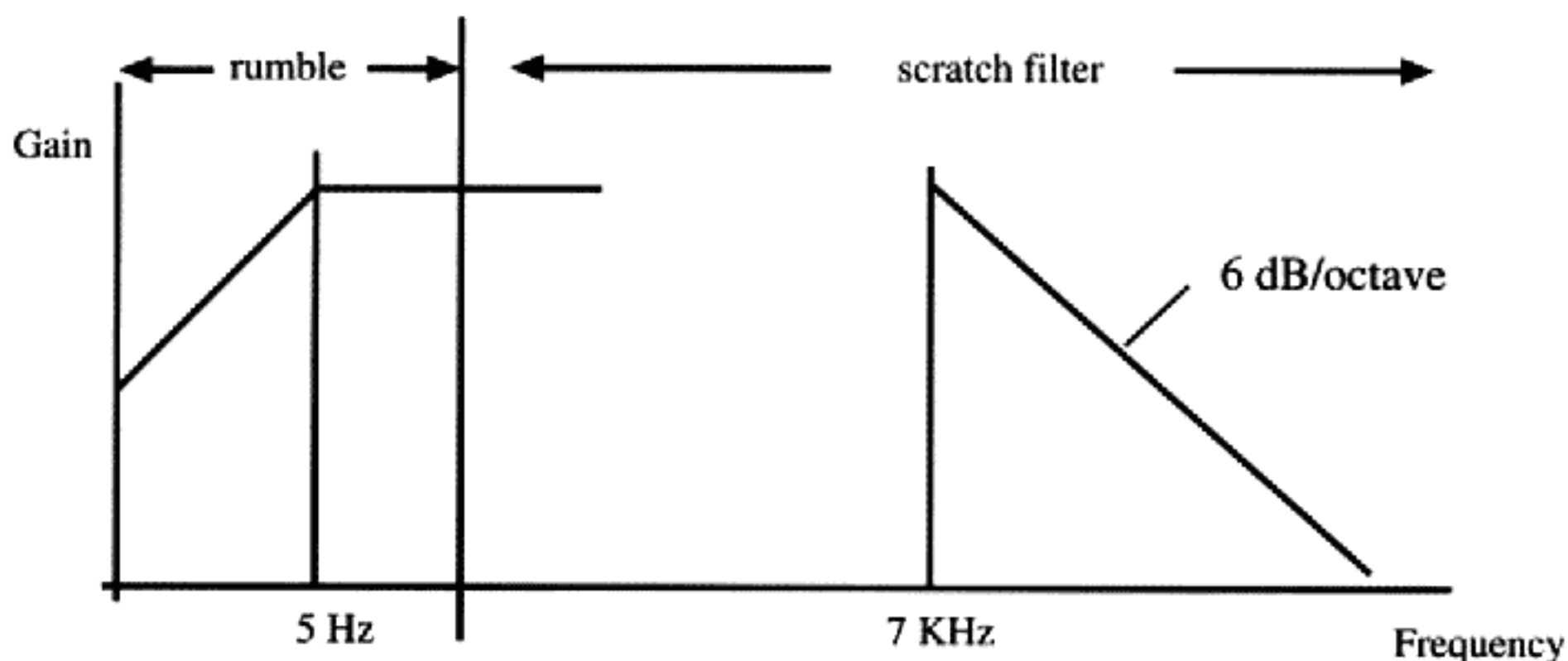
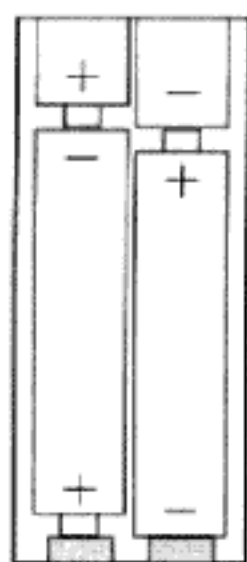

Figure 1

CD PLAYER FUNCTIONS

Track Selection

The first track can be selected on the numeric keyboard by pressing the button corresponding to the track number. If the track number is, say 23, press the '2' button and then the '3' button. If more than three seconds elapse after pressing the '2' button then the track will be read as 2 and not 23.

The selected track will be displayed and playback will start as soon as the PLAY button is pressed. The track can then be changed by pressing another number button or the NEXT or PREV buttons.

Tracks can be scanned by pressing the SEARCH UP or SEARCH DOWN buttons if you are trying to find a particular passage within a track.

Note that it is not possible to select track numbers higher than those on the disk.

Stored Track Selection

A combination of tracks from a disc can be stored by selecting the first track on the numeric keyboard (1 to 9) and then pressing the Store button; selecting the second track and pressing Store and so on. The display will then show the total number of tracks selected on the total playing time.

5 tracks stored;
total playing time of
11 minutes 53 seconds

05 1:53

The selection of stored tracks can be reviewed by pressing the NEXT or PREV buttons to scan up or down.

The stored tracks will begin to play once the PLAY button is pressed.

The stored programme can be cleared by pressing the STOP button rapidly twice in succession.

Pause Function

The playback of a track can be suspended by pressing the PAUSE button. When this is done the "remaining time" display will flash. If any CD function button (PAUSE, PLAY, NEXT etc) is then pressed the pause function will be released and the track will play again.

Repeat function

To continuously repeat the playback of an entire disc, first load the disc and then press REPEAT before pressing the PLAY button. At the end of the last track the player will return to the start of the first track and continue to play until the STOP button is pressed.

To continuously repeat a selection of tracks first store a track selection (see under Stored Track Selection) then press the REPEAT button before pressing the PLAY button.

The repeat function will be switched off whenever the STOP button is pressed.

FM TUNER FUNCTIONS

Station Selection

Any of the 25 preset stations can be selected by pressing buttons on the numeric keypad. If presets 1 or 2 are selected there will be a short delay of about 3 seconds before the station is selected. This is to allow you time to press a second numeric button to select, say, preset 15 or 25.

Stations can be stored in memory by selecting a preset number; then finding the desired station using the SEARCH or TUNE buttons then pressing the STORE button.

The preset stations can also be reviewed using the NEXT and PREV buttons to step through the stations one by one.

Pre-Amplifier Functions

Preset Input Sensitivity

The sensitivity of the Auxiliary; Tape and Phone inputs can be adjusted from the remote control handset.

Select the desired Auxiliary input and then press the SENS button. Each time the SENS button is pressed the input sensitivity will step through one of three values; 775mV; 300mV and 100mV. Any of these values can be selected. Note that the first time the SENS button is pressed the current setting will be shown. The second time the button is pressed the setting will change.

This useful feature allows settings to be conveniently checked at any time.

The Phono input sensitivity can be adjusted in a similar way. This input is set to either moving -magnet (PL) compatibility or moving-coil (PH) using the front panel control (see page 9). The possible settings are then

PL 1mV; 3mV; 7.75mV (displayed as 1.00, 3.00 and 7.75)

PH 100uV; 300uV; 775uV (displayed as .100, .300, .775)

The Tape input sensitivity is set by first selecting the Tape input then pressing the SENS button and toggling through the three values which correspond to sensitivities of 100mV, 300mV and 775mV.

Mute Function

When the MUTE button is pressed the sound is muted to virtual silence and volume level display flashes with the current setting . Pressing the MUTE buttons again or pressing the VOLUME; BALANCE; BASS; TILT; FILTER; EQ will remove the mute and return to normal operation.

Tilt tone control functions

This control works in the same way as the front panel control but with a single button it is necessary to step through each setting in sequence until the desired setting is reached.

99 COMPACT DISC PLAYER

Installation

The 99 CD player can be free-standing or stacked with other components. The player must be horizontal and must not be placed in direct sunlight or near any heat source.

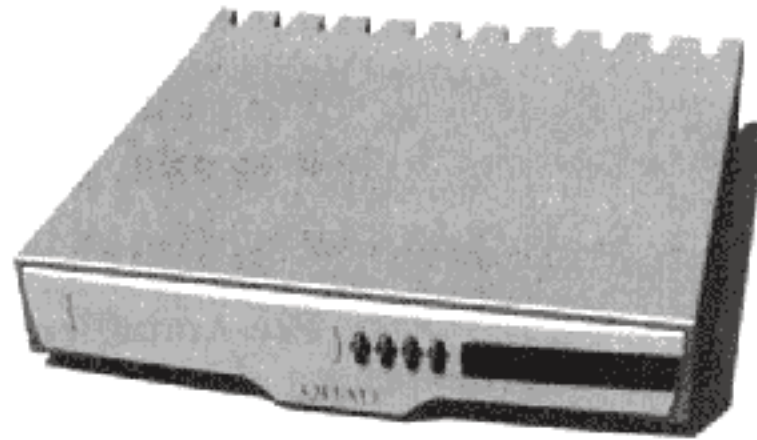

Connecting the 99 CD Player

Before connecting the 99 CD player, you must first put the 99 pre-amplifier into standby and switch it off. The 99 CD player can then be connected via a Quadlink lead between the two units. When the amplifier is switched on, the standby buttons on both units will glow red to show that the system is powered up and ready for operation.

Operation

The 99 CD player can be operated from the front panel or by the remote control.

Front Panel Operation

The four buttons are (from left to right): standby; track next and previous; play and stop; and disc.

Button	Function
<i>Standby</i>	Toggles between activating or deactivating the 99 CD player. (NB. The standby button on any unit controls the whole system)
<i>Track Next and Previous</i>	Selects the next or the previous track.
<i>Play and Stop</i>	Toggles between playing a disc and stopping the disc.
<i>Disc</i>	Toggles between opening and closing the disc drawer.

To load a disc, first press the STANDBY button on the front panel. The standby button will go from red to green. Press the disc button to open the drawer and then load a disc. Press disc again to close the drawer. The player will read the disc's Table of Contents (TOC) and display the number of tracks and total playing time.

Press **PLAY** to start the disc playing and the play LED will glow green. While the disc is playing, the front panel will display the track number and the time remaining.

To select a different track, use the **TRACK NEXT** and **PREVIOUS** button. This has a rocker action. Press the top to go forward, and the bottom to go back. When the disc is playing, the **PLAY** button becomes the **STOP** button – press it to stop the disc playing.

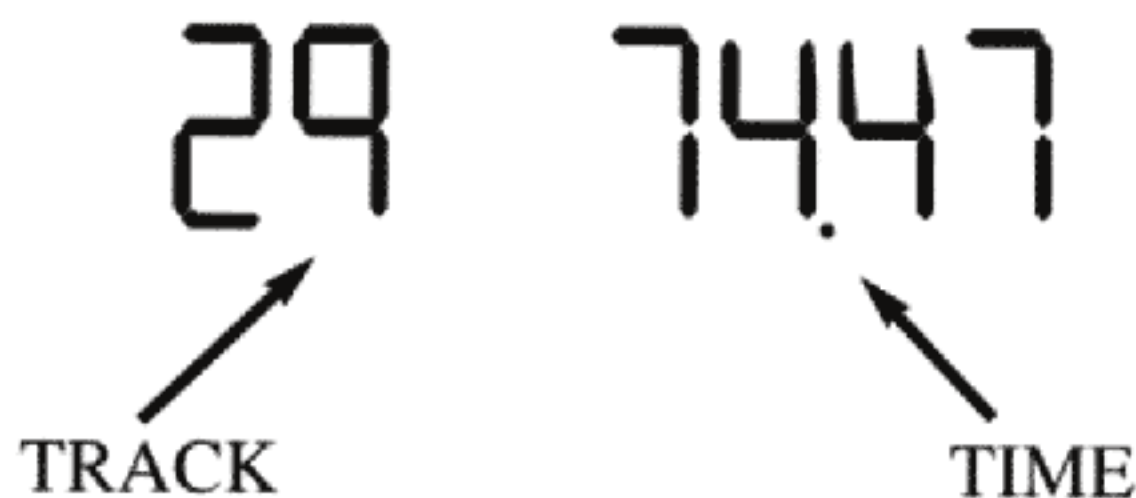

99 FM TUNER

Connecting the FM Tuner

Use the Quadlink cable to connect the 99 FM Tuner to the rest of the Quad 99 system.

Aerial Connection

There are two FM 75Ω co-axial sockets on the rear panel for aerial or cable signals. It is a truism that the performance of your aerial is the performance of your tuner. For best results, you should use a professionally installed multi-element FM aerial mounted on the roof, or at least in the loft space. If you are very close to a transmitter, you may be able to get acceptable results from an indoor aerial, but reception could be noisy and distorted, particularly in stereo. If you plug a normal aerial into the cable input, you will lose much of your signal strength.

The cable input is so described because cable and satellite operators often offer FM radio channels. Its input sensitivity is specially tailored to accept signal levels from such service providers. Plugging a cable feed into the FM 99 aerial input may cause input overload and consequent distortion.

External Signal Connections

There is a line level phono output available for direct connection to the input of a DAT or tape recorder.

Operation

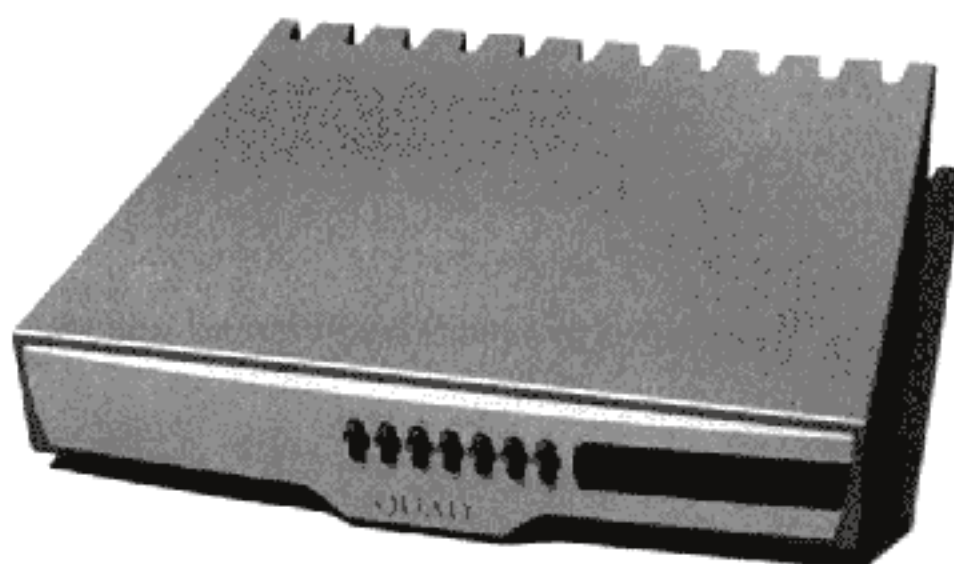

The front panel has 7 push buttons. The standby, cable, preset and mono buttons each have an LED indicator.

Starting Up

When the mains supply to the connected pre amplifier is switched on and the 99 FM tuner is in standby, the light on the standby button will be illuminated red. By pressing this button, the standby light will change to green and the front panel display will be illuminated. The 99 FM Tuner will now be operational.

Selecting an aerial input

When the normal aerial input on the rear panel is selected, the light on the cable button is extinguished. Pressing the cable button will illuminate the button, disconnect the normal aerial and replace it with the one connected to the cable input on the rear panel.

Tuning Indicator

The tuning indicator gives you an idea of a station's signal strength. When one light is on, the signal will be barely usable and stereo will be noisy. With all four lights lit, stereo and mono reception should be excellent. National stations often broadcast to different areas on frequencies quite close to each other. If reception conditions of a main national station are worse than you might expect, you could be tuned into a broadcast intended for another area. It is advisable to check the broadcast frequencies applicable to your location.

Tuning a station

The TUNE buttons can be used to tune stations manually or automatically.

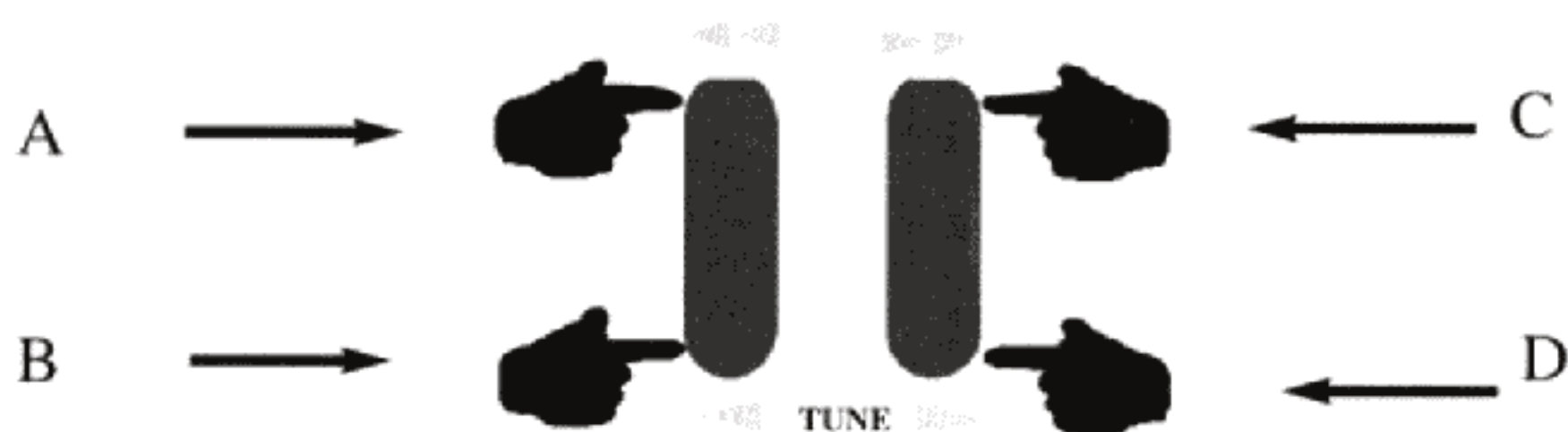

A- Press here to tune stations automatically in decreasing frequencies.

B- Press here to tune stations manually in decreasing frequencies.

C- Press here to tune stations automatically in increasing frequencies.

D- Press here to tune stations manually in increasing frequencies.

Manual Tuning

The Quad 99 FM Tuner scans the FM bands in steps of 50kHz. Press a button once at the points indicated and the tuner will advance 50kHz. Press it again and it will advance another 50 kHz. Clearly, if one wants to get between two widely spaced frequencies, using this process becomes rather tedious. If you press the button and keep it pressed the scan will speed up. As soon as you take your finger off the button the scan will stop.

Auto Tuning

Press the button at the points indicated and the tuner will scan the band until a station with usable strength is detected. The tuner will then tune the station and proceed to play. Another press of the button will repeat the process.

To stop the auto scan, press the lower part of the left-hand tune button once.

***Note:** Very weak stations may be below the level that the auto sensor in the 99 FM Tuner will accept. Such stations will have to be tuned manually.*

Tuning and Signal Displays

Station frequencies are displayed in MHz. As the 99FM scans in 50Hz steps, the final dot indicates when the frequency is 50kHz over that displayed: (i.e 95.65 MHz is shown as 95.6.).

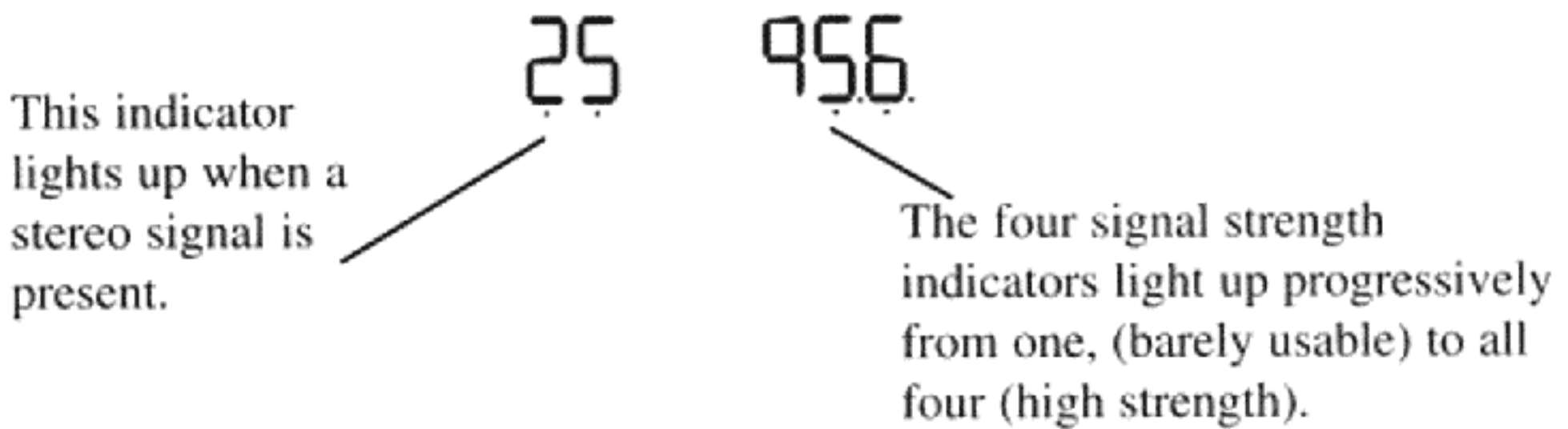

Mono or Stereo?

Normally, stereo reception is always preferable to mono. However, as the signal strength required for adequate stereo reception is many times greater than mono, weaker stations are apt to be noisy in stereo. In such circumstances putting the 99 FM into mono will greatly reduce background noise.

Pressing the MONO button will force the 99 FM into mono, and extinguish the stereo indicator. The indicator on the MONO button will also light.

Note: If the light is off on both the MONO button and the stereo beacon, the station is broadcasting mono. Operating the MONO button will have no effect.

Presets

There are 25 presets available. You may use a preset to store a station's frequency. Additionally, in the case of a station with marginal signal, you can store it both in mono and in stereo using different presets.

Storing a station

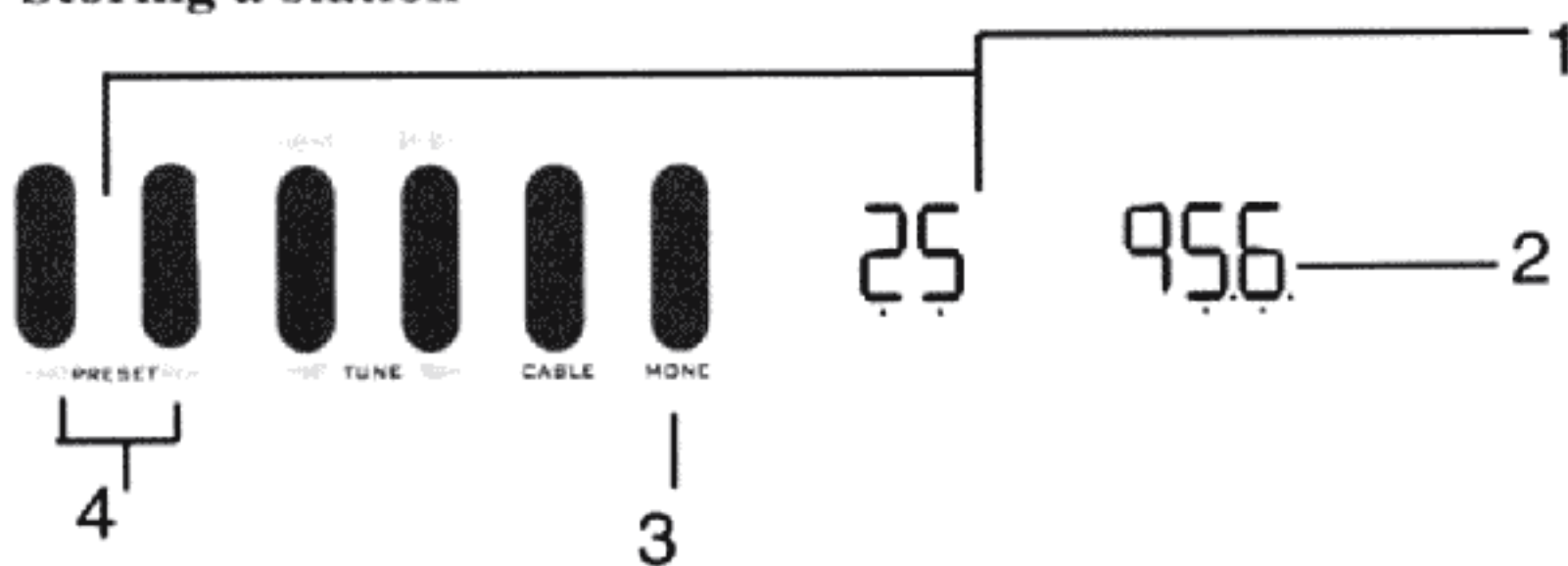

- 1) Select a Preset Number using the PRESET buttons
- 2) Tune in to the wanted station
- 3) Select Mono/Stereo
- 4) Press and hold down one PRESET button

The display will flash dashes alternating with the frequency

- 5) After four flashes the display will change to:

25 PSEt

- 6) Release the button

25 95.6.

The preset is now stored.

You may change the frequency stored in a preset by repeating the process using a new frequency, but you must keep the operating sequence the same.

TROUBLESHOOTING 99 FM TUNER

If you suspect that your 99 FM tuner is not operating properly, here are a few simple checks you should carry out before returning the unit to your dealer.

- **No front panel lights on at all**

Is the pre-amplifier switched on and working?

Is the Quadlink cable properly connected? (see page 7)

Have you connected the Quadlink cable to the AMPBUS socket on the pre-amplifier?

- **The 99 FM will not tune to any station in SEARCH mode**

Is the cable/antenna switch correctly set?

Make sure that your aerial is connected to the appropriate socket and that you can tune a station manually

- **All stations have high background noise**

If your aerial has been satisfactory hitherto, you may have a faulty connection or a cable fault.

Check that you are not using a conventional aerial plugged into the cable socket.

- **Mono reception is OK but stereo is noisy**

Your aerial is inadequate, or has become misaligned.

Paradoxically, the larger your antenna array, the more directional it becomes, so some stations that are off beam may be noisier than you would expect.

The station may be too distant for acceptable stereo reception

You may be experiencing interference from electrical or electronic devices such as computers. Try disconnecting the suspect apparatus from the mains and re-check reception.

- **No Stereo Indication**

Check that the indicator works properly with other stations. The station you are listening to may be broadcasting mono.

General Advice

When troubleshooting a suspected malfunction in the operation of your tuner, it is advisable to conduct all the operations from the front panel. This will narrow down the possibilities greatly.

TROUBLESHOOTING 99 PRE AMPLIFIER

- **There is no STANDBY or other light when the power is applied**

The mains outlet switch is not turned on

There is no power available from the mains socket

The mains cable is faulty

The IEC plug has not been pushed in firmly enough.

The rear panel fuse has blown

The front panel printed circuit board has failed.

- **The equipment front panel operates OK but there is no signal from the loudspeakers.**

Note: before adjusting and checking cables you should ensure that the volume control is at a low setting.

There is no mains supply to the amplifier.

The signal cable from 99 pre amplifier to power amplifier is faulty.

The connection between the power amplifier and loudspeaker are faulty.

The signal cables have not been properly pushed into the sockets at each end.

The CD you were playing has finished.

There is no audio input signal for the source you have selected.

The loudspeakers have been damaged.

The Quadlink and 99 AmpBus connections have been poorly made.

- **The front panel controls do not operate**

(If this happens, first of all try turning the complete system off for a few minutes, then try again, in case a communication error has occurred).

The front panel printed circuit board has failed.

- **The fuse blows each time the 99 preamplifier is turned on.**

The incorrect fuse value has been used

The unit is being supplied with the wrong mains voltage

The QuadLink bus or, or equipment attached to it, is faulty

There is an internal fault.

SPECIFICATIONS - 99 PRE AMPLIFIER

Aux. & Tape Inputs

Sensitivity	100,300 or 775mV
Signal-to-Noise Ratio	>97dB(A) ref 775mV
Distortion	<0.002%

Phono Inputs MM (MC)

Sensitivity	1,3,or 7.75mV (100,300 or 775uV)
Signal to Noise Ratio	78dB(A) ref 7.75mV (775uV)
Distortion	<0.05% (0.01%)

Pre Amp Output

Level	775mV (3.3volts maximum)
Source Impedance	100 ohms

AMPBUS Output

Level	2 volts (8 volts maximum)
Source Impedance	20 Ohms

Tape Output

Level	100, 300, 775mV (10 volts maximum)
Source Impedance	330 Ohms

Frequency Response

All inputs except MM & MC	10Hz to 20kHz	+0DB/-0.3dB
	3Hz to 56kHz	+0dB/-3dB
MM & MC inputs	20Hz to 20kHz	+/- 0.5dB
	7Hz to 53kHz	+0.5dB/-3dB

Dimensions (HxWxD) 70mm x 321mm x 310mm

Weight 4.42Kgs

The following abbreviations are used:

RIAA Recording Industry Association of America

MM Moving magnet cartridge

MC Moving coil cartridge

QUAD

Quad Electroacoustics Limited

LAG House

Sovereign Court

Ermine Business Park

Huntingdon

Cambs PE18 6WA

Sales

Telephone: 01480 433777 / 447700

Fax: 01480 431767

Service

Telephone: 01480 452561

Fax: 01480 413403

e-mail:

info@quad-hifi.co.uk

Quad is a member of the International Audio Group.

Quad is a Registered Trade Mark.