

The logo features the word "MAC" in a large, bold, black, italicized sans-serif font. A thick, gold-colored wavy line starts under the "M", curves under the "A" and "C", and then rises to underline the number "1700". The number "1700" is in a smaller, bold, black, italicized sans-serif font.

MAC 1700

STEREO RECEIVER

thank
you

To insure your enjoyment please read and carefully follow these instructions. The time spent will make it possible for you to enjoy thousands of hours of musical enjoyment.

If you are in a hurry read page 4 first. This gives you a brief outline of what each control and indicator does. Reading time for this manual is 30 minutes. This is time well spent.

CONTENTS

GENERAL DESCRIPTION	1
SPECIFICATIONS	3
IF YOU ARE IN A HURRY.....	4
CABINET INSTALLATION	5
INSTALLATION-CONNECTIONS	7
COMPLETE SYSTEM HOOK-UP.....	9
BLOCK DIAGRAM	10
FRONT PANEL INFORMATION.....	12
BALANCING YOUR SYSTEM	15
ENJOYING YOUR SYSTEM	16
GUARANTEE	Cover

GENERAL DESCRIPTION MAC 1700

The MAC 1700 is a stereo receiver. There are three easy to use top notch stereo components in one small convenient package. A solid state preamplifier, a solid state power amplifier, and an FM MPX stereo tuner are combined to give you the best performance possible. The result is a compact, easy to use stereo instrument. A stereo instrument that brings you the best in all types of stereo listening.

PROFESSIONAL STEREO PREAMPLIFIER

The stereo solid state preamplifier in the MAC 1700 gives you professional control of your listening. Bass and treble controls have 18db of boost and cut. This means you can control how your speakers will sound in your listening room.

A loudness control allows you to listen to music at low listening levels and still hear the full rich sound of music. There is a filter which lets you minimize noise and rumble from program sources. A tape monitor switch lets you monitor recordings in progress. But the prime function of a preamplifier is to reproduce records and tapes with full accuracy and sonic realism. Your MAC 1700 does recreate music from records and tapes with a degree of accuracy thought impossible a few short years ago. Records and tapes are made with the bass frequencies cut and the highs boosted. This allows more musical information to be put on the record or tape. The MAC 1700 reintroduces the bass and the highs following accurate and definite standards. Your records and tapes sound alive and thrilling when you hear them through your MAC 1700. Sixteen silicon planar transistors are used in the preamplifier. Silicon planar transistors are used because of their high thermal stability, low noise, and superior high frequency response.

POWER AMPLIFIER

Your MAC 1700 delivers 40 watts of power with both channels operating. This is 40 watts of steady state power. Your MAC 1700 delivers 40 watts of power hours on end. Distortion at 40 watts is less than $\frac{1}{4}$ of 1 % at any frequency from 30 to 20,000 cps. These measurements are made by testing sine wave power. A sine wave signal is fed into the amplifier at a voltage sufficient to drive the amplifier at rated power output. Then distortion is measured at full rated power with both channels operating into an impedance of 8 ohms. Distortion must be less than $\frac{1}{4}$ of 1 % from 30 to 20,000 cps. Only then is your MAC 1700 ready for you. At less than full power distortion becomes so small it can be measured by only the most sophisticated laboratory instruments. Only McIntosh gives you this kind of performance.

The MAC 1700 gives you a 2.5 microvolt FM stereo tuner. This sensitive tuner brings you clear, noise-free reception from distant stations. The tuner section is a superb product of pride of craftsmanship. In a tuner

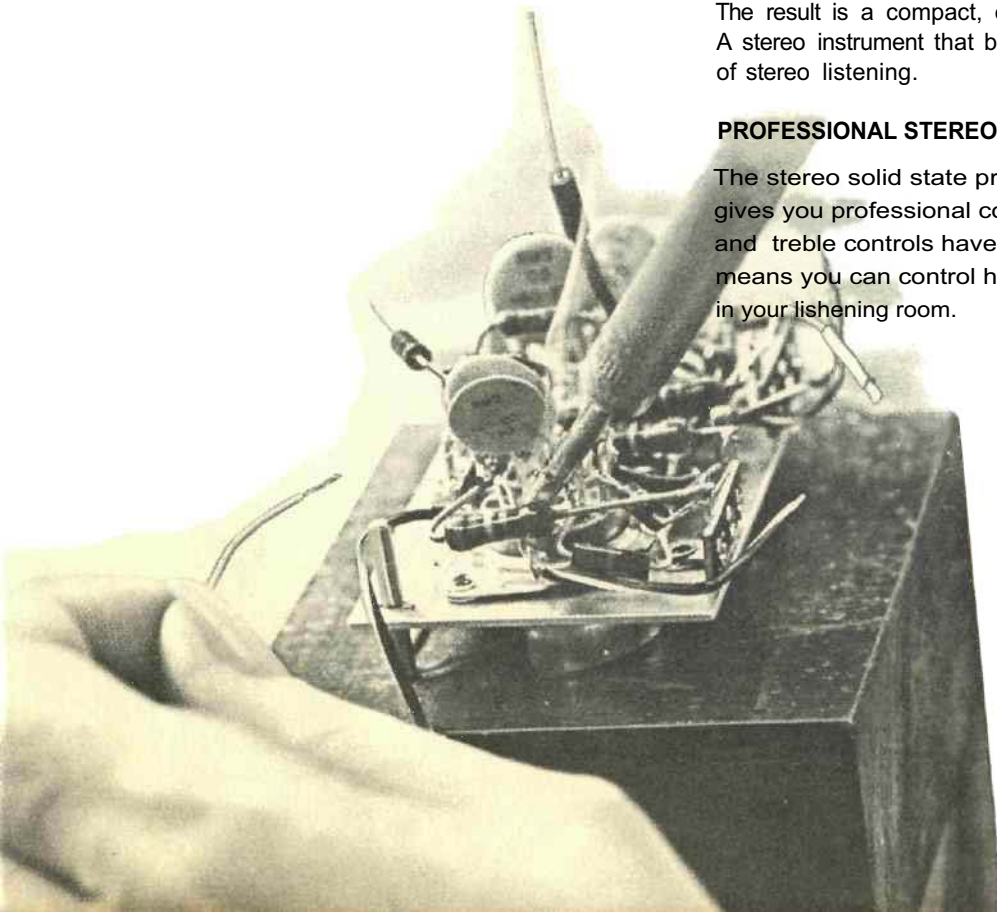



each wire must be placed correctly, each lead must be the precise length and each capacitor must be in an exact position. So each wire, each capacitor, each lead is checked and rechecked for maximum performance. This assures you of the best possible FM stereo reception.

The tuner section uses six tubes and two transistors. Tubes as RF amplifiers still give maximum sensitivity with the greatest overload protection.

The MPX section of the MAC 1700 uses 2 transistors and two tubes. In test after test this particular MPX section out-performed all other designs. The channel separation of the MPX section is better than the channel separation found with most phono cartridges. The distortion of the MPX section is less than what the FCC requires FM stations to maintain. You will hear all there is to hear from stereo broadcasts.

SPECIAL FEATURES

A power output monitoring circuit prevents failure of

the power output transistors due to a speaker short circuit, open circuit, or incorrect low impedance.

All transistors have a safe power dissipation area. This area is called the "safe operating area." If a transistor dissipates power beyond its "safe operating area" it destroys itself. Your MAC 1700 has a power output monitoring circuit that prevents the output transistors from exceeding their "safe operating area." When your MAC 1700 operates normally the power monitoring circuit has no effect on signals going through the power amplifier. If, however, the power dissipation in the output transistors becomes excessive due to speaker short circuit, open circuit, or a very low impedance load, the monitor transistors sense this through sampling devices in the output circuit. The monitor transistors restrict the drive to the output transistors. The restricting operation of the power monitoring circuit is immediate for any input signal or load combination. This arrangement assures complete circuit reliability for all load conditions. The monitoring circuit provides an extra margin of protection for your MAC 1700. The monitoring circuit prevents failure of the power output transistors due to short circuit, open circuit, or incorrect low impedance load.

The power transistors are mounted on oversized anodized heat sinks. The heat sinks assure a low temperature for operation of the transistors. If temperatures increase due to a shorted speaker, or restricted ventilation then an automatic temperature switch turns off your MAC 1700. The switch will turn your MAC 1700 on again when the temperature has decreased to a value suitable for normal operation. This additional feature gives your MAC 1700 reliability under the most extreme operating conditions. The power transistors used in the output section of your MAC 1700 are selected for their high power dissipation capability, wide frequency response, and large "safe operating area." In addition, each power transistor is given four separate tests before it is put in your MAC 1700. This additional testing assures you of full rated power from 30 to 20,000 cps.

Now sit back and relax with the knowledge you have "THE BEST."

TECHNICAL FEATURES AND SPECIFICATIONS FOR MAC 1700

FM TUNER SECTION:

USEABLE SENSITIVITY (at 100% Modulation: 2.5 μ V [I.H.F. Standards])

SIGNAL TO NOISE AND HUM RATIO: 65db.

HARMONIC DISTORTION: Mono, less than .5%
Stereo, less than .8%

DRIFT: Less than 25KC

FREQUENCY RESPONSE: Flat from 20 cps to 20KC with standard 75 μ second de-emphasis and 19KC pilot frequency filter.

CAPTURE RATIO: Better than 2.0db.

IMAGE REJECTION: Better than 60db.

STEREO MULTIPLEX SEPARATION: Better than 30db at 1KC.

SPECIAL FEATURES:

- A) Automatic stereo switching.
- B) Muting; IF injected circuit with at least 50db quieting between stations.
- C) Antenna inputs for 300 ohm balanced (for twin lead) and 75 ohm unbalanced (for coaxial cable).
- D) Nuvistor RF amplifier, Nuvistor mixer.
- E) Four stages of IF amplification, with AGC used to insure limiting occurs only in the limiter stages.
- F) Two limiter stages used for exceptional capture ratio and smooth muting operation.
- G) Multiplex filter and SCA filter, to suppress 19KC and 38KC signal components at least 40db below program and to suppress 67KC SCA by 60db.
- H) Noise rejecting logic circuit used to activate MPX stereo light and automatic stereo switching on 19KC stereo pilot only.
- I) D'Arsonval tuning meter for accurate center of channel tuning.
- J) Flywheel tuning for ease of operation and precise tuning.

AMPLIFIER SECTION:

POWER OUTPUT:

40 watts RMS continuous per channel with both channels operating simultaneously into 4 ohm or 8 ohm loads.

80 watts RMS continuous monophonic.

30 watts RMS continuous per channel with both channels operating simultaneously into 16 ohm loads.

60 watts RMS continuous monophonic.

HARMONIC DISTORTION: Less than 0.25% at rated power output from 30 cps to 20KC with both channels operating.

INTERMODULATION DISTORTION: Less than 0.25% for any combination of frequencies from 30 cps to 20KC if instantaneous peak power is 80 watts per channel or less into 4 or 8 ohm loads and 60 watts per channel or less into 16 ohm loads with both channels operating.

FREQUENCY RANGE: At rated output both channels: ± 0.5 db 20 cycles through 20,000 cycles.
+ 0, - 3db 10 cycles through 80,000 cycles.

OUTPUT IMPEDANCE: 4 ohms, 8 ohms, 16 ohms, no impedance switching required.

INTERNAL IMPEDANCE DAMPING: Less than .04 ohms; damping factor greater than 100.

INPUT SENSITIVITY AND IMPEDANCE: Auxiliary, Tape, Tuner, and Tape Monitor; 300 MV, 250K ohms.

PHONO 1 AND PHONO 2: 2.4 MV, 47,000 ohms.

TAPE HEAD: 2.4 MV, 1/2 megohm.

TOTAL NOISE (Including Power Amplifier):
High Level Inputs: 75db below rated output.
Low Level Inputs: 76db below 10 MV input; equivalent to less than 1.5 microvolts at input.

POWER AMPLIFIER: 90db below rated output.

TAPE OUTPUT: Tuner 1.5 volts, other inputs 300 MV at rated sensitivity, 1.3 volts with 1.0 MV at phono input.

BASS CONTROLS: ± 1 8db at 20 cycles, with friction clutch for independent adjustment for each channel.

TREBLE CONTROLS: ± 1 8db at 20,000 cycles with friction clutch for independent adjustment of each channel.

TAPE MONITOR SWITCH: Normal or Tape Monitor, indicator lamp lights in "Monitor" position.

SPEAKER SWITCH: Speakers ON or OFF for headphone listening.

FILTER: Flat or 5,000 cycle and 60 cycle cutoff at 12db per octave.

LOUDNESS SWITCH: Normal or compensated.

HEADPHONE JACK: For low impedance stereo headphones.

INPUT SELECTOR: 6 positions; AUX, TAPE, TUNER, PHONO 1, PHONO 2, TAPE HD.

MODE SELECTOR: Two positions; Mono-Stereo

SEMICONDUCTOR COMPLEMENT:

Preamplifier 16 Silicon Transistors

Power Amplifier 18 Silicon Transistors
12 Diodes

FM TUNER

8 Tubes, 4 Transistors, 10 Diodes

Power Supply 8 Rectifiers

1 Zener Diode, 1 Transistor

POWER REQUIREMENTS: 117 volts, AC, 50/60 cycles, 70-270 watts

MECHANICAL SPECIFICATIONS:

SIZE: Front panel, 16 inches wide by 5 1/2 inches high; Chassis, 15 inches wide by 5 1/8 inches high by 14 1/2 inches deep, including connectors. Clearance in front of mounting panel including knobs, 1 1/2 inches.

WEIGHT: 34 pounds net, 47 pounds in shipping carton.

FINISH: Front Panel, Anodized gold and black.

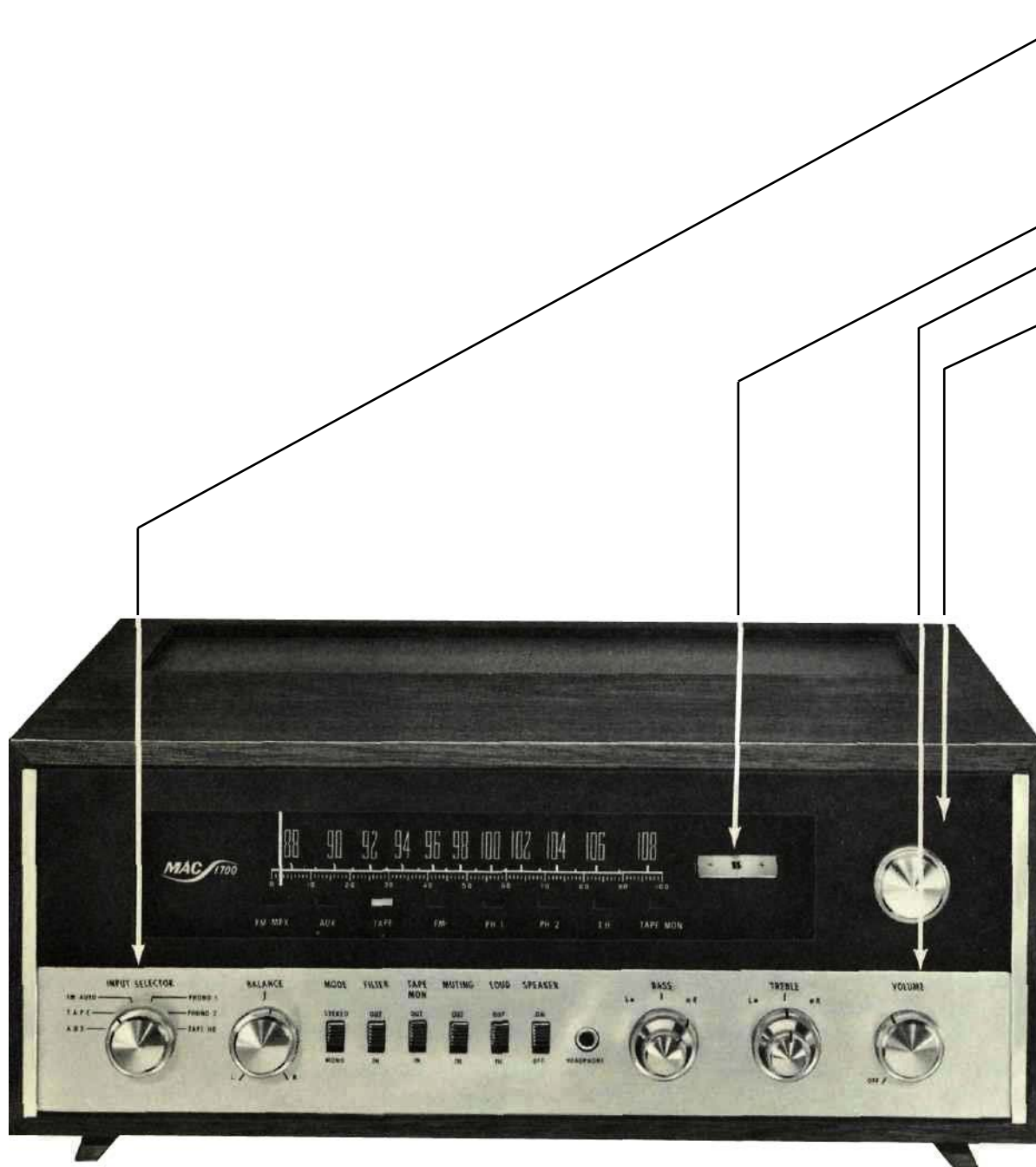

- 1 Input Selector . . . Aux . . . for any device connected to the AUX input on the back, TAPE . . . listen to playback from a tape recorder. FM AUTO . . . listen to FM Stereo or Mono broadcast automatically . . . Phono 1 and Phono 2 for phonograph records. TAPE HD . . . listen to a tape player that hasn't any electronics.
- 2 Tune for center of black area.
- 3 Adjust to desired volume. Power off. Turns the system on off.
- 4 Tuning . . . select desired station.
- 5 Treble . . . modifies high frequency sounds. Set to your taste.
- 6 Bass . . . modifies low frequency sounds. Set to your taste.
- 7 Headphone . . . to connect a set of low impedance stereo headphones.
- 8 Loud . . . use this switch to compensate for low volume listening and still hear full frequency range.
- 9 Filter In . reduces high frequency noise such as record surface noise and reduces low frequency noise such as turntable rumble.
- 10 Muting In . . . eliminates interstation noise. Muting Out . . . use to receive weak stations.
- 11 Tape Mon . . . monitor position used to monitor a recording when used with a tape recorder with separate playback and record heads. MUST BE IN OUT POSITION FOR NORMAL LISTENING.
- 12 Stereo . . . Mono . . . Set to stereo for all stereo program material. Mono position for all mono material.
- 13 Balance . . . to make one speaker louder than the other. Permits you to adjust for unequal sound caused by room acoustics or program material.
- 14 Will light only on stations broadcasting MPX stereo.

CABINET INSTALLATION

The MAC 1700 can be installed in furniture cabinets, or custom built installations. If the unit is to be used on a shelf or table top, mount it in the attractive MAC 15 WO cabinet.

Allow sufficient cabinet space for air circulation. Minimum internal cabinet dimensions should be $15\frac{7}{16}$ inches wide, $13\frac{5}{8}$ inches deep, and $4\frac{1}{4}$ inches high. The back of the cabinet should be left as open as possible for ventilation. Proper ventilation will insure your receiver a long trouble free life. A fan to circulate the air will further increase the life of your receiver.

The MAC 1700 installs easily from the front of the cabinet into a panel cutout. Front panels of any thickness can be used. Four screws into the bottom of the MAC 1700 through the mounting shelf hold the unit firmly in place. Due to the weight of the MAC 1700 we recommend the unit rest on a wooden shelf of at least $\frac{1}{2}$ " thickness. Unless the MAC 1700 is adequately held in place vertical mounting should not be attempted. If vertical mounting is used a fan delivering 50 cubic feet per minute must be used.

Since the MAC 1700 must rest on a shelf, locate the cutout from the back of the panel. A template to help you make mounting easy is in the packet that contains the owners manual.



The logo for the MAC 1700 receiver. It features the word 'MAC' in a bold, blue, sans-serif font, followed by a large, stylized blue wave that curves under the number '1700'. The '1700' is also in a bold, blue, sans-serif font.

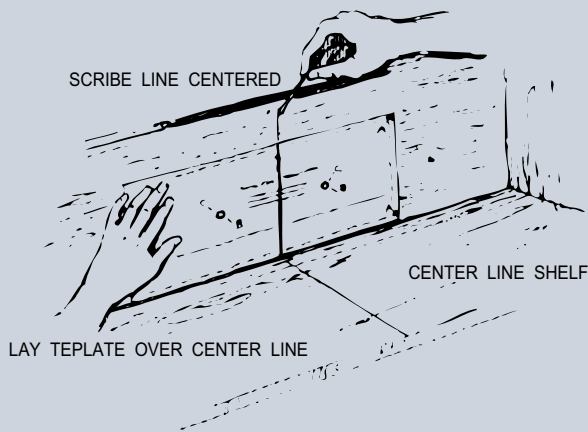

- 1 On the back of the cabinet panel, scribe a vertical line through the exact center of the area to be cut out.
- 2 Place the template against the back of the panel. Match the template centerline with the scribed centerline. The bottom of the template must rest on the shelf.
- 3 On each side of the centerline of the template there are two holes marked "B." These are the "LOCATING HOLES." These holes are used to locate the front panel of the MAC 1700 with reference to the shelf behind the cabinet panel. To insure the MAC 1700 will rest on the cabinet shelf, follow these instructions carefully.

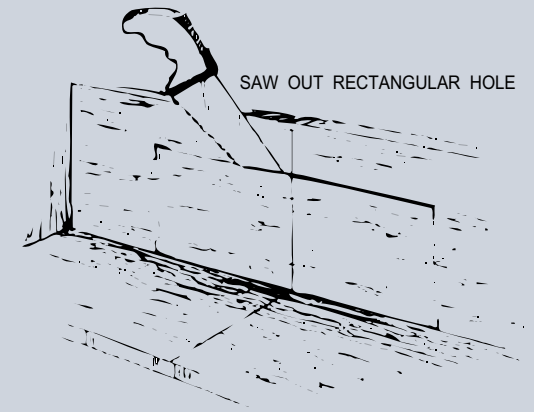

- 4 Mark the back of the cabinet panel with a pointed instrument through the two "B" LOCATING HOLES. Drill these two holes through the cabinet panel with a $\frac{3}{16}$ " diameter drill. Be certain the drill is perpendicular to the panel.
- 5 Position the template on the front of the panel. Align the "C" holes in the template with the drilled holes in the cabinet panel.
- 6 Mark the "A" corner cutouts in the template. Join the corner markers. The edge of the template can be used as a straight edge.

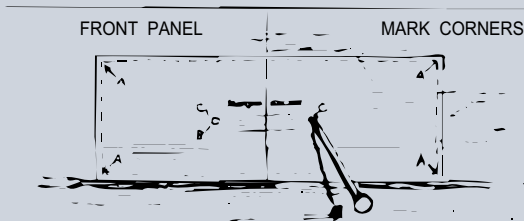

- 7 Cut out the rectangular opening.
- 8 Take the shelf template and fold along the dotted line. Put the dotted line against the back of the front mounting panel. Align the center line of the shelf template with the scribed front panel centerline.
- 9 Mark holes "A" and "B." Drill the holes using a $\frac{1}{4}$ " to $\frac{1}{2}$ " bit. The larger you make the holes the more latitude you will have to position the MAC 1700.

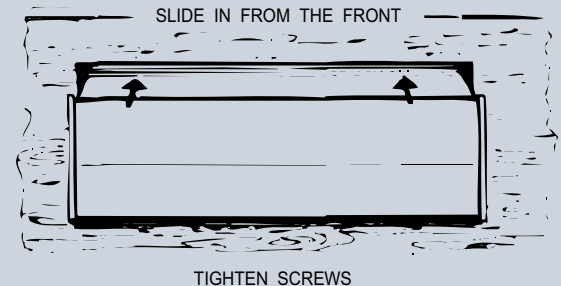

- 10 Scribe the suggested cutout outline. Cut out the area.
- 11 Prepare the MAC 1700 for mounting by removing the four plastic feet fastened under the chassis.
- 12 The MAC 1700 is installed from the FRONT of the cabinet. Insert the MAC 1700 power cord through the rectangular opening of the cabinet panel. Carefully slide the MAC 1700 through the opening. Continue to slide the MAC 1700 until its front panel is against the cabinet mounting panel.
- 13 Secure the MAC 1700 to the mounting shelf using the screws supplied in the hardware package.
- 14 Connect the MAC 1700 to the rest of the system.



INSTALLATION

CONNECTIONS TO YOUR MAC 1700

CONNECTING THE PHONO 1 POSITION for your main record player

Connect the "left" channel to the "L" input of PH 1. Connect the "right" channel to the "R" input of PH 1. If your record player has a ground wire connect the ground wire to GND.

CONNECTING THE PHONO 2 POSITION

Phono 2 position can be used if two record players are used in a system. Connect the "left" channel to the "L" input of PH 2. Connect the "right" channel to the "R" input of PH 2.

CONNECTING TAPE PLAYER (no preamplifier in tape player)

Use this position only for a tape deck with no electronics. Connect the "left" channel to the "L" input of TAPE HD. Connect the "right" channel to the "R" input of TAPE HD.

CONNECTING A TAPE RECORDER or TAPE PLAYER with BUILT-IN ELECTRONICS

Connect the "left" channel of the tape player or tape recorder to the "L" channel TAPE MONITOR input. Connect the "right" channel of the tape player or tape recorder to the "R" channel TAPE MONITOR input.

CONNECTING A TAPE RECORDER WITH THREE HEADS

Connect the tape outputs of the MAC 1700 to the high level inputs on the tape recorder. This will make it possible for you to record from the MAC 1700. Connect the tape recorder outputs to the TAPE MON inputs on the MAC 1700. Use TAPE MON . . . In for listening to pre-recorded tapes as well as to monitor.

CONNECTING A TAPE RECORDER TO RECORD FROM THE MAC 1700

Connect the TAPE OUTPUTS of the MAC 1700 to the high level inputs on the tape recorder.

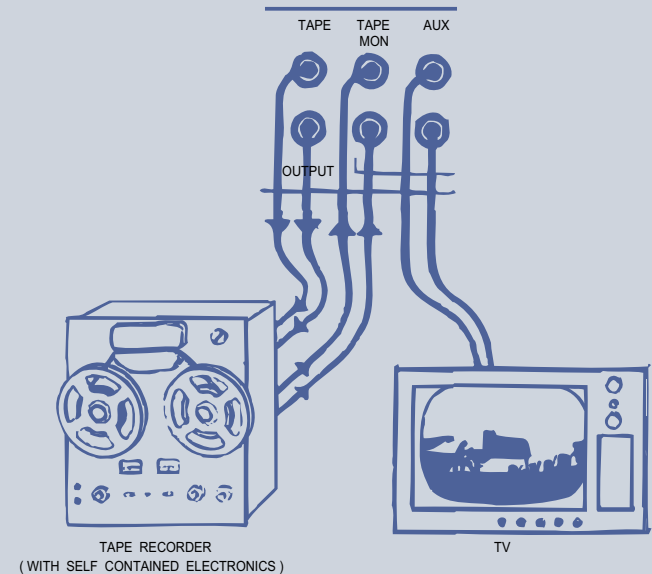
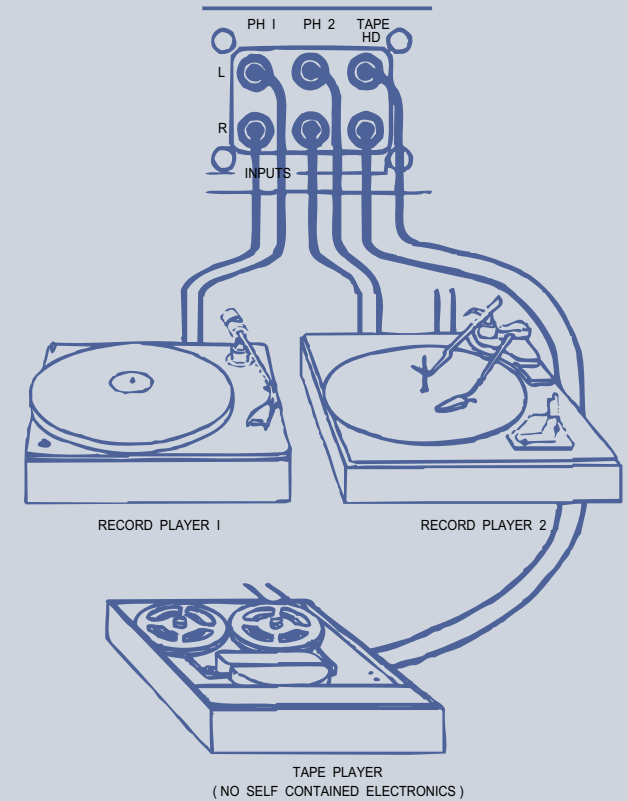

CONNECTING LOUDSPEAKERS TO THE MAC 1700

The "Left" loudspeaker wires are connected to the two center screws on the barrier strip marked "LEFT OUTPUT". The "Right" loudspeaker wires are connected to the two center screws on the barrier strip marked "RIGHT OUTPUT". The MAC 1700 automatically matches the impedance.

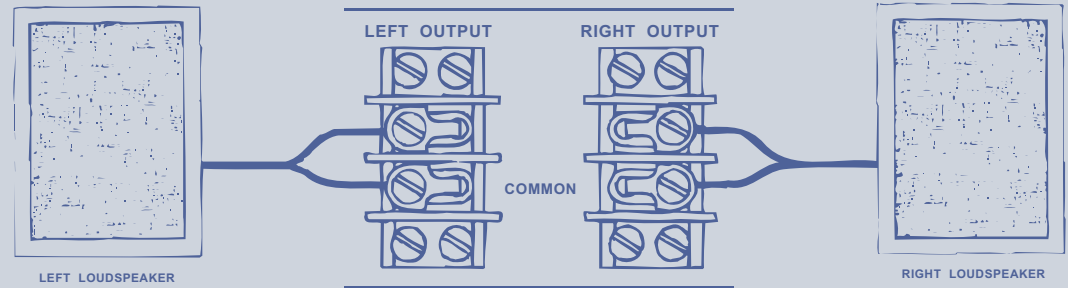

ANTENNA CONNECTIONS

A convenient flexible indoor FM dipole (300 ohm) antenna is supplied with the MAC 1700. This antenna is easy to install. It is suitable for good FM reception in high signal areas.

Connect the two leads of the dipole antenna to the two terminals marked "300" on the back panel of the MAC 1700.

The flexibility of the thick flat wire lets you easily locate the dipole behind the equipment. Open the dipole into a "T." Extend the arms as straight as possible. The dipole antenna is somewhat directional. It should be positioned for best reception of the desired stations.

OUTDOOR FM ANTENNA

An outdoor FM antenna is recommended. It will give you the best reception under all conditions. In fringe areas, a highly directional antenna used with a rotator will give the finest possible FM reception. Rotate the antenna until it points in the direction of the station or until it receives the best possible signal.

75 OHM ANTENNA

An unbalanced 75 ohm FM antenna can be used with the MAC 1700. Use the two terminals marked 75.

IMPORTANT

Keep the dipole away from large metal objects or surfaces. They interfere with the efficiency of the antenna.

MUTING (on the rear panel)

This control determines the strength of signal necessary for a station to be heard with the tuner in the muting position. The muting threshold is carefully adjusted to optimum at the factory using precision test instrument. Casual adjustment of the muting threshold is not recommended.

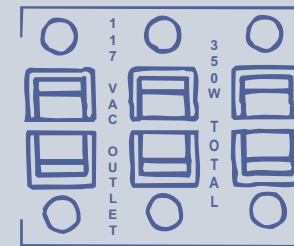
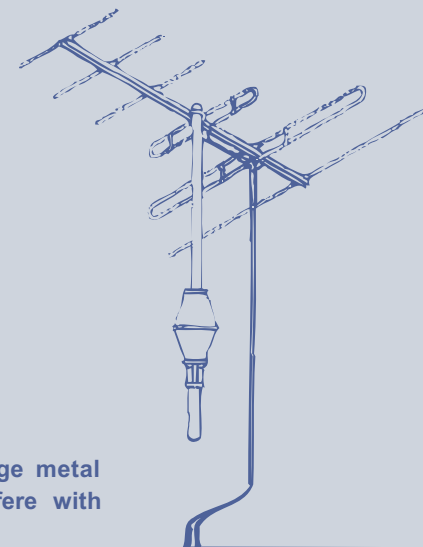

AC OUTLETS

There are two BLACK AC outlets and one RED AC outlet. The power to the black AC outlets is controlled by the front panel switch. Use these outlets for accessories such as a tape recorder. The red receptacle is on at all times and is used for a turntable or record changer. The turntable is protected by this arrangement. It is necessary to turn off the turntable or record changer by its own AC switch. Connect the AC cord from your record player to the RED outlet.

COMPLETE SYSTEM HOOK-UP TO MAC 1700

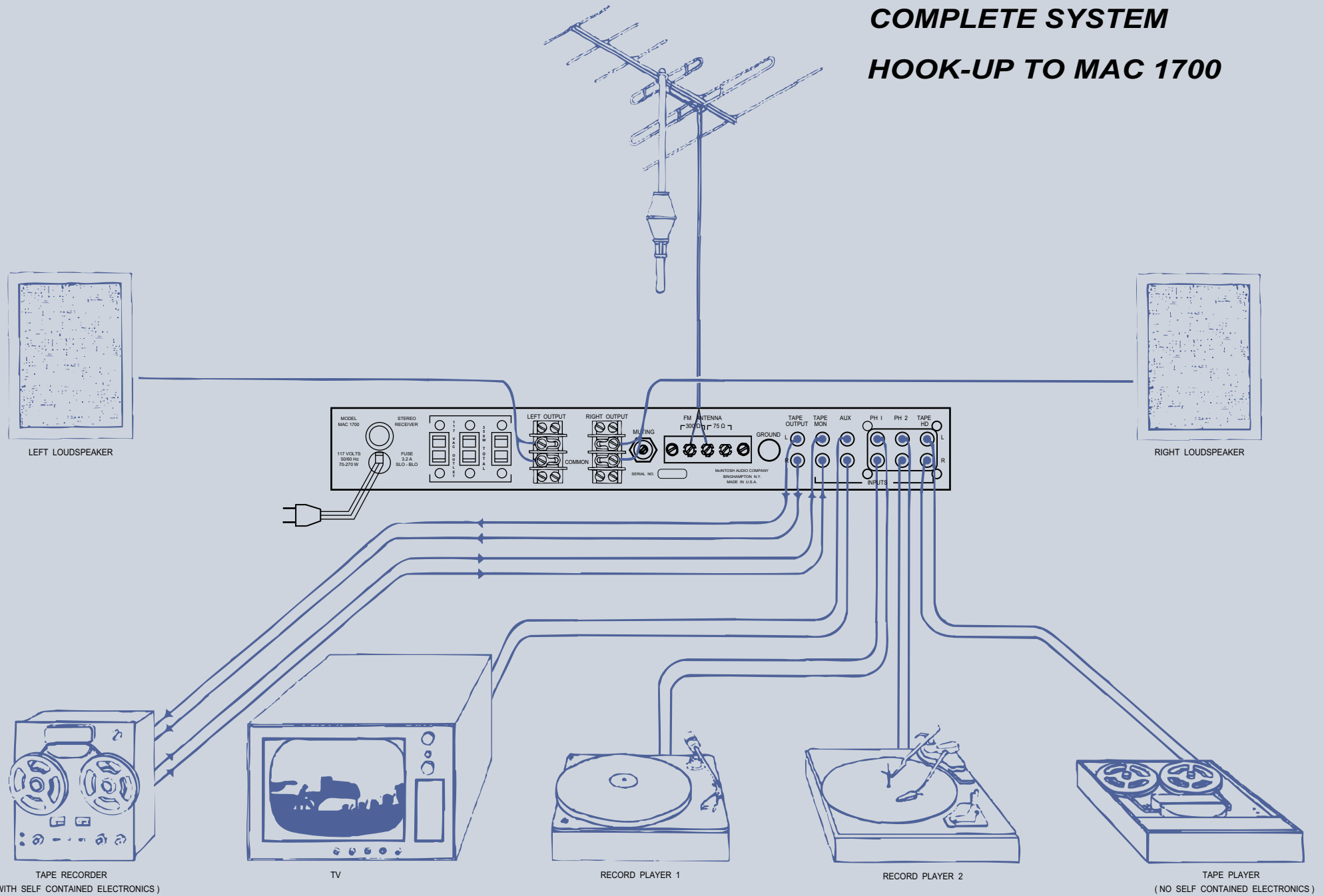

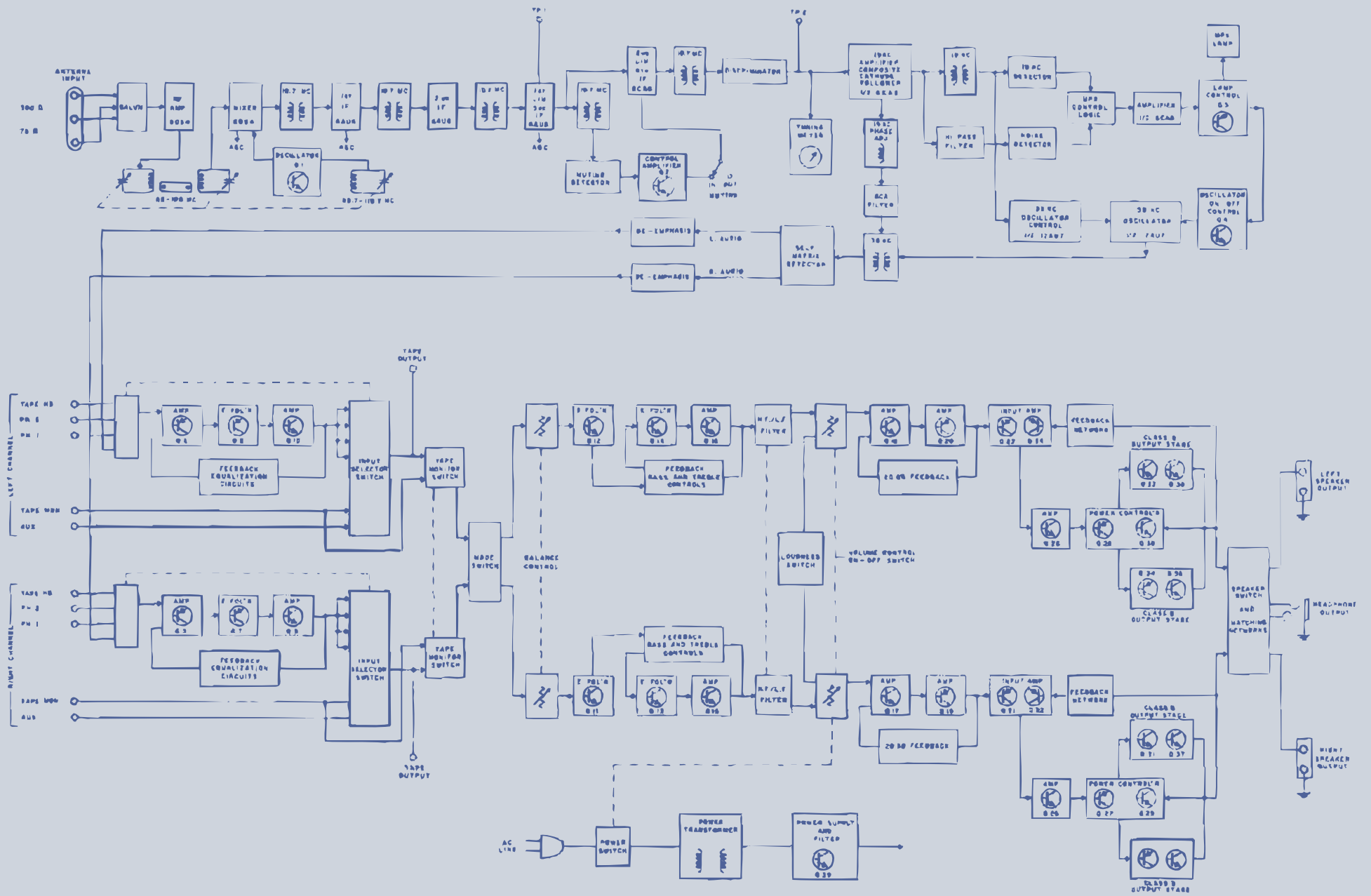

Now your enjoyment begins...

Having completed the installation of your MAC 1700 a new world of musical enjoyment is yours. The following section gives you a detailed explanation of all the controls and their functions. It will tell you how to adjust your MAC 1700 for maximum enjoyment.

If you have any further questions please write:

**Customer Service
McINTOSH AUDIO COMPANY
2 Chambers Street
Binghamton, New York 13903**



MAC *1700*

FRONT PANEL INFORMATION



TUNING DIAL SCALES—The MAC 1700 has two dial scales. The megacycle scale indicates the position of FM stations in the 88 to 108 megacycle FM band. The linear division of the 0-100 logging scale makes it easy to return to a station using a logging scale number.

INDICATORS—The MAC 1700 has two indicators on the front panel. One is the tuning meter. When an FM station is correctly tuned the indicator will be in the black area of the meter. The action of the TUNING indicator is independent of station signal strength. The second indicator is the STEREO INDICATOR. The STEREO INDICATOR will light only when the dial pointer crosses a station broadcasting multiplex stereo.

VOLUME ON-OFF—Use the VOLUME control to adjust the volume to a desired listening level. Turn the VOLUME control clockwise to increase the volume. Full counterclockwise rotation turns the unit off.

TREBLE—The TREBLE control is a dual control. The small knob controls the treble in the left channel. The large knob controls the treble in the right channel. The two knobs are friction coupled. They can be adjusted together or separately. Turn clockwise to increase treble. Turn counterclockwise to decrease treble.

BASS—The BASS control is a dual control. The small knob controls the bass in the left channel. The large knob controls the bass in the right channel. The two knobs are friction coupled. They can be adjusted together or separately. Turn clockwise to increase bass. Turn counterclockwise to decrease bass.



HEADPHONE—The headphone jack is for use with low impedance headphones. With the switch in the **SPEAKER OFF** position the loudspeakers will turn off when you insert your headphone jack. With the switch in the **SPEAKER ON** position the loudspeakers will remain in the system.

LOUD . . . An abbreviation of loudness

OUT . . . This is the normal position for moderate to loud listening levels. Use the **LOUD** . . . **IN** position to listen to low listening levels. It will allow you to hear the full frequency range. With the volume turned down there is an apparent loss of bass and treble response. When the volume is low the human ear's response to bass and treble decreases more rapidly than its response to notes in the mid-range. The **LOUD** control automatically boosts the bass and treble. With the switch **IN** the bass and treble are heard in correct proportion to the mid-range at low listening levels.

FILTER (Combination High Frequency and Low Frequency)

Use the filter switch to reduce both high frequency and low frequency noise.

OUT . . . Filter disconnect for normal flat cycles and low frequency response.

IN . . . reduce high frequencies above 5,000 cycles and low frequencies below 50 cycles.

MUTING

IN . . . turns on the muting circuit. Muting suppresses background hiss and noise usually heard when tuning between stations. Weak or distant stations that cannot override the background noise and interference are suppressed by the muting.

OUT . . . turns off the muting to allow conventional tuning. Interstation noise will be present. Use this setting to listen to weak or distant stations that have noise or interference.

TAPE MON.

The **MAC 1700** tape switch makes it possible to instantly compare recorded material with the source signal. Tape jacks on the back panel accept a signal from a tape recorder with a monitor head and preamplifier. Add light information.

OUT . . . the program source is fed through the **MAC 1700** to the loudspeakers.

IN . . . the program source is fed from the **MAC 1700** to the tape output jacks to the tape recorder. The signal is recorded

onto the tape at the record head. The signal follows a difficult path . . . the tape is played by the playback head . . . through the playback preamplifier in the tape recorder . . . out of the tape recorder into the tape monitor inputs on the **MAC 1700** . . . then through the power amplifier of the **MAC 1700** and to the loudspeakers.

CAUTION: IF THE MONITOR LIGHT IS ON SWITCH TO THE **OUT** POSITION FOR NORMAL LISTENING.

STEREO MON.

Stereo . . . for all normal stereo listening.

Mono . . . for all normal monophonic listening.

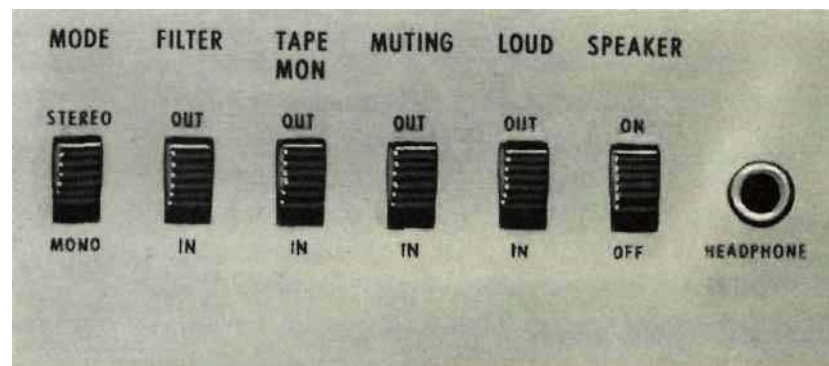

BALANCE

Use the MAC 1700 BALANCE control to balance unequal volume in the left and right channels.

Left . . . turning the control to left accents the left channel by reducing the right channel output.

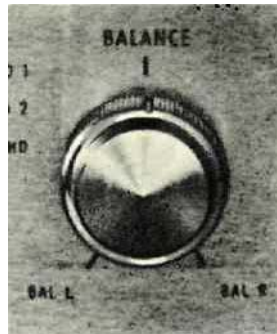

Right . . . turning the control to the right accents the right channel by reducing the left channel output.

INPUT SELECTOR

Select any one of six program sources with this switch.

FM AUTO . . . Use this position to listen to all FM broadcasts. The tuner will automatically switch to stereo on all stations broadcasting stereo. The tuner will return to mono operation when you tune in a station broadcasting mono.

TAPE: . . . Any self-contained tape recorder (one with built-in playback electronics.)

AUX . . . any auxiliary service requiring flat amplification, such as a television set, or tape recorders.

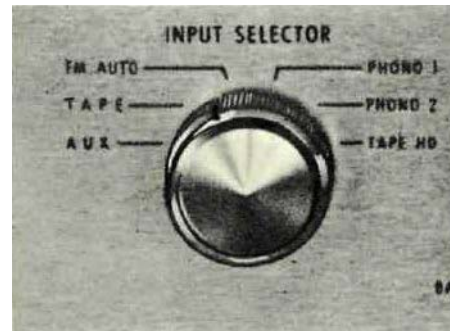

PHONO 1 ...connects the MAC 1700 for stereo and monophonic operation of records.

PHONO 2 . . . Some as PHONO 1.

TAPE HD . . . A tape deck that does not contain its own playback preamplifier is connected to the MAC 1700 through the TAPE HD position.

NOTE: OWNERS OF TAPE RECORDERS WITH SEPARATE RECORD AND PLAYBACK HEADS USE THE TAPE MONITOR POSITION TO PLAY BACK PRE-RECORDED TAPES.

SETTING YOUR CONTROLS...

Balancing a stereo system

The performance and enjoyment of your stereo system increases when the system is balanced. There are two factors in balancing. One is unequal program loudness on the left and right channels of the program source. The other is basic system balance. The control marked BALANCE on the MAC 1700 is used to correct both of these problems.

First balance the system. There are many things which affect the balance of your system: room acoustics, furniture placement, room shape, small differences in loudspeakers, etc.

TO BALANCE SYSTEM

- 1 Set the stereo mono switch to MONO.
- 2 Play a familiar recording.
- 3 Turn the balance control to the 12 o'clock position.
- 4 While the program is playing, stand in the center of the two loudspeakers. Listen to see if there is a difference in loudness from either speaker. The sound should come from a point midway between the speakers. If it does not, turn the control toward the speaker that is not as loud as the other. Do this until you find the point where the sound comes from the mid-point between the speakers. If it is impossible to get the sound to come from the mid-point go on to ADJUSTING PHASE. After you have adjusted the phase you can start the balancing procedure over again.

ADJUSTING PHASE

- 1 Set the MONO STEREO switch to MONO.
- 2 Stand about 10 feet in front of and mid way between your loudspeakers. The sound should appear to be directly in front of you. Have someone switch the leads on one speaker. Be sure to switch the leads on ONE speaker only. If the sound is not directly in front of you reverse the leads on one loudspeaker. When the sound comes from the mid-point between the speakers they are in phase.



Enjoying YOUR SYSTEM

LISTENING TO A STEREO RECORD

- 1 Turn the INPUT SELECTOR to PHONO 1 or PHONO 2, whichever is connected to the record player you wish to hear.
- 2 Set the MONO STEREO switch to STEREO.
- 3 Adjust the VOLUME control to the desired volume.

LISTENING TO MONOPHONIC RECORDS

- 1 Turn the INPUT SELECTOR TO PHONO 1, or PHONO 2, whichever is connected to the record player you wish to hear.
- 2 Turn the STEREO MONO switch to MONO.
- 3 Adjust the VOLUME control to the desired volume.

LISTENING TO TAPE DECKS

- 1 Turn the INPUT SELECTOR to TAPE HD.
- 2 Turn the STEREO MONO switch to STEREO. If a mono tape, turn the balance control to the side you want to hear.
- 3 Adjust the VOLUME control to the desired volume.

LISTENING TO A STEREO TAPE RECORDER WITH ITS OWN PLAYBACK PREAMPLIFIER

A stereo tope recorder with its own playback preamplifier should be plugged in the AUX INPUT . . . NOT THE TAPE HD. INPUT.

LISTENING TO A STEREO TAPE RECORDER

The AUX input is used-

- 1 Turn the INPUT SELECTOR TO AUX.
- 2 Switch the STEREO MONO switch to STEREO or MONO depending on the program on the tape.
- 3 Adjust the VOLUME control to the desired volume.

USING A TAPE RECORDER WITH THREE HEADS AND SEPARATE PLAYBACK PREAMPLIFIER

To listen to tapes connect your tape recorder to the TAPE MON inputs on the rear of the MAC 1700.

- 1 Switch TAPE MON to "IN."
- 7 Switch the STEREO MONO switch to STEREO MONO depending on the program on the tape.
- 3 Adjust the VOLUME control to the desired volume.

MONITORING WHILE RECORDING

To monitor while recording your tape recorder must have separate record and playback heads as well as separate playback preamplifiers. The TAPE MONO switch lets you monitor the quality of tape recording made from the MAC 1700 during the process of recording. When the TAPE MONO switch is in the IN position it will play the sound from the tape as it passes the playback head, a moment after it is recorded. The recording process continues as usual. When the switch is in the OUT position normal program from the source is heard.

Your MAC 1700 stereo receiver will give you many years of pleasant and satisfactory performance. If you have any questions concerning the operation or maintenance of this receiver please contact:

CUSTOMER SERVICE

McIntosh Audio Company
2 Chambers Street
Binghamton, New York 13903
Our telephone number is 723-3512
The area code is 607

GUARANTEE

McIntosh Audio Company guarantees this equipment to perform as advertised. We also guarantee the mechanical and electrical workmanship and components of this equipment to be free of defects for a period of 90 days from date of purchase. This guarantee does not extend to components damaged by improper use nor does it extend to damage incurred during transportation to and from McIntosh Audio Company.

TWO YEAR FACTORY SERVICE CONTRACT

An application for a Free Two Year Factory Service Contract is included in the packet with this manual. The Free Two Year Factory Service Contract will be issued by McIntosh Audio Company upon receipt of this completely filled out registration form. The terms of this contract are defined in the Two Year Factory Service Contract. If this application is not mailed to McIntosh Audio Company, only the service offered under the standard 90 day guarantee will apply to this equipment.

*TAKE ADVANTAGE OF 2 YEARS OF FREE FACTORY
SERVICE BY FILLING IN THE APPLICATION NOW*



MAC 1700

Precision craftsmanship and painstaking attention to finest accuracies make the MAC 1700 meet high standards.

McIntosh

AUDIO COMPANY

2 Chambers St., Binghamton, N.Y.

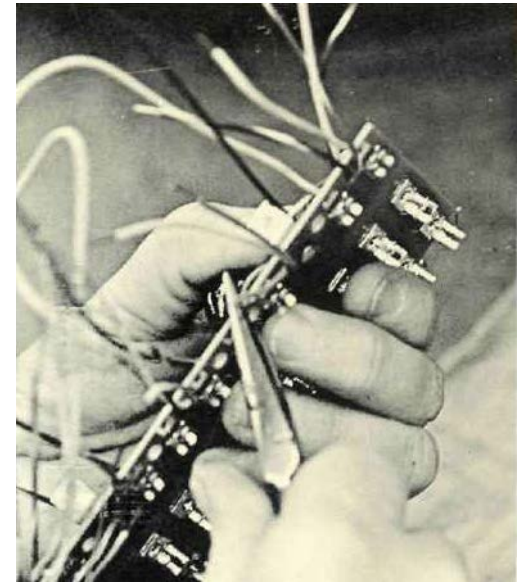

MADE IN U.S.A.

Phone-Area Code 607-723-3512

Design subject to change without notice.