



LUXMAN

SQ700X

SOLID STATE STEREO INTEGRATED AMP. OPERATION MANUAL

NOMENCLATURE AND USAGE OF EACH CONTROL

1) Input Selector Switch

This switch permits proper selection of desired programme sources. You may set either of the positions (PHONO-1, PHONO-2, AUX-1, AUX-2). Input selection shall be completed by setting this switch on the corresponding position to the desired programme sources after connection of input.

2) Treble Level Control

This is level control to vary the treble response. A clockwise turn of the knob boosts the treble response, and counter-clockwise decreases and cuts off. This knob has the click-stopper of 11 points, and yields flat frequency response at the centre of rotation angle. You can choose a turn-over (roll-off) frequency at either of 2.5KHz or 5KHz with the selector switch (3).

This level control is of independent structure, and permits separate control of both left and right channels. The left one is for left channel and the right one for right channel. This is convenient for adjustment of different levels between both channels due to different output of the speaker systems.

3) Treble Frequency Selector Switch

Treble turn-over or roll-off frequencies of the treble level control(2) can be selected by this switch. You may choose 2 points (2.5KHz, 5KHz). By setting on 2.5KHz position you can intensify treble response of tone control for the purpose of adjusting the treble end response by leaving the mid range on the flat response this switch shall be set on 5KHz position.

4) Bass Level Control

A clockwise turn of this knob boosts the bass response, while counter-clockwise decreases and cuts off. This control is of the same structure as that of Treble Level Control(2) and an operation corresponds to what is expressed in (2).

5) Bass Frequency Selector Switch

Function-wise this is the same with Treble Frequency Selector Switch expressed in (3). To intensify tone control effect it shall be set on 500Hz position.

6) Tone Defeat Switch

By setting this switch on "defeat" position a flat frequency response is obtained irrespective of the positions of Bass Level Control and Treble Level Control.

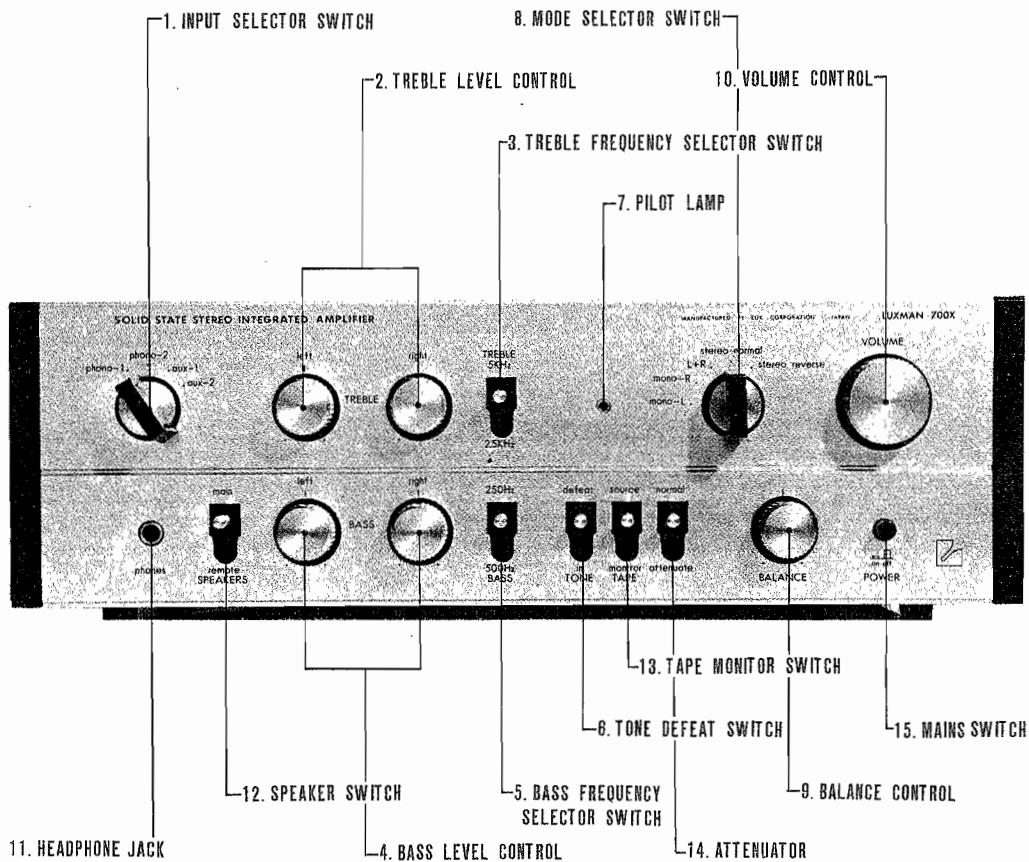

■ Control of Volume Balance

In case of deviation between the volume levels of right and left channels, adjust unbalanced volume level by the Balance Control(9). A complete turn of the knob to either of clockwise or counter-clockwise direction causes to cut off the volume of the other end speaker. The volume balance of both channels can be adjusted so that monaural disc sound reproduced by the stereo cartridge under setting the Mode Selector Switch at the "stereo" position comes from the centre of the right and left channels. Usually the volume level of both channels can be adjusted identical at the centre click-stop position of the balancer. Thus a proper balance is established through whole of playback stages from the pick-up to the ears of listener through the speaker systems. If a programme source may have deviation of the volume level between 2 channels, establish correct balance with this balancer in each case.

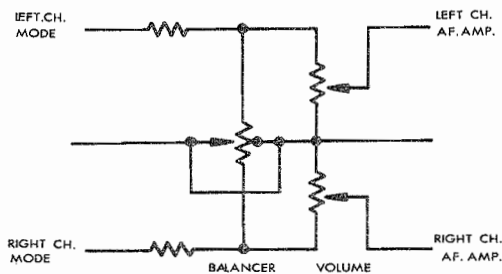

■ Tone Control

The ultimate purpose of the audio system is to make the high fidelity reproduction of programme sources. Due to difference of conditions and circumstances at reproduction from recording conditions, and the audio components it is impossible to reproduce the same sound with the original one. Also there is no objective standard to judge good sound from inferior one. The only possible solution is for every listener to create his favorite sound to match his listening room according to his own taste. It is therefore very important that the audio system offers such facility to permit flexible controls for creation of the best sound. This amplifier is equipped with the LUX original NF type turn-over roll-off frequency selector for subtle and minute control of the reproduced sound. Tone controls include Treble Level Control(2), Bass Level Control(4), Treble Frequency Selector Switch(3), Bass Frequency Selector Switch(5). First of all note that if the Tone Defeat Switch (6) is set at the "defeat" position tone controls are not in function yielding flat frequency response irrespective of positions of the tone control switches. In order to be in function of the tone controls the Tone Defeat Switch(6) shall be set at the "in" position. Treble Frequency Selector Switch(3) has 2 points, namely 2.5KHz and 5KHz and from this point Treble Level Control(2) starts to function. In other words turn-over and roll-off of higher frequency range above this point can be controlled by Treble Level Control(2). The position of 2.5KHz has wider controllable range than 5KHz. Treble Level Control(2) which functions in conjunction with Treble Frequency Selector Switch(3) is

a tone control on frequency response of high frequency range. It is designed so that response is flat at the electric centre point, and a clockwise turn of the knob intensifies high frequency range while counter-clockwise turn yields attenuation. For easy adjustment this control is equipped with 11 points of click stopper.

This volume controls are independent each other and therefore convenient for adjustment of volume for right and left speaker systems. Bass Selector Switch(5) has 2 points, namely, 250Hz and 500Hz, and from this point Bass Level Control(4) starts to function. Tone control for turn-over and roll-off of lower frequency range is more effective at higher frequency, that is to say, tone control at 500Hz is more effective than at 250Hz. Bass Level Control(4) which functions in conjunction with Bass Frequency Selector Switch(5) is a tone control on frequency response of low frequency range. It is designed so that response is flat at the electric centre point, and clockwise turn of the knob intensifies high frequency range while counter-clockwise turn yields attenuation. This control is also equipped with 11 points of click stopper.

Tone controls of this amplifier are independent between right and left channels, and therefore for example in case of feeding music for right channel and voice for left channel the tone can be simultaneously adjusted in the best manner. For details of these tone controls' characteristics, refer to the attached chart of response curve.

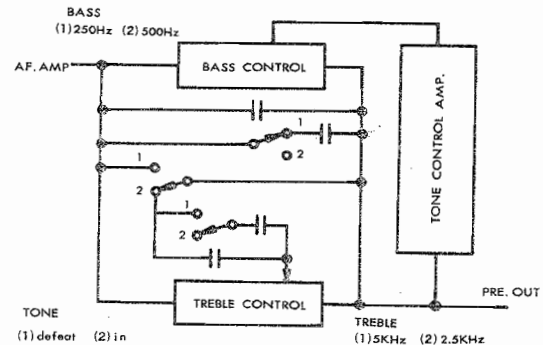

■ Operation of Attenuator

This switch is normally set at the "normal" position. If switched over to the "attenuate" position attenuator starts to function and the gain will be attenuated by 18dB (about 1/8). Useful when subdued volume level is desired for volume adjustment. Also this can be used as a momentary speaker silencing switch. For reproduction in the mid-night with small volume this switch is useful for fine adjustment of volume level. A void switching over to "normal" at the high volume level, since sometimes such momentary big sound is reproduced as may destroy speakers. See to it that this switch is set to the "normal" position after using for attenuation.

ensures simultaneous recording on tape and playback of the sound recorded on the tape.

In this case recording on tape and playback of the recorded sound are practised at the same time, and connection must be made for both functions. Need to connect the Recording Output Terminals(21) to the Line Input Terminals (AUX Input) of tape-recorder, and the Tape Monitor Terminals(22) to the Output Terminals (LINE OUT) of the tape-recorder. For connection the pin-jack lead is used.

Then if the Tape Monitor Switch(13) is set at the "source" position, original sound is fed to the speakers and if at the "monitor" position, recorded one is fed to the speakers. It makes possible to compare the original sound with recorded one by changing position of the Tape Monitor Switch(13). Thus possible recording error can be prevented in case of 3-head tape-recorder. Incidentally note that reproduction of recorded sound becomes a little bit delayed as compared with that of original sound since there is a gap between recording head and playback head. Simultaneous playback monitoring can be made through the Tape Connector(23) as well. A single piece of DIN cord ensures connection for recording and playback, and simple operation of switching "source" and "monitor" of the Monitor Switch(13) is sufficient.

■ **About DIN Tape Connector**

The Tape Connector(23) of this amplifier is of DIN norm. As explained in the paragraph of "Playback from Tape" and "Recording on Tape" if the tape-recorder is provided with the DIN connector, connection for both playback and recording is completed by use of single piece of DIN cord. See to it that this connection is practised only by DIN cord since the impedance at Recording Output Terminals (DIN) is kept relatively high at $80k\Omega \pm 20k\Omega$.

OPERATION OF TONE CONTROLS

■ **Selection of Mode (Conversion of Playback Mode)**

This amplifier is for stereophonic playback and intergrates independent amplifiers for 2 channels (right and left). Without the Mode Selector the signals fed to the left channel terminal are reproduced at the left channel speaker. The Mode Selector Switch (8) is placed between these 2 amplifiers to change the mode of reproduction.

selector knob position	connection input output	performance	use
STEREO NORMAL	L → L R → R	left input to left output and right input to right output	for normal stereo playback
STEREO REVERSE	L → R R → L	right and left inputs are reversed at outputs	when program source is reversely connected
MONO L + R	L → L R → R	right and left inputs are integrated	for playback of monaural record with stereo phono pick-up
MONO L	L → L R → L	left input signal is reproduced from both right and left speakers	for monaural program source playback
MONO R	L → R R → R	right input signal is reproduced from both right and left speakers	

PLAYBACK OF AM/FM BROADCASTING PROGRAMME

Connection of the output terminals of AM/FM tuner to the AUX terminal of this amplifier ensures playback of AM/FM broadcasting programme. This amplifier is provided with 2 AUX terminals (18) (19) and you may connect whichever you like. The Input Selector Switch(1) must be set at the corresponding position.

As shown in the block diagramme the input signals from tuner are fed to the Tape Monitor Switch after selection at the Input Selector Switch. Afterwards the signals trace the same blocks as explained in the paragraph of "Playback from Record Disc", and are reproduced from the speaker systems. Both for FM stereophonic and monaural broadcasting the Mode Selector Switch(8) of this amplifier can be set at the "stereo" position, for such accommodation to the input source can be made in the tuner.

In case of AM programme there is possible trouble of modulation hum, which can be eliminated by varying the distance and angle of these components.

OTHER PLAYBACK

The signals of flat frequency response from such sources as TV receivers do not need an equalizer stage, and for playback of such audio equipments any of these AUX terminals can be used. Connection and operation is the same with that of AM/FM broadcasting programme.

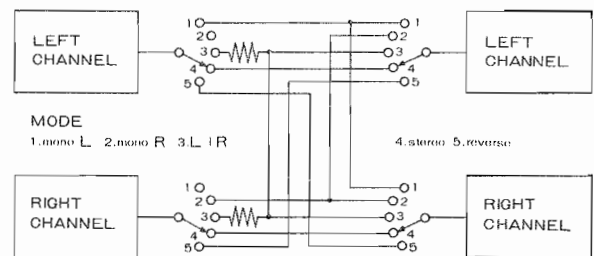

■ **Control of Volume**

Sound volume can be properly adjusted by the Volume Control(10). The variable resistor yields A type curve. In the attenuation characteristics of A type turning angle is proportionate to attenuation degree of dB, and the dB value and the volume audible to human ears are in the proportionate relation. That is to say, the rotation of knob is in proportion to the sound volume felt by human ears. The increasing degree of volume is felt quite natural as the knob is turned on to the clockwise direction.

Switch(13), Speaker Switch(12) and Volume Control(10). Now all preparations have been completed. Check if playback sound comes from both right and left speaker systems, or if volume levels are identical. If playback sound comes only from one channel, check connection of input terminals, speaker systems or position of balance control.

■ Pick-ups

There are various types of cartridges-magnetic type, photo electric type, electrostatic type and piezo-electric type. Most predominant is magnetic type wherein included are MM (Moving Magnet), IM (Induced Magnet), MI (Moving Iron) and MC (Moving Coil), and the PHONO terminal of this amplifier is designed to match with the cartridges of these specified types. But the pick-up of low output level (output voltage 0.01 - 0.1mV) cannot be directly connected to this amplifier. As to this refer to the paragraph of Step-up Transformer for MC type. In case of photo-electric or electrostatic type, choose appropriate input terminals according to the explanation sheet of the cartridge. Among piezo-electric types there are crystal type and ceramic type, which can be generally connected to the

AUX terminals. But an equalizer characteristic is not correct (further equalization is needed), and it is scarcely used together with high class apparatus.

Step-up Transformer Unit for MC Type Phonograph Cartridges

This amplifier does not provide exclusive use connectors for a step-up transformer. However if input voltage step-up is desired, use of LUX model 6521S pin-plug type step-up transformer unit can be best recommended, which is of extremely compact size and ensures highly efficient features. Fitting of this transformer to the amplifier is simple -- insertion to the PHONO terminals. By use of this transformer low output level phonograph signals from an MC (moving coil) type can be boosted by 30 times. The core is made of superpermalloy materials to ensure superb frequency response. By-section wind-

ing coil construction and complete shielding provision for the core perfectly eliminate induced noise from external source.

Specifications 6521S (2 pcs. as a pair)

Primary end impedance	less than 4Ω
Secondary end impedance	more than 30kΩ
Step-up ratio	1:33
Frequency response	40-30,000Hz
Output voltage distortion	500mV, 0.02%
Induced noise level	less than -80dB/m
Weight	12 grammes



PLAYBACK FROM TAPE

■ Playback from Tape Monitor Terminals

Almost all tape-recorder, and tape-decks currently marketed integrate audio amplifier in the circuit. Also there is a tape-player exclusively for playback. Connect the output terminal (LINE OUT) to the Tape Monitor Terminal(22) by the pin-jack lead (shield wire). Set the Monitor Switch(13) at the "monitor" position, then the playback from tape is realized. In this case this amplifier is divided into 2 sections -- one before the Recording Output Terminal (REC. OUT) and the other after the Tape Monitor Switch, and 3-head tape-recorder makes it feasible to make recording with the former section and simultaneously to make playback with the latter section.

Note that normal function cannot be expected if 2 sets of tape-recorder for playback are connected to the Tape Monitor Terminal(22) and the Tape Connector(23) at the same time, since these 2 are coupled in the inside circuit and effect on each other.

■ Playback from AUX Terminals

Playback of tape is possible if the line output of tape recorder or tape-deck is connected to the AUX terminals of this amplifier by use of pin-jack lead and the Input Selector Switch is set at the corresponding position to the AUX Terminals. All operation in this case are same with those for the Playback of Tuner. Note that when tape playback is made through AUX terminals the line input or AUX input terminals should be kept free. If connected to the Recording Output Terminals (REC.OUT) of the amplifier there will be possible oscillation by feed-back of signals.

If volume levels on both right and left speakers are deviated, adjust it by the balance control(9). For stereophonic playback see to it that the mode selector switch(8) is kept at the "stereo" position, otherwise stereophonic playback is not feasible.

■ Playback from Tape Connector

This connector is of DIN norm, and very convenient for simple connection by a single cord between the tape-recorder and recording/playback connectors of this amplifier. A DIN cord should be connected between DIN connector of the tape-recorder and Tape Connector(23) of this amplifier. Playback from Tape Connector is possible if the Monitor Switch(13) is set at the "monitor" position.

RECORDING ON TAPE

In case of playback of various programme sources through input terminals of this amplifier, the same signals to these reproduced in speakers are always available at the Recording Output Terminals(21) and Tape Connector(23). By connection of these terminals to the input terminals (AUX or LINE-IN) of the tape-recorder you can enjoy simultaneous recording and playback. These recording signals are taken out before the Tape Monitor Switch and there is no influence of such controls as Volume Controls and Tone Controls explained in the paragraph of "Operation of Tone Controls". If there are 2 tape-recorders reprinting of tape is feasible: Connect the tape-recorder of better recording performance to the Recording Output Terminals and other one to the AUX terminals exclusively for playback setting the Input Selector Switch to the relevant position.

SIMULTANEOUS PLAYBACK MONITORING

3-head tape-recorder ensures simultaneous playback monitoring enabling to ascertain perfect recording. In case of 3-head tape-recorder, heads and amplifiers for recording and playback exist independently in the circuit, which

PLAYBACK FROM RECORD DISC

■ Connections

Generally a record player consists of a turn-table ensuring constant rotation of the record disc, a pick-up (cartridge) whose stylus (needle) traces the sound groove of the disc converting the physical signal of the recorded sound into the electric signal, and the arm which holds this cartridge. The player has 2 cords with pin plug at its end for both right and left channels. Connect the pin connectors to the input terminals of this amplifier. [PHONO-1(16) or PHONO-2(17)]. A probable earth lead of player may be connected to the GND terminal(20) of this amplifier. A mains cord of the player to drive its motor may be connected to the convenient extra mains outlet(28) of this amplifier.

This amplifier is provided with 2 input terminals (PHONO-1 and PHONO-2) to be selected by the input selector switch(1), which is useful for comparison test of 2 pick-ups or using 2 record players. For use of 1 player either of 2 input terminals can be selected.

5 Signal Paths

Put the disc on the turn-table, switch on the phono motor, and set the stylus on the groove of disc. Then recorded

signals begin to be fed to the amplifier. First the signals fed to the amplifier through PHONO terminals are brought to the equalizer section, where recorded signals are equalized and restored to the original frequency curve. Incidentally this equalizer curve has been standardized in the RIAA curve. The equalized signals are then fed to the input selector switch (function switch). If this switch is not set at the correct position of PHONO, the signals are blocked here and no more advance is possible.

After passing above first stage the signals are divided into 2 channels, which are kept at sufficiently low impedance (about 130Ω which prevents possible attenuation in high frequency caused by lengthy cable or floating capacitance). One line to the REC. OUT terminal, and the other to the tape monitor switch. If the monitor switch(13) is set at the "source" position, the signals are sent to the mode selector switch, attenuator, balance control, volume control, but if at the "monitor" position the tape monitor terminals start to function and the signals are stopped at this point. Except when the tape playback is made by tape monitor terminals, the monitor switch(13) must be kept at the "source" position. But when the input signals are fed to PHONO or AUX terminals recording output is always obtainable regardless of the position of the monitor switch.

Then the signals are sent to the volume control through the mode selector and balance control. If the volume knob is turned to the extreme end of counter-clockwise direction, the signals cannot proceed ahead. It is necessary to set this control at the optimum volume. Such controls as attenuator and tone controls are for flexible and diversified adjustment of playback sound and do not block the signals completely. This section is for adjustment of tone controls according to personal taste. The properly adjusted signals after passing tone control circuit are sent to the PRE. OUT terminals(24). If the short pin connector is set to keep connection between pre- and main-amplifier section, the signals passed through the "MAIN IN" terminals(25) reach the speaker switches amplified by the main amplifier. Sound playback from speaker systems is thus realized if the speaker switch corresponding to the speaker terminals to which the speakers are connected is switched on.

The above is the feeding path of PHONO signals starting from input terminals to the speaker systems. Difficult as it may sound you can easily understand it from the attached block diagramme. For your pleasant command of this amplifier it is recommendable to bear the block diagramme in your mind.

■ Playback Performance

Now put a disc on the turn table for playback performance. As the volume control is turned clockwise from the cut position, playback sound comes out from speakers. As explained in the paragraph of Signal Paths the sound playback is possible regardless of the position of Mode Selector, etc. as far as these essential controls are set at the correct position such as Input Selector Switch(1), Monitor

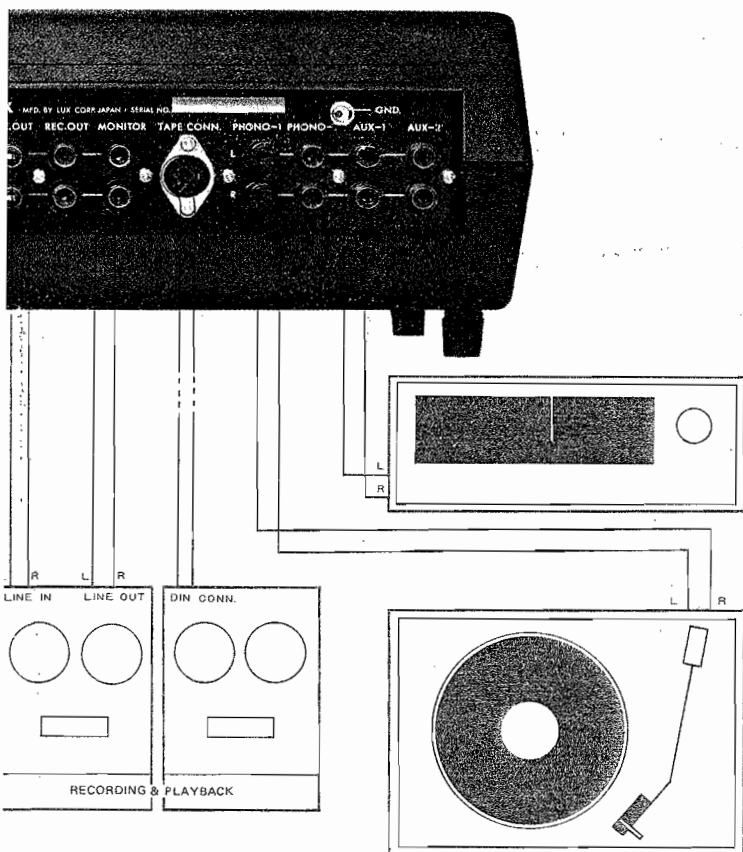

HOW TO CONNECT

■ Basic Connection

This amplifier is so-called pre-main amplifier composed by pre-amplifier section which controls playback equipments and power amplifier section which amplifies the signal to the extent that it drives the speaker systems. It functions as the stereophonic reproduction system when player, tuner, etc. are connected to the input terminals and speakers or headphone to the output terminals. Thus it is basically necessary to connect this amplifier with the input sources, outputs loads and naturally mains current.

■ Connection to Input Terminals

Connect at the relevant input terminals of this amplifier the output of player, tuner, or tape-recorder. As to the details see the chapters of Playback of Disc, Tuner and Tape-Recorder.

■ Connection Cable (Cord Wire)

For connection of these record-player, tuner and tape-recorder shield wire is used for protection from external noise or inductance noise. Usually this shield wire has the capacitance of approx. 300pF/M, that is to say, an adoption of connection cable gives the same effect to that of the insertion of capacitor in parallel with input sources or output load equipments, which composes a kind of high-cut filter circuit. For instance 2 meters of this shield wire has 600pF capacitance, and if this cord is used at the point where parallel composite value of input and output impedance is $50K\Omega$, it means an insertion of a high cut filter with the cut-off frequency at about 10KHz, which causes to yield an unnecessary attenuation of high frequency range. Use of shortest wire is, therefore, recommended especially on the equipments of high impedance.

Choose a shield wire of good quality and use it as short as possible for connection of this amplifier at the PHONO, AUX, tape-monitor, tape connector etc. with the apparatus of high impedance. In case either of input or output is sufficiently low it does not effect much, since parallel composite impedance becomes lower and cut-off frequency will be shifted out of an audible range. It does not matter if relatively long cable is used for pre-amplifier section output and recording output (REC. OUT) terminals, since their impedance is so designed as to be sufficiently low (approx. 100Ω).

■ Connection of Speakers

Stereophonic playback is made with a pair of speaker systems for right channel and left channel. This amplifier is provided with 2 channels' terminals for main speakers and remote speakers. Connection can be made in the same manner. Right hand speaker system (viewed from the listener's position) should be connected to the right speaker terminals, while left speaker system to the left terminals. Note that perfect sound reproduction cannot be expected if the phase is not matched between both channels. To match the phase is to connect the + terminal of the right hand speaker to + terminal (red cap) in right channel of this amplifier and the - terminal to - one (black cap), and to

do the same with left channel speaker. If mismatched for some reasons (for example misconnection of speakers) low frequency range is subdued and constant playback cannot be realized.

To connect the speaker terminals first strip off the end of shield wire by 10mm and insert it to the terminal hole pressing the terminal head, and then release it. You will find firm connection has been finished. After connection of the speaker systems, turn the speaker switch on to the corresponding speaker systems to which the terminals are connected. Comparative listening is possible between 2 pairs of (remote and main) speaker systems, if it is connected for both channels.

■ Connection of Mains Power Supply Source

As the final step of preparation connect the amplifier to the mains power supply source. Attached mains cord should be connected to the mains power supply source. Then press the mains switch and the pilot lamp starts to light up and the amplifier will be on function in about 2 - 3 seconds.

The mains power for other audio equipment used in combination with this amplifier can be obtained from the extra mains outlet of the amplifier.

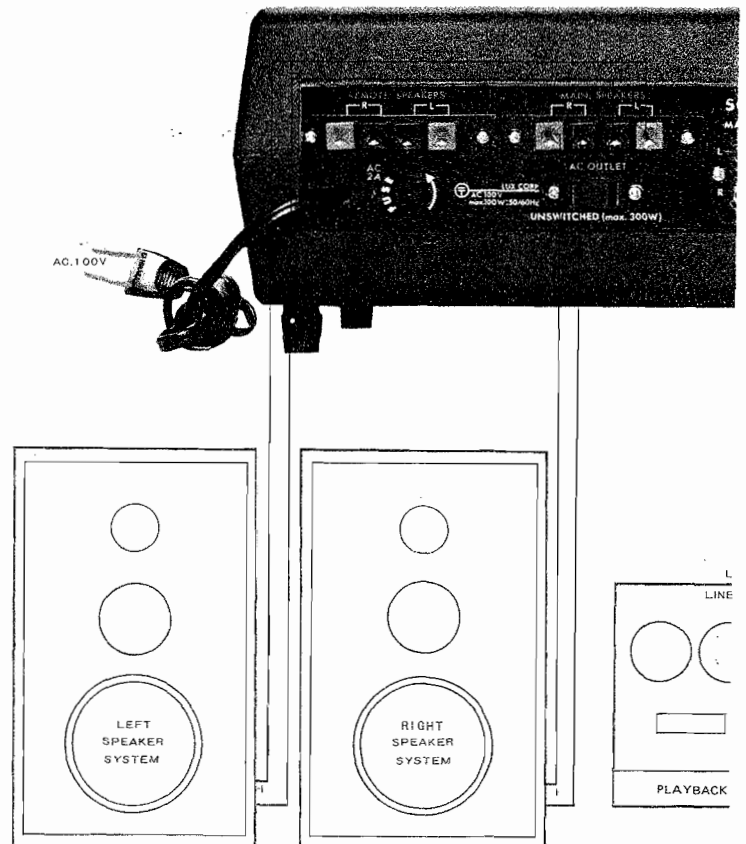

BLOCK DIAGRAM & LEVEL DIAGRAM

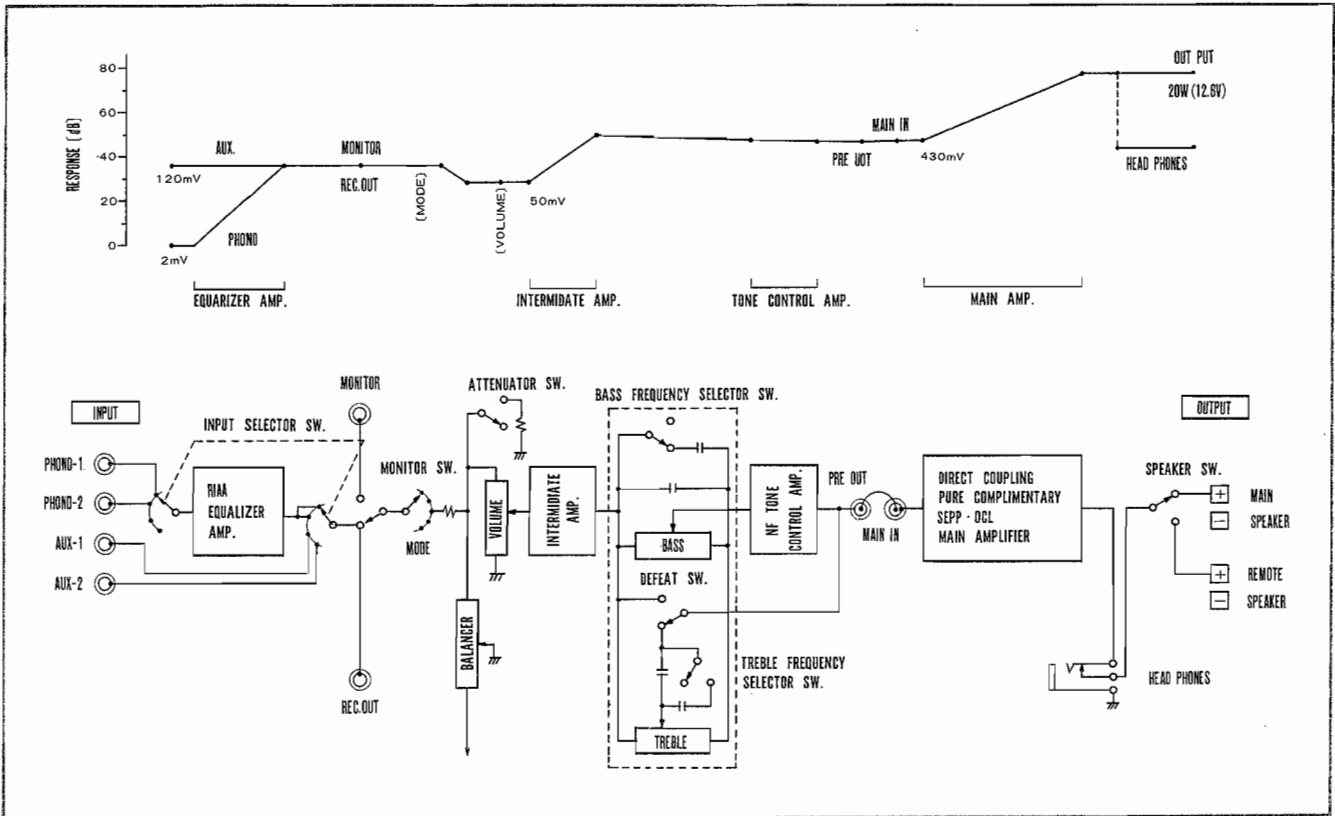

FOR CORRECT PLAYBACK

■ Inputs (Connection of Input Equipments)

Check firm connection to the amplifier's input terminals of record players, tape-recorders and AM/FM tuners etc. If no playback sound comes from speaker systems, the amplifier is apt to be, first of all, wondered as defective, but be sure about firm connection between arm — and cartridge and also firm fixation of cartridge to the shell.

■ Outputs (Connection of Speaker Systems)

Check firm connection between amplifier and speakers. The right hand speaker viewed from the listener's position must be connected to the RIGHT terminals of the amplifier, while the left speaker to the LEFT terminals. Be careful about the matching phase of left and right speakers. If mismatched, playback sound does not come from the centre of both speakers even if the mode selector is set at the "MONO" position, and in case of stereophonic playback faithful reproduction in low frequency range cannot be expected. Be sure that the speaker switch corresponding to the speaker terminals to which the speaker is connected is turned on.

■ Mains Source (Connection to Mains Source)

Check whether the mains plug of amplifier is firmly connected to the mains power source, and whether the pilot lamp lights on when switched on. In case the pilot lamp does not light on even if the electricity is fed to the amplifier, check whether the mains fuse is blown. Affirmatively change the fuse ascertaining the real cause of blow and giving necessary treatment. Replacement of fuse must be done after the mains cord is plugged out from the mains power supply point.

■ Input Selector Switch

Check correct positioning of the switch corresponding to the input terminals (PHONO, AUX) to which input equipments are connected.

■ Tape Monitor Switch

For normal playback never fail to set this switch at the "SOURCE" position. By setting this switch at the "MONITOR" position, reproduction of tape-recorder is feasible through tape-monitor terminal or tape connector.

■ Volume Control

Full turn of this knob to the counter-clockwise direction causes to yield no sound. Turn to the clockwise direction and enjoy playback at an appropriate volume.

■ Balance Control

Adjust unbalanced volumes between right and left channels. Turn to the ultimate point causes to suppress the sound completely in the corresponding channel. Usually this knob is set at the centre of click-stop point for stereophonic reproduction.

■ Attenuator

Setting of this switch subdues the volume by 18 dB (about 1/8). In case full volume cannot be obtained with ultimate clock-wise turn of volume control, check if this switch is on operation. To release the attenuator under full volume causes to yield sudden increase of volume and sometimes destroy speakers: To release attenuator under small volume is essential.

■ Mode Selector Switch

This switch is to select the mode of reproduction. For stereophonic reproduction set at the position of "STEREO", otherwise stereophonic reproduction cannot be obtained even if input signal is stereophonic.

■ Connection of Pre-Main Amplifier

For pre-main amplifier use this amplifier as it is. For independent use of pre — and main-amplifiers remove this short pin-connect.

necting this short-pin.

25) Main-Amplifier Section Input Terminal (MAIN IN)

Main-amplifier section can be independently functioned feeding the signal through this terminal by disconnecting the short-pin-connector.

26, 27) Speaker Terminals

The speaker systems should be connected to these terminals. Press the cap of the terminal and insert the speaker cord to the terminal hole. Then release it. Firm connection is now finished. These terminals are coupled with the speaker switch, and either position of the speaker switch corresponding to the terminal to which the speaker systems are connected must be set. (26) is for main speaker and (27) for remote speaker. Red terminal is for + and black for

-. At connection please arrange the matching phase of both left and right speaker systems. For further details refer to the "Connection of Speakers".

28) Extra Mains Outlet

Convenient for supply of mains power to other equipments such as AM/FM tuner and record player. The maximum rated value is 200W. This terminal is independent from the mains switch of this amplifier.

29) Mains Fuse

In the mains power circuit of this amplifier 2A fuse is inserted.

30) Mains Connector

One end of the attached mains cord should be connected with the mains power supply point.

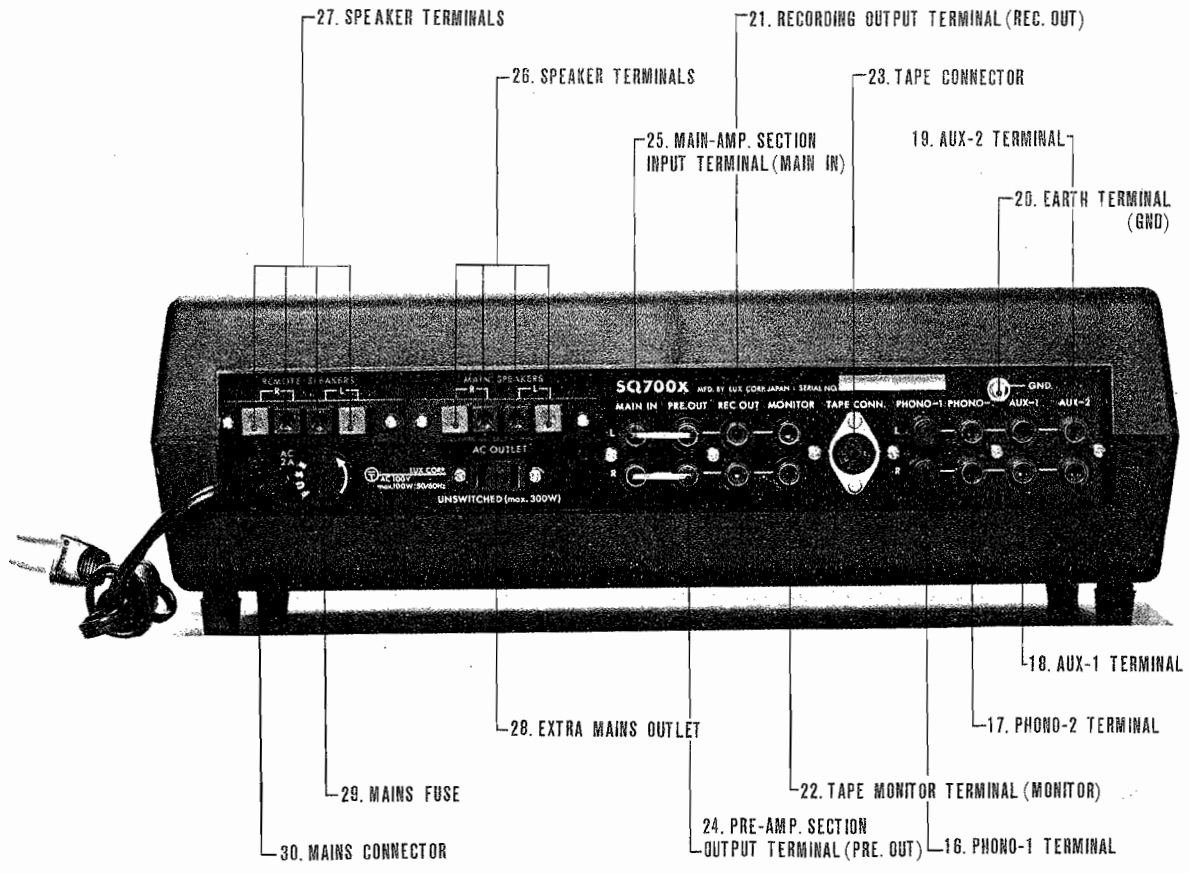

7) Pilot Lamp

Switch-on of the Mains Switch(15) causes to light this lamp, which shows the mains current is on.

8) Mode Selector Switch

With this switch you can select sound reproduction modes such as Stereophonic (Normal, Reverse) and Monaural (L.R. Mix.). For further details please refer to the "Mode Selection".

9) Balance Control

The volume balance on right and left channels can be adjusted by this control. Turn it clockwise and the volume of left channel will decrease and finally cut off, while counter-clockwise turn causes to cut off right channel. When the volume on both channels is balanced, monaural reproduction sound comes from the centre of both right and left speakers. Usually this point is obtained at the centre of balancer (click-stop point), i.e., the centre point of the knob.

10) Volume Control

This knob controls volume clockwise turn boosts volume, while counter-clockwise decreases until inaudible point.

11) Headphone Jack

Connection of stereophonic headphone to this jack allows private listening. By connection to this jack output signal to the speakers cannot be obtained.

12) Speaker Switch

Sound reproduction from 2 stereo-playback speaker systems can be controlled by this switch. Terminals for "Main" and "Remote" are available. When the lever of this switch is lifted up to "Main", main speaker terminals(26) start to function, while pressed down to the position of "Remote", remote speaker terminals start to function. In case of parallel connection of speakers total impedance shall be not less than 4Ω . Use of stereophonic headphone cuts off output signal to speaker terminals.

13) Tape Monitor Switch

When the tape monitor switch is pressed down to the position of "monitor", playback from tape-recorder is feasible either from tape monitor terminals(22) or tape connector(23). If this switch is lifted up to the ordinary position of "source", sound reproduction is possible from other sources expect tape-recorder (PHONO and AUX terminals). In case of 3-head tape-recorder which has playback head for playback in the course of recording, simultaneous playback monitoring is feasible while recording by connection of this signal to tape monitor terminals. In this case this amplifier receives the playback signals either tape monitor terminals(22) or tape connector(20), while feeding the recording signals to the recording output terminals(22) or tape connector(23).

Be attentive that if monitor switch(13) is on the position of "monitor", no playback is feasible from other input terminals (PHONO and AUX).

14) Attenuator

This is usually set in the position of "normal". Press down this switch to the position of "attenuate", and an attenuator begins to function decreasing the gain by 18dB. Useful

as a momentary volume-subduing switch of speakers.

15) Mains Switch

Repetition of pressing ensures alternately switch-on and switch-off.

16) PHONO-1 Terminal

For playback through magnetic pick-up (MM, MI, MC type). Input sensitivity 2mV. Input impedance is $50k\Omega$. Except very low output MC type pick-up (output voltage 0.01mV-0.1mV) almost all pick-ups can be used. For such MC type cartridges of extremely low output level, it is necessary to boost the voltage up to the specified level by use of step up transformers or head-amplifier.

17) PHONO-2 Terminal

Same as PHONO-1 terminal.

18) AUX-1 Terminal

This is an auxiliary input terminal for playback of flat frequency response such as AM/FM stereo-tuner, line output of tape-recorder, and audio output of television receiver. Input sensitivity 120mV and input impedance $50k\Omega$. Input level is uncontrollable.

19) AUX-2 Terminal

Same with AUX-1 terminal.

20) Earth Terminal (GND)

Connect the earth lead wire of record player (from motor or pick-up arm). This terminal may be used for earthing of this amplifier, which is, however, not always necessary.

21) Recording Output Terminal (REC. OUT)

Signal for recording is taken out from this terminal. Output impedance is designed as about 130Ω . Recording output signal is always available from this terminal.

22) Tape Monitor Terminal (MONITOR)

Line output of tape-recorder can be reproduced from this terminal. For this purpose set the monitor switch(13) at the "monitor" switch. In case of 3-head tape-recorder so-called tape-monitoring is feasible-simultaneous recording and playback.

23) Tape Connector

This connector is of DIN standard. With recording output terminal(REC.OUT) and tape monitor terminal in it, connection for recording and playback is feasible with a single lead-wire of DIN plug if the tape-recorder has the same connector. For playback through this connector the monitor switch(13) must be on the "monitor" position. Recording output signal is always available from this connector.

24) Pre-Amplifier Section Output Terminal (PRE.OUT)

Whole output in pre-amplifier section including tone controls can be taken out from this terminal. Output voltage is 430mV against the standard input. No need to worry about attenuation in high frequency range caused by use of shield wire by dint of sufficiently low output impedance of about 100Ω . This terminal is used for independent use of pre-amplifier as well as for multi-amplifier system by use of channel divider. Usually this terminal and main-amplifier input terminal(25) are connected by the specially-made short-pin connector. Be attentive to cut mains switch off beforehand when connecting or discon-

Bass Tone Control

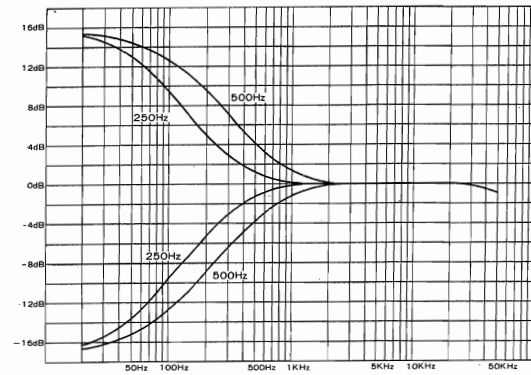

Treble Tone Control

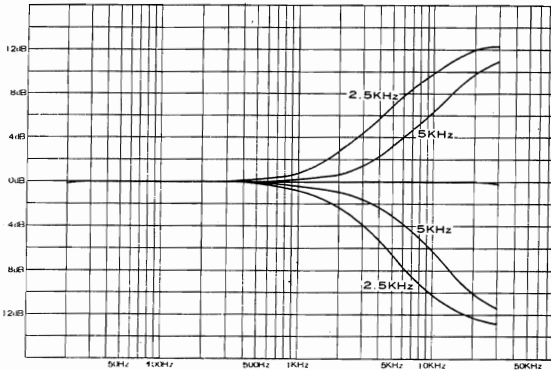

Damping Factor (8Ω load, 1W output)

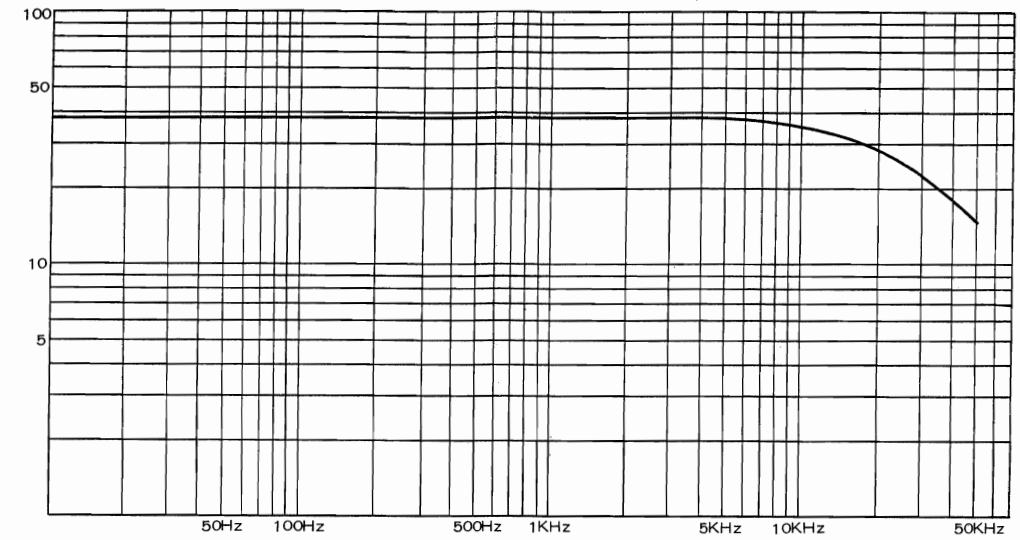

Noise + Harmonic Distortion (Input: Main In, Load 8Ω, incl. oscillator distortion 0.03%)

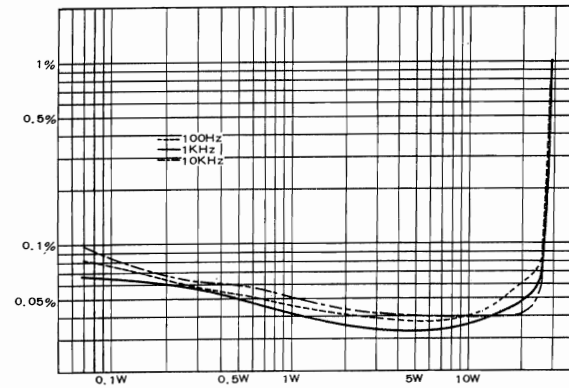

Inter-Modulation Distortion (Load 8Ω, Frequency and Modulation Ratio 70Hz; 7KHz=4)

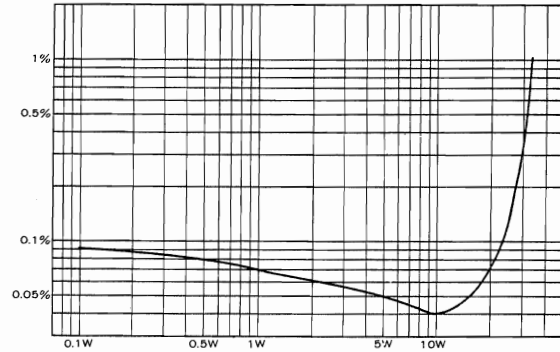

Power Bandwidth (8Ω load, 0dB 20W)

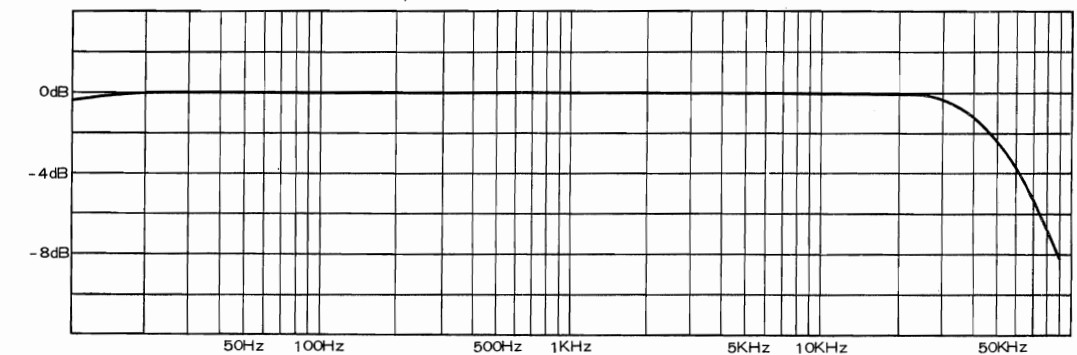

PHONO Input Voltage (Output: REC. OUT Terminal)

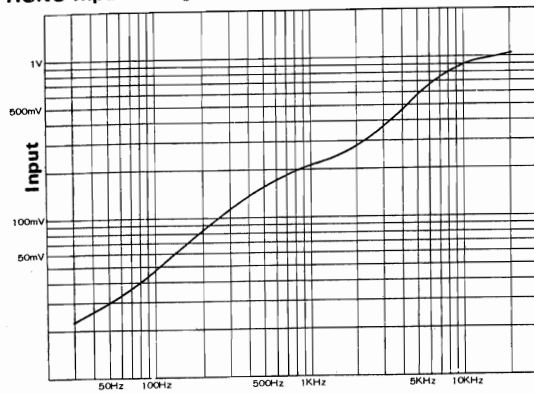

Equalizer (Output: REC. OUT Terminal)

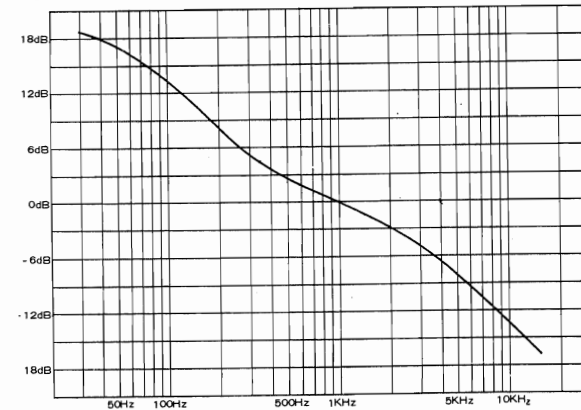

SPECIFICATIONS

MAIN AMPLIFIER
RMS OUTPUT POWER 20W/20W (8Ω both channels driven)
 25W/25W (8Ω single channel driven)
 less than 0.1% (8Ω 20W)
THD
INTERMODULATION DISTORTION
POWER BANDWIDTH 10 - 50,000Hz (-3dB, 0.1%)
INPUT SENSITIVITY 430mV (8Ω, 20W)
INPUT IMPEDANCE 40kΩ
RESIDUAL NOISE less than 0.5mV
DAMPING FACTOR 38(8Ω) 76(16Ω)

PRE AMPLIFIER
OUTPUT VOLTAGE PRE.OUT.: 430mV
OUTPUT IMPEDANCE PRE.OUT.: about 100Ω
FREQUENCY RESPONSE 10 - 50,000Hz (-1dB)
THD
INPUT SENSITIVITY less than 0.04% (1KHz, 1V)
 phono-1, phono-2 : 2mV
 aux-1, aux-2 : 120mV
 phono-1, phono-2 : 50KΩ
 aux-1, aux-2 : 50KΩ
INPUT IMPEDANCE

S/N RATIO

phono-1, phono-2 : more than 60dB
 aux-1, aux-2 : more than 70dB
 phono: 200mV (1KHz)

MAX. PERMISSIBLE INPUT VOLTAGE RESIDUAL NOISE TONE CONTROLS

less than 45μV
 Lux NF type with turn-over (roll-off)
 freq. selector. Bass: 250Hz, 500Hz
 Treble: 2.5KHz, 5KHz

TRANSISTORS AND OTHERS

TRANSISTORS 2SD155(2), 2SA616(2), 2SC495(5), 2SA505(2),
 XA495C(5), 2SA493(8), 2SC1000(4)
DIODES 5B1(1), SR1K-4(1)
VARIABLES KB265(4)
ANNEXED CONTROLS attenuator, speaker switch, tone defeat switch,
 head-phone jack, etc.
POWER CONSUMPTION 100W(8Ω, max. output, both channels driven)
DIMENSIONS 373mm(W) x 227mm(D) x 125mm(H)
WEIGHT 7.8kg

FOR YOUR ATTENTION

■ TAPE MONITOR SWITCH

When this switch is left to be positioned at "monitor" the signals put into through other input terminals come out only from the "REC.OUT" terminals and no sound playback is possible from speakers. This is often taken for defect. As far as the playback is made from other sources than tape-recorder never fail to put this switch at the "sources" position.

■ TO CONNECT LOW IMPEDANCE SPEAKERS

When more than 2 speakers are connected in parallel to one channel of the speaker terminals, please see to it that the composite impedance be more than 4Ω. If such low impedance speaker as condenser speaker is used, connect resistor of about 2Ω in series with this speaker.

■ LOCATION

Transistors are sensitive to heat, and the rear panel, the upper side of the bonnet etc. are designed in consideration of heat radiation. Therefore please do not place this amplifier near heat-radiating stuff; heat escalation inside amplifier may cause defect.

■ REAR PANEL

The rear panel of this amplifier is designed as a heat sink for the power transistors. Slight increase of temperature at the rear panel is not a defect.

■ FUSE FOR MAIN AMPLIFIER

This amplifier is equipped with the fuse(3A) at the output circuit for protection of power amplifier etc. When no playback sound comes out even if the mains switch is put on and the pilot lamp is on, this fuse is considered to be blown for some reasons. In this case please check if the fuse is blown opening the bonnet case after disconnection of the mains plug from the mains supply source. If found blown replace it with attached one (3A) ascertaining the real cause of such blow.

■ MAINS FUSE

When the fuse(2A) at the rear panel is found blown ascertain the cause of blow and repair the defective point, and replace it with the rated one. The fuse can be replaced if the fuse cap is unscrewed by the + driver to the direct of an arrow mark. Please see to it that the mains cord is disconnected with the mains supply source.

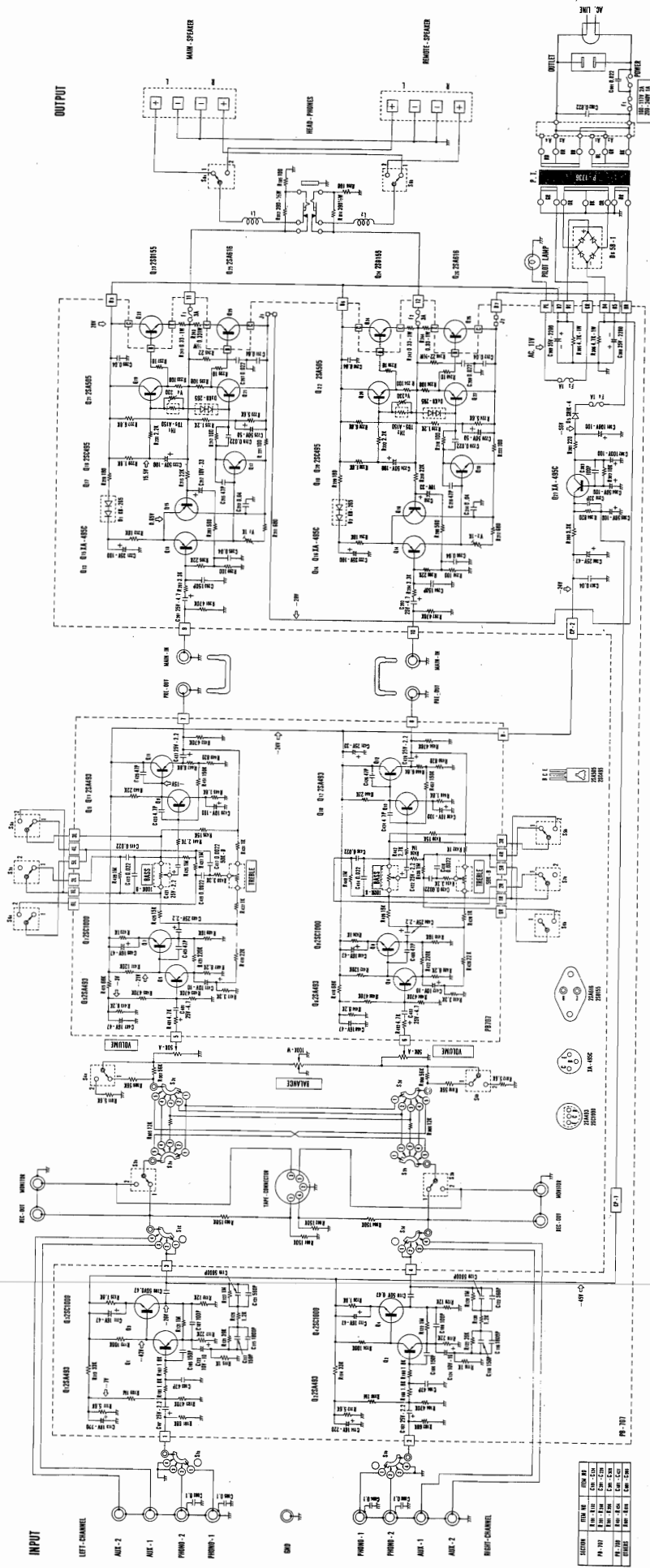

NOTE: PARTS LISTED ARE FOR THE CHASSIS. PARTS LISTED IN PARENTHESES ARE FOR THE FRONT PANEL. PARTS LISTED IN BRACKETS ARE FOR THE REAR PANEL. THE VALUES MAY BE SLIGHTLY DIFFERENT IN PRODUCTION.

RESISTOR VALUES: 1-10% (1-10%), 1-5% (1-5%), 1-1% (1-1%), 1-0.5% (1-0.5%)

CAPACITOR VALUES: 1-10% (1-10%), 1-5% (1-5%), 1-1% (1-1%), 1-0.5% (1-0.5%)

WAVEFORMS: (1) - 100% (100%), (2) - 50% (50%), (3) - 25% (25%), (4) - 12.5% (12.5%)



LUX CORPORATION, JAPAN

head office & factory 2-22, nagahashi-dori, nishinari-ku, osaka phones: 632 0031 cable: luxelect osaka
 international division baba bldg. no.13, 2-23, yushima, bunkyo-ku, tokyo phones: 833 7691 cable: tokluxman tokyo