

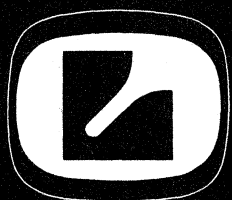

For more Hi-Fi manuals and set-up information  
please visit [www.hifiengine.com](http://www.hifiengine.com)



**LUXMAN**

# **SQ505X**

**SERVICE MANUAL**

## CIRCUIT DESCRIPTION

### POWER SUPPLY

The power supply consists of two parts designed for supply of power to the main amplifier and the preamplifier respectively. For the main amplifier driven by a high current load, silicon diode D602 (5B2) is used and supply voltage values are +42V and -42V.

Power sources other than for the power amplifier are obtainable by D601 (SRIK-4) with the half wave rectification circuit and ripple filter. Supply voltage values at each section are: equalizer stage -43V, tone control and intermediate stages -26V.

### PREAMPLIFIER

The preamplifier consists of an equalizer, an intermediate amplifier and a tone control. The amplifier is so designed that the preamplifier section can be isolated from the power amplifier section if exclusive use of the preamplifier is desired. Preamplifier output signals can be taken out from the PRE OUT terminals. The equalizer adopts the NF circuitry using 3 silicon transistors, 2SA493 (Q201, Q203) 2SC1000 (Q202) per channel and is designed to provide proper equalization on the input signals. Major components to constitute the equalizer are integrated in the printed circuit board PB908. Input signals given through the AUX-1, -2, and -3 terminals bypass the equalizer and are fed directly to the later stages of this amplifier.

Controls arranged after the equalizer are: REC OUT CONNECTOR, TAPE-MONITOR SWITCH, MODE SELECTOR, BALANCE CONTROL and VOLUME CONTROL. The intermediate amplifier consisting of Q301 and Q302 is a flat amplifier adopting 2-stage NF circuitry which is designed to boost the equalizer or AUX. This covers the insertion loss sufficiently by the tone control in the next stage and leads low impedance output to the tone control for its smooth function. The tone control adopts the CB-NF-circuits of transistors, Q401 Q402. Any desired frequency response can be adjusted by the following controls: variable resistor VR401, rotary switch S401 (BASS), and variable resistor VR402, rotary switch S402 (TREBLE). Major components of the intermediate amplifier are arranged on the printed circuit board PB908 and the tone control circuits are integrated in the printed board PB909.

### MAIN AMPLIFIER

The main amplifier adopts direct coupling 2-stage differential driving and pure-complementary circuitry composed by the heat sink with high output power transistors Q107 2SD 188 (NPN), Q108 2SA627 (PNP) (2 transistors per channel), 2 printed circuit boards (one each for both chan-

nels) with several components designed to drive the power transistor and so on.

Q107 and Q108 are independently fixed to the heat sink, which is fixed to the rear panel together with PB910, and coupled with PB908 through 6P lead sockets. The printed circuit boards PB910 consist of the 1st stage differential amplifiers Q101, Q102, 2nd stage differential amplifiers Q103, Q104, the driver transistors Q105, Q106 and other CR components connected with the power transistors for easy replacement or repair of the block.

## SPECIFICATIONS

■ MAIN AMPLIFIER	
RMS POWER	30/30 watts (8Ω both channels driven) 35/35 watts (8Ω one channel driven)
THD	less than 0.04% (8Ω, 30W)
INTER MODULATION DISTORTION	less than 0.04% (8Ω, 30W)
POWER BANDWIDTH	5Hz -- 50,000Hz, -3dB, 0.04%
FREQUENCY RESPONSE	10Hz -- 60,000Hz, less than -1dB
INPUT CONNECTOR	SENSITIVITY: 430mv, IMPEDANCE: 50KΩ
DAMPING FACTOR	30(8Ω), 60(16Ω)
RESIDUAL NOISE	less than 1mv
■ PRE AMPLIFIER	
FREQUENCY RESPONSE	10 -- 50,000Hz, -1dB (aux-1)
THD	less than 0.05% (aux-1, 1KHz, 1v)
INPUT SENSITIVITY	phono-1, phono-2: 2mv aux-1, aux-2, aux-3: 80mv
INPUT IMPEDANCE	phono-1: 30K/50K/100KΩ (selectable) phono-2: 50KΩ aux-1, aux-2, aux-3: 30KΩ
S/N RATIO	phono-1, phono-2: better than 63dB aux-1, aux-2, aux-3: better than 80dB
PERMISSIBLE INPUT VOLTAGE (Max.)	phono: 300mv, aux: indefinite
TONE CONTROL	LUX TYPE NF turnover frequency selection Bass: defeat, 150, 300, 600Hz Treble: defeat, 6K, 3K, 1.5KHz Bass cut: 70Hz (-6dB/oct.) Treble cut: 6KHz (-6dB/oct.) 100Hz (6dB/oct.)
FILTER	
BASS BOOST:	
■ OTHERS	
TRANSISTORS, ETC.	SILICON TRANSISTORS (31), DIODES (2) VARISTERS (4)
ANNEXED CONTROLS	Attenuator (-18dB), speakers switch (main/remote) Tape monitor (2 sets), pre/main amp separator, headphone jack, etc.
POWER CONSUMPTION	130 watts (maximum output, 8Ω, both channels driven)
DIMENSIONS	160mm (6-5/16")H, 450mm (17-3/4")W, 268mm (10-9/16")D
WEIGHT	10 kgs (22 Lbs)

CABINET  
DISASSEMBLY

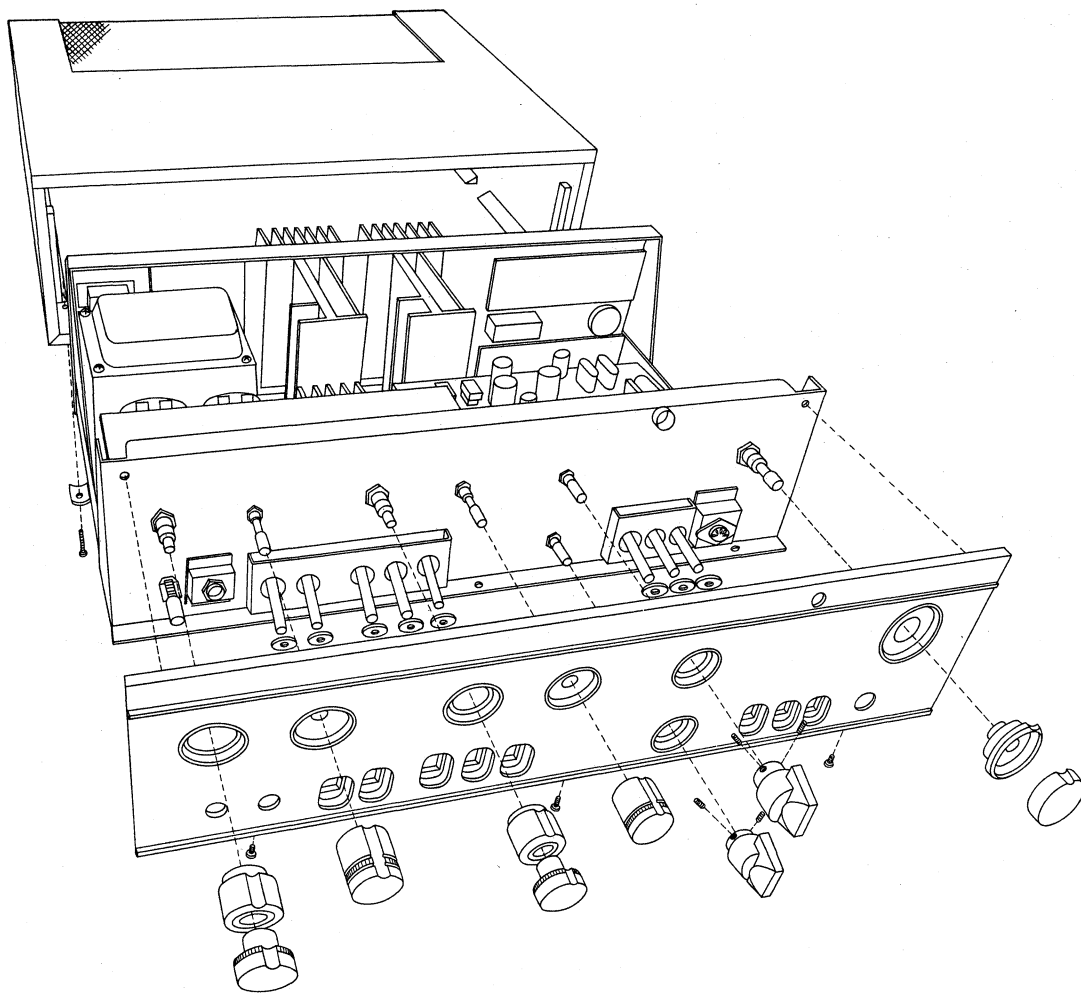

CHASSIS LAYOUT (TOP)

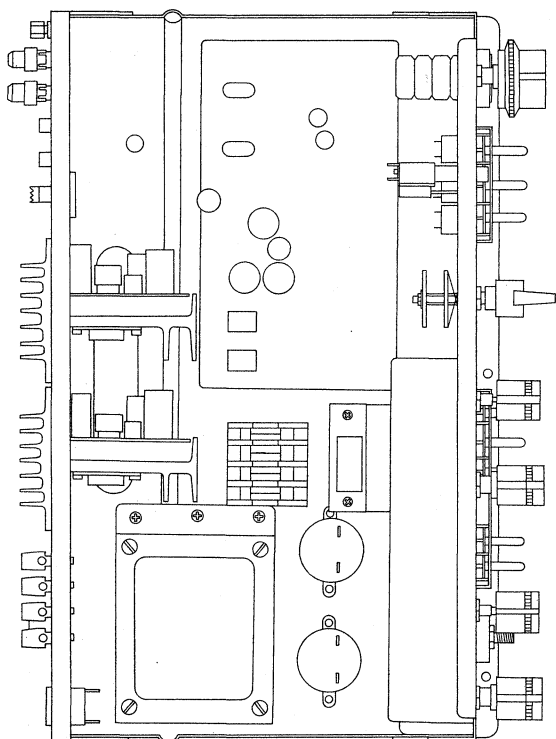

CHASSIS LAYOUT (BOTTOM)

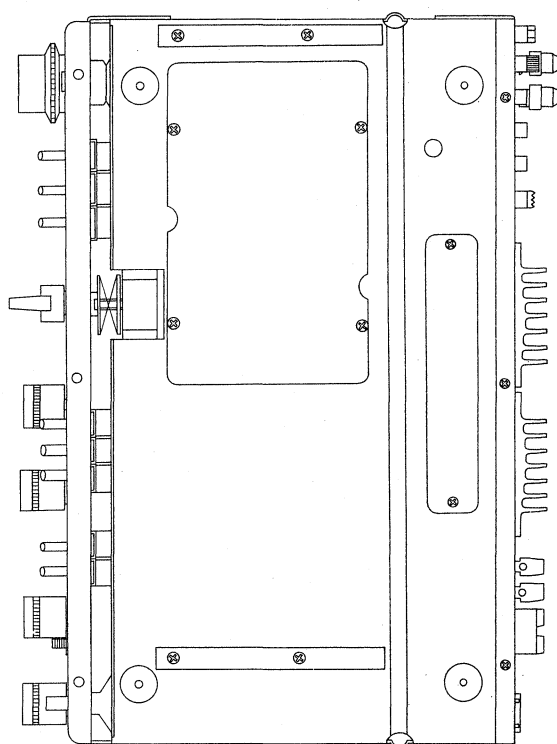

PB908 BOARD

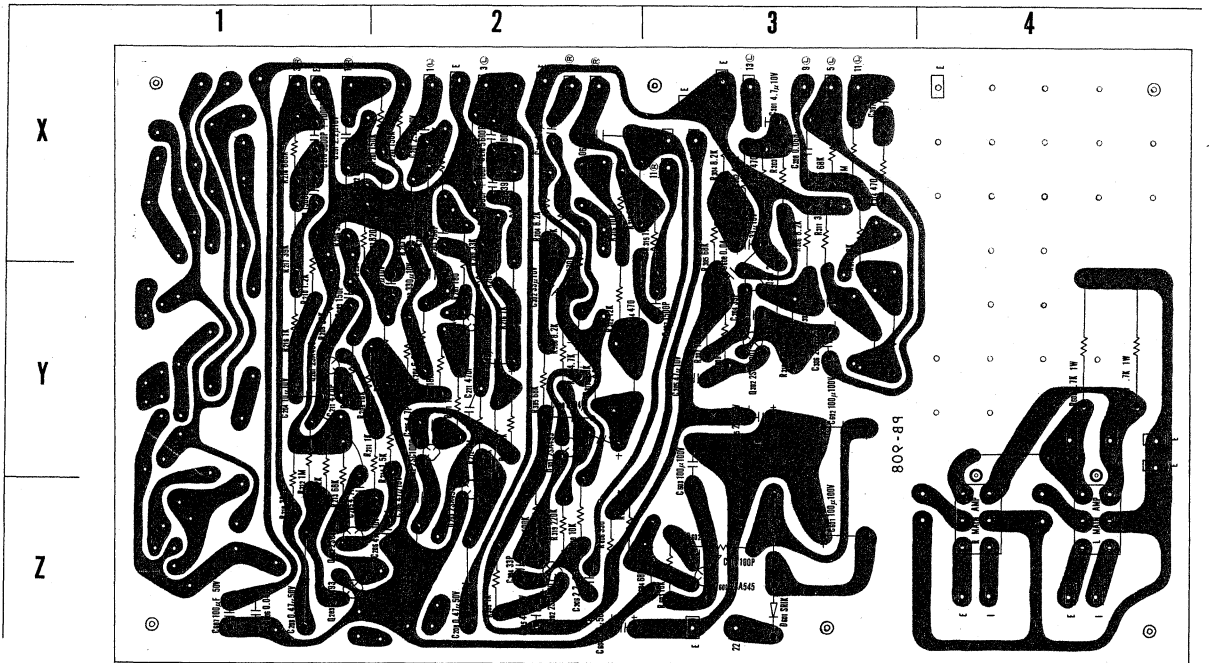

PB909 BOARD

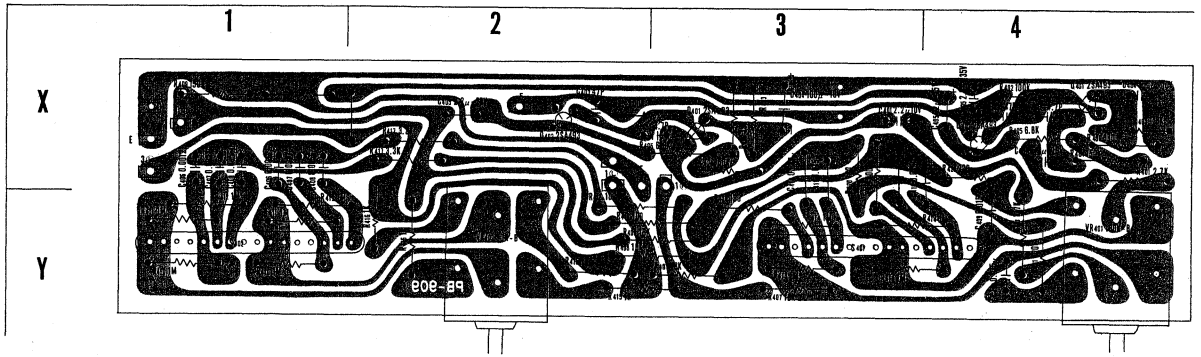

PB910 BOARD

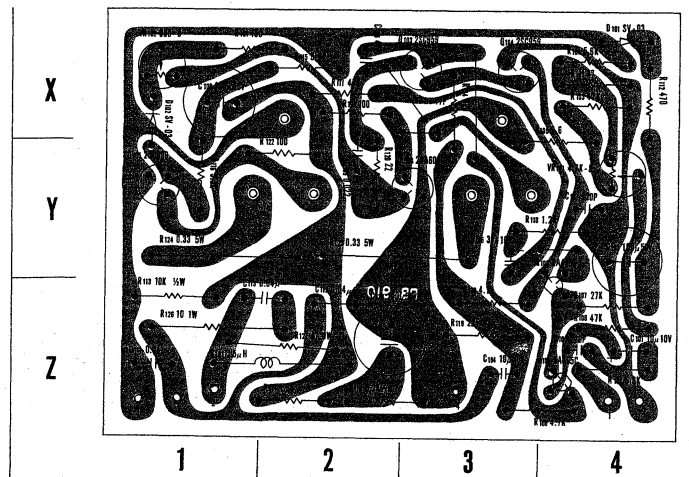

**PB908 COMPONENT LOCATION**

R201 --- X2	X2	R310 --- Z2	Y3	C211 --- Y1	Y2
R202 --- X1	X2	R311 --- Y2	X3		
R203 --- X2	X2	R312 --- Y2	Y3	C301 --- X2	X3
R204 --- X1	Y2	R313 --- X2	X3	C302 --- Y2	X3
R205 --- Y2	Y2	R314 --- Y2	X3	C303 --- Y2	Y3
R206 --- X1	X2	R315 --- Y2	X3	C304 --- Z2	Y3
R207 --- Y1	Y2	R316 --- X2	X3	C305 --- Z2	Y3
R208 --- Y2	Y2	R317		C306 --- Z2	Y3
R209 --- Y1	Y2	R318		C307 --- Y3	X3
R210 --- Y1	Y2	R319 --- Z2	Y3	C308 --- X2	X3
R211 --- Y2	Y2				
R212 --- Y1	Y2	R601 --- Z3		C601 --- Z3	
R213 --- Z1	Y2	R602 --- Z3		C602 --- Y3	
R214 --- Y2	Z2	R603 --- Z3		C603 --- Y3	
R215		R604 --- Z3		C604 --- Z2	
R216 --- Y1	Y2	R605 --- Z2		C605 --- Y3	
R217 --- X1	X2	R606 --- Z2		C606 --- Z1	
R218 --- X1	X2	R607 --- Y4		C607 --- Z1	
R219 --- Z1	X2	R608 --- Y4		C608 --- Y2	X3
R220 --- Y1	Y2			C610 --- Z3	
		C201 --- X1	X2		
R301 --- X2	X3	C202 --- Y2	Y2	Q201 --- Y1	Y2
R302 --- X2	X3	C203 --- Y1	X2	Q202 --- Z1	Y2
R303 --- Y2	X3	C204 --- Y1	Y2	Q203 --- Z1	Z2
R304 --- X2	X3	C205 --- Z1	Y2	Q301 --- Y2	Y3
R305 --- Y2	X3	C206 --- Z2	Z2	Q302 --- Z2	Y3
R306 --- Y2	X3	C207		Q601 --- Z3	
R307 --- Z2	Y3	C208 --- Z1	Z2	D601 --- Z3	
R308		C209 --- X1	X2		
R309 --- Y3	Y3	C210 --- X1	X2		

**PB909 COMPONENT LOCATION**

R401 --- X4	Y4	R414 --- Y3	Y3	C404 --- X3	X4
R402 --- X4	X3	R415 --- Y2	Y2	C405 --- X2	X4
R403 --- X4	X3	R416 --- Y2	Y2	C406 --- X1	X1
R404 --- X4	X3	R417 --- X2	X2	C407 --- X1	X1
R405 --- X4	X3	R418		C408 --- X1	X1
R406 --- X4	X3	R419 --- X3		C409 --- Y4	Y4
R407 --- Y3	Y3	R420 --- X3		C410 --- X3	X3
R408 --- Y3	Y3	R421 --- Y4		C411 --- X3	X3
R409 --- X1	X1	R422 --- X4			
R410 --- Y1	Y1			C605 --- X4	
R411 --- Y1	Y1	C401 --- X3	X4		
R412 --- Y1	Y1	C402 --- X3	X4	Q401 --- X3	X4
R413 --- Y3	Y3	C403 --- X2	X4	Q402 --- X2	X4

**PB910 COMPONENT LOCATION**

R101 --- Z4		R115 --- X2		C101 --- Z4	Q101 --- Z4
R102 --- X4		R116 --- Y1		C102 --- Z4	Q102 --- Z4
R103 --- X4		R117 --- Z2		C103 --- Y4	Q103 --- X3
R104 --- X4		R118 --- Z2		C104 --- Z3	Q104 --- X3
R105 --- Y4		R119 --- Z3		C105 --- Y3	Q105 --- Y1
R106 --- Z4		R120 --- Y2		C106 --- X2	Q106 --- Y3
R107 --- Z4		R121 --- X1		C107 --- Y4	
R108 --- Z3		R122 --- Y2		C108 --- X1	VR101 --- Y4
R109 --- Z3		R123 --- X2		C109 --- Y2	VR102 --- X1
R110 --- Y4		R124 --- Y1		C110 --- Z2	
R111 --- X2		R125 --- Y2		C111 --- Z1	L101 --- Z2
R112 --- X4		R126 --- Z1		C112 --- Z2	
R113 --- Z1		R127 --- Z2		C113 --- Z2	D101 --- X4
R114 --- X3				C114 --- X3	D102 --- X1

## TROUBLESHOOTINGS AND MEASURES

Symptoms	Causes	Measures
1. Pilot lamp does not light	<ol style="list-style-type: none"> <li>1. Defective AC power connector</li> <li>2. Defective power switch</li> <li>3. Cut-off of AC fuse</li> </ol>	<ol style="list-style-type: none"> <li>1. Replace or repair</li> <li>2. Replace or repair</li> <li>3. Replace</li> </ol>
2. Pilot lamp remains lighted even when power switch is off	<ol style="list-style-type: none"> <li>1. Welding of power switch contacts (owing to abnormal high current load)</li> <li>2. Short-circuit on shock prevention condenser (C701)</li> </ol>	<ol style="list-style-type: none"> <li>1. Replace</li> <li>2. Replace</li> </ol>
3. No output signals	<ol style="list-style-type: none"> <li>1. Disorder in power supply circuit, cut-off of rectifier diodes, D602, D601 etc.</li> <li>2. Cut off of transistor Q601</li> <li>3. Blow-out of DC fuse</li> <li>4. Break-down of power transistor (or driver transistor)</li> <li>5. Failure on other components, such as switches (defective contacts), faulty wiring (for example poor withstand voltage on circuit stabilizer condenser, C106), short circuit of earth lead of shielded cable on signal circuit, etc.</li> <li>6. Misuse of amplifier               <ol style="list-style-type: none"> <li>i. PRE-OUT &amp; MAIN-IN connectors are not properly linked.</li> <li>ii. FUNCTION SWITCH not selected at proper position</li> <li>iii. MONITOR SWITCH S705a, S705b is on.</li> <li>iv. Incomplete speaker cords connection.</li> <li>v. Failure on program source equipment, such as record player, tuner, tape recorder, etc.</li> </ol> </li> </ol>	<ol style="list-style-type: none"> <li>1. Check and correct</li> <li>2. Check and correct</li> <li>3. Replace DC fuse. Caution, however, if blowout takes place even after fuse replacement, thorough check on causes inducing such fuse blow-out.</li> <li>4. Replace. In this case DC fuse may have been blown out too.</li> <li>5. Check and correct. In some cases, playback from one on the both channels is possible.               <ol style="list-style-type: none"> <li>i. On the separator</li> <li>ii. Correct.</li> <li>iii. Off the switch.</li> <li>iv. Correct the connection.</li> <li>v. Repair such malfunctioning program source equipment.</li> </ol> </li> </ol>

Symptoms	Causes	Measures
<p>4. Tone quality is abnormal</p>	<p>1. Considerable distortion</p> <ul style="list-style-type: none"> <li>i. Abnormal functioning of transistors</li> <li>ii. Oscillation ... specifications of components parts, such as coupling condensers, deviate from rated specified values. Layout of earth lead is not correctly made, etc.</li> <li>iii. Distortion caused by external audio components</li> </ul> <p>2. Unbalanced volume</p> <ul style="list-style-type: none"> <li>i. Error in coupling movement between variable resistor VR701a, VR701b for volume control and variable resistor VR703a, VR703b for level set.</li> <li>ii. Drop out of negative feed back circuit in one of the channels, such as defective condenser C303 etc.</li> <li>iii. Incomplete switch contacts, etc.</li> <li>iv. Defects of other component parts. Unbalance with external audio components.</li> </ul> <p>3. Inferior frequency response</p> <ul style="list-style-type: none"> <li>i. Defective coupling condensers</li> <li>ii. Defective condenser in tone control circuit.</li> <li>iii. Excessive length of shielded cable for connection with external audio components.</li> </ul> <p>4. Excessive cross-talk</p> <ul style="list-style-type: none"> <li>i. Layout of components parts too close each other -- abnormal.</li> <li>ii. Oscillation is caused.</li> </ul> <p>5. Noises. Hum Very frequently, causes of hum pick-</p>	<ul style="list-style-type: none"> <li>i. Check for specified load voltages.</li> <li>ii. Replace or repair.</li> <li>iii. Correct such distortion source.</li> <li>i. Correct such error</li> <li>ii. Replace defective parts.</li> <li>iii. Replace or correct.</li> <li>iv. Check and correct.</li> <li>i. Check and replace.</li> <li>ii. Check and replace.</li> <li>iii. Shorten the length.</li> <li>i. Correct the parts layout (refer to parts Layout Diagrams in this Service Manual).</li> <li>ii. Check and correct.</li> </ul>



Symptoms	Causes	Measures
	<p>up consists in external program source equipment (such as record player). If hum is caused even after disconnection of input connectors from program sources, then the amplifier should be checked -- Cut off or defect of capacitors, C601, C602 etc. in power supply circuit, or one of the rectifier transistor diodes, D601, D602 or Q601.</p> <p>Also, hum induction from AC leads because of incorrect wiring.</p> <p>Irregular noises</p> <ul style="list-style-type: none"> <li>i. Noise figure of transistor is deteriorated.</li> <li>ii. Capacitance of input condensers at any stage deviates from specified values.</li> <li>iii. Noise from resistors</li> </ul> <p>Noises in case of switch selection. Leak current of coupling condenser exceeds the limit.</p>	<ul style="list-style-type: none"> <li>i. Replace.</li> <li>ii. Check and replace.</li> <li>iii. Check and replace.</li> </ul> <p>3. Replace.</p>
<p>5. Operation of protective circuit</p>	<ul style="list-style-type: none"> <li>1. Causes at output loads side. When special low impedance speakers such as electro-static speakers are used, or when multiple numbers of speakers are connected in parallel, the amplifier is driven under rigorous operating conditions. This therefore frequently causes to operate the protective circuit.</li> <li>2. Errors in use. If the amplifier is operated while output loads are accidentally short circuited, the protective circuit functions.</li> <li>3. Presetting of the protective circuit operation is incorrect -- specification of capacitors, resistors, etc. in the protective circuit deviate from the specified values.</li> </ul>	<ul style="list-style-type: none"> <li>1. In such cases, it is recommended to insert resistors (say 2 5W) in series to speaker leads.</li> <li>2. Thoroughly check output terminals, speaker leads to eliminate such short circuiting.</li> <li>3. Check, replace or correct.</li> </ul>

## PARTS LIST

### MECHANICAL

Sub panel	1
Fixing metal (G) for lever switch	1
Fixing metal (H) for lever switch	1
Fixing metal for phone jack	1
Fixing metal for DIN connector	1
Fixing metal for pilot lamp	1
Fixing metal for sub panel	1
Chassis	1
Chassis cover (large)	1
Chassis cover (small)	1
Stand (large)	8
Stand (small)	2
Fixing metal for power transformer	2
Speaker switch shield metal	1
Shield metal for power source	1
Rear panel	1
Switch rubber	8
Roll pipe	8
GND terminals for lever switch	4
PCV plate for chassis	2
Fixing plate for power cord (Only for these territories where detachable cord is prohibited)	1

### DESIGNING/OUTER APPEARANCE

Front panel	1
Decoration panel	1
Wooden case	1
Ventillation plate for wood case	1
Switch knob metal	2
Switch knob mould	2
Single knob	2
Volume knob	1
Balancer knob	1
Inner axis knob	2
Outer axis knob	2
Push button for power switch	1
Knob fibre	1
Switch escutcheon	1

### OVERALL COMPONENTS SUB PANEL, REAR PANEL & CHASSIS

Item			
Phone jack	SQ7702		1
Toggle switch	LT22N		7
Rotary switch	Y245		2
Power switch	UEH12BF		1
Variable resistor	50K $\Omega$ 100K $\Omega$ AC		1
Tape connector DIN	S-I 8191		1
Pilot lamp	6.3V 0.15A		1
Pilot lamp socket	S-4108		1
Lug plate	L-590		1
Film condensor	0.068 $\mu$ F 50V $\pm$ 10%		2
Fixed resistor	1M $\Omega$ 1/4W $\pm$ 10%		2
"	150K "		4
"	47K "		2
"	18K "		2
"	12K "		2
"	6.8K "		2

Fixed resistor	100 1/4W $\pm$ 10%		2
"	470 1W $\pm$ 5%		2
Tube for pilot lamp			1
Film condensor	0.1 $\mu$ F 50V $\pm$ 10%		1
Selector switch (small)	S18 - 143		1
Input pin jack	10P Q-9401		1
"	12P SQ-3850		1
Pin plug	US Type		4
Silde switch	SL-222B4		1
Output terminal plate	SQ-9443		2
Fuse holder	S-N2052		1
AC outlet	S-I 6407		3
AC input connector	S-I 6405		1
Fuse	3A		1
AC pass condensor	0.22 $\mu$ F AC450V		3
GND terminals	VB-2, VN-2, VW-2		1 set
Fixed resistor	1M $\Omega$ 1/4W $\pm$ 10%		12
"	100K "		4
"	47K "		2
Ceramic condensor	0.1 $\mu$ F 12V		4
Power transformer	P-1720		1
Voltager selector	9208 9209		1 set
Fuse holder	F-3321		1
Electrolytic condensor	3300 $\mu$ F 35V		2
Fuse	5A		2
"	2A		2
GND lug	B5		7
Diode	200V 4.5A 5B2		1
Lug plate	1L2P large		1
Toggle switch	LT-22N processed		1

### ACCESSORIES

Power cord			1
Fuse	5A		1
"	2A		1
Pilot lamp	6.3V 0.15A		1

### MAIN AMPLIFIER PB910

Printed circuit board	PB910 XXXP		1
Heat sink			2
Small radiator			8
Transistor	2SD188		2
"	2SA627		2
"	2SC959		6
"	2SA606		2
"	XA495C		4
Varistor	SV-03		4
Power Tr. mica biss, spring washer			4 sets
Power transistor socket	S2-110B		4
Coil	1.5 $\mu$ H		2
Semi-Fixed resistor	4.7K $\Omega$ B type 10 $\phi$ SR19R		2
"	330 $\Omega$ "		2
Driver Tr. ped	6J-5		8
Combination line connector	6P		2
Electrolytic condensor	100 $\mu$ F 50V, 50VBSN-100		6
"	33 $\mu$ F 10V, 30VBSN-33		2
Film condensor	0.022 $\mu$ F 50V $\pm$ 10%		6
Ceramic condensor	47pF 50V $\pm$ 10%		4

Ceramic condensor	220pF 50V ±10%	4
Electrolytic condensor	10 μF 50V 50VBSN-10	2
Pins for comb. line		12
Sockets for comb. line		12
Tantalum condensor	10 μF 10V ±20%	2
Ceramic condensor	0.04 μF 50V	2
Resistors	47KΩ 1/4W ±10% R-1/4AGK	4
"	27K " "	2
"	5.6K " "	8
"	4.7K " "	4
"	3.3K " "	2
"	1.8K " "	2
"	1.2K " "	2
"	470 " "	2
"	220 " "	2
"	330 " "	2
"	100 " "	4
"	47 " "	4
"	22 " "	2
"	10KΩ 1/2W ±5% R-1/2AG.J	2
"	8.2K " " "	2
"	22 " " "	2
"	10 1W " R-1 AG.J	2
"	47 1/2W ±5% R-1/2AG.J	2
"	0.33Ω 5W square shaped	4

**TONE CONTROL PB909**

Printed circuit board	XXXXP PB909	1
Variable resistor	dual friction type 5KΩ	1
Variable resistor	dual friction type 10KΩ	1
Selector switch	FP124	2
Transistor	2SA640L (2SA493GR)	4
Film condensor	0.047 μF 50V ±10%	2
"	0.015 μF " " (single lead)	4
"	0.0056 μF " " ( " )	2
"	0.0027 μF " " ( " )	2
"	0.0012 μF " " ( " )	2
Ceramic condensor	47pF 50V ±10%	2
"	4.7pF " "	2
Alminium electrolytic condensor	2.2 μF 25V ±20%	2
"	2.2 μF 10V "	2
Electrolytic condensor	100 μF 10V 10VBSN-100	2
"	100 μF 35V 35VBSN-100	1
Lapping terminals	10 series fasten receptacle	9
"	10 series fasten tab	9
Resistors	1MΩ 1/4W ±10% R-1/4 AG.K	10
"	150K " " "	4
"	100K " " "	2
"	18K " " "	4
"	6.8K " " "	2
"	3.3K " " "	2
"	2.7K " " "	2
"	1.8K " " "	2
"	1K " " "	4
"	390 " " "	2
"	220 " " "	1
"	120 " " "	1
"	100 " " "	5

**PRE AMPLIFIER POWER SUPPLY PB908**

Printed circuit board	XXXXP PB908	1
-----------------------	-------------	---

Print terminals		38
Diode	SR1 K-4 200V 1A	1
Transistor	2SA545	1
"	2SA640L (2SA493GR)	6
"	2SC1222F (2SC1000GR)	4
Electrolytic condensor	100 μF 100V 100VBSN-100	3
"	100 μF 50V 50VBSN-100	2
"	47 μF 16V 16VBSN-47	6
"	10 μF 16V 16VBSN-10	2
"	330 μF 10V 10VBSN-330	2
"	33 μF 10V 10VBSN-33	2
Alminium solid electrolytic condensor	4.7 μF 10V	2
"	2.2 μF 10V	2
"	2.2 μF 25V	2
Film condensor	0.47 μF 50V ±10%	2
"	0.068 μF 50V "	2
"	0.0056 μF 50V " (single lead)	2
"	0.0015 μF " ( " )	4
Styrol condensor	470pF 50V "	2
Ceramic condensor	150pF 50V ±10%	2
"	100pF "	3
"	33pF "	2
"	4.7pF "	2
"	0.04 μF 50V	3
Film condensor	0.001 μF 50V ±10% (single lead)	2
Resistors	4.7KΩ 1W ±5% R-1AGJ	2
"	1MΩ 1/4W ±5% R-1/4SGJ (low noise)	2
"	680K 1/4W ±5% (low noise) R-1/4SGJ	2
"	33K " " "	4
"	18K " " "	2
"	1.2K " " "	2
"	1MΩ 1/4W ±10% R-1/4AG.K	2
"	470K " " "	4
"	330K " " "	2
"	220K " " "	2
"	150K " " "	2
"	100K " " "	2
"	68K " " "	6
"	39K " " "	2
"	680K " " "	2
"	10K " " "	7
"	8.2K " " "	6
"	4.7K " " "	2
"	3.9K " " "	2
"	3.3K " " "	2
"	2.7K " " "	1
"	1.5K " " "	2
"	1K " " "	6
"	680 " " "	1
"	470 " " "	2
"	330 " " "	1
"	180 " " "	2
"	100 " " "	1
"	33 " " "	1
"	12K " " "	2
"	820KΩ 1/4W ±10% (low noise)	2
"	6.8K " ( " )	2

### BASS TONE CONTROL

Turn-over (Roll-off) Frequency; 150Hz

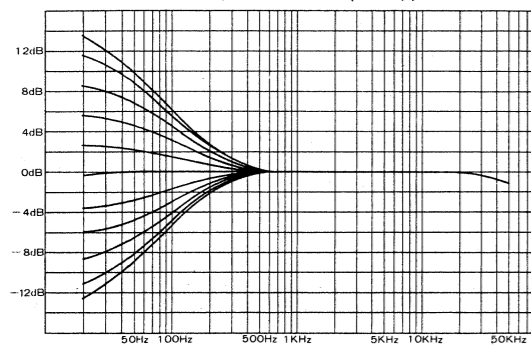

### TREBLE TONE CONTROL

Turn-over (Roll-off) Frequency; 6KHz

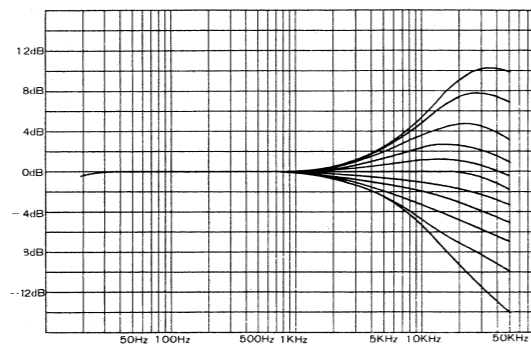

### POWER BANDWIDTH 8Ω load 0dB; 30W

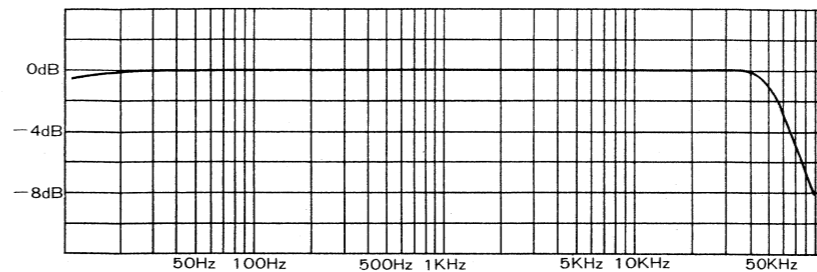

### PHONO INPUT VOLTAGE

Input; Phono-2, measured at 1W clipping point

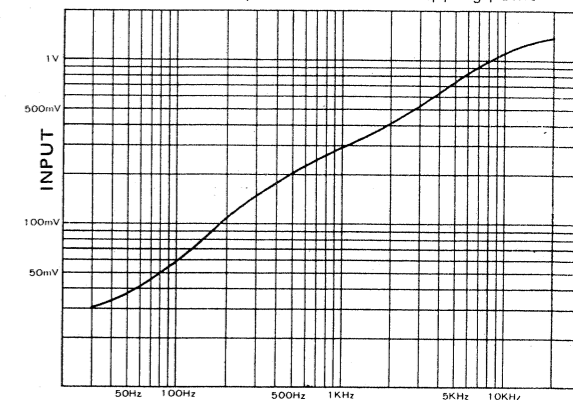

### BASS TONE CONTROL

Turn-over (Roll-off) Frequency; 300Hz

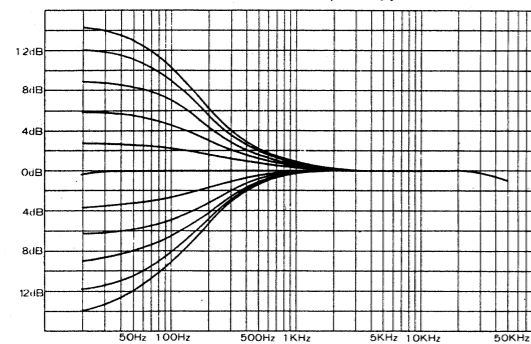

### TREBLE TONE CONTROL

Turn-over (Roll-off) Frequency; 3KHz

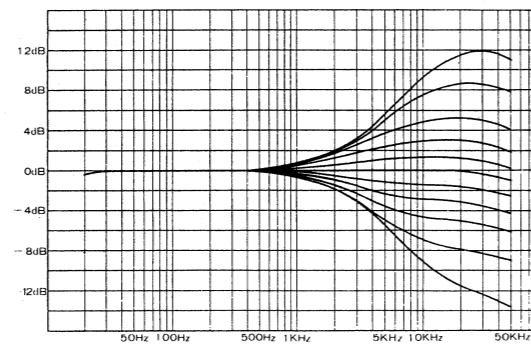

### DAMPING FACTOR 8Ω load 1W output

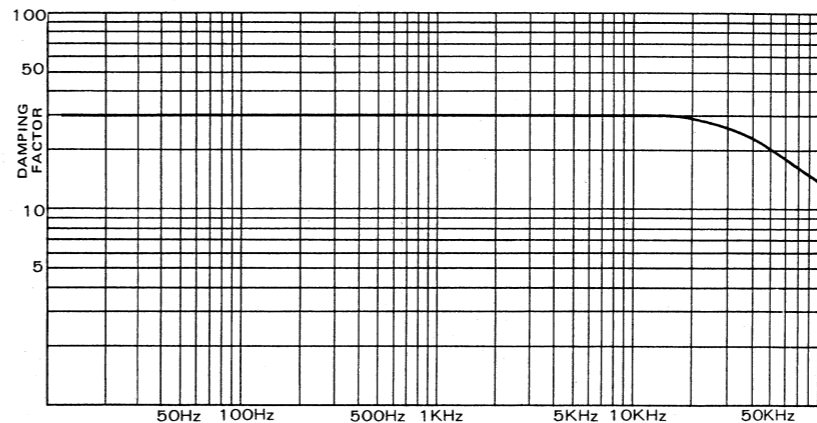

### EQUALIZER

Output; Rec. out Terminals

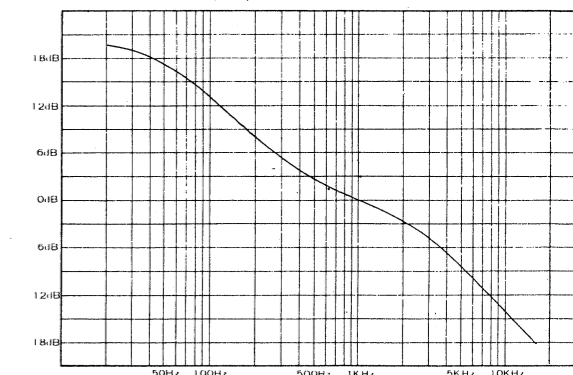

### BASS TONE CONTROL

Turn-over (Roll-off) Frequency; 600Hz

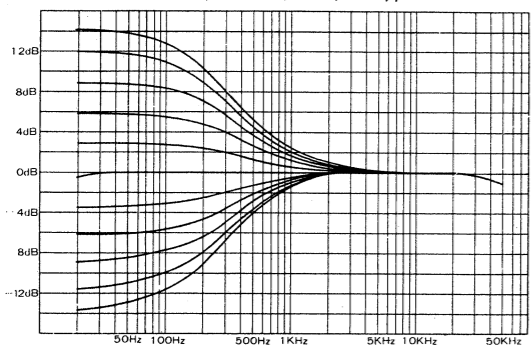

### TREBLE TONE CONTROL

Turn-over (Roll-off) Frequency; 1.5KHz

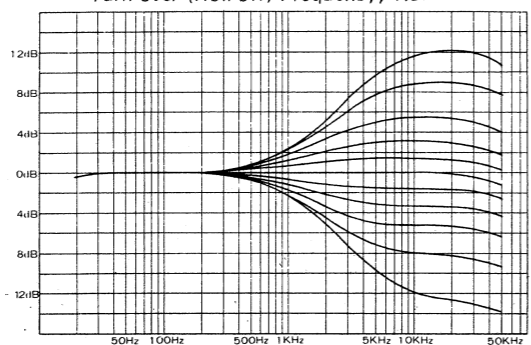

### INTER-MODULATION DISTORTION

Input; Main in, Frequency and Modulation Ratio 70Hz; 7KHz=4 : 1

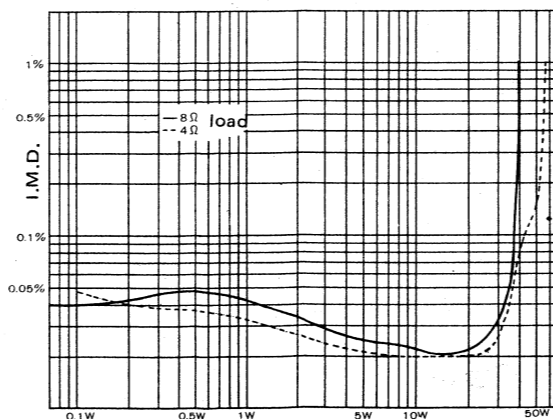

### NOISE + HARMONIC DISTORTION

Input; Main in, 8Ω load, incl. oscillator distortion 0.03%

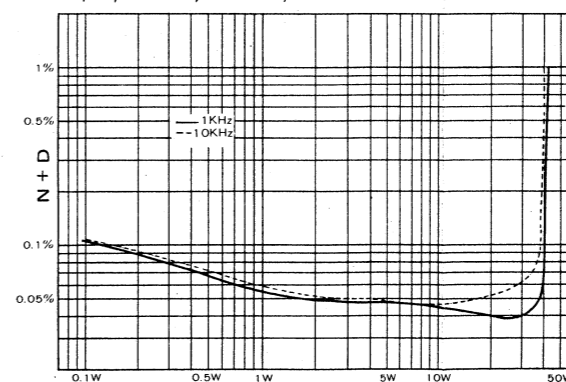

### NOISE + HARMONIC DISTORTION

Input; Main in, 4Ω load, incl. oscillator distortion 0.03%

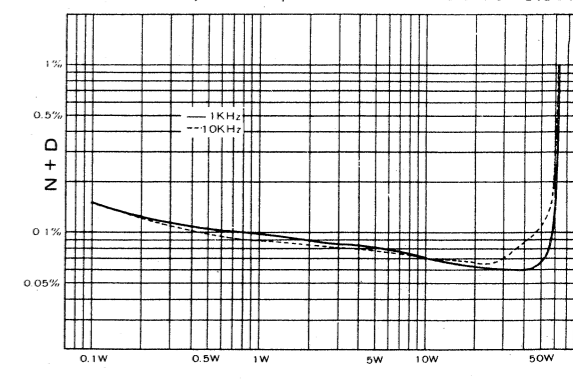

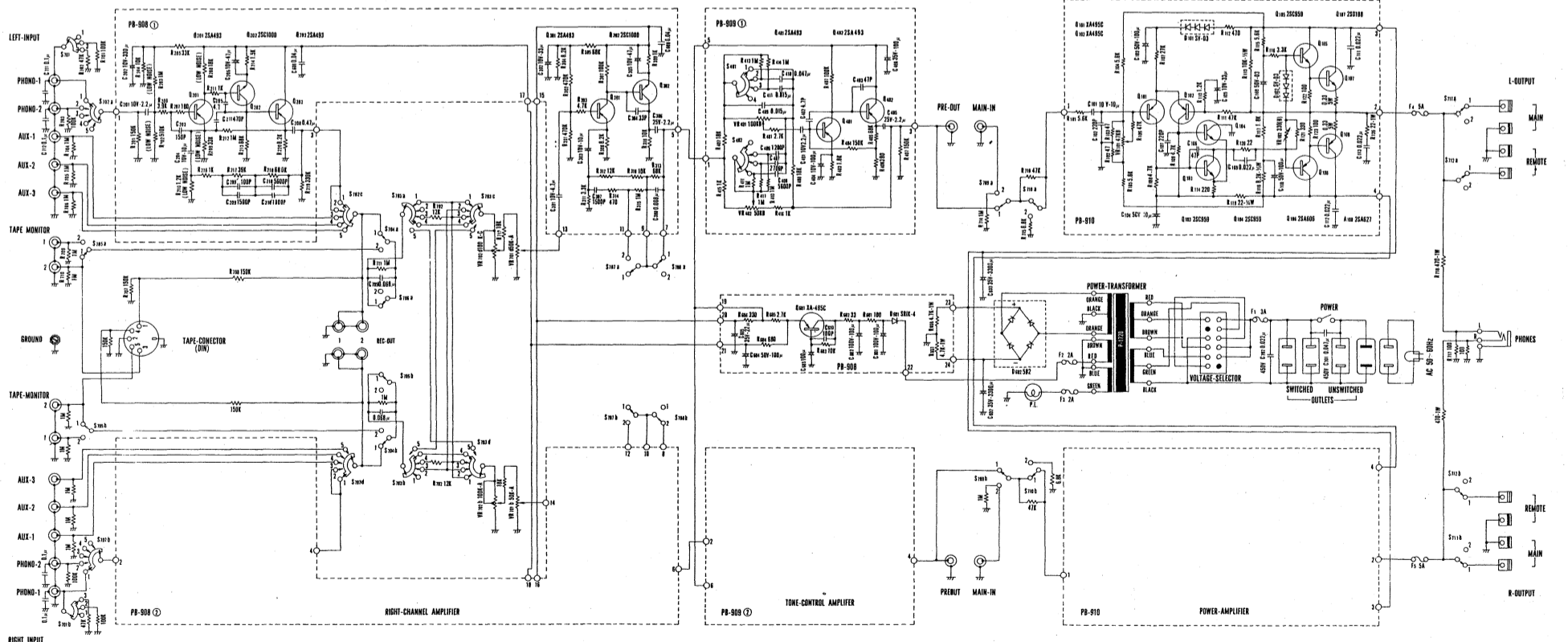

SW 2, 3, 4, 5, 6, 7, 8, 9, 10, 11, 12, 13, 14, 15, 16, 17, 18, 19, 20, 21, 22, 23, 24, 25, 26, 27, 28, 29, 30, 31, 32, 33, 34, 35, 36, 37, 38, 39, 40, 41, 42, 43, 44, 45, 46, 47, 48, 49, 50, 51, 52, 53, 54, 55, 56, 57, 58, 59, 60, 61, 62, 63, 64, 65, 66, 67, 68, 69, 70, 71, 72, 73, 74, 75, 76, 77, 78, 79, 80, 81, 82, 83, 84, 85, 86, 87, 88, 89, 90, 91, 92, 93, 94, 95, 96, 97, 98, 99, 100, 101, 102, 103, 104, 105, 106, 107, 108, 109, 110, 111, 112, 113, 114, 115, 116, 117, 118, 119, 120, 121, 122, 123, 124, 125, 126, 127, 128, 129, 130, 131, 132, 133, 134, 135, 136, 137, 138, 139, 140, 141, 142, 143, 144, 145, 146, 147, 148, 149, 150, 151, 152, 153, 154, 155, 156, 157, 158, 159, 160, 161, 162, 163, 164, 165, 166, 167, 168, 169, 170, 171, 172, 173, 174, 175, 176, 177, 178, 179, 180, 181, 182, 183, 184, 185, 186, 187, 188, 189, 190, 191, 192, 193, 194, 195, 196, 197, 198, 199, 200, 201, 202, 203, 204, 205, 206, 207, 208, 209, 210, 211, 212, 213, 214, 215, 216, 217, 218, 219, 220, 221, 222, 223, 224, 225, 226, 227, 228, 229, 230, 231, 232, 233, 234, 235, 236, 237, 238, 239, 240, 241, 242, 243, 244, 245, 246, 247, 248, 249, 250, 251, 252, 253, 254, 255, 256, 257, 258, 259, 260, 261, 262, 263, 264, 265, 266, 267, 268, 269, 270, 271, 272, 273, 274, 275, 276, 277, 278, 279, 280, 281, 282, 283, 284, 285, 286, 287, 288, 289, 290, 291, 292, 293, 294, 295, 296, 297, 298, 299, 300, 301, 302, 303, 304, 305, 306, 307, 308, 309, 310, 311, 312, 313, 314, 315, 316, 317, 318, 319, 320, 321, 322, 323, 324, 325, 326, 327, 328, 329, 330, 331, 332, 333, 334, 335, 336, 337, 338, 339, 340, 341, 342, 343, 344, 345, 346, 347, 348, 349, 350, 351, 352, 353, 354, 355, 356, 357, 358, 359, 360, 361, 362, 363, 364, 365, 366, 367, 368, 369, 370, 371, 372, 373, 374, 375, 376, 377, 378, 379, 380, 381, 382, 383, 384, 385, 386, 387, 388, 389, 390, 391, 392, 393, 394, 395, 396, 397, 398, 399, 400, 401, 402, 403, 404, 405, 406, 407, 408, 409, 410, 411, 412, 413, 414, 415, 416, 417, 418, 419, 420, 421, 422, 423, 424, 425, 426, 427, 428, 429, 430, 431, 432, 433, 434, 435, 436, 437, 438, 439, 440, 441, 442, 443, 444, 445, 446, 447, 448, 449, 450, 451, 452, 453, 454, 455, 456, 457, 458, 459, 460, 461, 462, 463, 464, 465, 466, 467, 468, 469, 470, 471, 472, 473, 474, 475, 476, 477, 478, 479, 480, 481, 482, 483, 484, 485, 486, 487, 488, 489, 490, 491, 492, 493, 494, 495, 496, 497, 498, 499, 500, 501, 502, 503, 504, 505, 506, 507, 508, 509, 510, 511, 512, 513, 514, 515, 516, 517, 518, 519, 520, 521, 522, 523, 524, 525, 526, 527, 528, 529, 530, 531, 532, 533, 534, 535, 536, 537, 538, 539, 540, 541, 542, 543, 544, 545, 546, 547, 548, 549, 550, 551, 552, 553, 554, 555, 556, 557, 558, 559, 560, 561, 562, 563, 564, 565, 566, 567, 568, 569, 570, 571, 572, 573, 574, 575, 576, 577, 578, 579, 580, 581, 582, 583, 584, 585, 586, 587, 588, 589, 590, 591, 592, 593, 594, 595, 596, 597, 598, 599, 600, 601, 602, 603, 604, 605, 606, 607, 608, 609, 610, 611, 612, 613, 614, 615, 616, 617, 618, 619, 620, 621, 622, 623, 624, 625, 626, 627, 628, 629, 630, 631, 632, 633, 634, 635, 636, 637, 638, 639, 640, 641, 642, 643, 644, 645, 646, 647, 648, 649, 650, 651, 652, 653, 654, 655, 656, 657, 658, 659, 660, 661, 662, 663, 664, 665, 666, 667, 668, 669, 670, 671, 672, 673, 674, 675, 676, 677, 678, 679, 680, 681, 682, 683, 684, 685, 686, 687, 688, 689, 690, 691, 692, 693, 694, 695, 696, 697, 698, 699, 700, 701, 702, 703, 704, 705, 706, 707, 708, 709, 710, 711, 712, 713, 714, 715, 716, 717, 718, 719, 720, 721, 722, 723, 724, 725, 726, 727, 728, 729, 730, 731, 732, 733, 734, 735, 736, 737, 738, 739, 740, 741, 742, 743, 744, 745, 746, 747, 748, 749, 750, 751, 752, 753, 754, 755, 756, 757, 758, 759, 760, 761, 762, 763, 764, 765, 766, 767, 768, 769, 770, 771, 772, 773, 774, 775, 776, 777, 778, 779, 780, 781, 782, 783, 784, 785, 786, 787, 788, 789, 790, 791, 792, 793, 794, 795, 796, 797, 798, 799, 800, 801, 802, 803, 804, 805, 806, 807, 808, 809, 810, 811, 812, 813, 814, 815, 816, 817, 818, 819, 820, 821, 822, 823, 824, 825, 826, 827, 828, 829, 830, 831, 832, 833, 834, 835, 836, 837, 838, 839, 840, 841, 842, 843, 844, 845, 846, 847, 848, 849, 850, 851, 852, 853, 854, 855, 856, 857, 858, 859, 860, 861, 862, 863, 864, 865, 866, 867, 868, 869, 870, 871, 872, 873, 874, 875, 876, 877, 878, 879, 880, 881, 882, 883, 884, 885, 886, 887, 888, 889, 890, 891, 892, 893, 894, 895, 896, 897, 898, 899, 900, 901, 902, 903, 904, 905, 906, 907, 908, 909, 910, 911, 912, 913, 914, 915, 916, 917, 918, 919, 920, 921, 922, 923, 924, 925, 926, 927, 928, 929, 930, 931, 932, 933, 934, 935, 936, 937, 938, 939, 940, 941, 942, 943, 944, 945, 946, 947, 948, 949, 950, 951, 952, 953, 954, 955, 956, 957, 958, 959, 960, 961, 962, 963, 964, 965, 966, 967, 968, 969, 970, 971, 972, 973, 974, 975, 976, 977, 978, 979, 980, 981, 982, 983, 984, 985, 986, 987, 988, 989, 990, 991, 992, 993, 994, 995, 996, 997, 998, 999, 1000.

**LUX CORPORATION, JAPAN**

head office & factory 2-22, nagahashi-dori, nishinari-ku, osaka phones: 632 0031 cable: luxselect osaka  
 international division baba bldg. no.13, 2-23, yushima, bunkyo-ku, tokyo phones: 833 7691 cable: tokluxman tokyo



**SQ-505X**