

**HiFi ENGINE®**

For more Hi-Fi manuals and set-up information  
please visit [www.hifiengine.com](http://www.hifiengine.com)

**OPERATING  
MANUAL**

**SCOTT STEREO TUNER**

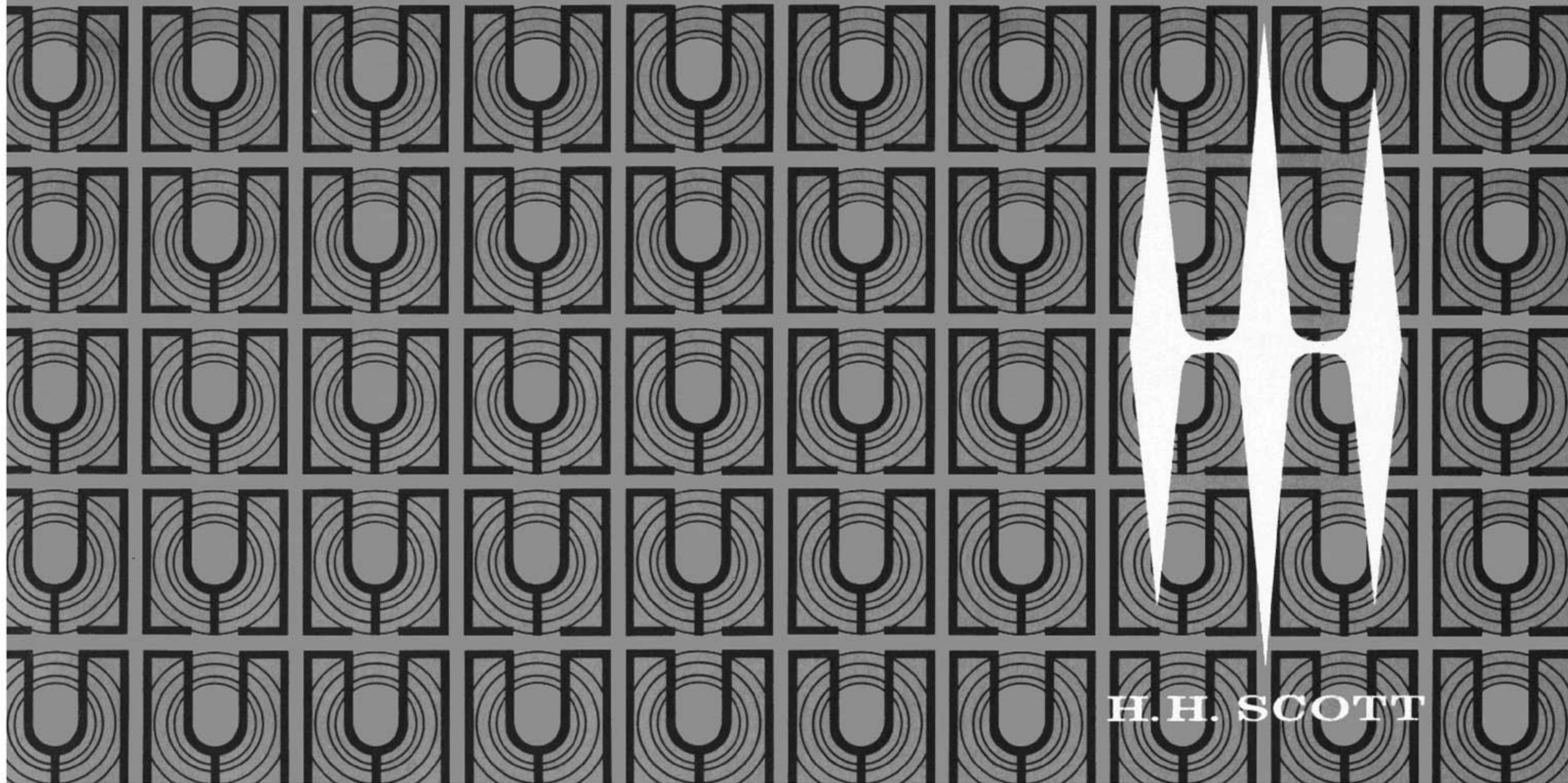

**H.H. SCOTT**

# LOOK HOW EASY IT IS TO OPERATE YOUR 370B/LT-111 STEREO TUNER

This simplified photo-guide shows how to use your new tuner. A similar guide on the inside back cover shows how to connect the tuner to the rest of your music system. However,

we strongly suggest that you read the complete instruction book thoroughly. Only then will you get the utmost enjoyment and maximum performance from this superb instrument.

## TUNING INDICATOR

For best listening, adjust the tuning dial so that the vertical dark band in the center is narrowest. (see pages 5 and 8)

## FM TUNING DIAL

To select an FM station (see page 8)

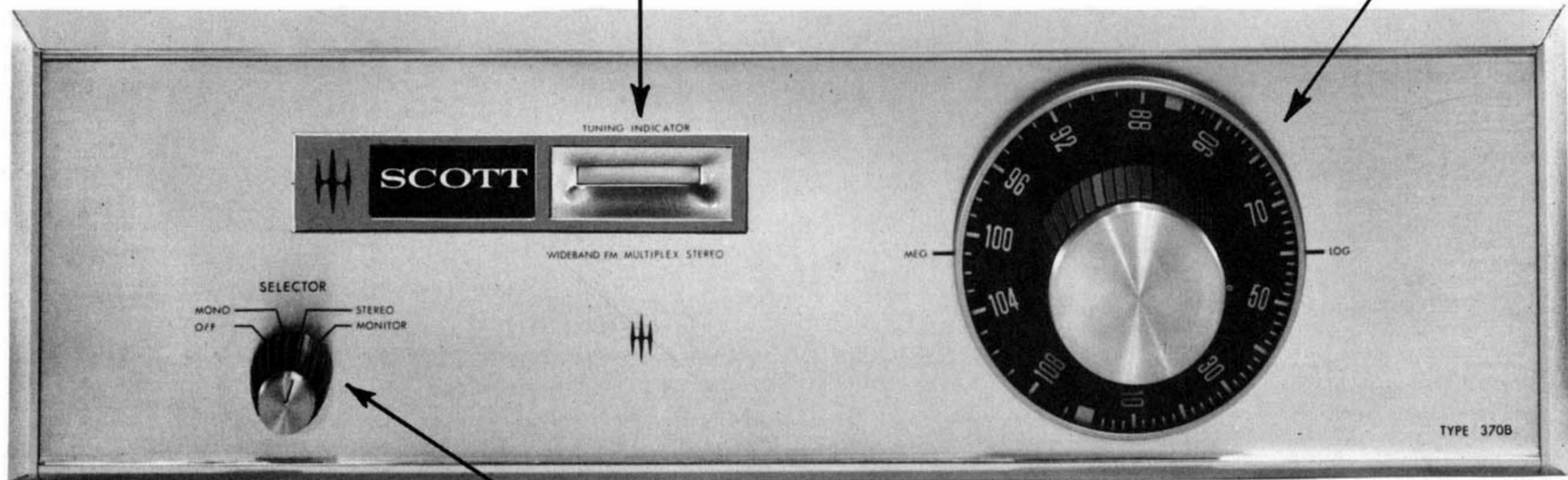

## SELECTOR

Off — turns the tuner off (see page 7)  
Mono — To receive FM monophonic broadcasts (see page 10)  
Stereo — To receive FM stereo broadcasts (see page 9)

Monitor — Helps you locate a station broadcasting in stereo. Turn Selector to Monitor position and tune slowly across the dial. When you hear a steady tone, return the switch to Stereo. (see page 10)

**LT-111 uses different panel but has same controls as 370 pictured above.**

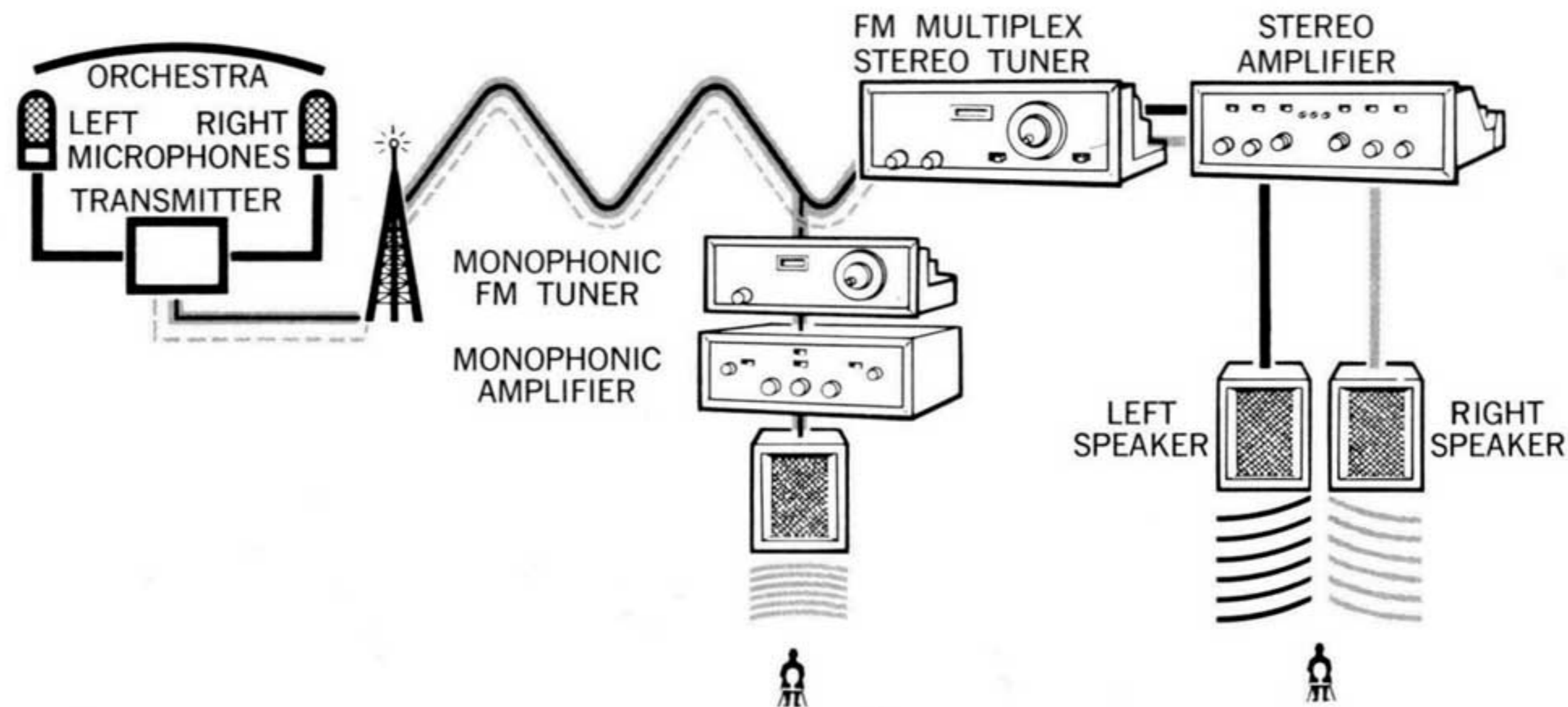

## HOW FM STEREO (MULTIPLEX) WORKS

Multiplexing is a method of broadcasting two or more signals from one FM transmitter. This means that a *single* FM station can broadcast *both* the left and right channels of a stereophonic program from records, tapes, or live performances. To enjoy FM stereo programs, you need a stereo amplifier (or two monophonic amplifiers) and two speaker systems, in addition to your new Scott tuner.

### How Multiplex Stereo Works

Humans are capable of hearing sounds between about 20 and 20,000 cycles per second. Any sound above 20,000 cycles per second is referred to as "supersonic" because it is above the range of human hearing.

Most good FM tuners are capable of reproducing these supersonic frequencies above 20,000 cycles per second ("cps" for short). Though you cannot hear them, these supersonic frequencies are used very effectively for multiplex. At a frequency of 38,000 cycles per second (cps), high above the sounds you can hear, the second (stereo information) signal is added on. While you can't hear this second signal, your FM tuner can, and, if equipped for multiplex, will convert this into sound you *can* hear — stereo sound.

This second signal is *not* either the left or right channel. If it were, a listener with a monophonic tuner would hear only half of the program. Instead (see diagram below), a method is used that provides the full monophonic signal (left plus right) for the listener with a regular FM tuner, and stereo for the listener with multiplex equipment. The stereo quality depends on how well the multiplex

tuner handles the second signal (stereo information). If very little of the second signal is being properly processed, there will be poor stereo quality (poor separation between the left and right channels). Simply having sound from both speakers does not necessarily mean you have stereo.

Conventional narrow-band tuners cannot give the fine stereo quality obtained with Scott Wide-Band tuners. As the FCC pointed out, the approved multiplex stereo system ". . . like any multiplex transmission system, will increase energy transmission at the edges of the channel involved. *Accordingly for optimum stereophonic reception, the (tuner's) bandwidth . . . must be considerably greater than that of monophonic (tuners) . . .*"\*Scott tuners have *always* had the wider IF bandwidth needed.

Since stereo FM broadcasts are such an abundant source of high quality program material, many listeners will want to make off-the-air stereo tape recordings. In many instances, however, conventional multiplex circuitry causes interference with a tape recorder, resulting in whistles and beeps being recorded on the tape. Scott multiplex units incorporate the expensive filters needed to prevent this interference. Scott equipment can be used with *any* tape recorder.

New FM Stereo will bring you thrilling broadcasts of world famous symphony orchestras and opera companies . . . intimate close-ups of jazz in stereo . . . dramatic presentations with life-like movement. You will hear the wonderful *new* sound of FM multiplex stereo in your home . . . and using Scott equipment, you will be able to make flawless off-the-air stereo tape recordings.

\*See paragraph 36, FCC Report and Order, Docket No. 13506, 4/19/61.

## HERE'S WHAT MAKES SCOTT TUNERS SO OUTSTANDING

FM stereo multiplex reception makes more severe demands on a tuner than regular monophonic reception. You will undoubtedly enjoy your new Scott tuner much more if you have some understanding of the unique engineering that makes these tuners so outstanding. Below are some of the various factors that go into the design of a Scott tuner.

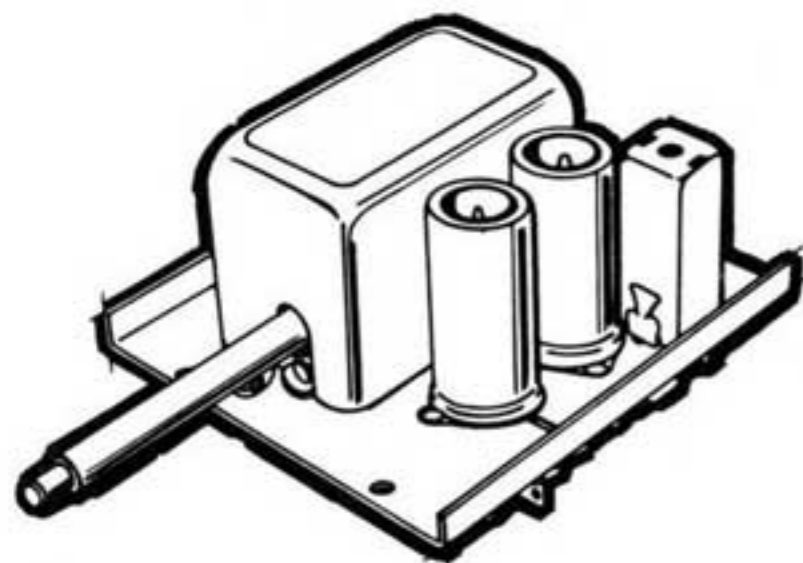

*Usable sensitivity* — indicates a tuner's ability to receive weak signals with very low hum, noise and distortion. Scott's high usable sensitivity is in part due to the silver- or copper-plated front end on Scott tuners. The high conductivity of these metals preserves the full quality of even the weakest signals without introducing the noise, hum or distortion of conventional tuners.

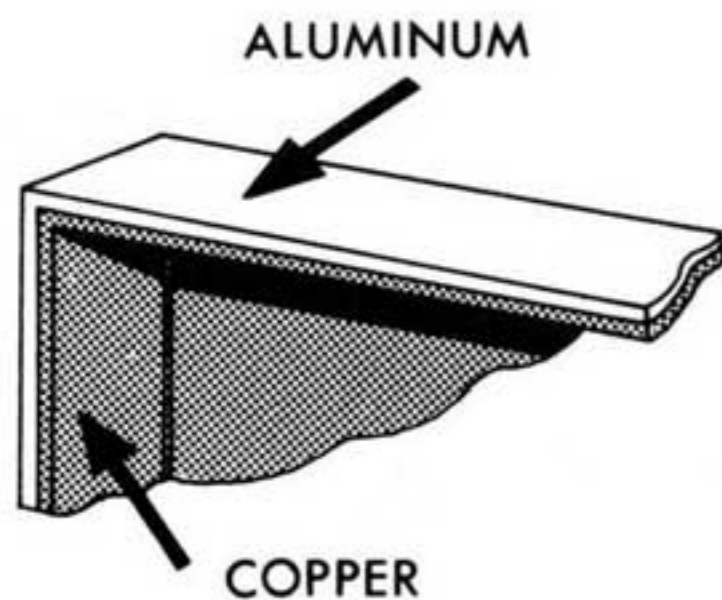

Instead of inexpensive steel chassis, Scott uses electrolytic aluminum with copper cladding in the critical IF and multiplex sections. Copper is a far better conductor than steel and eliminates the losses ordinarily associated with that metal. Aluminum, being non-magnetic, tends to reduce hum and noise, giving Scott tuners an exceptionally high signal-to-noise ratio.

*Selectivity* — is the ability to completely separate stations on nearby channels. Scott's Wide-Band IF's most closely approach the ideal by amplifying the desired signal and completely rejecting all nearby stations. Scott tuners separate stations that conventional narrow-band tuners would pass by.

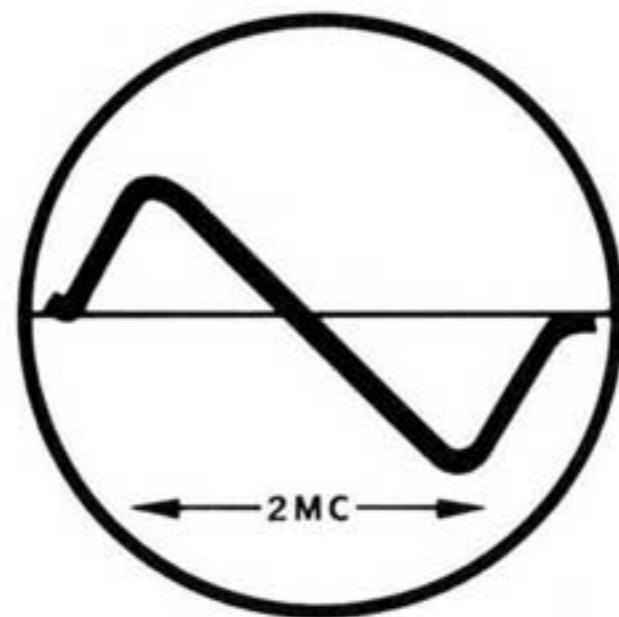

*Freedom from drift* — a tuner must stay on station without wandering (or drifting). Narrow-band tuners use undesirable automatic frequency control (AFC) to prevent drifting. AFC introduces considerable distortion and reduces bass response. AFC also reduces selectivity because its magnetlike attraction towards stronger stations pulls away from nearby weak ones. Scott tuners utilize Wide-Band design rather than AFC to eliminate drift, bringing you the full range broadcast without introducing distortion.

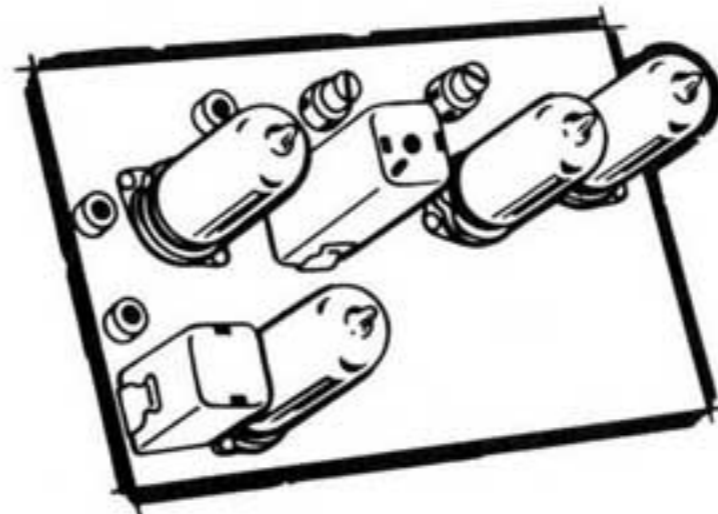

*Stereo separation with low distortion* — a must for good FM stereo reception. Conventional narrow-band tuners inherently cannot give as fine stereo quality as Wide-Band tuners. Scott-developed, Time Switching Multiplex circuitry provides full frequency response with extremely low distortion. Stereo separation far exceeds specifications established by the Federal Communications Commission.

## INSTALLING YOUR SCOTT TUNER



Your tuner can be placed on a table or bookshelf, in existing furniture like an end-table, buffet, or room divider, or in a specially designed equipment cabinet. A handsome wood accessory case is available from your dealer.

Wherever the tuner is placed, adequate provision should be made for ventilation. If this is not done, drift will occur in the FM section, and the life of the internal components will be appreciably shortened. By adequate ventilation we mean some space above and behind the unit where air may circulate freely, or, if it is installed in a cabinet, an open back.



If you install your tuner in the same cabinet with your amplifier, always place the tuner alongside the amplifier or underneath it — never above it, since the amplifier produces much more heat than the tuner. Hot air tends to rise and if the tuner is above the amplifier, the heat generated by the amplifier will cause drift in the tuner.

To help disperse heat rapidly, all Scott tuners employ aluminum in the construction of the chassis and panel. Aluminum is an excellent conductor of heat. Therefore, the panel may seem warm to the touch. As long as the unit is adequately ventilated, this is of no consequence.

## CONNECTING YOUR SCOTT TUNER TO A STEREO AMPLIFIER

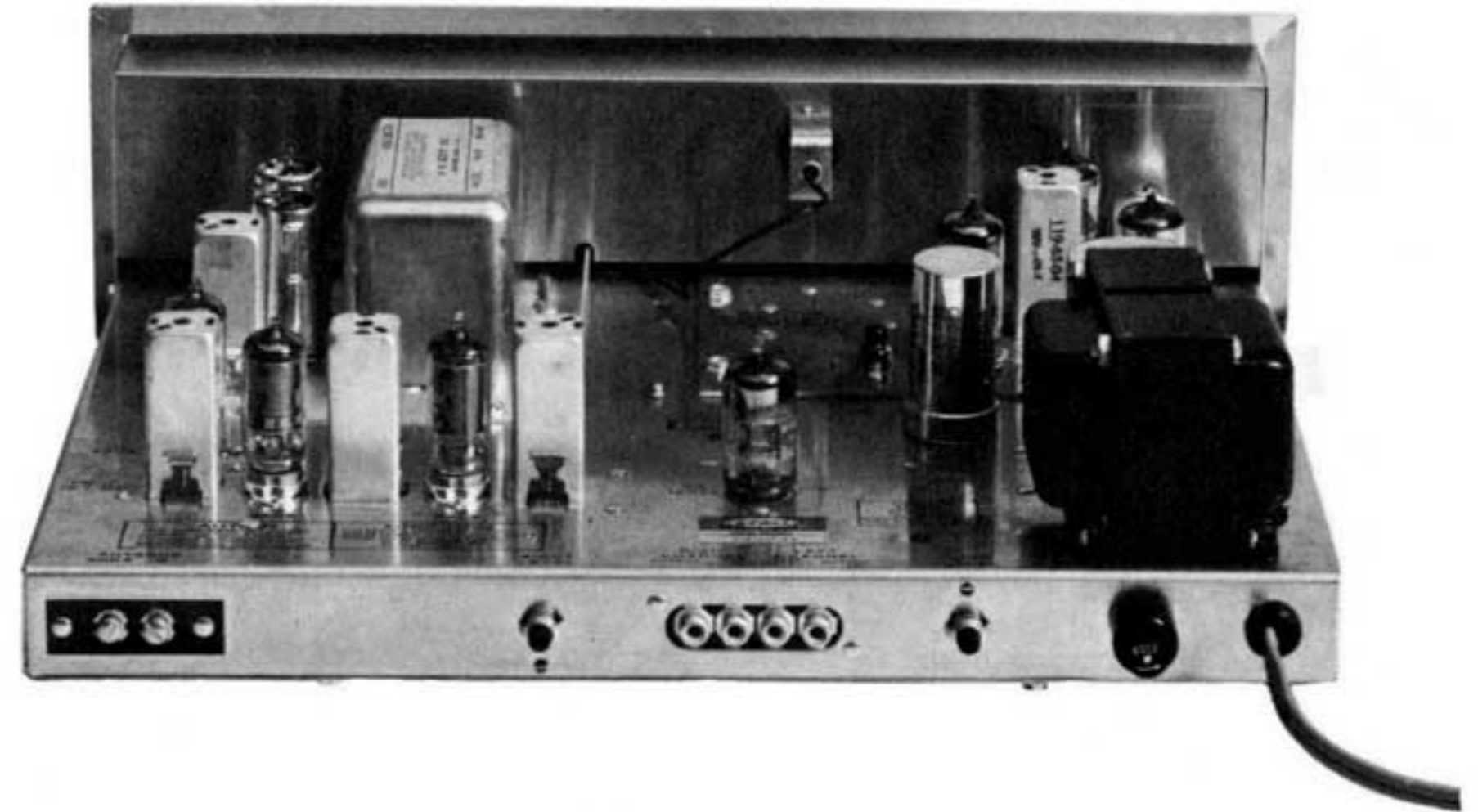

There are two sets of outputs for left channel and for right channel on the rear of your Scott tuner. Connect one of the two audio cables provided from the left channel ( audio or high ) output to the left tuner input on your stereo amplifier. Some amplifiers refer to the left input as Channel A. Connect the remaining audio cable to the right channel (audio or high) output to the right tuner input of the amplifier sometimes referred to as the Channel B input.

For most applications the three foot cables provided should be more than adequate. Longer cables can be obtained from your dealer if needed but it is not recommended that you use cable lengths in excess of ten feet.

## TO A TAPE RECORDER

FM multiplex stereo can be an excellent source of program material for home tape recording if interference effects can be eliminated. These interference effects occur when the subcarrier that provides the stereo information leaks into the audio output of the tuner and beats against the oscillator of the tape recorder. The resulting whistles and squeals would ruin any tape recording. All Scott tuners include a special filtering circuit which keeps the subcarrier from creeping into the output. This is another example of how advanced Scott engineering provides you with the maximum satisfaction from your equipment.

Most stereo amplifiers provide tape recorder outputs which can be connected directly to a recorder. If your amplifier does not have these outputs, or if it is inconvenient to use them, a set of outputs on your tuner can be used. An audio cable (10 feet or less) should be connected from the left channel tape (or low) output of the tuner to the left or Channel A tuner (sometimes called high level) input of the tape recorder. Follow the same procedure for the right channel.

*(350, LT-110, 310, and 4312 series) A stereo tape output is available on the front panel for use with portable tape machines. A special coaxial, dual channel shielded cable is needed for this output. This cable is usually provided with the tape recorder, or can be obtained from your dealer. This output can also be used to connect to a pair of high impedance stereo headphones.*

TAPE



## TO THE FM ANTENNA

An FM dipole antenna is supplied with the unit. In strong signal areas this should be more than adequate to pull in most of the FM stations available. Antenna connections are made to the terminal

strip marked "Antenna" located on the back panel. The dipole leads are connected to the screws marked "G" and "FM-300 ohms" respec-

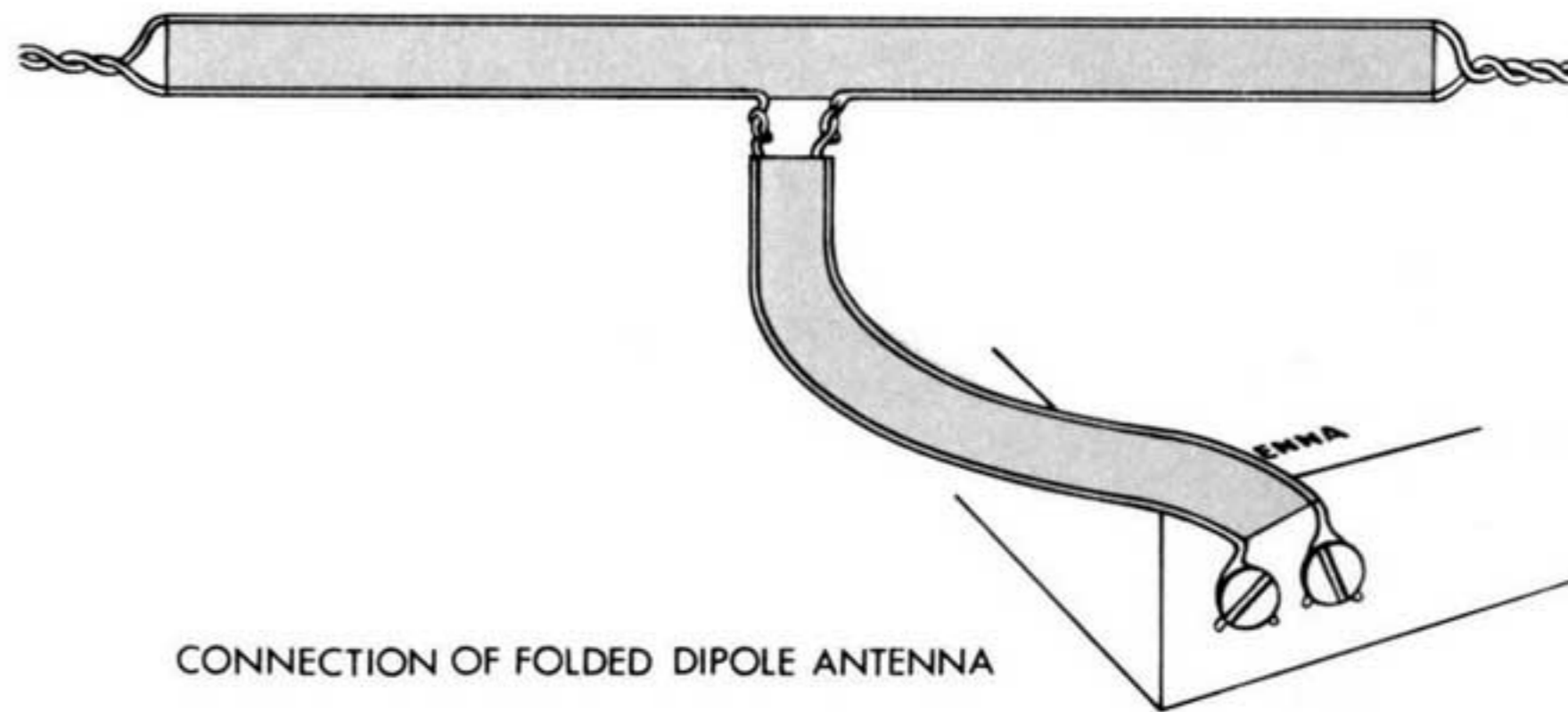

tively as shown above. The dipole should then be opened to a full "T" shape and positioned to give the strongest signal possible on the tuning indicator or meter on the front of the tuner. Tuners using an indicator tube show a strong signal when the dark strip in the center shrinks to its narrowest. Tuners with meters show a strong signal when the pointer is at its highest reading.

The dipole may have to be shifted slightly when trying to receive stations at different directions from the listener. A compromise position can usually be found that will work best for most of the stations desired. Generally, the higher the dipole can be placed, the stronger the signal. If you wish to place the dipole further away from the tuner than its present lead length permits, you can purchase from your dealer additional lengths of 300 ohm antenna wire to connect between the dipole and the tuner antenna terminals.

In fringe areas, or areas of high interference, an external directional antenna may be necessary. This is particularly true with multiplex stereo reception. Reflections from hills or nearby tall buildings can cause annoying distortion. There are many fine yagi FM antennas available which will provide strong signal and reduce interference, thus enhancing the range of the tuner. The remarkable sensitivity of your Scott tuner, when combined with a good antenna, will permit you to receive an astonishing number of distant FM stations, either monophonically or in stereo.

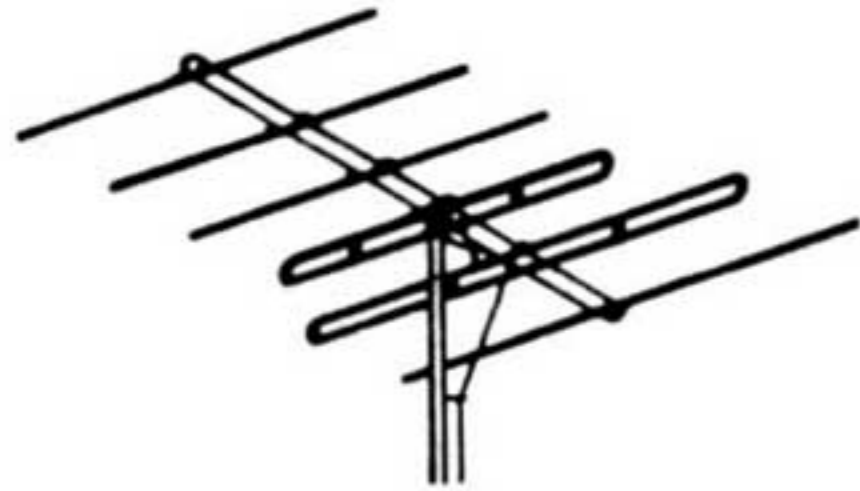

In areas of extremely high noise, such as a busy highway, the following system is suggested:

Mount a yagi antenna (either single or stacked) at some point as far removed from the source of the disturbance as possible. Connect a 300 ohm to 72 ohm transformer on the mast, and run 72 ohm shielded antenna lead-in wire to the tuner. The lead-in should not be more than 50 feet in length, if possible. Since the yagi antenna is extremely directional, it is important that it be positioned for the best reception of desired stations. In areas where stations are available in diverse directions, an antenna rotator is suggested.

### TO AN AM ANTENNA (333 SERIES)

On the top rear of your 333 you'll find an AM loop antenna. This will provide a fair amount of signal and will permit you to listen to most local AM stations clearly. However, your AM reception can be tremendously improved by doing any of the following:

1. Take the AC line cord and wrap it around the loop antenna several times before connecting to an AC outlet.
2. Take one of the speaker wires from your amplifier and wrap it around the loop antenna several times before re-connecting it to the amplifier.

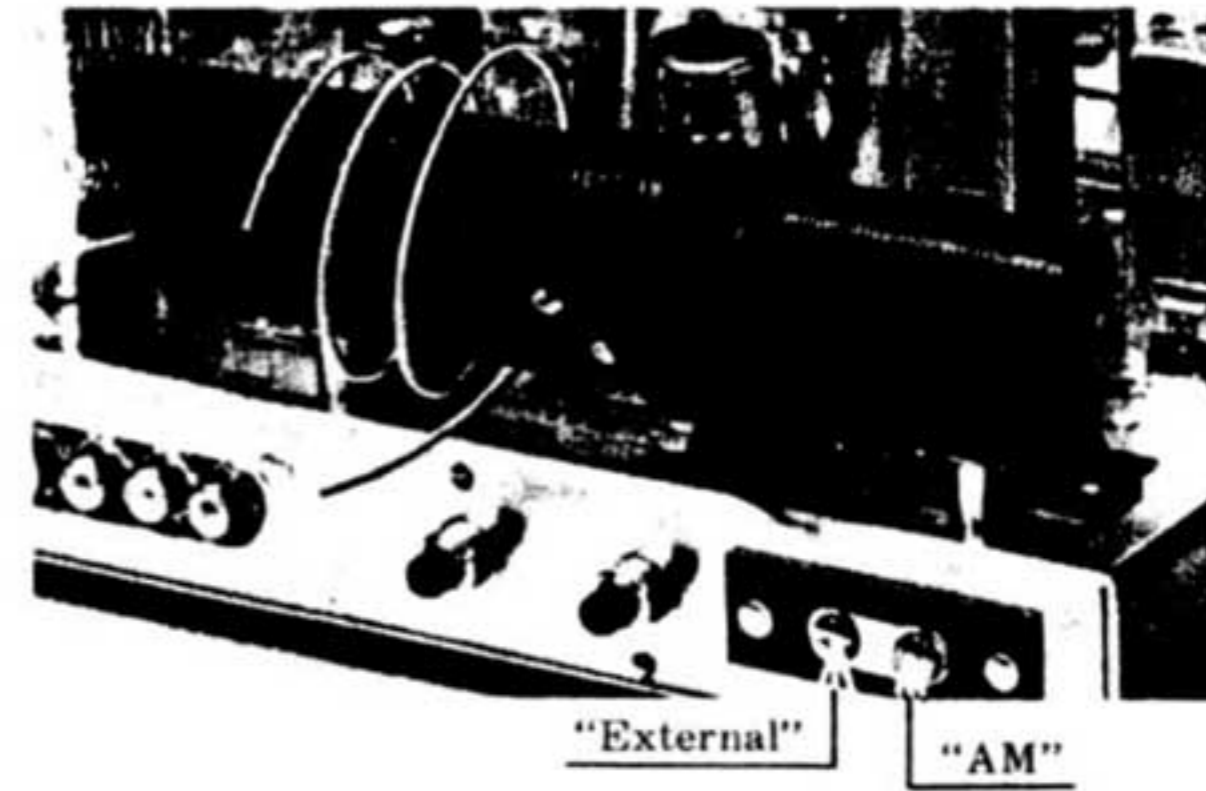

3. Take the FM antenna lead and wrap it around the loop antenna several times before re-connecting it to the FM terminals.
4. Unscrew the loop antenna from the chassis and move it away from the tuner. Try setting it in different positions and by looking at the meter find the one position that gives a stronger signal.
5. Disconnect the strap from the "AM" to the "External" screw terminal on the back. Connect a long single strand of lamp or bell wire to the External screw. Run the other end of this long piece of wire to some point outside the house, preferably on or near the roof. When trying any of these suggestions, use the tuning meter on the front panel to judge whatever improvement has been made in signal strength.

### TO AN AC OUTLET

The power cord should be plugged into any 105 to 125 volt, 50 to 60 cycle AC source. Do NOT use with a DC outlet. You can plug the power cord into a switched auxiliary AC outlet on your amplifier. When the amplifier is turned on it will turn the tuner on at the same time.



# USING YOUR NEW SCOTT TUNER

## TURNING YOUR TUNER ON

If you connect your AC line cord to an auxiliary switched outlet on your amplifier, the tuner can be left in the "On" position at all times. Turning the amplifier on or off will automatically turn the tuner on or off at the same time. When the tuner is on, you will see a light behind the dial.

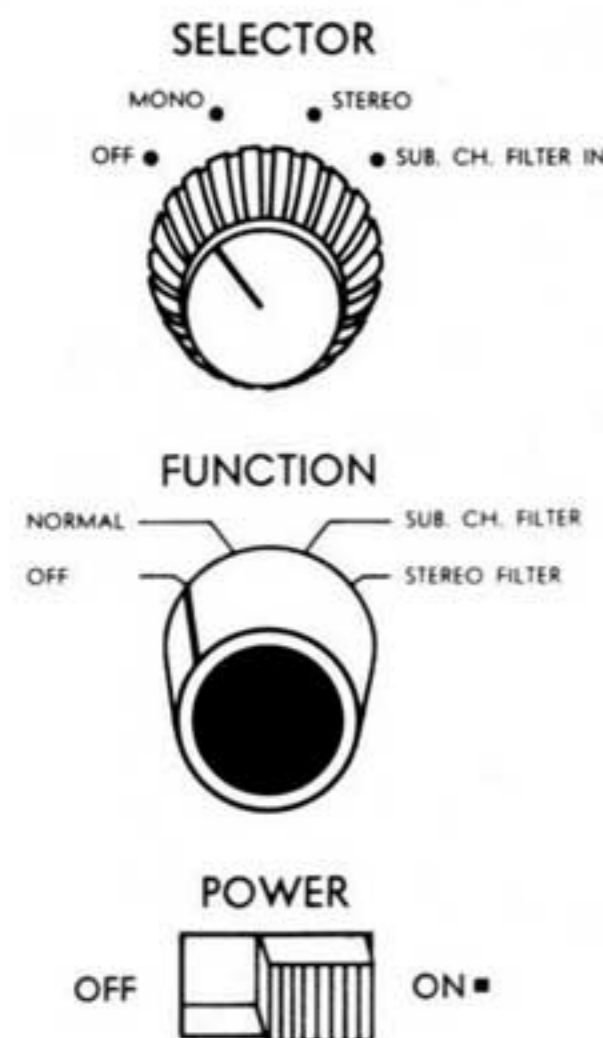

(Series 350, 370, LT-110, and LT-111) The off position is located on the **Selector Switch**. To turn the tuner on, simply rotate this switch to any desired position, such as FM mono or FM stereo.

(Series 310 and 4312) The off position is located on the **Function switch**. To turn the tuner on, simply rotate the switch to any desired position, such as Normal.

(Series 333) A separate **on-off switch** will be found.

## ADJUSTING THE LEVEL OF SOUND

Your tuner is designed to provide a steady level of sound whether you are listening to a strong, local FM station or a distant weak one. This results from the extraordinary AGC (Automatic Gain Control) designed into your tuner by Scott engineers. You will not have to jump back and forth to the volume control on your amplifier when turning from station to station.

The volume control on your amplifier will control the overall loudness whether you are using your tuner or your phonograph. However, amplifiers vary in the amount of gain they provide, so it is desirable to insure that the output from the tuner will not overload the amplifier.

(Series 370 and LT-111) A choice of two fixed output levels is provided. For most amplifiers (all Scott units) the high output should be used. The low output can be connected to a tape recorder. (Instructions will be found in the section on "Connecting Your Scott Tuner.") In some cases, you may want to use the low outputs for connecting to the amplifier. The criteria to follow is whether there is much change in volume when switching between phonograph and tuner. Either set of outputs may be used — the choice is up to you.

(Series 350, 310, 333, LT-110) Level controls will be found on the rear of the tuner allowing you to set the volume of sound so that it exactly matches your amplifier input.

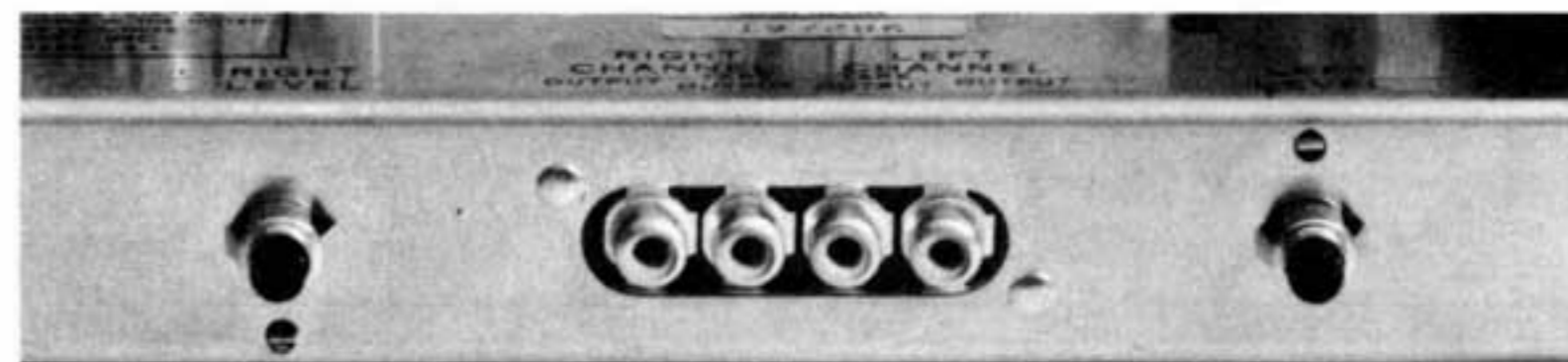

The level controls should be set once when you first install the tuner. Compare the volume of sound coming from a typical phonograph record played on your own record playing equipment with the volume of sound coming from a typical FM monophonic broadcast. Adjust the level controls so that the two are about the same intensity. By having individual controls you can adjust the volume from each channel so they are identical. Switch between Left Input (Channel A) and Right Input (Channel B) on your amplifier and adjust the level controls for equal sound level.

When using your stereo tuner for receiving stereo multiplex broadcasts, you may occasionally detect some minor variations in level between the two channels depending on the broadcasting station. This should only be corrected by use of the Stereo Balance control on your stereo amplifier as this will vary from station to station, and from record to record.

(333 Series) Three level controls will be found on the back of the 333. Those marked Right Level and Left Level refer to the FM channels and should be set according to the instructions above. After setting right and left level controls for FM, turn the **Selector** switch on the front of the 333 to AM position and adjust the AM Level Con-

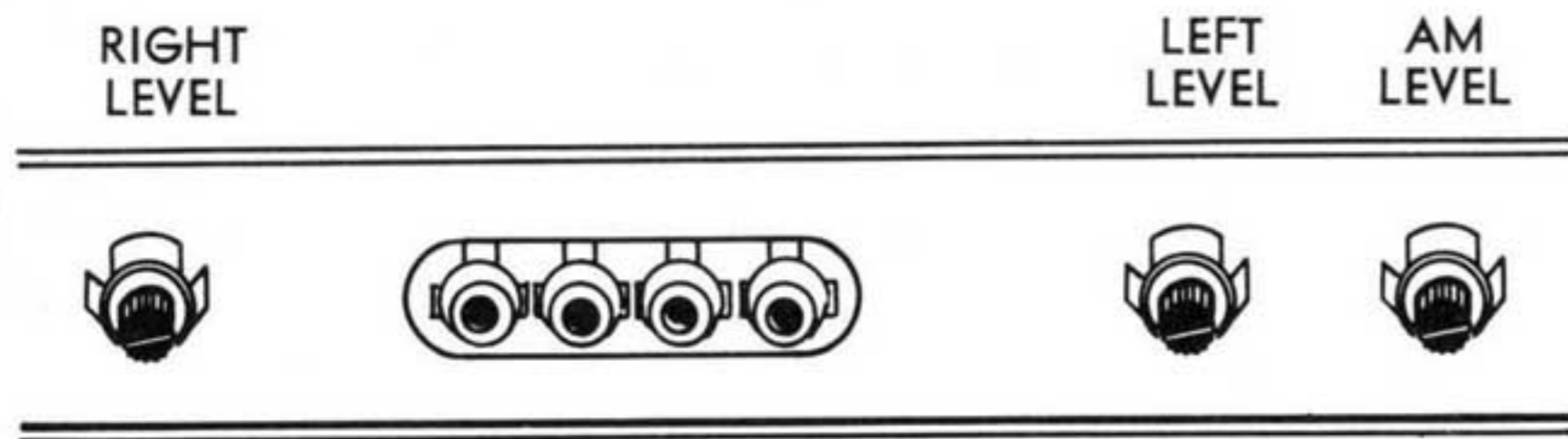

trol so that the volume on AM equals that on FM. By turning the front panel **Selector** switch back and forth from AM to FM position, you can equalize the level of the two. Remember after the Right Level and Left Level controls have been set on FM, only the AM Level Control is used to equalize the AM and FM levels.

(Series 4312) The level controls are on the front panel of the Model 4312. They should be set according to the instructions under Series 350, etc. However, you can readjust these controls to correct

for occasional variations in level between the two channels of a stereo broadcast. It would still be preferable to use the Stereo Balance control on your amplifier for this function, but by having the level controls on the front of the tuner, you do have the extra flexibility of using either.

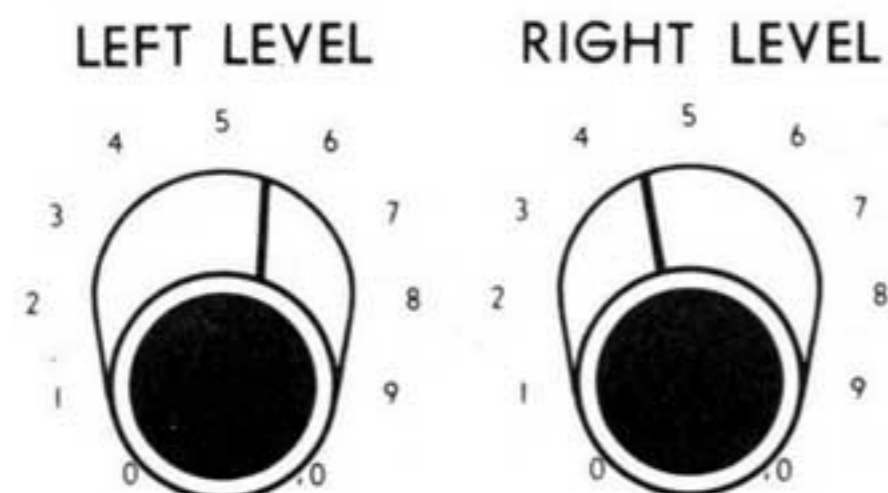

## TUNING IN AN FM STATION

FM is capable of providing wide frequency response, low distortion, and a significant amount of noise rejection. However, to take full advantage of these capabilities, it is essential that the station be tuned exactly. To insure precise tuning, Scott includes an accurate indicating device on all its tuners.

TUNING INDICATOR

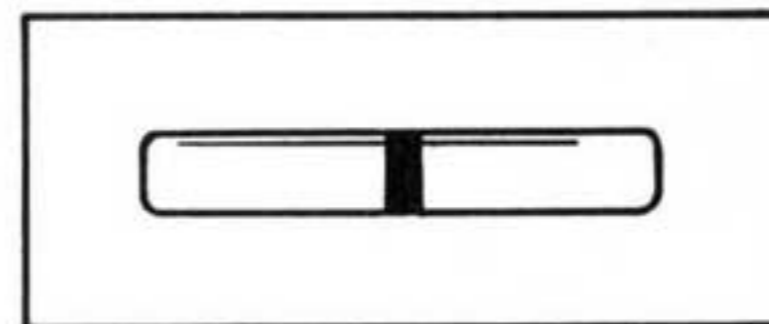

(370 and LT-111) The dark area in the center of the tuning indicator will be narrowest when the signal is strongest. With some local FM stations, this dark area may disappear altogether. Turn the tuning dial slowly and stop at the point of strongest signal.

(All other tuners) The precision tuning meter shows the relative strength of the incoming signal. Turn the tuning dial slowly and stop when the pointer has reached maximum. The meter reading will vary from station to station depending on the amount of signal present from the transmitter. The reading may even vary from day to day on the same station due to atmospheric conditions. Just tune to the point where the meter reads highest and you will be set for best reception.

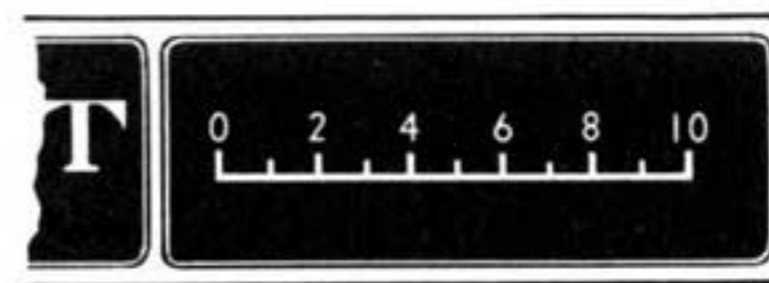

Occasionally you will note that the meter may swing violently back and forth. This indicates that an airplane is passing nearby. The swinging will stop once the plane has gone.

## USING THE LOGGING SCALE

Your tuning dial lists the various station frequencies in megacycles (i.e. 92, 96, 100, etc.) This is the standard method of locating a station — by its carrier frequency. However, the extreme sensitivity of your Scott tuner will permit you to receive many more

stations than you knew were possible. You may be able to listen to a station at 96.3 megacycles and at 96.7. Using the conventional part of your tuning dial, it will be difficult to tell which of these stations you have tuned.



To eliminate this problem, Scott has incorporated a logging scale on the dial as well. This divides the dial into an arbitrary series of numbers from 0 to 100. If you keep a record of your favorite FM stations by their logging numbers, you will not run into problems of confusing one with another. For example, the station at 96.3 megacycles, will log in at 41. The station at 96.7 will log in at 42. Simply tune the station by means of this logging scale and you will avoid confusion.

The logging scale is particularly valuable to those FM listeners who make use of the extreme sensitivity of their Scott tuners to locate as many distant FM stations as possible.

## LISTENING TO AN FM STEREO BROADCAST

The development of FM multiplex broadcasting is one of the great breakthroughs in home entertainment. Your new Scott stereo tuner will provide the maximum in listening pleasure when used to receive one of these remarkable broadcasts. First, you must locate a stereo program. This can be done by referring to your newspaper or to the FM station's program booklet. A much easier way is to use the convenient built-in stereo indicator found in your Scott tuner. **SONIC MONITOR\*** (*Series 333, 350, 370, LT-110, and LT-111*)

A unique Scott development, the Sonic Monitor, acts as an extremely accurate guide to the presence of an FM station broadcasting in multiplex stereo. Unlike some other stereo indicators, the Sonic Monitor does not provide false indications resulting from high frequency noises or sounds.

To use the Sonic Monitor (*Series 350, 333, and LT-110*) turn the **Selector switch** to the Stereo position. Turn the **Sonic Monitor**

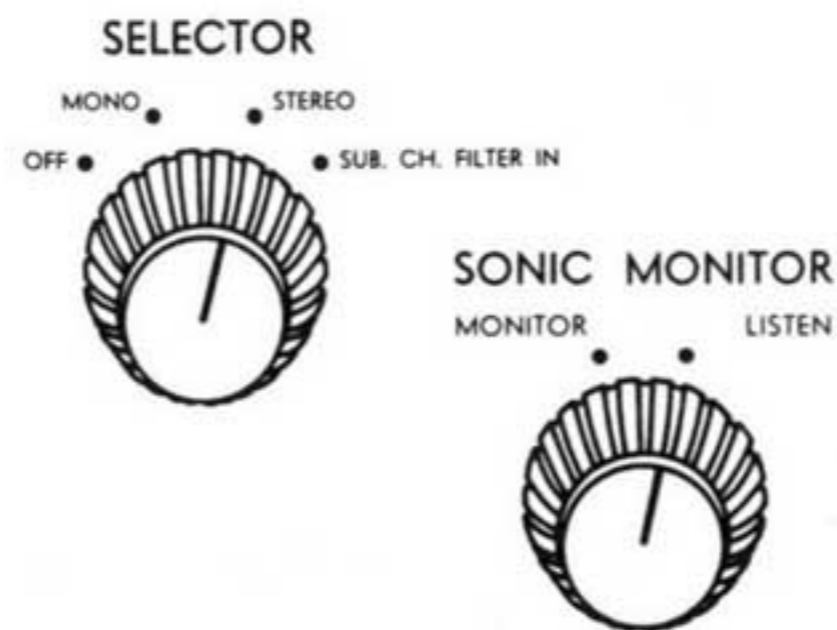

switch to the Monitor position. All stations will become virtually inaudible, and you will hear some hiss in the background. Turn the tuning dial slowly from one end to the other. The moment you hear a steady tone you know you have located a station transmitting in multiplex. Carefully adjust for the cleanest tone combined with high reading on the tuning meter. It is normal for some faint sound to be

heard above the steady tone. Turn the **Sonic Monitor** switch to the listen position. You will be perfectly tuned to a station broadcasting multiplex stereo.

(Series 370 and LT-111) To locate a stereo station, turn the **Selector switch** to the Monitor position. All stations will now become

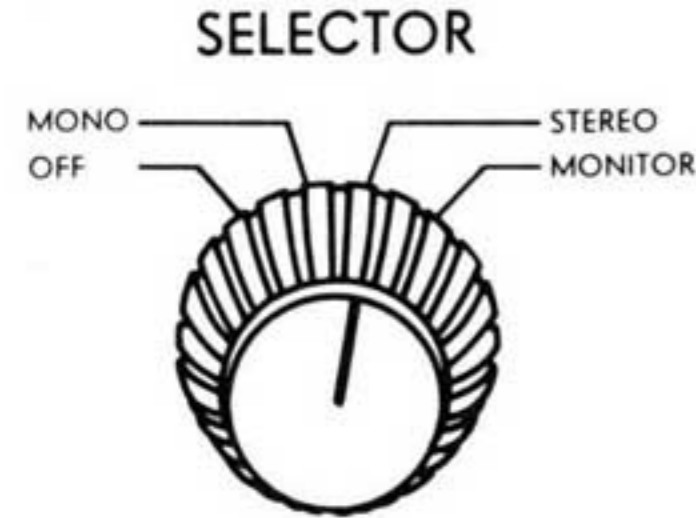

virtually inaudible and you will just hear some hiss in the background. Turn the dial slowly. The moment you hear a steady tone, you know you have located a station broadcasting in multiplex. It is normal for some faint sound to be heard above the steady tone. Carefully adjust for the cleanest tone combined with minimum dark area at the center of the tuning indicator tube.

Turn the **Selector switch** back to the stereo position, and enjoy a station perfectly tuned for multiplex.

#### SCOTT AUTO-SENSOR CIRCUIT (Series 310 and 4312)

The amazing auto-sensor actually switches your tuner to stereo automatically when you are tuned to a station broadcasting in multiplex. If the station returns to normal monophonic operation, the tuner will automatically switch back to monophonic reception. You never have to think about resetting the controls.

To listen to a stereo broadcast with the Auto-Sensor circuit, turn the **Selector Switch** to Automatic Stereo and set the **Stereo**

**Threshold control** to "0". Tune across the dial slowly. When you locate a stereo signal, a pilot light will flash on and the tuner will instantly switch to stereo operation. You will hear a clicking sound when this occurs.

If you are only interested in receiving stereo broadcasts, you can turn the **Selector switch** to the stereo position. In this position,



you will only hear a station if it is actually broadcasting multiplex stereo. If the station is transmitting monophonic programs, you will receive no signal from your tuner. On the other hand, if you turn your **Selector switch** to FM mono, you will receive all stations monophonically, whether they are broadcasting in stereo or not.

#### LISTENING TO FM MONOPHONIC BROADCASTS

If your built-in stereo indicator shows that a monophonic broadcast is in progress, simply turn the **Selector switch** to FM mono and enjoy superb FM monophonic reception from your Scott tuner. You do not have to vary any settings on your stereo amplifier. The tuner automatically provides a monophonic signal at both outputs. Therefore, even though the program is monophonic, you will still hear sounds from both speakers without further adjustments.

If a particular station happens to be noisy, much of the material provided in the Appendix will be useful here as well. In particular, use of the amplifier's scratch filter, or the tuner's **Stereo Noise Filter** should be examined.

(Model 310 and 4312) The auto-sensor circuitry will instantly switch the tuner to receive monophonic programs if no stereo multiplex signal is present. It is not necessary to set the **Selector switch** for FM mono. Simply leave the switch in the **Automatic Stereo** position, unless you want monophonic reception at all times.

#### LISTENING TO AM BROADCASTS (333 series)

Your tuner incorporates Scott's famous wide-range AM circuitry which is capable of providing AM reception virtually indistinguishable from FM. Although AM is not as interference-free

as FM, there is no reason for the limited frequency response common to most AM receivers. Scott has proven that a good strong AM station with quality programming can provide enjoyable listening. It is important to supply the tuner with an adequate signal. Re-read the section on "Connecting an AM antenna."

To listen to AM, rotate the **Selector Switch** to the AM position. Monophonic AM will be heard over both speakers automatically without readjusting your amplifier input setting. If you have a strong signal, set the **AM selectivity switch** to wide. In this position, you will get the best frequency response, but combined with a tendency to pick up noise if the signal is not strong enough. With a noisy signal or with a distant station subject to interference, slide the switch to Normal. There will be an improvement in noise rejection, with some restriction in frequency response. The quality will still be far above a common AM radio.

Your tuner was set at the factory to provide you either of the following modes of reception: FM monophonic, FM multiplex stereo, and AM monophonic. If your area does not presently have any multiplex stereo broadcasting, but does still have AM-FM stereo simulcasts, you can change the setting to receive this older method

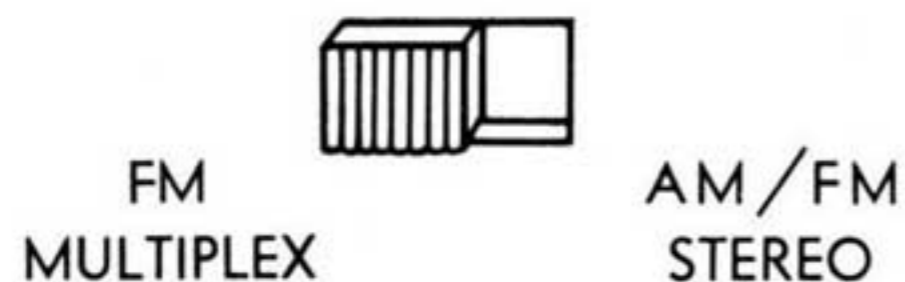

of broadcasting stereo. On top of the chassis is a slide switch. Move the switch from FM Multiplex to AM/FM stereo. You will not be able to receive multiplex when the switch is in this position, but you will still be able to receive FM and AM monophonic broadcasts.

## ELIMINATING INTERSTATION NOISES

(310 and 4312 series)

A characteristic of any FM tuner is the loud rushing or hissing sound audible between stations. Your tuner has Scott's exclusive Dynaural Squelch circuit to eliminate this annoying noise. Unlike conventional hush or muting devices that introduce severe amounts of distortion or cause a loud thump in the speakers, Scott uses a precision electronic relay which introduces none of these problems. By listening carefully to the tuner, a mechanical click will be heard as the relay turns off and on. This is perfectly normal.

## DYNAURAL SQUELCH

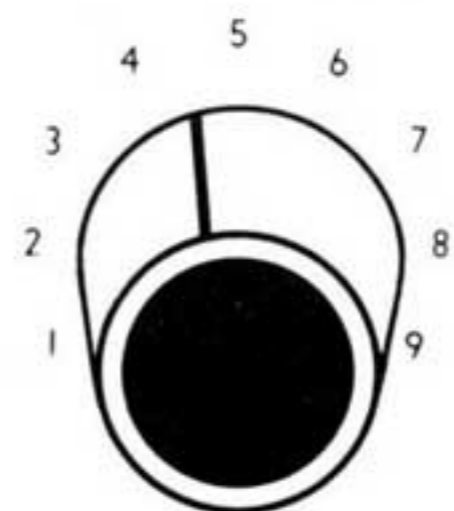

To set the control, first turn it to "0". Tune in between two stations so that the interstation noise is quite audible. Now turn the **squelch control** clockwise until the noise disappears. Turn the control just a little beyond this point and leave it there. As you tune across the dial, you will find that stations pop in and out from a background of complete silence. A pilot light on the *310 series* lights up when the squelch circuit is in operation.

The squelch circuit is actuated by the presence of noise. If you are looking for a particularly weak station that is subject to noise, you may find that the squelch circuit will cut this out. Therefore, if you are anxious to receive a weak station, you may want to turn the **squelch control** down to "0".

# APPENDIX

## LISTENING TO FM WHEN SOME INTERFERENCE IS PRESENT

A major advantage of FM is its ability to reject extraneous signals that would cause static or noise over AM. FM Multiplex stereo broadcasting is more susceptible to noise pickup than is regular FM monophonic transmission. Nevertheless, your highly sensitive Scott tuner will reduce potential problems to an absolute minimum.

No tuner will make a poor transmission sound like a good one, nor can it completely overcome the difficulties arising from an inadequate antenna. Therefore, if you hear noise, distortion, or static on a particular program, first make sure of the following:

1. The noise, distortion, or static may be on the record or tape being played by the FM station. The wide frequency response of your Scott tuner permits you to hear everything, both the good and the bad.

2. Check your antenna system. It may not be positioned properly for best reception. You may be picking up reflections from buildings or hills which lead to multipath distortion (called ghosts on TV). The cure is a better, more directional antenna. Re-read the section on antennas near the beginning of this book. If you desire more information on antennas, write to the Technical Services Department (see address on last page).

There are certain things you can do to alleviate reception difficulties. A suggested list of remedies follows.

*(LT-111 and 370 series)*

1. Use of the scratch filter, on your amplifier, if it has one, will often reduce audible noise without reducing stereo separation. However, some of the high frequencies will be lost.

2. If the problem persists on a stereo program, turn the **Selector Switch** to mono. While you will no longer hear the program in stereo, you will probably have a listenable broadcast during the period of interference.

*(350, LT-110, 330 series)*

1. If the interference is present on FM Stereo but not on FM

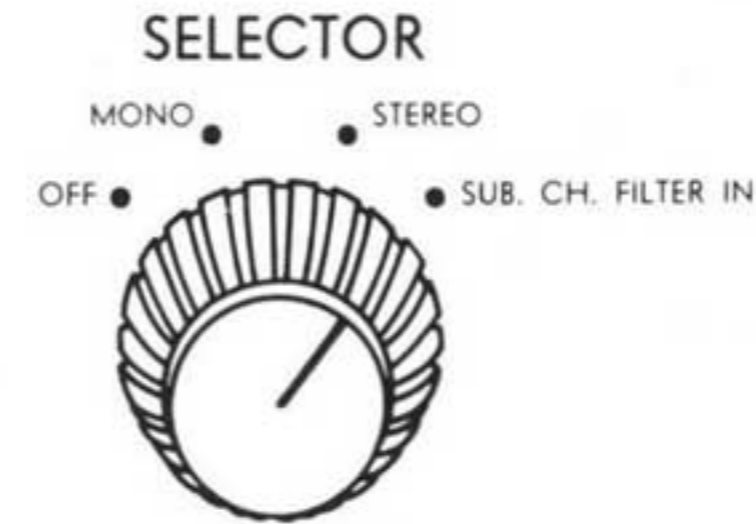

mono, turn the **Selector Switch** to *Stereo, subchannel filter in*. This filter does not affect the regular FM carrier (see introduction on How Multiplex Works). It only affects the subcarrier which tends to be more prone to noise pickup. The use of this switch position can drastically reduce noise without affecting the frequency response of the main carrier. However, as the sub-

carrier transmits the stereo information, use of the switch will cause a slight reduction in stereo separation.



2. If the noise on stereo persists, return the **Selector Switch** to Stereo, and slide the **Stereo Noise Filter** to the IN position. This filter will reduce the frequency response of the main carrier and therefore remove some of the high frequencies from the program material. However, the noise level is usually significantly reduced. This switch

has no effect on stereo separation. With 333 series the same result can be obtained by using the scratch filter on your amplifier.

### 3. AGC SWITCH

Scott engineers have discovered that a reduction in AGC (Automatic Gain Control) action will frequently improve the noise rejection of the tuner when listening to stereo broadcasts. If the above two suggestions do not help, slide the **AGC switch** from Normal to Par-

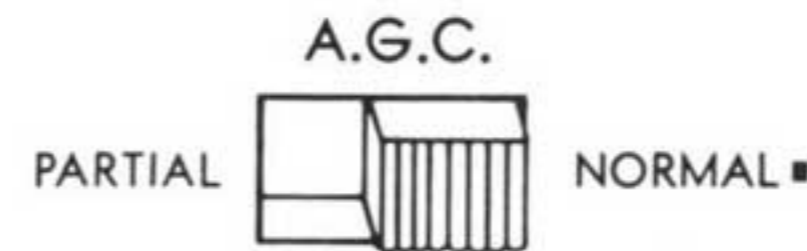

tial. If this improves the signal, leave it this way while listening to the stereo program. In this position, however, the meter does not give an accurate reading. Therefore, always return the **AGC switch** to normal when retuning or changing stations in order to get full benefit of the tuning meter.

4. If all else fails, turn the **Selector Switch** to FM mono. While you will no longer hear the program in stereo, you may at least receive a listenable signal during the period of the interference.

5. If you have interference on a regular FM monophonic program, you can use the Stereo Filter as outlined in "2" above.

(310 and 4312 series)

1. Read over sections (1) and (2) under *Series 350, LT-110, and 333* above. The suggestions apply here, too. In addition, the **AGC Switch** described in "3" above is on the 310 series. The only difference is that the various filters will be found on the **Function Switch**. Keep the **Selector Switch** in the Automatic Stereo or Stereo position while using either of the two filter positions.

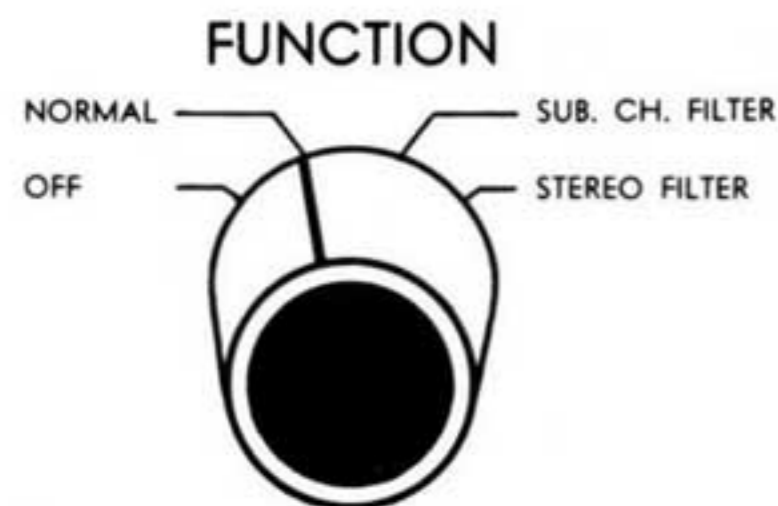

## 2. STEREO THRESHOLD CONTROL

The subcarrier is more prone to pick up noises than is the main carrier. For this reason, turning the **Selector switch** to FM mono will often eliminate the interference, because in this position the tuner does not use the subcarrier. Naturally, without the subcarrier there is no stereo effect. However, a quiet monophonic program is often better than a noisy stereo program.

The **Stereo Threshold Control** was designed to permit you to adjust for the minimum acceptable stereo signal. If the reception be-

## STEREO THRESHOLD



comes worse than this, the tuner automatically switches over to monophonic FM and thus reduces the noise level appreciably. For the home tape recordist, this feature can save a valuable recording from being ruined by interference. The tuner instantly returns to stereo once the disturbance has passed.

To use the stereo threshold feature, simply rotate the **Threshold control** to a higher number. By trial and error, you will locate a position that provides for a minimum satisfactory stereo signal. Any reduction of signal strength below this level will cause the tuner to switch over to mono. When this happens, the stereo signal light turns off. The use of the stereo threshold is strictly optional. Returning the control to "0" will remove it from the circuit.

**Note:** If the **Selector Switch** happens to be in the Stereo position rather than the Automatic Stereo position while you are using the **Threshold control**, the tuner will not switch to monophonic operation. Instead it will simply turn off all sound during the period of interference.

## A FINAL WORD —

Scott has always felt that our responsibility does not end when the sale is made. Therefore, H. H. Scott maintains a staff of experts whose sole duty is to assist you in any problems or questions you may have. Write to the address below, **GIVING THE MODEL AND SERIAL NUMBER** of your Scott instrument, (along with details on associated equipment) and carefully outline the information you need. You will receive a complete and detailed answer.

TECHNICAL SERVICES DEPT.  
H. H. SCOTT, INC.  
111 Powdermill Rd.  
Maynard, Mass.

# IT IS EASY TO CONNECT A SCOTT TUNER TO YOUR MUSIC SYSTEM

Follow simple diagram below to connect your tuner to the other components. For complete information on connections see page 4 in the instruction manual.

