

HiFi ENGINE®

For more Hi-Fi manuals and set-up information
please visit www.hifiengine.com

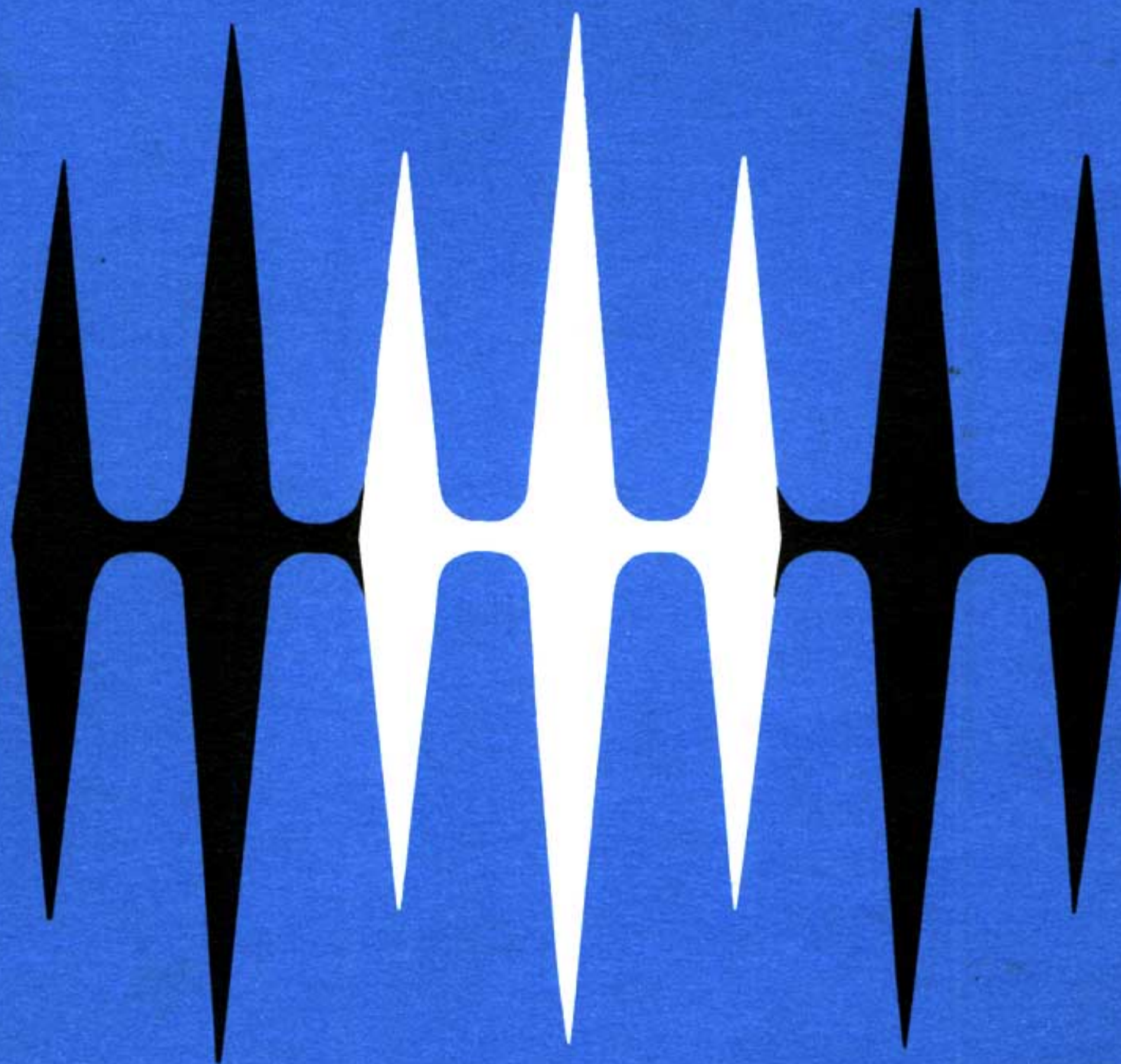

INSTRUCTION BOOK
H·H·SCOTT

LEADER IN AUDIO ENGINEERING AND DESIGN

Model LT-10

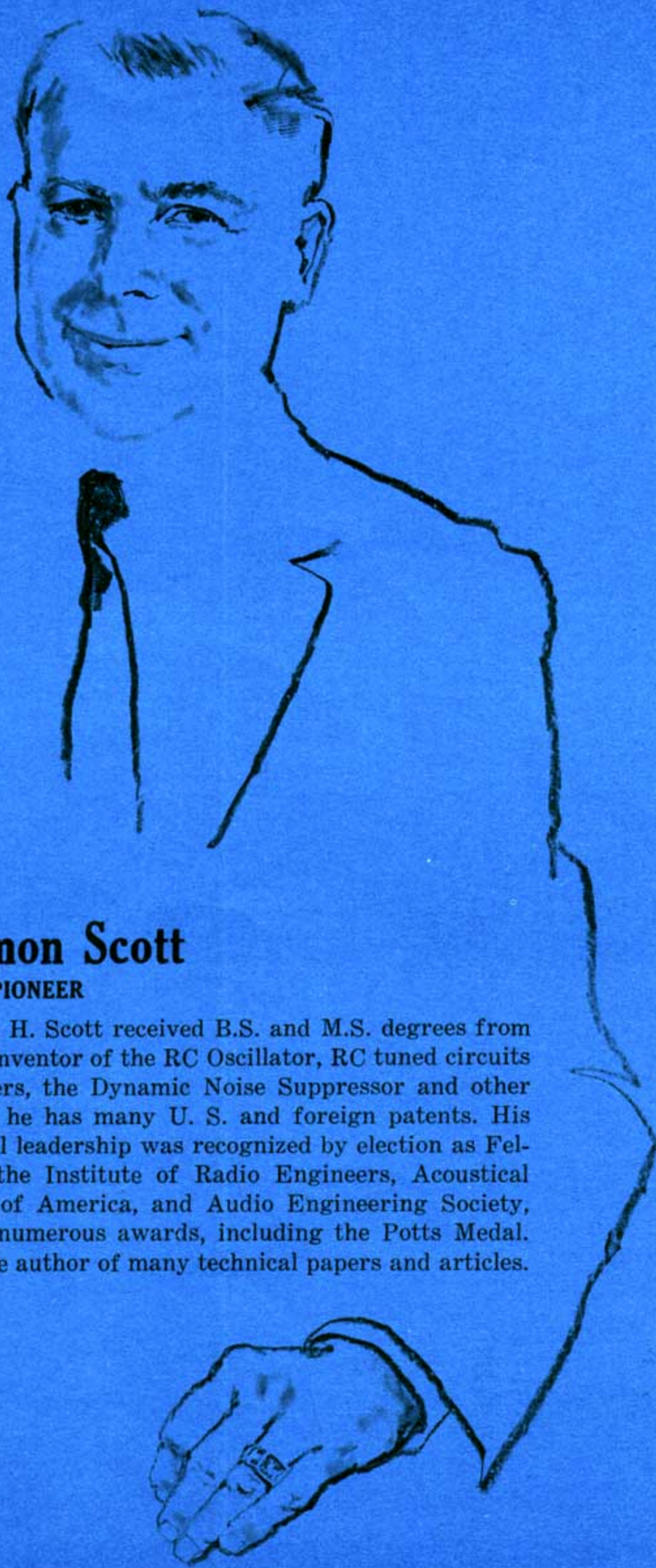

Hermon Scott

AUDIO PIONEER

Hermon H. Scott received B.S. and M.S. degrees from M.I.T. Inventor of the RC Oscillator, RC tuned circuits and filters, the Dynamic Noise Suppressor and other devices, he has many U. S. and foreign patents. His technical leadership was recognized by election as Fellow in the Institute of Radio Engineers, Acoustical Society of America, and Audio Engineering Society, and by numerous awards, including the Potts Medal. He is the author of many technical papers and articles.

Important Firsts . . .

BY H. H. SCOTT

First high fidelity AM-FM Stereo tuner using wide range AM design. First to successfully use wide-band circuitry in high-fidelity FM tuners. First to market The Stereo-Daptor, a stereo control unit that prevents obsolescence. First to provide center channel output on Stereo amplifiers for added realism in playback.

NOTES ON H. H. SCOTT TUNERS

What is the function of a tuner?

A tuner takes a radio signal from the air and converts it to an audio signal of sufficient strength to drive a power amplifier.

How is this done?

FRONT END	IF's	LIMITER	DETECTOR	AUDIO
--------------	------	---------	----------	-------

The station you want is selected in the front end and amplified by the RF amplifier. At this point, however, the signal is still not strong enough and must be further amplified. It is a principle of engineering that better performance will result if an amplifier is designed to operate over a very narrow band of radio frequencies and does not have to be tuned every time the frequency is changed. It is also easier to build an amplifier to handle frequencies lower than the

FM band. Because of these facts, the tuner takes the radio signal, no matter what station it is set to, and converts that signal to a new, lower frequency which remains the same regardless of the station you are hearing.

This process is called "conversion" and is handled in the tuner's converter. This new frequency is called the intermediate frequency, or "IF". The amplifiers that are tuned to that IF frequency are called IF amplifiers.

Here is how the signal for the radio station to which you are tuned is converted to the intermediate frequency:

It is a phenomenon of nature that when two frequencies are mixed together, resultant frequencies are created that are the difference and sum of the original frequencies. This principle is used in producing the IF frequency in the tuner. The IF frequency is the *difference* frequency. What actually happens is that the incoming radio signal is mixed with a signal generated in the tuner itself. The section of the tuner which produces its signal is called the "local oscillator", which is designed so that its frequency is always a fixed amount different than the incoming station. To do this, the frequency of the oscillator is changed every time the station is changed. The difference frequency produced in the mixer is in turn amplified in the IF amplifiers.

The next step in an FM tuner is called "limiting". Here, any undesired disturbances which affect the *amplitude* of the signal are removed in order to make the tuner a true FM tuner. In this way, the tuner will be sensitive only to changes in frequency, not amplitude. Obviously, an AM tuner does not contain a limiter.

After limiting, we are ready to remove the audio signal from its carrier. This is done in the detector. There are two basic types of detectors — Foster-Seeley and the ratio detector. The ratio detector has the added advantage of providing extra limiting, and it is this type of detector which is used in H. H. Scott's FM tuners.

The final stage of the FM tuner is one of equalization and amplification of the audio signal. Just as on a record, the transmitted signal is equalized differently from the original signal to improve the signal-to-noise ratio. Equalization is not necessary in AM tuners, as the signal is transmitted "flat".

One of the most important overall criteria of the tuner is its sensitivity, which is a measure of its ability to receive weak signals. Sensitivity can be expressed as the amount of signal required on the antenna terminals to give a certain ratio of audio output to background noise. The sensitivity of a typical H. H. Scott tuner could be stated as 0.75 microvolts for 20 db of quieting. This means that the background noise will be at

least 20 db below the audio signal.

This definition of sensitivity does not take into consideration the *quality* of the audio signal. Therefore, it is not a really accurate guide to the performance of a tuner. After all, what is the use of hearing a weak signal when it is so badly distorted that it is virtually unlistenable. The Institute of High Fidelity Manufacturers (IHFM) has devised a new method of measuring sensitivity which is known as "Usable Sensitivity." This indicates that the amount of signal required on the antenna terminals to obtain less than 3% of total hum, noise, and distortion (-30db). This is a much more severe criterion. Measurements made by this strict standard assure you that H. H. Scott tuners like the LT-10 are the most sensitive on the market.

Now that we have discussed the basic theory of tuner operation, we have to again look at the individual parts of the tuner to see what characteristics separate a good tuner from a bad one — in particular, we will discuss H. H. Scott design concepts for each stage of the tuner as compared with conventional tuners.

Front End

The "front end" consists of the RF amplifier, local oscillator, and the mixer. It is the part of the tuner that is actually tuned when you select a station. There are several important reasons why the H. H. Scott front ends give superior results:

1. Use of carefully selected low noise RF tubes.
2. Silver-plating on the front end and its components reduces circuit losses to a minimum and provides for maximum gain.
3. Prealignment of the front end subassembly which assures optimum uniformity in performance from each front end.

One of the basic problems inherent in front end design is drift. FM works on such high frequencies that even the slightest change of value of one of the electronic components can cause the tuner to go off station. The conventional way of keeping a tuner on station is to provide an auxiliary circuit called "Automatic Frequency Control" or AFC. AFC has certain inherent drawbacks:

1. The AFC circuit itself usually adds distortion to the received signal.
2. AFC attenuates low frequency response.
3. AFC tends to pull to strong stations — this is a disadvantage when you want to receive

a weak station next to a strong station. Of course, if you defeat the AFC, you will receive the weak station, but the tuner will drift without the AFC.

To overcome these limitations of AFC, the H. H. Scott engineering department designed a completely new front end that did not require AFC. Part of the new design was careful attention to the local oscillator so that as the tuner heated up, changes in the values of the electronic components could be compensated for by special temperature compensated components.

Another important characteristic of the front end is its ability to reduce interference known as cross-modulation. Cross-modulation simply means that you get a station at many different places on the dial in addition to the *one* place it should be. This is, of course, an undesirable characteristic because strong stations can appear at a point along the dial where a weaker station is desired. In the design of H. H. Scott tuners, this cross-modulation characteristic is practically eliminated by our special design.

A final point about our front ends is that they are carefully shielded on both top and bottom, in conformity with FCC specifications, in order that the local oscillator will not interfere with nearby television sets. This shielding also reduces the cross-modulation just discussed.

IF Stage

(In your LT-10, this includes T1, T2, T3, the two 6AU6's, and associated circuitry).

The ideal IF amplifier would:

1. Amplify *only* the station to which you are tuned and completely reject any other signals that might be passed by the tuner's front end to the IF amplifiers: This is referred to as "Selectivity." Even the best designed front end will sometimes pass stations other than the one the tuner is set to, so the IF's must be able to reject the undesired stations.
2. It will amplify, without distortion, soft *and* loud signals.
3. If the station is not exactly tuned in, the IF will still pass the desired station without distortion.

The selectivity of a tuner is defined as its ability to separate stations that are very close together. It is determined primarily by the shape of the IF amplifier characteristic. The more nearly perpendicular the IF curve sides, the more perfectly the tuner can separate adjacent signals. If the sides are at an angle rather than perpendicular, they will not separate nearby stations nearly as well. H. H. Scott has the most selective

IF characteristics in the entire tuner industry.

On H. H. Scott tuners, the desired signal, whether weak or strong, will be amplified with virtually no distortion and nearby stations are virtually totally discarded.

The amount of distortion in receiving a very weak signal is determined primarily by the shape of the top of the IF characteristic. The more rectangular the curve over the bandwidth of the station, the lower the distortion. It is often a trick of less expensive tuner manufacturers to give tremendous amplification to the signal in the IF amplifiers—the result, however, is very high distortion and an IF characteristic that is very pointed. In comparison with competing tuners which often have peaked characteristics, the H. H. Scott tuners have far flatter characteristics. The wider IF response of H. H. Scott tuners is part of its pioneering wide-band FM circuit design, with all its inherent advantages.

Because of the Wide-Band IF characteristics exclusive to H. H. Scott tuners you are able to align your LT-10 using a much simplified Ez-A-Lign® system. This would not work with conventional narrow band tuners.

The Limiter

(One half of your 6U8 and associated circuitry does the limiting in your LT-10)

The ideal limiter is able to remove amplitude or height changes in the signal very rapidly. The faster it can do this, the more likelihood that all such variations will be removed. H. H. Scott limiters are wide-band . . . 2 MC. The wider the band the faster the limiting action, and the H. H. Scott tuners have the widest band limiters in use today . . . therefore, the fastest. The result is superior rejection of any man-made or electrical interference in H. H. Scott tuners.

The Detector

(The detector stage of your LT-10 constitutes T4, the two diodes, and associated components.)

As stated before, the function of the detector is to remove the audio signal from the radio frequency carrier. The perfect detector would not disturb the audio signal in any way—it would be removed from the carrier intact. A measure of the ability of the tuner's detector to do this perfectly is the frequency bandwidth of the detector—the wider and more linear this bandwidth, the more nearly perfect job it can do. Normal detectors are made with frequency bandwidths ranging from 250 to 500 kilocycles. H. H. Scott utilizes a 2 megacycle detector, four times the width of most other tuners.

H. H. Scott uses ratio detectors which have the advantage of providing additional limiting. The wide-band detector is the heart of H. H. Scott's wide-band design. To a great extent, this wide-band detector accounts for the low-distortion performance of our tuners on weak signals, the freedom from drift, and the ease of tuning.

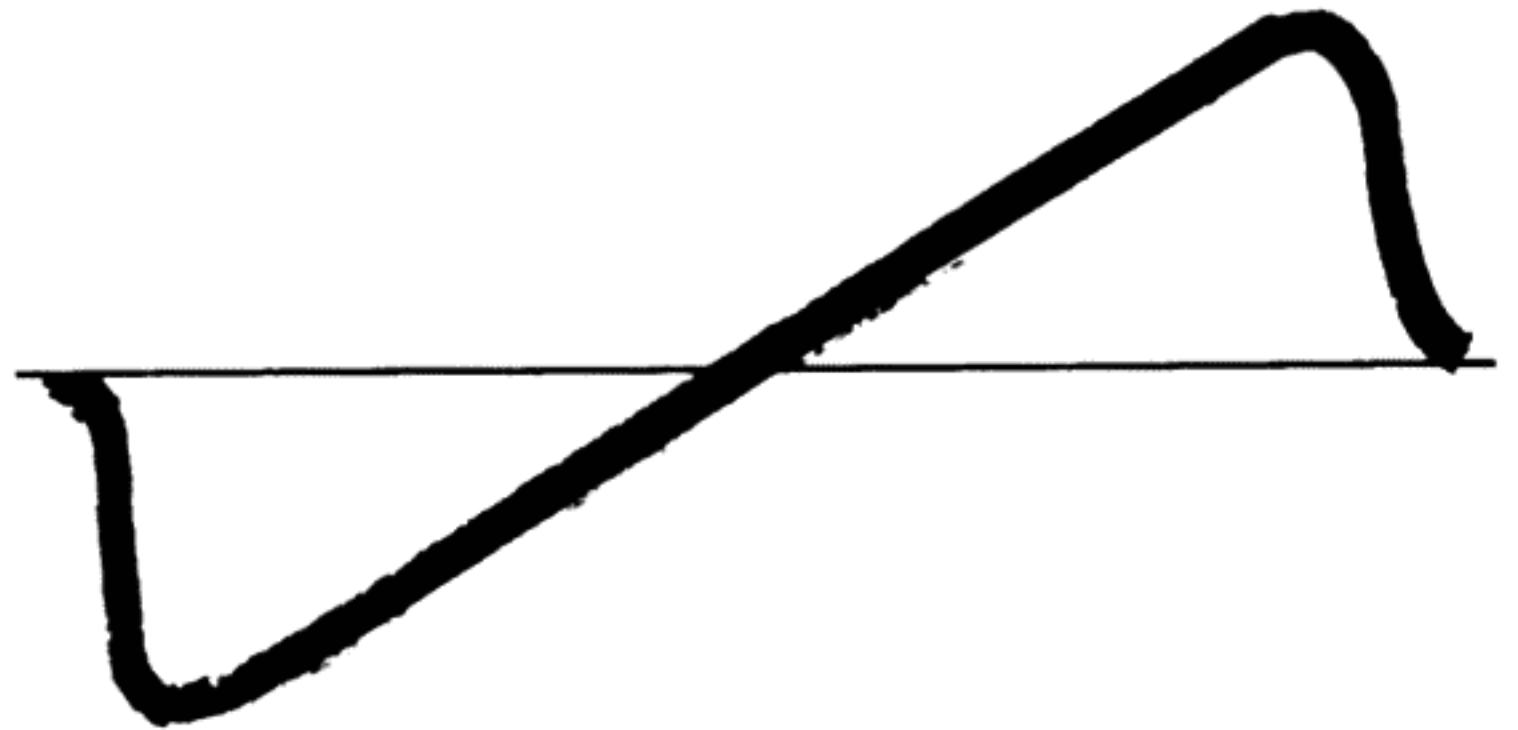

The H. H. Scott wide-band detector also gives the most favorable "capture ratio" in the industry today. It is characteristic of FM reception that if there are two signals on the same frequency, the weaker signal will be completely rejected as long as it is a specified amount weaker than the other signal. This "specified amount" is known as the "capture ratio". Since it is desirable to suppress as much interference as possible, the ideal tuner would have a capture ratio such that interference, only slightly weaker than the signal itself, would be completely rejected. The wide-band detector and wide IF's improve the capture ratio of H. H. Scott tuners.

After the audio signal has been removed from its carrier in the detector, it is equalized and amplified in the audio section of the FM tuner. At this point, the quality of the audio signal in H. H. Scott's tuners is far superior to that of ordinary narrow band tuners.

One of the reasons that H. H. Scott tuners offer high sensitivity with low distortion is that the circuit losses on H. H. Scott tuners are less. The front-end losses are less because the front end is silver-plated. You will notice that the rest of the chassis uses copper bonded to aluminum. Copper has the best conductivity of any metal except silver. Other tuners usually use cadmium plated steel and cadmium is a very poor conductor, also it is considerably less expensive. In dealing with RF frequencies, the conductivity of the chassis surface becomes all important. Poor conductors mean high circuit losses.

As you can see, H. H. Scott utilizes many exciting new principles in our design. We spare no expense in parts or construction. We feel that there can never be *any* compromise with quality. When you buy an H. H. Scott product we want you to know it is the finest.

LT-10 Parts List

1	LT-10 Chassis	
1	314-M6	
1	LT-10-M3	
1	RCV-500-P (P1)	
1	RCV-500K-P (P2)	
1	SPR-11 (P3)	
1	CEC-4x40/250 (C1)	
2	TRV-10.7 IF (T2-T3)	
1	TRV-10.7 D (T4)	
3	ACL-IF	
1	MS-S3 (M1)	
1	N-LT-10-1	
1	K-NP-8 (K1)	
1	KNP-16PT-O (K2)	
1	N-D-FM-2	
2	V-PL-47	
2	V-6AU6 (V1 & V2)	
1	V-6U8 (V3)	
1	V-6X4 (V4)	
1	XPL-U4-2	
1	XPL-U5	
1	A-GR-5	
1	A-GR-9	
1	H-N- $\frac{3}{8}$ x $\frac{1}{2}$	
2	H-N-440	
2	H-LW-4	
2	H-NC-440	
4	H-MS-440X $\frac{5}{8}$ F	
1	H-SS-832 x $\frac{3}{16}$	
6	H-SMS-6 x $\frac{1}{4}$ HW	
2	H-SP-5 x $\frac{5}{16}$	
1	E-LT-AT	
1	E-LT-AV	
1	E-LT-SD	
1	EV-9MA-1	
2	CC-.01 10KV	
2	CC-.001	
1	CC-.1	
1	CC-.02	
2	CC-.22	
1	CC-10NPO	
1	CC-12NPO	
8	CC-.0047	
1	CC-47NPO	
1	CM15-22	
1	CM15-330	
1	CM20-470	
2	CET-25/25	
1	CPM-.047	
1	CPM-.1	
2	DEN-294	
1	M-DV- $\frac{1}{2}$	
2	LRFC-1	
1	RC21-68 Ω	Blue/Grey/Black
3	RC21-220 Ω	Red/Red/Brown
1	RC21-270 Ω	Red/Purple/Brown
1	RC21-390 Ω	Orange/White/Brown
4	RC21-1K	Brown/Black/Red
1	RC21-3.9K	Orange/White/Red
2	RC21-10K	Brown/Black/Orange
1	RC21-33K	Orange/Orange/Orange
3	RC21-47K	Yellow/Purple/Orange
1	RC21-330K	Orange/Orange/Yellow
1	RC21-470K	Yellow/Purple/Yellow
1	RC21-2.2M	Red/Red/Green
1	RC21-4.7M	Yellow/Purple/Green
2	RC31-220 Ω	Red/Red/Brown
1	RC31-1K	Brown/Black/Red
2	RC31-22K	Red/Red/Orange
1	RW5-750	
1	LTP-9	
		PreMounted Front End, Linecord, Power Transformer
		Bottom Cover
		Control Shield
		Potentiometer
		Potentiometer
		Power Supply Switch
		Electrolytic
		IF Transformer
		Ratio Detector Transformer
		Brass IF & Detector Clips
		Meter
		Front Panel
		Knob
		Dial Knob
		Dial
		Pilot Light Bulb
		Tubes
		Tube
		Tube
		Meter Light Socket
		Dial Light Socket
		Rubber Grommet
		Rubber Grommet
		Switch Hex Nut
		Meter Nuts
		Meter Lock Washers
		Speed Clip
		Meter & Panel Machine Screws
		Dial Set Screw
		Bottom Cover
		Control Shield Sheet Metal Screw
		Meter Spacers
		Alignment Tool
		Solder Pack
		Screw Driver
		Tube Shield
		Ceramic Capacitor
		Ceramic Capacitor
		Ceramic Capacitor
		Ceramic Capacitor
		Ceramic Capacitor
		Ceramic Capacitor
		Ceramic Capacitor
		Ceramic Capacitor
		Ceramic Capacitor
		Ceramic Capacitor
		MICA Capacitor
		MICA Capacitor
		MICA Capacitor
		Tubular Electrolytic
		Tubular Condenser
		Tubular Condenser
		Diode
		Fuse
		Choke
		$\frac{1}{2}$ Watt Resistor
		$\frac{1}{2}$ Watt Resistor
		$\frac{1}{2}$ Watt Resistor
		$\frac{1}{2}$ Watt Resistor
		$\frac{1}{2}$ Watt Resistor
		$\frac{1}{2}$ Watt Resistor
		$\frac{1}{2}$ Watt Resistor
		$\frac{1}{2}$ Watt Resistor
		$\frac{1}{2}$ Watt Resistor
		$\frac{1}{2}$ Watt Resistor
		$\frac{1}{2}$ Watt Resistor
		1 Watt Resistor
		1 Watt Resistor
		1 Watt Resistor
		Wire Wound Resistor
		Owners Label

Instructions for the Model LT-10 wideband FM Tuner

The LT-10 is a wideband FM tuner employing the same silver-plated front end, the same wideband detector and IF transformers, the same quality features that have given H. H. Scott tuners a reputation as the best in the industry. The LT-10 is extremely sensitive, and its extended frequency response and distortion-free performance set it apart from conventional narrow band tuners. Conservatively designed, this tuner will bring you years of listening pleasure. For those interested in more complete information about tuners in general and H. H. Scott tuner design in particular, refer to the Notes on H. H. Scott Tuners.

IMPORTANT: *Every effort has been made to insure that this kit, when assembled, will perform perfectly. In order to achieve this result, you must read all of the instructions carefully and follow them precisely. Let us repeat . . . READ ALL INSTRUCTIONS CAREFULLY . . . FOLLOW THEM EXACTLY.*



1. Your Kit-pak cover will hold open when you insert special flap through slit in cover.

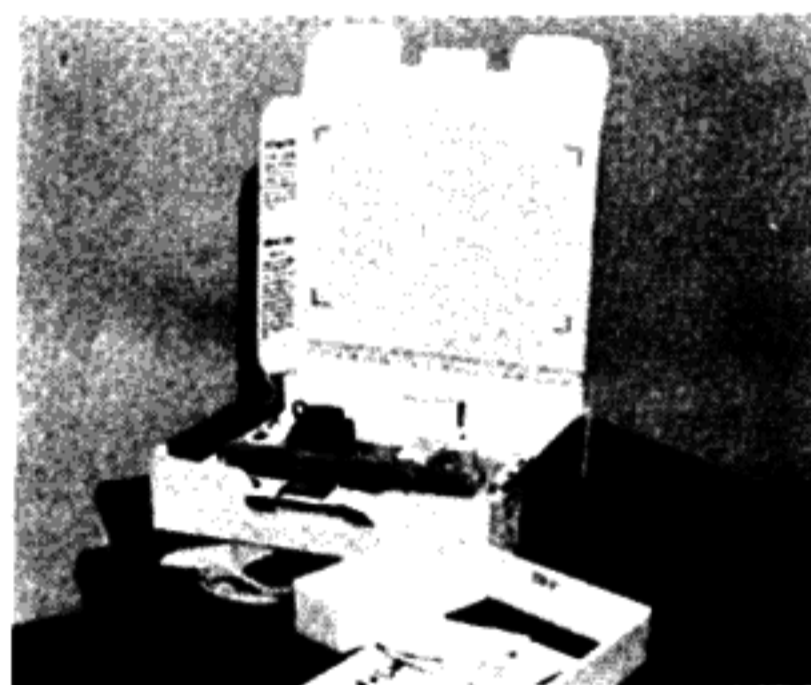

2. Remove the white insert and all loose parts.

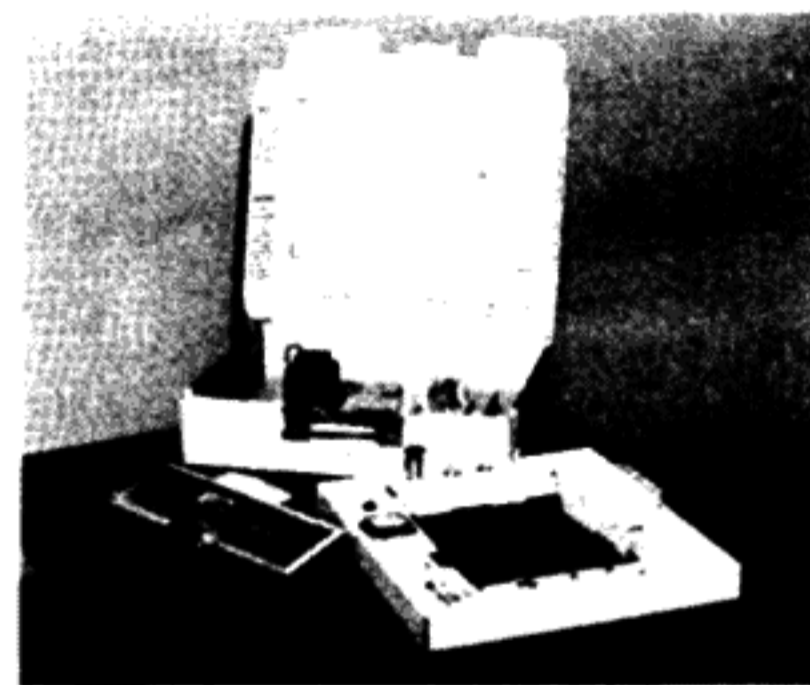

3. Remove the white platform.



4. Remove tuner chassis and all remaining parts. Turn over brown cardboard pad on bottom of box. Lift up flap in back. Reinsert in box.



5. Replace white platform (3) and white insert (2). Insert is replaced backwards.



6. Turn chassis over with long tuning shaft facing away from you and insert tuner in box so it is held securely.

Unpacking your Kit-Pak

Figure 1 demonstrates the step by step procedure in unpacking your kit, as well as the extremely simple procedures involved in setting it up as a convenient work bench. With the Kit-Pak you can work on any table in the house. When it is time to stop working for the evening, all you have to do is close the cover and turn off the soldering iron. Everything is put away in minutes.

You are now ready to begin the construction. During the mechanical assembly you will have to move the chassis a few times. However, once you commence the electrical assembly, the chassis will stay as shown in the sixth picture. After reading these introductory notes, place the instruction booklet into the groove between the cardboard flap and the box cover. In this way the instructions will be in front of you at all times for easy reference.

Mounted on the chassis is the famous H. H. Scott silver-plated front end. During the course of assembly you will be instructed to make certain connections to this preassembled unit. Outside of these specified do not make any adjustments, bend any coils, or turn any slugs on the front end. This unit has been completely tested and prealigned in our laboratory, and any uncalled for changes will adversely effect the performance of the tuner.

Check the parts

On page 4 of this manual is a descriptive list of the parts included. Before beginning the assembly it is recommended that you check all the parts with this list. It will insure that there are no missing parts, and will help you become familiar with the various items. If you should accidentally damage or misplace any parts, write to the LABORATORY KIT SERVICE DEPARTMENT at the factory immediately.

A four foot length of insulated wire has been supplied. It will be used for the alignment procedure at the end. Some of it can also be used to replace any missing wires or ones accidentally damaged, as you will not need the whole 4' for the alignment procedure. Simply cut off the length required (a convenient ruler is printed on the inside cover) and strip off $\frac{1}{4}$ " of insulation at each end.

Occasionally we may make minor substitution of parts. Such substitutions are carefully checked and the parts supplied will work as satisfactorily

as those specified in the manual. These changes will be obvious and are mentioned here only to prevent confusion in checking the parts list. For example, $.005 \mu\text{f}$ capacitors are used interchangeably with $.0047 \mu\text{f}$ capacitors.



Tools Required

An alignment tool and a small screwdriver are provided. In addition, you will need a pair of long nose pliers, a regular size screwdriver, a pair of wire cutters, and a soldering iron or gun. A 35 watt (or more) pencil type soldering iron is actually the easiest to use. The iron should be supplied with a small tip. If a soldering gun is used, it should also have a small tip, and should be used carefully because of the enormous heat it supplies.

Simplified soldering and wiring instructions

All the solder needed to assemble the unit is supplied. If for any reason additional solder is needed, make sure that you obtain 60/40 ROSIN CORE SOLDER. Under no circumstance should you use Acid Core solder. All guarantees are voided if Acid Core solder is used.

Here's how to solder joints correctly:

1. Before using the soldering iron or gun, the tip must be tinned for ease of use. First heat up the iron. Then when the tip is hot, wipe with a cloth till bright and shiny, and apply a generous amount of solder. Remove any excess. Repeat this process for all sides of the tip.
2. Make sure that all leads (wires) and terminals to be soldered are completely clean. Do not use fluxes or paste of any sort.
3. The leads should be mechanically secure before soldering. This does not mean wrapping leads around the contacts several times. It

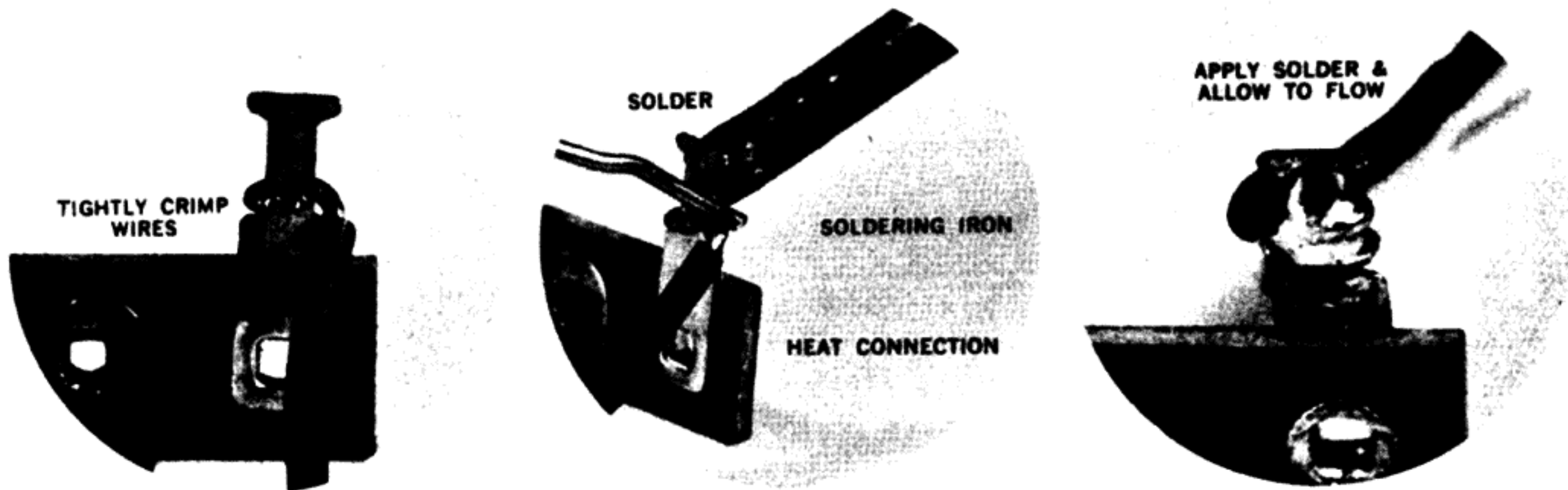

FIGURE 2

means a single turn around the contact which is then pinched tightly with the long nose pliers. If the wire is too large for bending, position the wire so that a good solder connection can still be made. (See Fig. 2).

4. Leads on resistors, capacitors, and similar components are generally much longer than they need to be to make the indicated connections. In these cases, the excess leads should be cut off before the part is added to the chassis. In general, the leads should be long enough to reach their termination allowing for a little left over to make a good mechanical joint. A very handy way of gauging the length of lead to trim off is to superimpose the capacitor or resistor right on the pictorial. The pictorials are all full scale, so by placing the component over its picture and allowing about $\frac{1}{4}$ " extra on each end for the mechanical joint, you can shorten the leads quickly and accurately.

Sometimes a lead will not seem quite long enough to reach the desired mounting point. In such a case, the terminal lug can be bent slightly to make the connection possible.

5. Place a flat side of the soldering iron tip against the joint to be soldered until it is heated sufficiently to melt the solder.
6. Place the solder against the heated terminal (with the soldering iron still in contact) and it will immediately flow over the joint. Use only enough solder to thoroughly wet the joint. Too much solder may cause short circuits. The soldering iron does not actually come into contact with the solder, only with the joint. It is the heated joint that melts the solder.
7. As soon as sufficient solder has flowed, remove the solder tube and then a second later, the iron. Use care not to move the leads until the joint has hardened (about 5 seconds). A good solder joint should appear to be bright and

shiny. Check the joint for rigidity. If it is not firm and tight, reheat the joint and permit the solder *already present* to flow again. Sometimes a little more solder will have to be added.

8. When soldering certain of the components, such as diodes and resistors, it is advisable to use no more heat than is necessary. Excessive heat can damage these components.

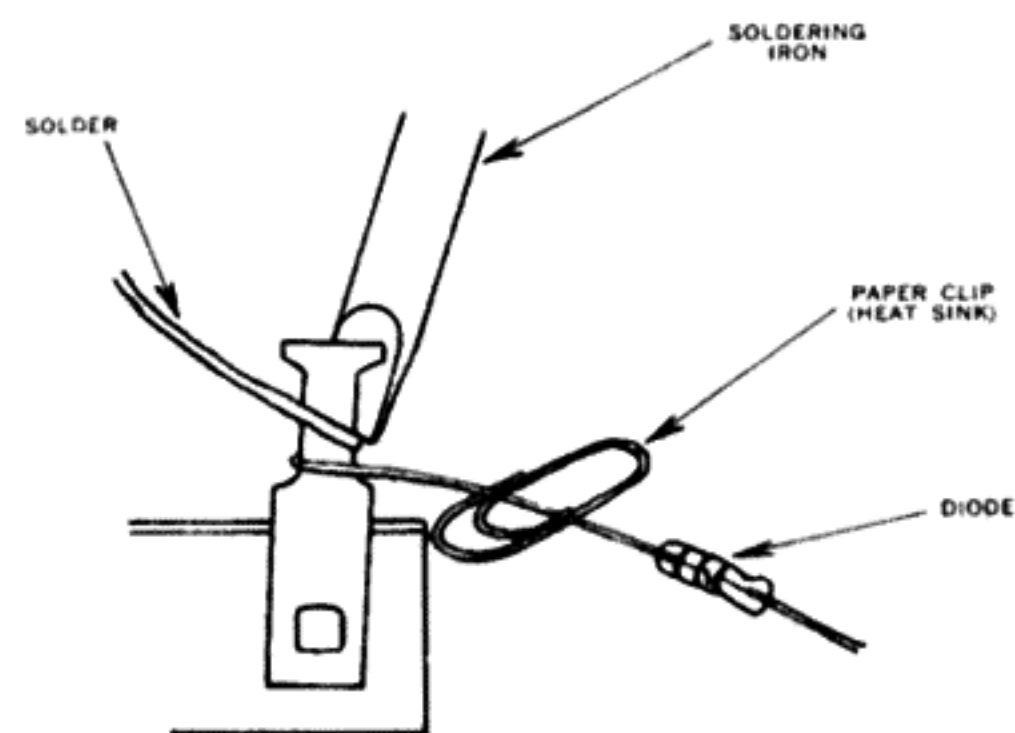

FIGURE 2-A

9. Keep the soldering iron clean and bright by occasionally wiping with a rag. The iron does not have to be cooled for this purpose.

If you have never done any soldering before, it would be an excellent idea to practice on scraps of wires before beginning.

Basic electrical assembly procedure

Every terminal, tube, transformer, etc. has a code number (i.e. T1, V2, and so forth). On Fig. A-1 there is a view of the top of the chassis with all the mechanical parts assembled and the code numbers clearly indicated. Become familiar with the location of all parts and of their code numbers.

On Chart A-2 is a view of the underside which should also be studied as almost all the wiring is done here.

Every pin on each tube socket has a number. These numbers can be noted by inspecting the base of the tube sockets carefully. The IF transformer and detector cans also have numbers on the base although they are not quite as readable. In any case if you look at the individual pictorial diagrams you will have no difficulty identifying the proper pin.

A series of Part-Charts are provided with all the necessary resistors, capacitors, and pre-cut, pretinned wires mounted. Each chart applies to a particular page of the electrical assembly instructions. For example — B-2 describes a series of connections involving different leads (wires). Part-Chart B-2 has these exact wires, mounted in the order in which they will be needed. The first step (B-2-1) calls for connecting a 6¼" red wire from pin 5, C-1 to pin 1, S-5. The top wire on the Part-Chart is B-2-1, a 6¼" red wire. The pictorial on the top of the page B-2, shows the location of pin 5 of C-1, and of pin 1 of S-5. The wire is then connected as shown and the step is checked off as being completed. **IT IS IMPORTANT TO POSITION THE WIRES OR COMPONENTS IN THE SAME POSITION AS SHOWN IN THE PICTORIAL.**

If the symbol — (S-) appears in the instructions after any connection, it means that the particular connection with all other wires on the same pin, should be soldered. After the "S" will appear a number. This number indicates exactly how many leads or wires are supposed to be connected to the terminal or pin in question. For example: connect an orange wire to pin 2, V6 (S-3). The soldering number (S-3) will always be printed in red, so it can be found quickly. It indicates that there should be 3 wires or leads (including the orange one) connected to pin 2, V6, and that all three of them are to be soldered. This provides an additional check for wiring errors.

Do not solder any connection that is not marked with an (S-). Other connections are still to be made to this pin before it can be soldered. Frequently one end of a lead or component will be soldered while the other end will not (for the moment). The (S-) will only appear after the description of the end that is to be soldered. After completing the soldering, cross out the (S-) symbol with your pencil indicating that it has been done. This is in addition to checking off each step. In this way you can glance over the assembly instructions and spot any (S-) that has not been crossed out, indicating that you may have overlooked a joint to be soldered.

The instructions which follow have been arranged in a logical order to insure perfect results. Follow them exactly, checking off each step as completed.

For easy reference keep this instruction manual on the inside of the top cover of your KIT-PAK as shown.

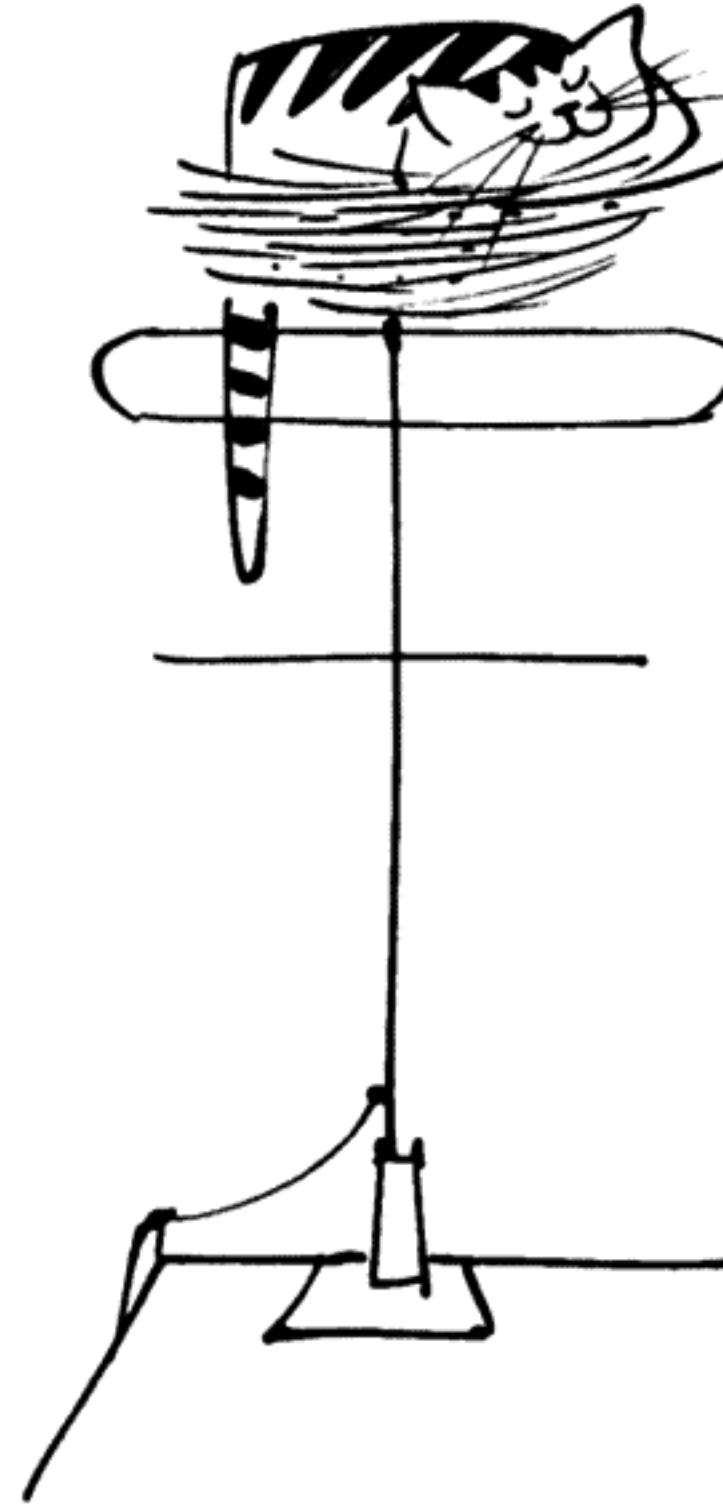

**Do not proceed
unless you have
read all the
instructions
given above.**

Mechanical Assembly

(Read each step completely before performing the operation specified. Check off each step as you complete it.)



A-1-1.

Position the chassis in front of you as shown on Chart A-1. Locate the small hole identified as P1 (Hum Adj.). Take the small potentiometer P1 (RCV 500P) and insert it into the hole from the bottom of the chassis. (See Figure 3.) The potentiometers (pots) come mounted inside the box right next to the tuner chassis. To doublecheck that you have the right pot, read the type number (such as RCV 500P) etched in small letters on the side of the pot. To obtain the proper placement, line up the locating lug on the side of the pot with the small hole next to P1. Push the pot up into the hole with your thumbs, applying sufficient pressure for the prongs near the top of the pot to spring open and firmly lock the pot in place.

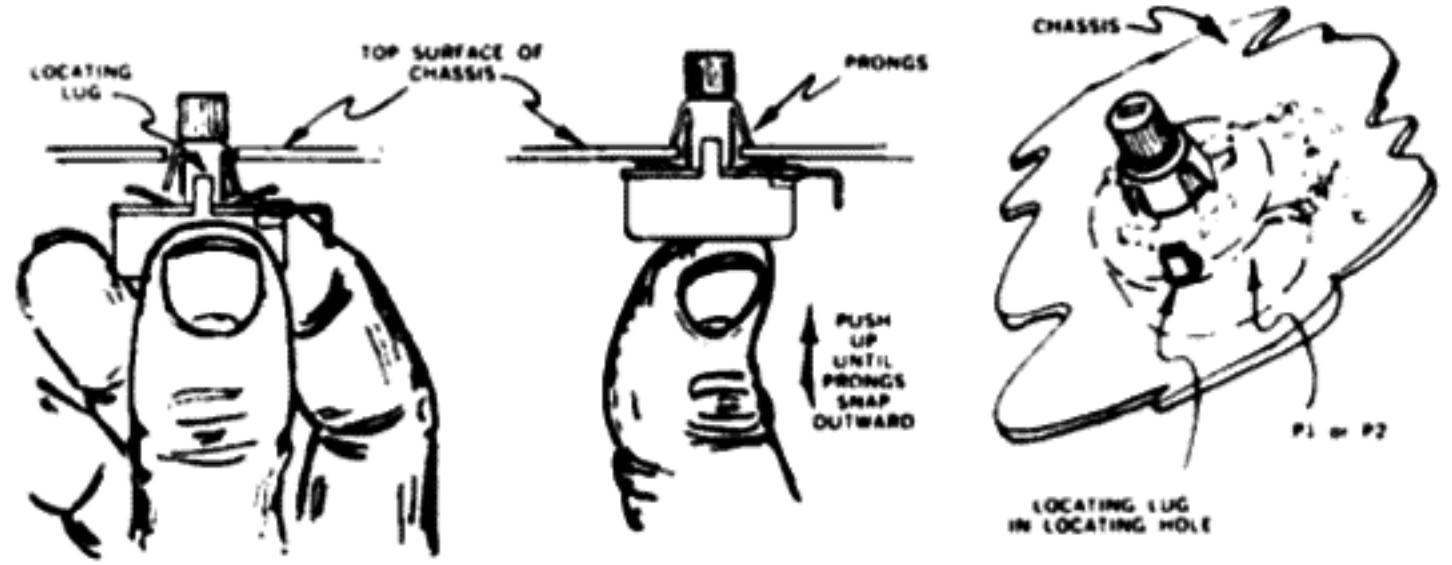

FIGURE 3.



A-1-2.

Install P2 (RCV 500 K-P) in the hole P2 (Level) by the same method described above.



A-1-3.

Install P3 (SPR-11) in the hole marked P3. The shaft goes outside the chassis. Use the lug on the side of the pot to position it correctly. (See Figure 4.) However, with this pot, a hex nut is threaded on to keep it in place. This should be put on finger-tight as it will have to be removed later.

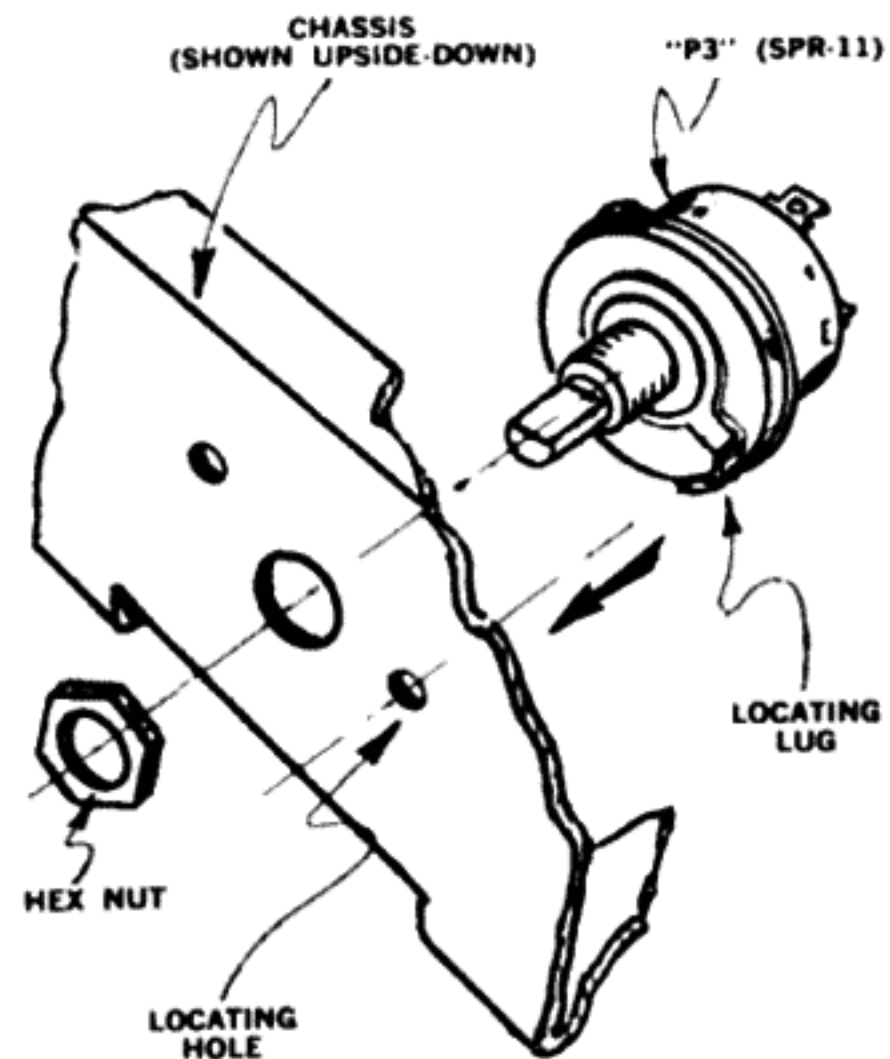
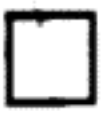

FIGURE 4.



A-1-4.

There are three transformer cans that you must mount to the chassis. These are T2, T3, and T4. T2 and T3 are identical and are identified by the number TRV-10.7IF found on the side of the can. T4 is marked TRV-10.7D. Take T4 and insert it into the slots marked T4 on the top of the chassis. (See Figure 5.) Position it so that the green dot on the base of the can is as shown in Chart A-2. Hold this in place with one hand. Working under the chassis with the other hand slip the special brass clip that will hold the can in place into the remaining two slots. Push one side of the brass clip hard, either with your finger or with the small screwdriver supplied, until it

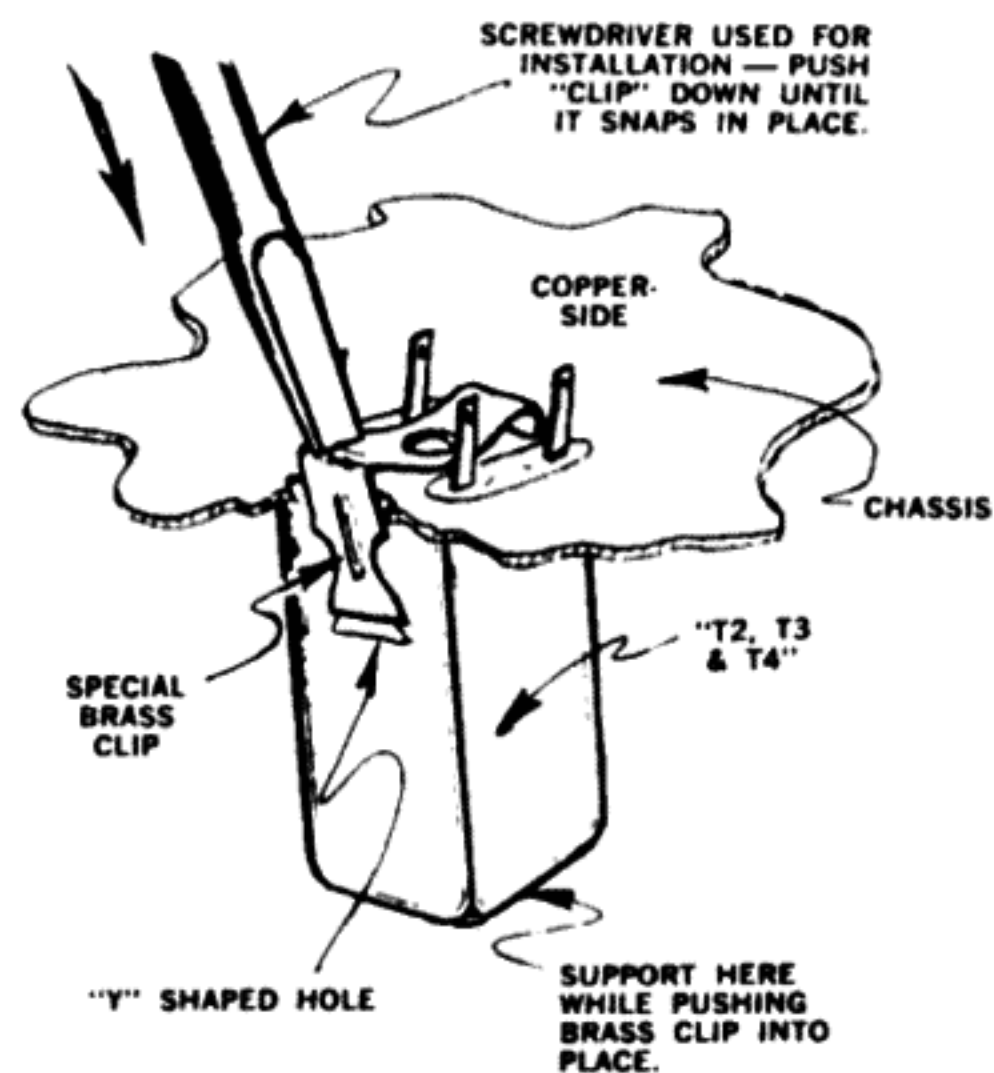

FIGURE 5.

snaps into the "Y" shaped hole on the side of the can. Then repeat with the other side of the brass clip. When completed the can should be firmly in place. Compare the appearance with that of T1 which is on the preassembled front end. *Be careful during this operation not to damage the pins on the bottom of the can.* Incidentally, T4 has one short pin as well as long pins. The other transformers have long pins only.

A-1-5. Repeat for T3, using either one of the TRV-10.7IF cans.

A-1-6. Repeat for T2, using the remaining TRV-10.7IF.

A-1-7. Mount the meter (M1) as shown in Figure 6. Use 2 tubular brass spacers, 2 flat-head machine screws, 2 lockwashers, and 2 nuts. After mounting the meter, remove the strips of tape from the back of the meter.

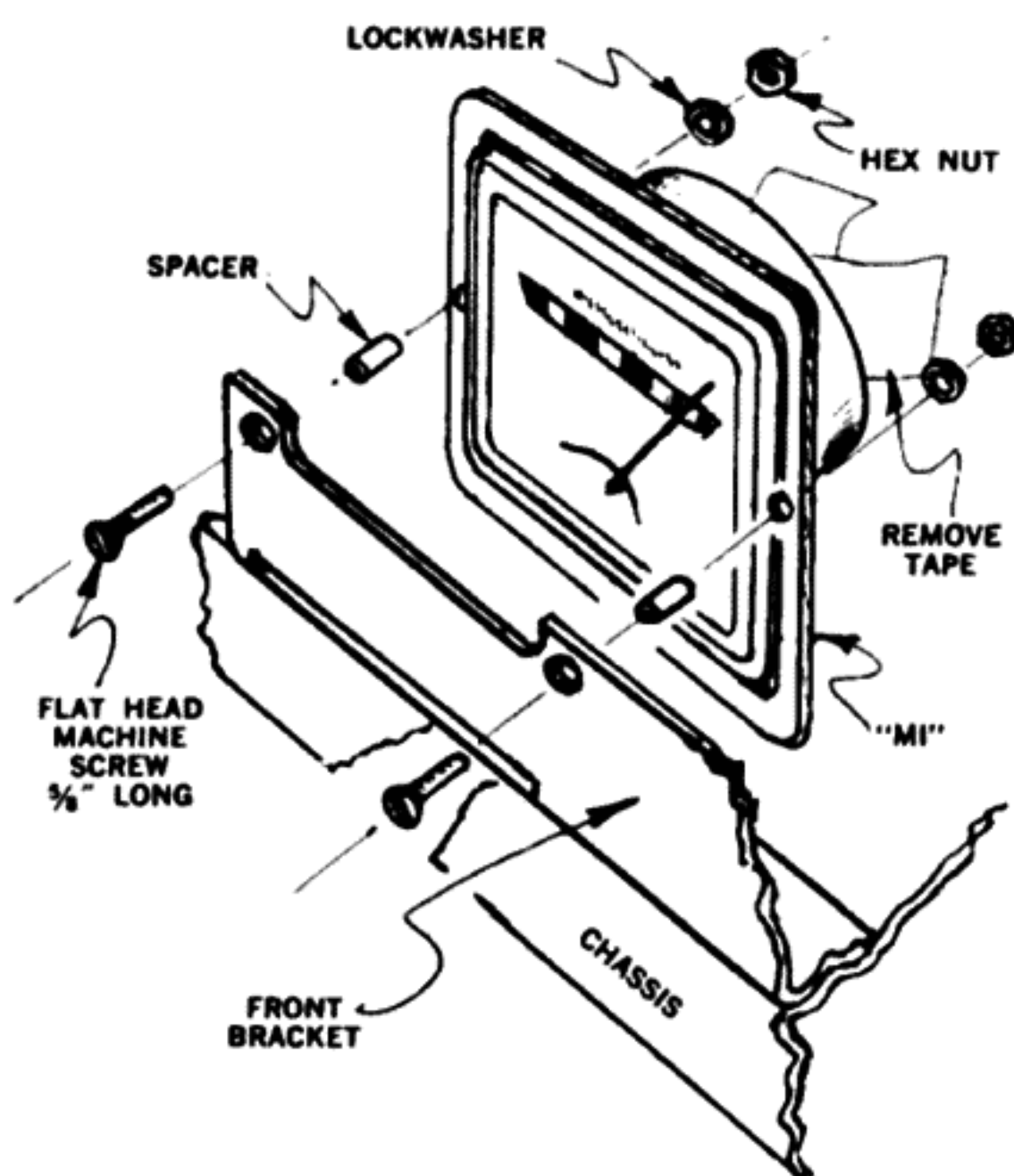

FIGURE 6

A-1-8. Install C1 (CEC 4X 40/250) in the slots marked C1, so that the little identification marks on the base (a triangle, square, and semicircle) agree with those shown on Chart A-2. Take your long nose pliers, grasp the outer mounting tabs firmly, and twist them 1/4 turn each. This will seat C1 firmly. (See Figure 7.)

A-1-9. Install an A-GR-5 Rubber grommet (this is the smaller of the two rubber grommets supplied) into the hole identified as hole "X" on Chart A-1.

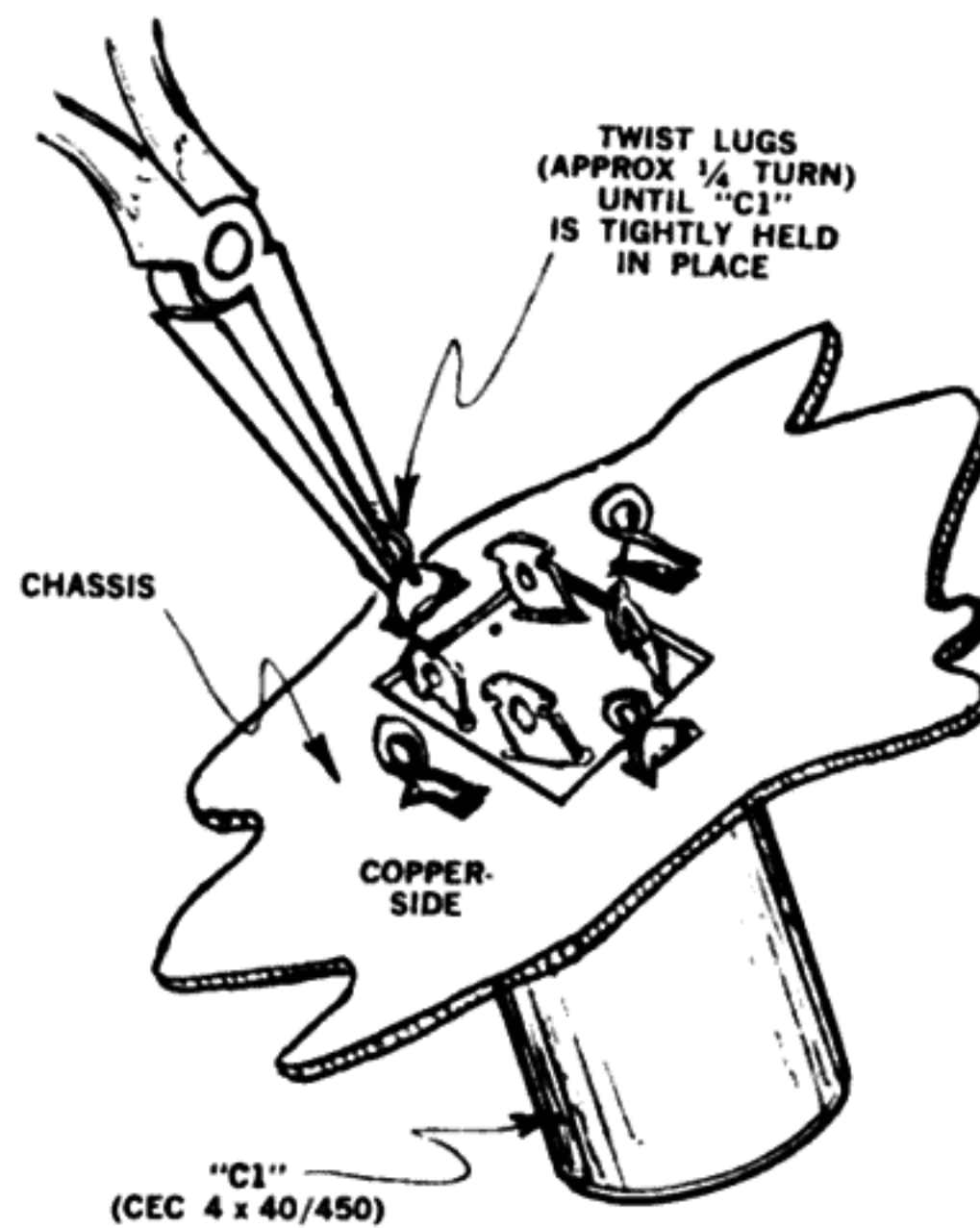

FIGURE 7

Electrical Assembly

INTRODUCTORY NOTES

To obtain the really fine performance this tuner is capable of, all lead lengths from components (resistors and capacitors) must be as short as possible. Follow the diagrams closely. A careful inspection of the pre-assembled front end will give you many hints as to the proper approach for mounting and trimming the parts. Keep all parts as close to the chassis as possible. This refers to all components and insulated wires. Bare wires, of course, should not touch the chassis, unless instructions indicate otherwise.

If, by mistake, the wire from one of the components is cut off too short, this can easily be corrected. Take a small piece of uninsulated wire (buss wire) and splice it on as shown in Figure 8.

The biggest source of mishaps, next to poorly soldered joints, are short circuits. A short circuit occurs when two uninsulated wires that are not supposed to, accidentally touch each other. It can also happen when a wire going towards one pin accidentally touches another pin nearby. The main body of a resistor or a capacitor is fully insulated so it does not matter if this part touches something. It is only the bare wires on the ends that you have to watch for. As the number of parts in the tuner starts to increase, you will realize how possible it is for short circuits to occur.

Extra quantities of black insulation material (spaghetti) have been supplied. Whenever you suspect that a short circuit may occur (either to the chassis, to another bare wire, or to another pin), slide a small piece of spaghetti over the bare wires in question. If you position the parts exactly as shown in the pictorials, you will not need to use spaghetti very frequently. However, it is better to be on the safe side if you have any doubts.

Check off each step as soon as it is completed. Cross off each (S) as soon as the soldering required is done. Connect your soldering iron now so that it will be ready.

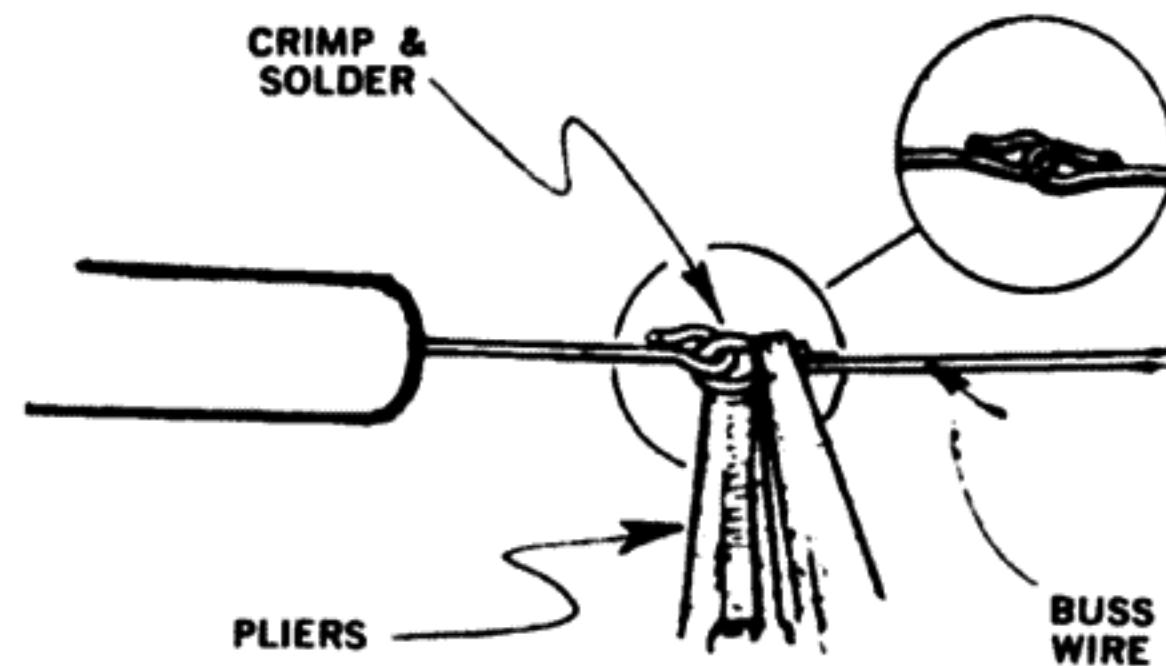
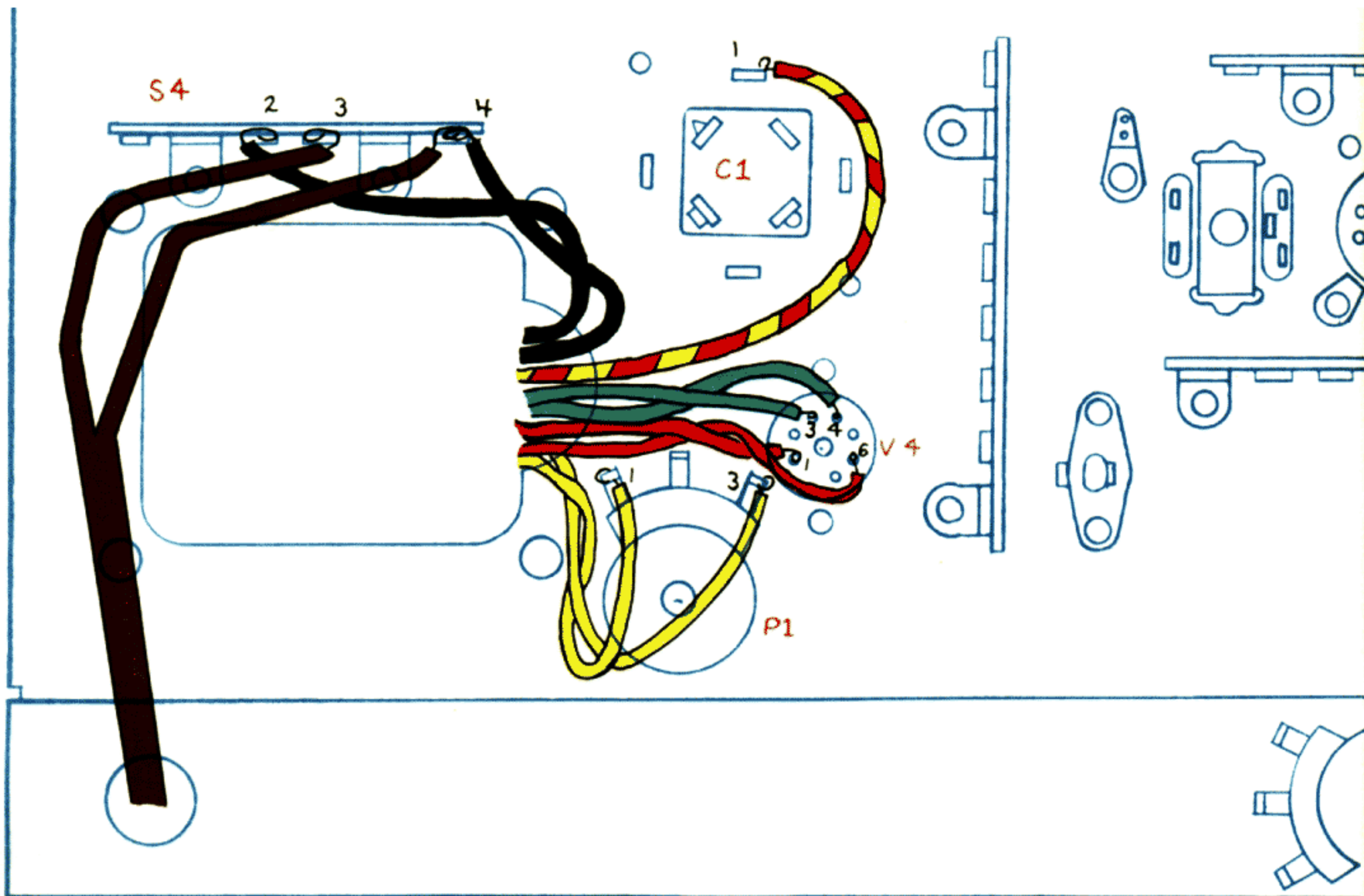

FIGURE 8.

Go slowly,
Read completely
and carefully...
HAVE FUN



Assembly Group B-1

(There is no card of parts for this page. Transformer leads are heavier than the wires you will be working with in the rest of the assembly. Exercise care in making mechanical joints to avoid short circuits to chassis.)

- B-1-1.** Twist the two black transformer wires once and connect either one to pin 2, S4 and the other to pin 4, S4. (Remember *do not solder* unless you see solder instruction in red.)
- B-1-2.** Connect the single yellow-red transformer wire to pin 1, C1 (S1).
- B-1-3.** Twist the two green transformer wires several times and connect one wire to pin 4, V4 and the other wire to pin 3, V4.
- B-1-4.** Twist the two red transformer wires several times and connect the longer wire to pin 6, V4 (S1) and the shorter wire to pin 1, V4 (S1).
- B-1-5.** Twist the two yellow transformer wires and connect either one to pin 1, P1, and the other to pin 3, P1.
- B-1-6.** Connect either wire of the brown AC line cord to pin 4, S4 and the other wire to pin 3, S4.

(Check all wires, connections, and soldered joints before continuing. Make sure your layout looks exactly like the diagram above. Keep all insulated wires and leads as close to the chassis as possible.)

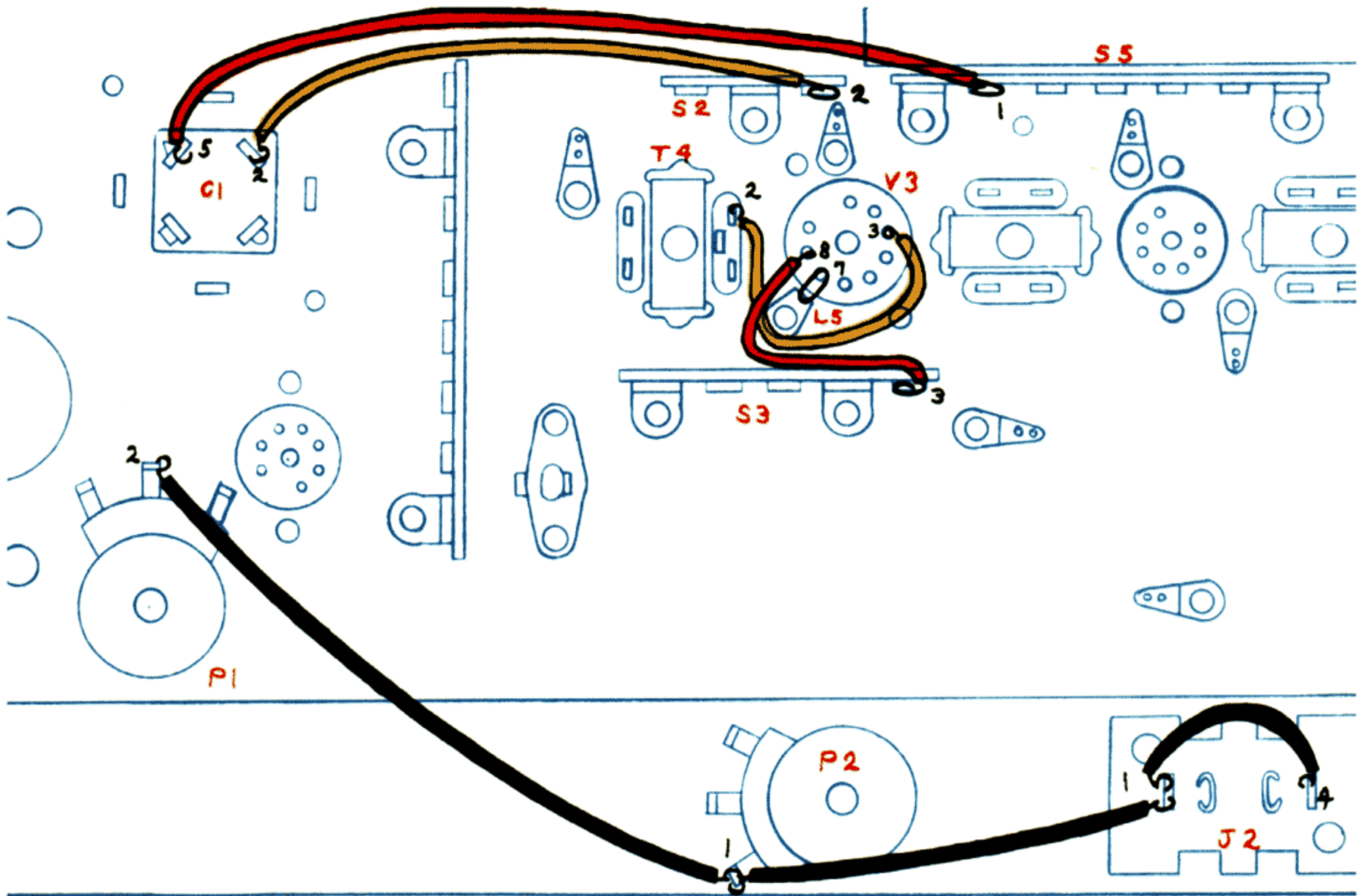

(Note: Position all insulated wires as close to the chassis as possible.)

Assembly Group B-2

- B-2-1.** Connect a 6 $\frac{1}{4}$ " red wire from pin 5, C1 to pin 1, S5.
- B-2-2.** Connect a 4 $\frac{1}{2}$ " orange wire from pin 2, C1 (S1) to pin 2, S2.
- B-2-2a.** Push pin 7, V3 away from the center and down until it touches L5 (S1). Make sure the pin is soldered securely to L5.
- B-2-3.** Connect a 3" orange wire from pin 2, T4 to pin 3, V3.
- B-2-4.** Connect a 2 $\frac{3}{4}$ " red wire from pin 8, V3 to pin 3, S3.
- B-2-5.** Connect a 2 $\frac{1}{4}$ " black wire from pin 1, J2 to pin 4, J2.
- B-2-6.** Connect a 4 $\frac{1}{2}$ " black wire from pin 2, P1 (S1) to pin 1, P2.
- B-2-7.** Connect a 3 $\frac{1}{4}$ " black wire from pin 1, P2 to pin 1, J2.

(Check all wires, connections, and soldered joints before continuing. Make sure your layout looks exactly like the diagram above.)

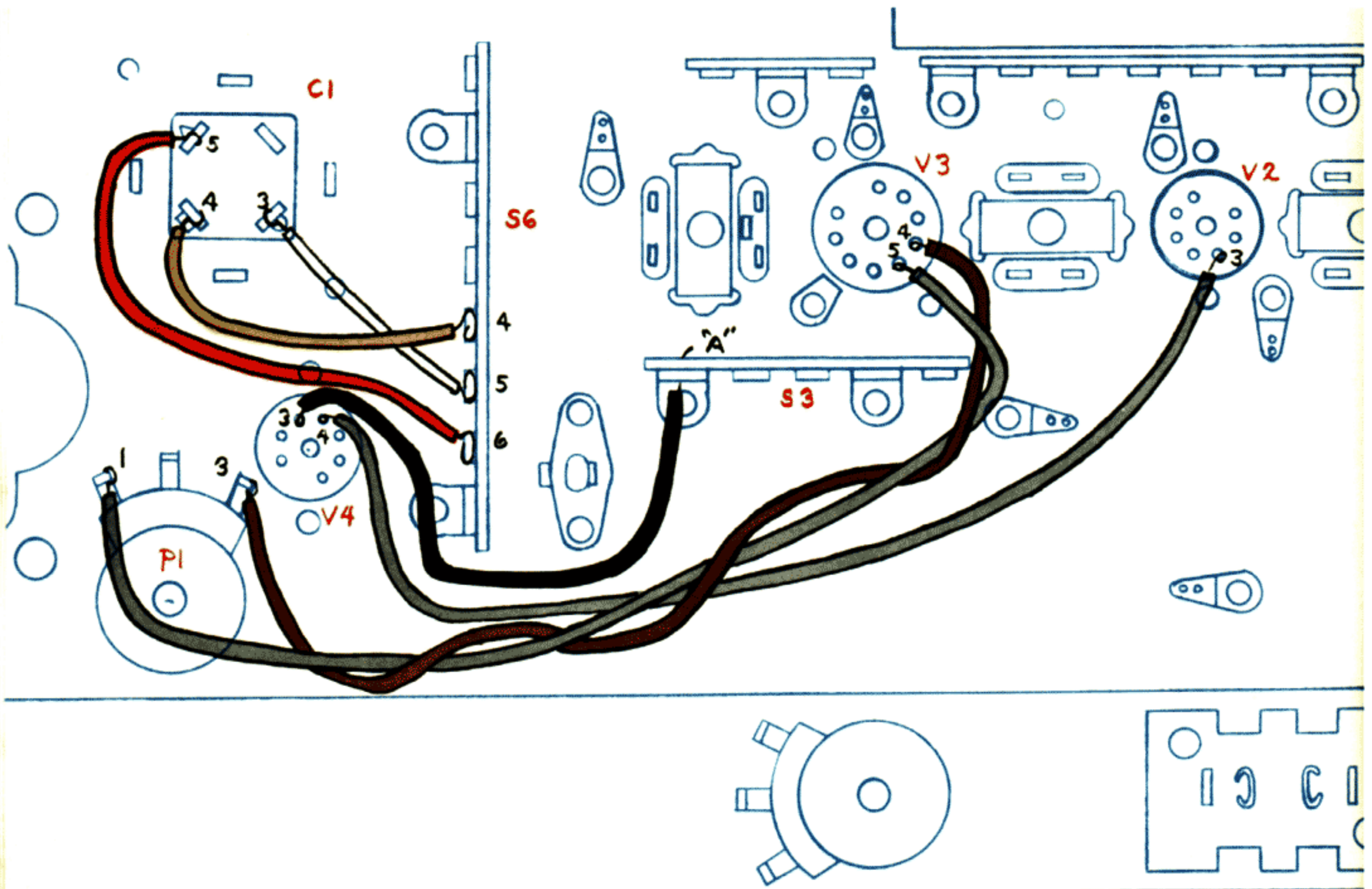

(Position all insulated wires as close to the chassis as possible. Check to insure that *bare uninsulated wires* or leads do not touch the chassis.)

Assembly Group B-3

- | | | |
|-------------------------------------|---------------|--|
| <input checked="" type="checkbox"/> | B-3-1. | Connect a 2½" white wire from pin 3, C1 (S1) to pin 5, S6. |
| <input checked="" type="checkbox"/> | B-3-2. | Connect a 3" orange wire from pin 4, C1 (S1) to pin 4, S6. |
| <input checked="" type="checkbox"/> | B-3-3. | Connect a 4¼" red wire from pin 5, C1 to pin 6, S6. |
| <input checked="" type="checkbox"/> | B-3-4. | Connect 4½" black wire from pin 3, V4 (S2) to ground lug A on S3 (ground lug A is the small hole on the side of S3 — notice pictorial above). Push wire through this hole, and bend it down. |
| <input checked="" type="checkbox"/> | B-3-5. | Connect a 7½" grey wire from pin 4, V4 to pin 3, V2. |
| <input checked="" type="checkbox"/> | B-3-6. | Connect one end of a 7" grey wire to pin 1, P1 (S2) and one end of a 6¼" brown wire to pin 3, P1 (S2). Twist these two wires together and connect the other end of the grey wire to pin 5, V3 (S1). Connect the other end of the brown wire to pin 4, V3 (S1). |

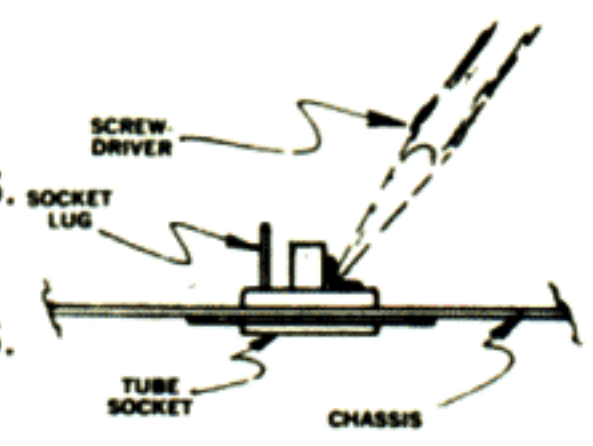
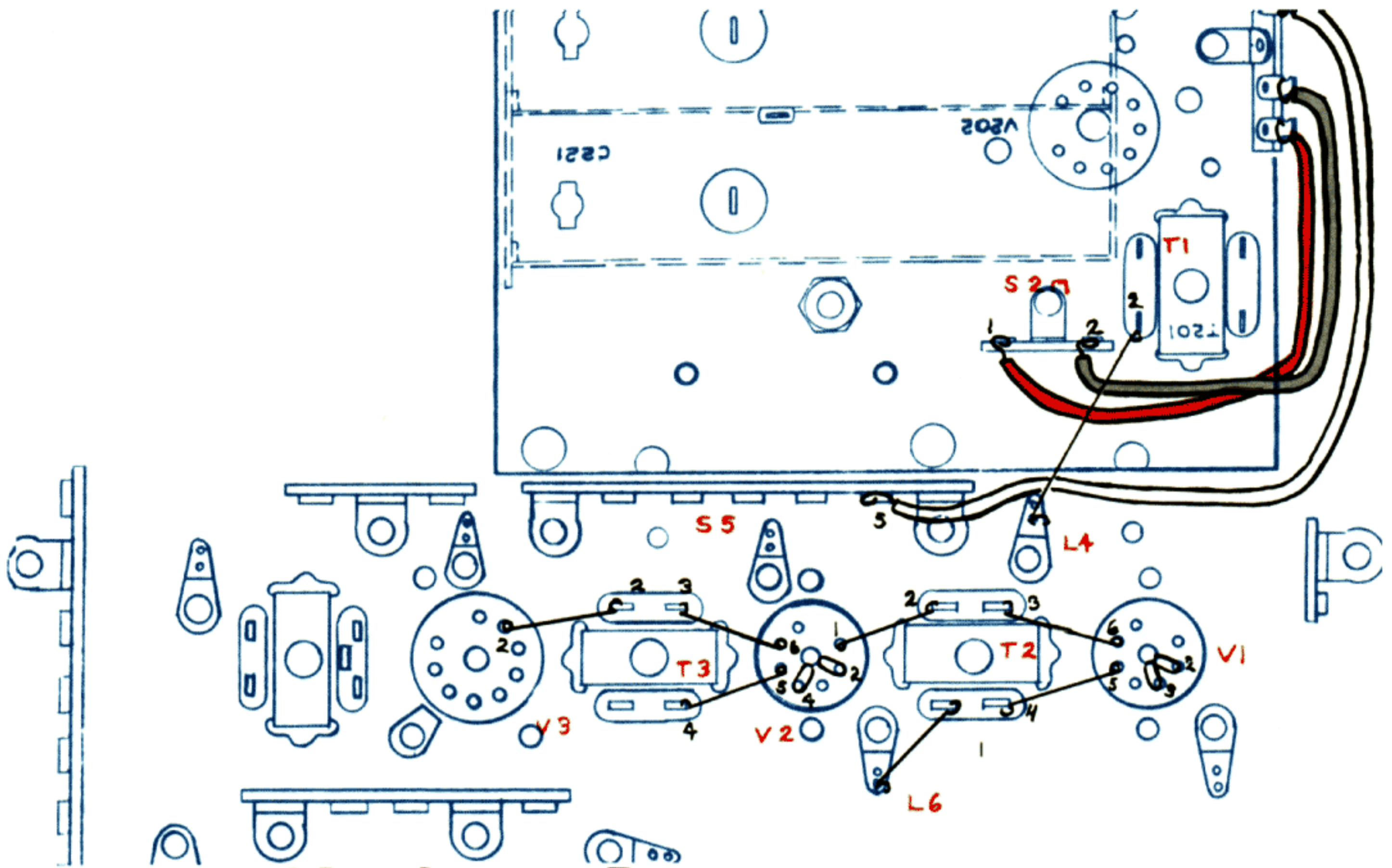

FIGURE 9

(Check all wires, connections, and soldered joints before continuing. Make sure your layout looks exactly like the diagram above.)



Assembly Group B-4

(Note: There is no card of wires for this page. One end of the colored leads discussed below is already connected to the preassembled front end. All other connections are made with the short pieces of un-insulated stiff "buss" wire that are provided. Please observe that the buss wire has *not* been cut to length. It can easily be cut by superimposing a piece of buss wire over the pictorial diagram. As the diagrams are all full scale, you can trim the buss wire on this basis. Just allow $\frac{1}{4}$ " extra on each end for a good mechanical joint. Please note that un-insulated buss wires should be as short as possible. Do *not* permit them to touch the chassis or other bare wires and pins accidentally, as this will cause short circuits. Use the "spaghetti" wherever you feel it necessary to prevent short circuits.)

- | | |
|--|---|
| <p><input checked="" type="checkbox"/> B-4-1. Bend pins 2 and 3, V1 forward until they make contact with the center post of V1. Bend pins 2 and 4, V2 forward until they make contact with the center post of V2. See Figure 9.</p> | <p><input checked="" type="checkbox"/> B-4-7. Connect a buss wire from pin 4, T3 to pin 5, V2 (S1).</p> |
| <p><input checked="" type="checkbox"/> B-4-2. Connect the white wire on the preassembled front end to pin 5, S5.</p> | <p><input checked="" type="checkbox"/> B-4-8. Connect a buss wire from pin 1, V2 (S1) to pin 2, T2.</p> |
| <p><input checked="" type="checkbox"/> B-4-3. Connect the red wire on the front end to pin 1, S2M.</p> | <p><input checked="" type="checkbox"/> B-4-9. Connect a buss wire from L6 to pin 1, T2 (S1).</p> |
| <p><input checked="" type="checkbox"/> B-4-4. Connect the grey wire on the front end, to pin 2, S2M.</p> | <p><input checked="" type="checkbox"/> B-4-10. Connect a buss wire from pin 4, T2 to pin 5, V1 (S1).</p> |
| <p><input checked="" type="checkbox"/> B-4-5. Connect a buss wire from pin 2, V3 (S1) to pin 2, T3.</p> | <p><input checked="" type="checkbox"/> B-4-11. Connect a buss wire from pin 3, T2 to pin 6, V1 (S1).</p> |
| <p><input checked="" type="checkbox"/> B-4-6. Connect a buss wire from pin 3, T3 to pin 6, V2 (S1).</p> | <p><input checked="" type="checkbox"/> B-4-12. Connect a buss wire from L4 to pin 2, T1 (S1).</p> |

(Check all wires, connections, and soldered joints before continuing. Make sure your layout looks exactly like the diagram above.)

* black insulation material

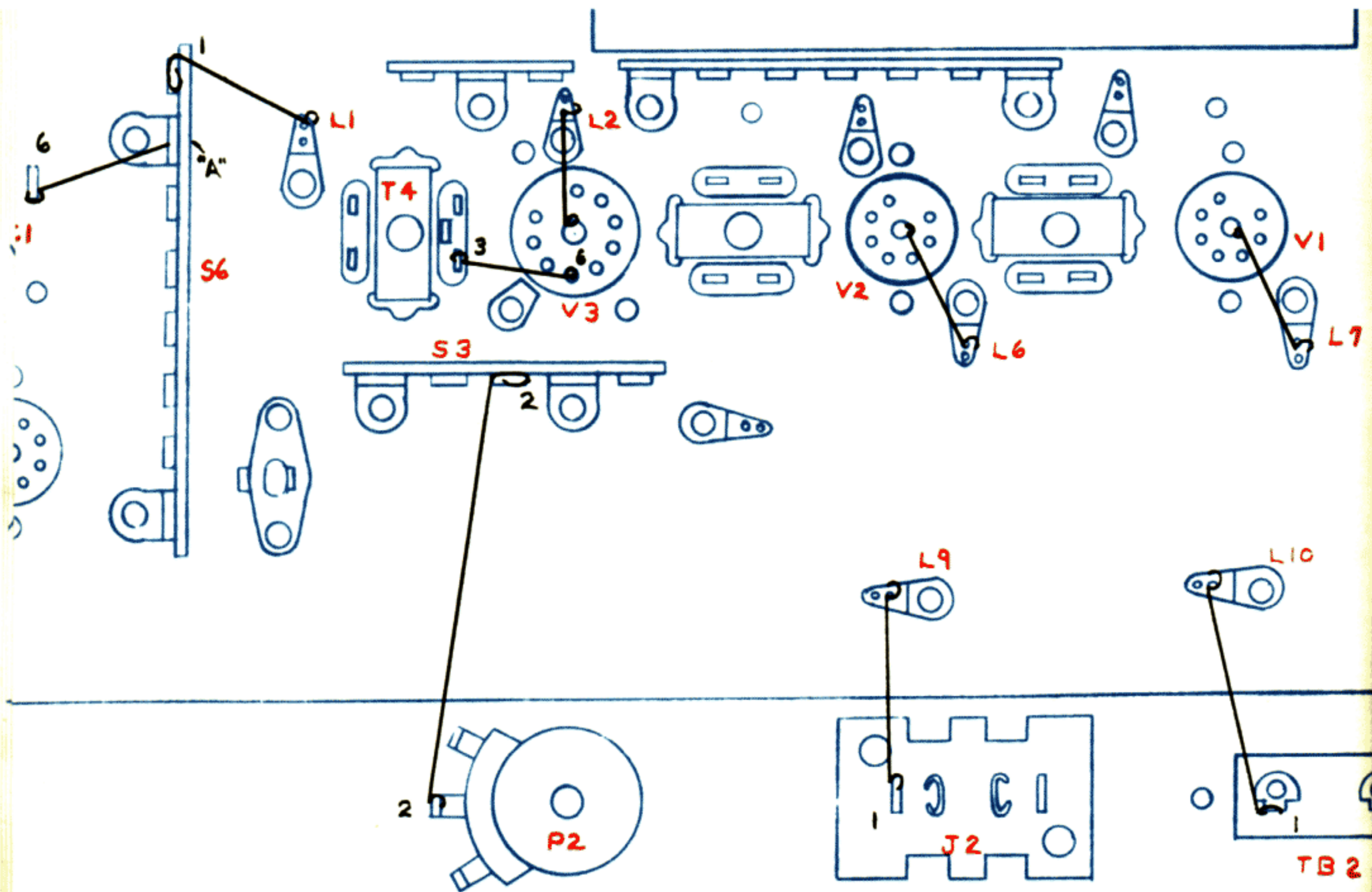

Assembly Group B-5

(Note: There is no card of wires or components for this page.)

- B-5-1.** Connect a buss wire (see instructions for buss wire installation on Reference B-4 page 15) from pin 1, S6 to L1.
- B-5-2.** Connect a buss wire from pin 6, C1 (S1) to ground lug "A" S6 (S1).
- B-5-3.** Connect a buss wire from pin 3, T4 (S1) to pin 6, V3 (S1).
- B-5-4.** Connect a buss wire from L2 to center post V3. This piece of buss wire should be positioned close to the chassis and away from all the other pins on V3.
- B-5-5.** Connect a buss wire from pin 2, S3 to pin 2, P2 (S1).
- B-5-6.** Connect a buss wire from L6 to center post V2 (S1). Make certain that you also solder the bent pins 2 and 4 of V2 to the center post. This piece of buss wire should also be positioned close to the chassis and away from all the other pins on V2.
- B-5-7.** Connect a buss wire from L7 to center post, V1 (S1). Make certain that you also solder the bent pins 2 and 3 of V1 to the center post. The comments in step B-5-6 apply here too.
- B-5-8.** Connect a buss wire from pin 1, J2 to L9 (S1).
- B-5-9.** Connect a buss wire from pin 1, TB-2 to L10 (S1).

(Check all wires, connections, and soldered joints before continuing. Make sure your layout looks exactly like the diagram above).

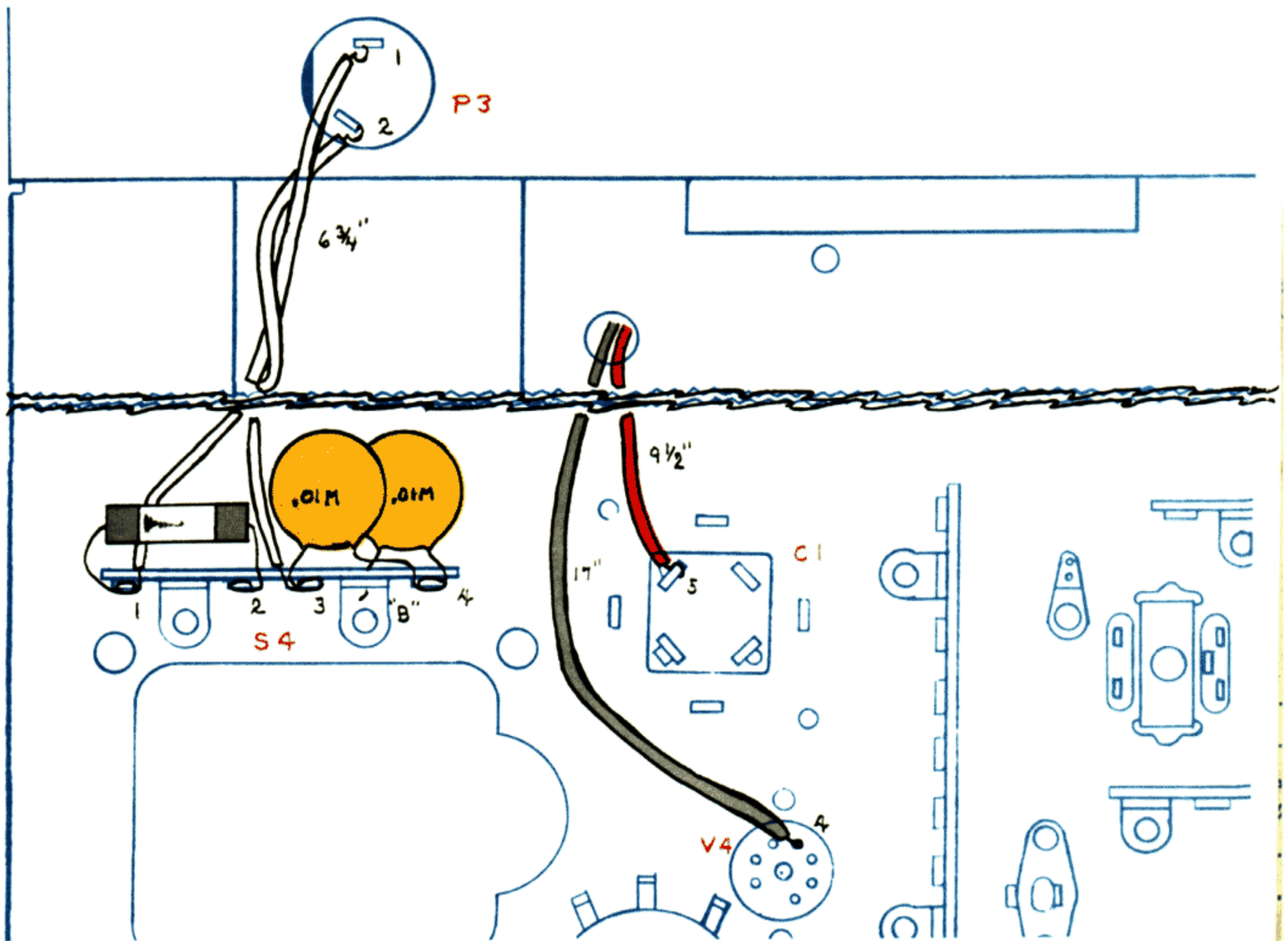

Assembly Group B-6

(Note: Keep all component leads as *short* as possible and position them *close* to the chassis exactly as shown in the pictorial. You will now be soldering joints that have many leads connected to them. Make sure that all the leads on the joint are soldered. You will also find yourself soldering joints which are hard to reach because other leads and components are in the way. Carefully bend these interfering items out of the way so that you can insert the soldering iron without causing damage. Once the joint has been soldered, carefully re-position all the wires and components that you bent away).

- B-6-1.** Connect a 9½" red wire to pin 5, C1 (S3). Push the other end through the grommet in the chassis but do not connect it yet.

B-6-5. Connect an MDV-½ fuse from pin 1, S4 to pin 2, S4 (S2).
- B-6-2.** Connect a 17" grey wire to pin 4, V4 (S3). Push the other end through the grommet in the chassis but do not connect it yet.

CAUTION: 117 Volts will be passing through the fuse when the tuner is in operation. Make certain that no part of the fuse or the leads going to the fuse touches either the chassis or other bare wires.
- B-6-3.** Connect a CC.01M from pin 4, S4 to ground lug B (S1). The end going to ground lug should be pushed through the little hole in the bottom and simply bent back before soldering. Once again trim all leads and wires so they are as short as possible. This is the case with all resistors, capacitors, and other components you will be working with from here on.

B-6-6. Connect one end of a 6¾" heavy white wire to pin 1, S4 (S2). Connect one end of a second 6¾" heavy white wire to pin 3, S4 (S3). Twist these two wires many times around each other. Connect the other end of one of the wires to pin 1, P3 (S1). Connect the other end of the remaining wire to pin 2, P3 (S1). Either white wire can go to either pin on P3.
- B-6-4.** Connect a CC.01M from pin 4, S4 (S4) to pin 3, S4.

(Check all wires, connections, and soldered joints before continuing. Make sure your layout looks exactly like the diagram above.)

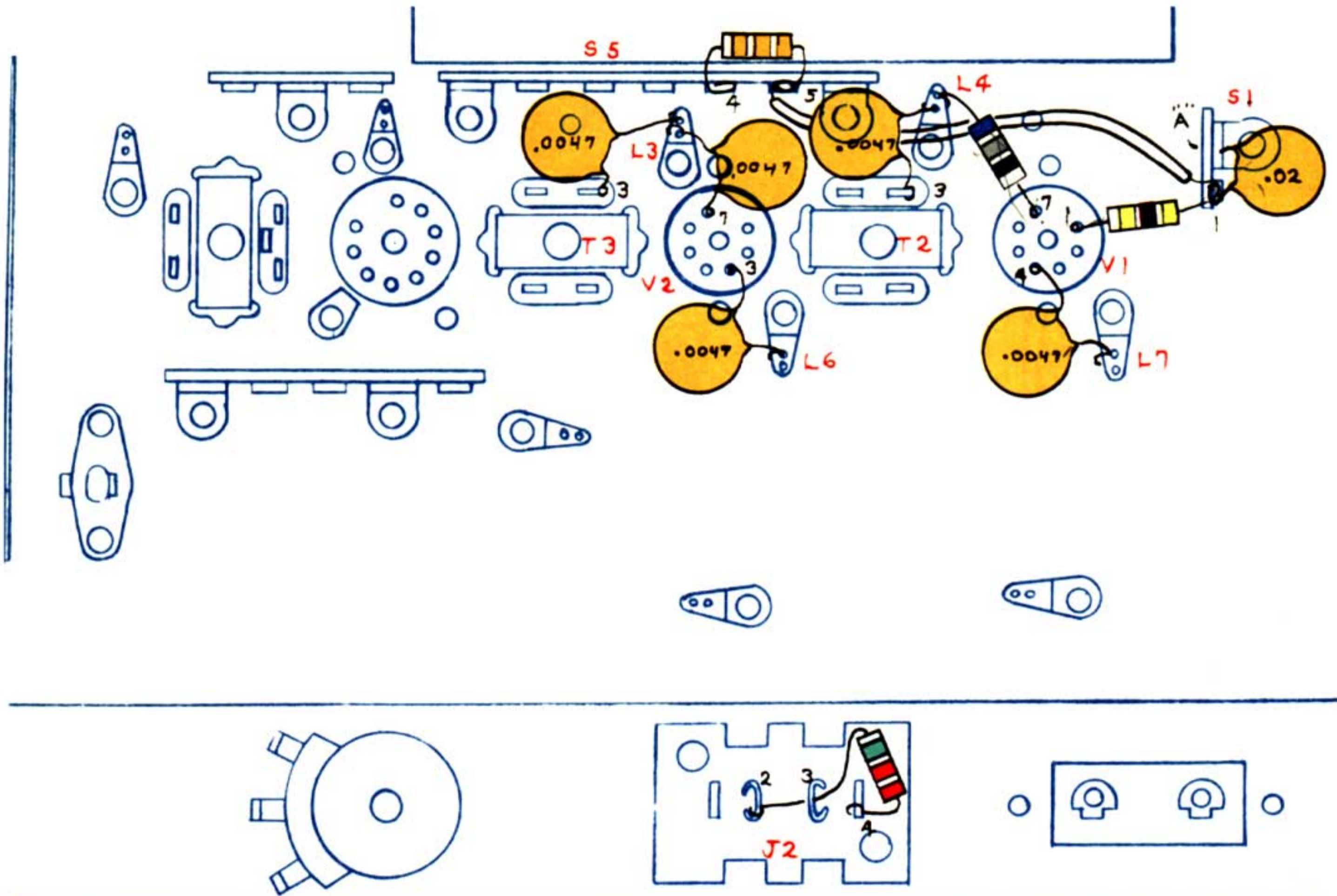

Assembly Group B-7

- B-7-1.** Connect a CC .02 from pin 1, S1 to ground lug A on S1 (S1).
- B-7-2.** Connect a 4" wire from pin 1, S1 to pin 5, S5.
- B-7-3.** Connect a CC-.0047 from pin 4, V1 to L7 (S2).
- B-7-4.** Connect a CC-.0047 from pin 3, T2 to L4.
- B-7-5.** Connect a CC-.0047 from pin 3, V2 to L6 (S3).
- B-7-6.** Connect a CC-.0047 from pin 7, V2 to L3.
- B-7-7.** Connect a CC-.0047 from pin 3, T3 to L3.
- B-7-8.** Connect a 470k resistor (yellow, purple, yellow) from pin 1, S1 (S3) to pin 1, V1.
- B-7-9.** Connect a 68 ohm resistor (blue, grey, black) from pin 7, V1 (S1) to L4 (S3).
- B-7-10.** Connect a 33K resistor (orange, orange, orange) from pin 4, S5 to pin 5, S5 (S3).
- B-7-11.** Connect one end of a 2.2 M resistor (red, red, green) to pin 4, J2 (S2). Push the other end through the hole in Pin 3, J2 and connect to pin 2, J2. Solder the hole in pin 3, J2. (S2).

(Check all wires, connections, and soldered joints before continuing. Make sure your layout looks exactly like the diagram above.)

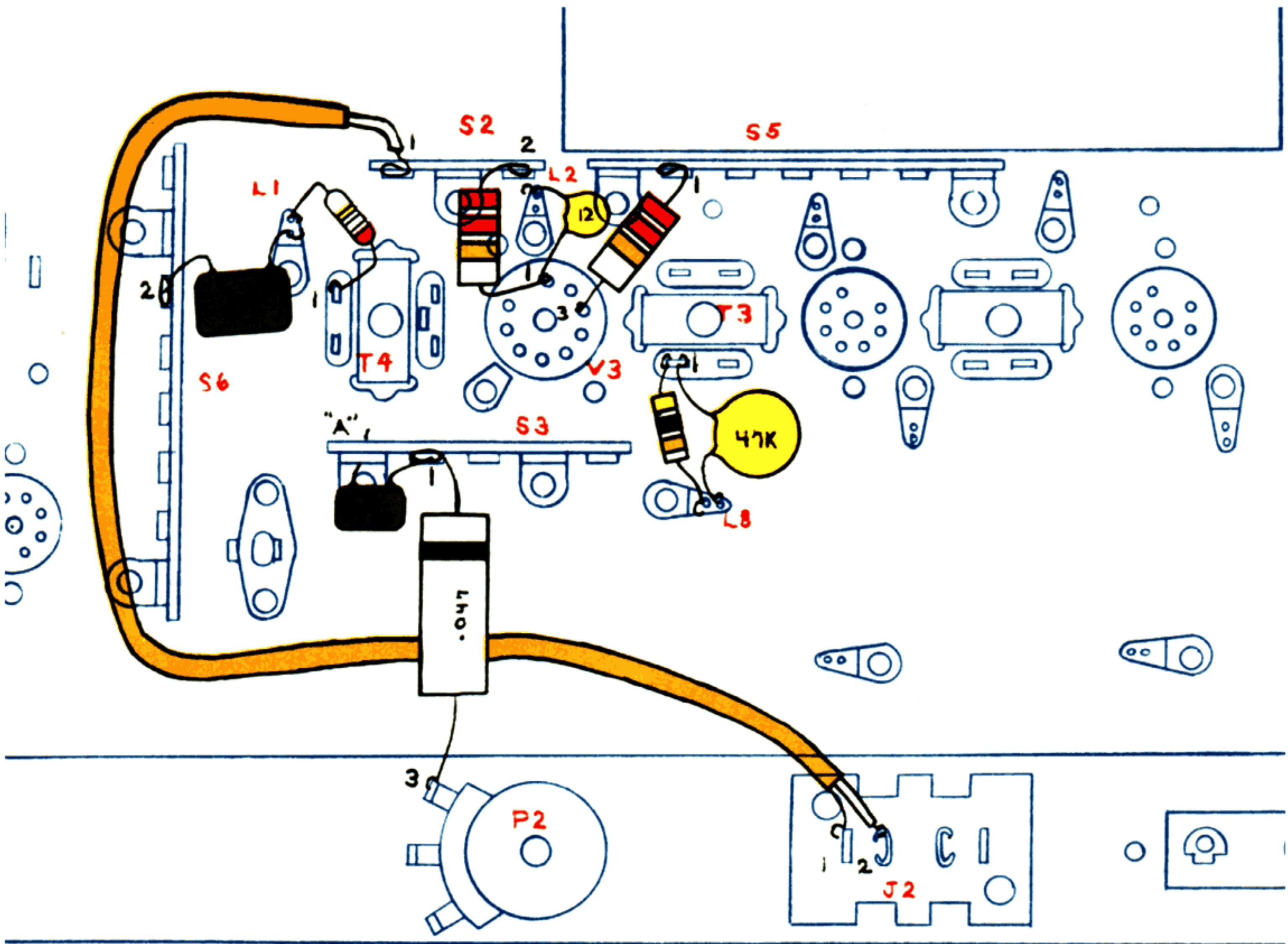

Assembly Group B-8

- | | |
|---|---|
| <p><input type="checkbox"/> B-8-1. Take the 10$\frac{3}{4}$" orange mic lapel wire, clip off the buss wire (the uninsulated lead) from one end, and connect the remaining insulated wire to pin 1, S2. Connect the insulated wire on the opposite end to pin 2, J2 (S2), and the uninsulated buss wire to pin 1, J2 (S4). Make sure that the end of the clipped buss wire is not shorting against other components.</p> | <p><input checked="" type="checkbox"/> B-8-6. Connect a 22K large resistor (red, red, orange) from pin 3, V3 (S2) to pin 1, S5.</p> |
| <p><input checked="" type="checkbox"/> B-8-2. Connect a CC 47 k capacitor from pin 1, T3 to L8.</p> | <p><input type="checkbox"/> B-8-7. Connect a CC 12 from pin 1, V3 to L2 (S2).</p> |
| <p><input checked="" type="checkbox"/> B-8-3. Connect a 47 k resistor (yellow, purple, orange) from pin 1, T3 to L8 (S2).</p> | <p><input checked="" type="checkbox"/> B-8-8. Connect a 22K large resistor (red, red, orange) from pin 2, S2 to pin 1, V3.</p> |
| <p><input checked="" type="checkbox"/> B-8-4. Connect the end of a CPM .047 with a black band to pin 1, S3. Connect the other end to pin 3, P2 (S1).</p> | <p><input checked="" type="checkbox"/> B-8-9. Connect a CM 470 from L1 to pin 2, S6.</p> |
| <p><input type="checkbox"/> B-8-5. Connect a CM 330 from pin 1, S3 to ground Lug A on S3.</p> | <p><input type="checkbox"/> B-8-10. Connect the end of the diode with the red band to pin 1, T4 (S1). Connect the other end to L1 (S3). A diode is very sensitive to heat so leave at least $\frac{1}{2}$" of wire on each end, and use extreme caution with the soldering iron. Make sure the iron tip is clean and well tinned so the heat will be transmitted quickly.</p> |

(Check all wires, connections, and soldered joints before continuing. Make sure your layout looks exactly like the diagram above.)

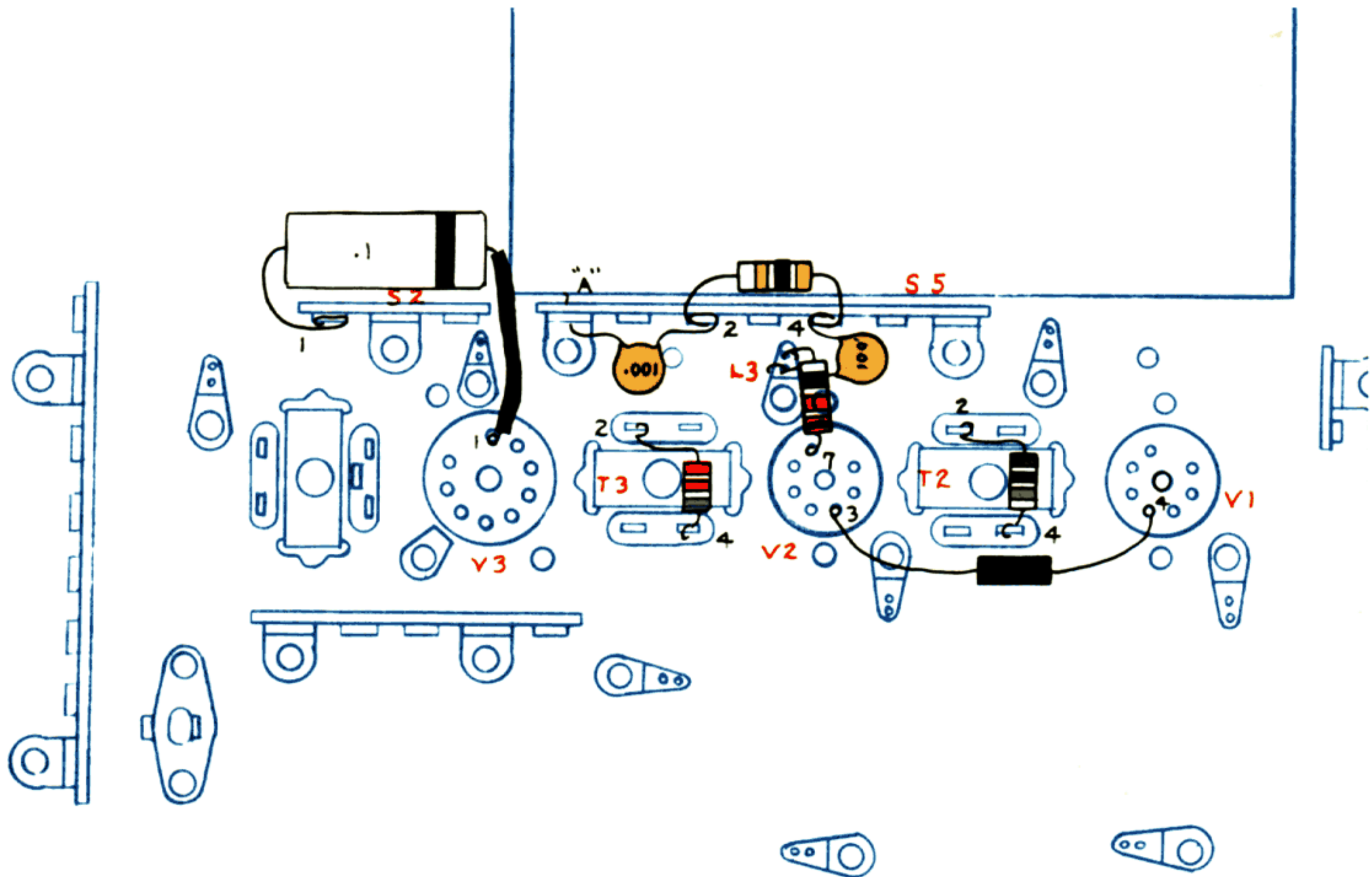

Assembly Group B-9

- B-9-1.** Connect a choke (1.0 mh) from pin 4, V1 to pin 3, V2 (S3).
- B-9-2.** Connect a CC.1 (brown, black, grey) from pin 2, T2 (S2) to pin 4, T2 (S2). Position this capacitor so that it does not block the hole in the bottom of the transformer can (the alignment hole).
- B-9-3.** Connect a 220 ohm resistor (red, red, brown) from pin 7, V2 (S2) to L3.
- B-9-4.** Connect a CC .001 from pin 4, S5 to L3 (S4).
- B-9-5.** Connect a CC .001 from pin 2, S5 to ground lug A, S5 (S1).
- B-9-6.** Connect a 47 K resistor (yellow, purple, orange) from pin 2, S5 to pin 4, S5 (S3).
- B-9-7.** Slide a 1" piece of black insulation material (spaghetti) over the end of a CPM .1 with the black band, and connect this end to pin 1, V3, (S3). Connect the other end to pin 1, S2.
- B-9-8.** Connect a CC .22 (red, red, grey) from pin 2, T3 (S2) to pin 4, T3 (S2). Position this capacitor so it does not block the large hole in the bottom of the transformer can (alignment hole).

(Check all wires, connections, and soldered joints before continuing. Make sure your layout looks exactly like the diagram above.)

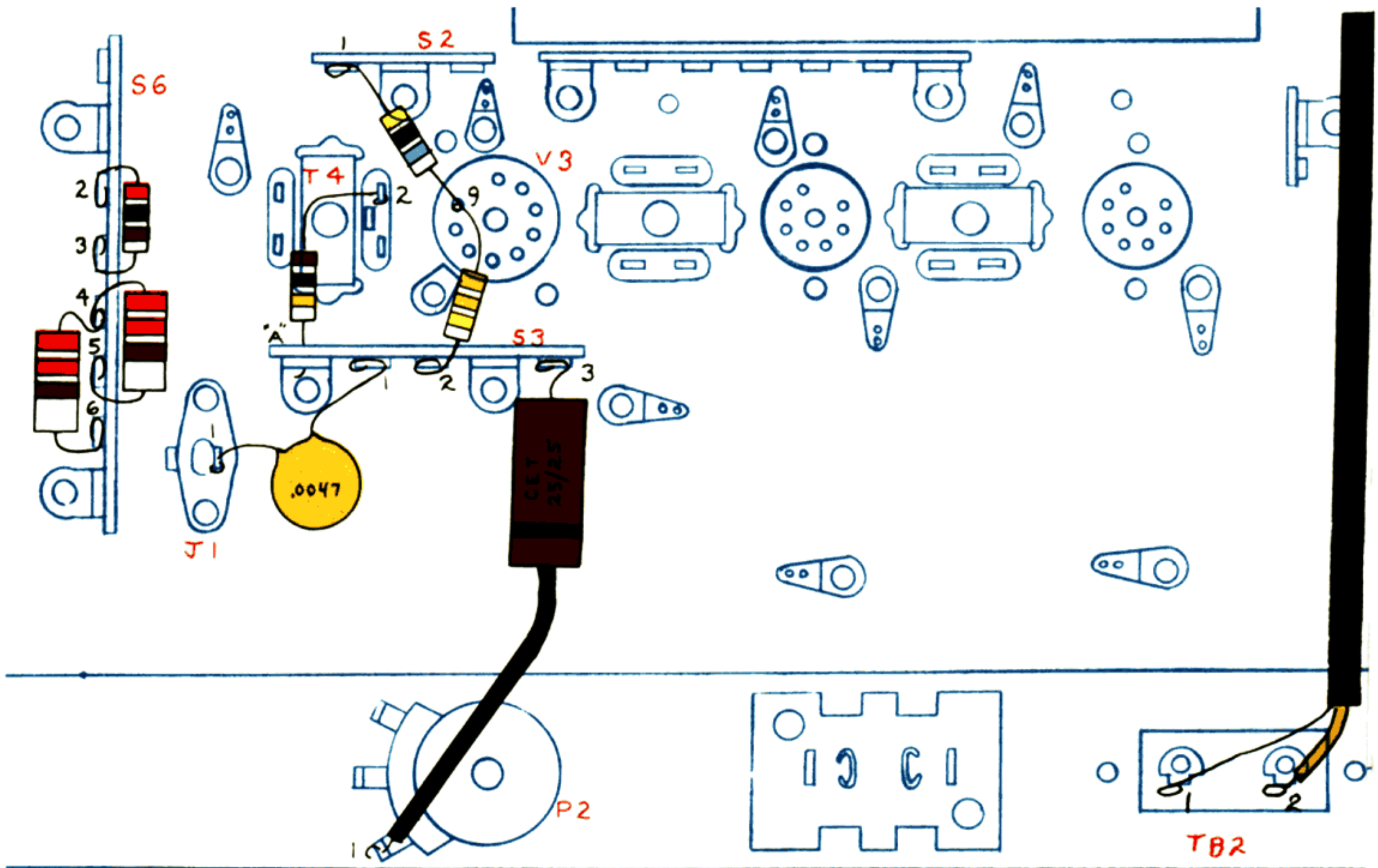

Assembly Group B-10

- B-10-1.** Take the CET 25/25, slide a 1" piece of black insulation over the wire on the end with a black band, and connect to pin 1, P2. Connect the other end to pin 3, S3.
- B-10-2.** Connect a CC .0047 from pin 1, S3 to pin 1, J1 (**S1**).
- B-10-3.** Connect a 10K resistor (brown, black, orange) from pin 2, T4 to ground lug A, S3. Arrange the resistor so it does not block the hole in the bottom of the transformer can.
- B-10-4.** Connect a 330 K resistor (orange, orange, yellow) from pin 9, V3 to pin 2, S3 (**S2**).
- B-10-5.** Connect a 4.7 M resistor (yellow, purple, green) from pin 1, S2 to pin 9, V3.
- B-10-6.** Connect a 270 ohm resistor (red, purple, brown) from pin 2, S6 to pin 3, S6.
- B-10-7.** Connect a large 220 ohm resistor (red, red, brown) from pin 4, S6 to pin 6, S6 (**S2**).
- B-10-8.** Connect a large 220 ohm resistor (red, red, brown) from pin 4, S6 (**S3**) to pin 5, S6.
- B-10-9.** Take the large black antenna cable. At one end you will observe two wires; one uninsulated buss wire, the other shielded. Connect the 'uninsulated buss to pin 1, TB-2 (**S2**). Connect the insulated wire to pin 2, TB2 (**S1**). Do not connect the other end yet.

(Check all wires, connections, and soldered joints before continuing. Make sure your layout looks exactly like the diagram above.)

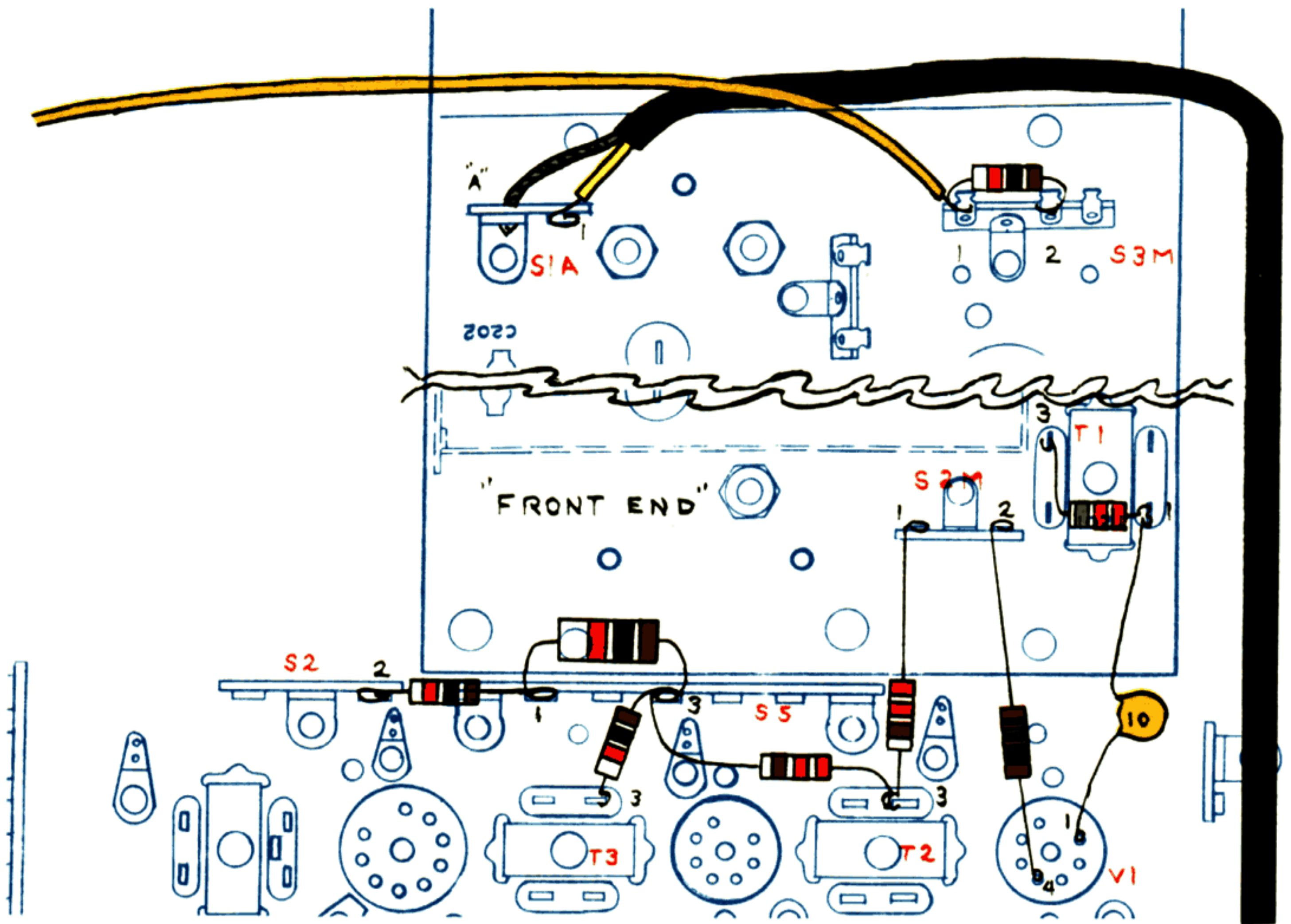

Assembly Group B-11

(Note: Be careful of short circuits. Make sure that bare uninsulated leads are not touching wires, terminal pins, the chassis, or any metal objects other than what they are supposed to touch.)

- B-11-A.** Connect the opposite end of the black antenna cable now. The insulated wire in the center goes to pin 1, S1A (S2). The stranded wire connects to ground lug A, S1A (S1).
- B-11-1.** Connect a 1 K resistor (brown, black, red) from pin 1, S3M to pin 2, S3M (S3).
- B-11-2.** Connect a CC .22 (red, red, grey) from pin 1, T1 to pin 3, T1 (S3). Part of pin 3, T1 has leads already soldered to it at the factory. The present connection should be made to the part of the pin above the pre-soldered portion. In positioning the capacitor make sure it does not block the hole in the bottom of the transformer can.
- B-11-3.** Connect a CC .10 from pin 1, V1 (S2) to pin 1, T1 (S2).
- B-11-4.** Connect a choke (1.0 mh) from pin 4, V1 (S3) to pin 2, S2M (S2).
- B-11-5.** Connect a 220 ohm resistor (red, red, brown) from pin 3, S5 to pin 3, T2.
- B-11-6.** Connect a 220 ohm resistor (red, red, brown) from pin 3, T2 (S4) to pin 1, S2M (S2).
- B-11-7.** Connect a 1 K resistor (brown, black, red) from pin 3, S5 to pin 3, T3 (S3).
- B-11-8.** Connect a 1 K large resistor (brown, black, red) from pin 1, S5 to pin 3, S5 (S3).
- B-11-9.** Connect a 1 K resistor (brown, black, red) from pin 2, S2 (S3) to pin 1, S5 (S4).
- B-11-10.** Connect a 12" orange wire to pin 1, S3M (S2). Push the other end of the orange wire through the grommet in the chassis, but do not connect.

(Check all wires, connections, and soldered joints before continuing. Make sure your layout looks exactly like the diagram above.)

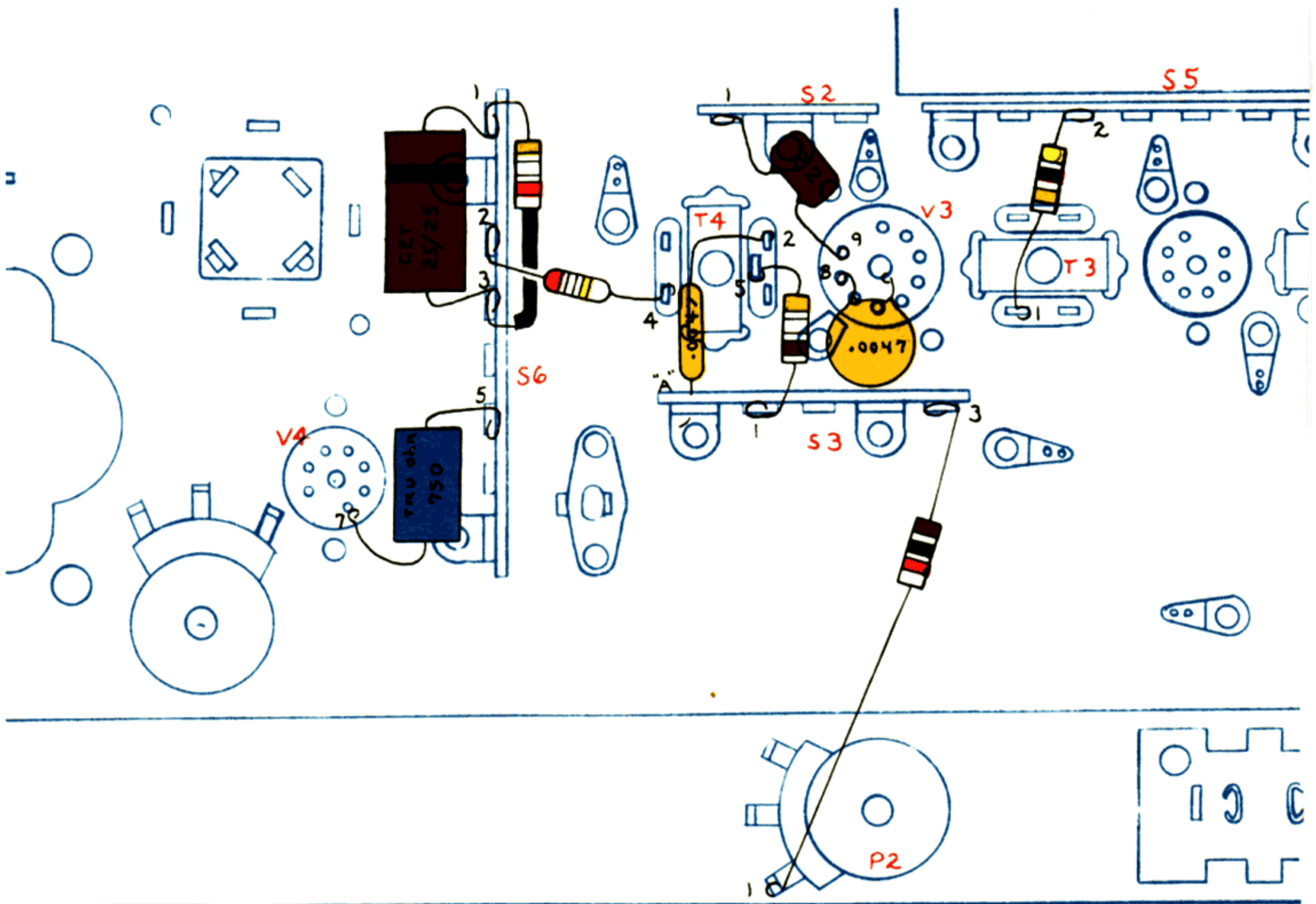

Assembly Group B-12



B-12-1.

Connect a 47 K resistor (yellow, purple, orange) from pin 2, S5 (S3) to pin 1, T3 (S3). Do not obstruct alignment hole.



B-12-2.

Connect a CM 22 from pin 1, S2 (S4) to pin 9, V3 (S3).



B-12-3.

Connect a 1 K resistor (brown, black, red) from pin 3, S3 (S3) to pin 1, P2 (S4).



B-12-4.

Connect a 390 ohm resistor (orange, white, brown) from pin 5, T4 (S1) to pin 1, S3 (S4).



B-12-5.

Connect a CC .0047 from center post V3 (S2) to pin 8, V3 (S2). Make sure that all leads connected to the center post are also soldered. Position the capacitor so it stands up vertically.



B-12-6.

Connect a CC .0047 from pin 2, T4 (S3) to ground lug A, S3 (S4). Position the capacitor so that it does not block the alignment hole in the bottom of the transformer can.



B-12-7.

Connect the red end of a diode to pin 2, S6 (S3). Connect the other end to pin 4, T4 (S1). Leave at least 1/2" of lead wire on each end of the diode, and be very cautious as to the application of heat.



B-12-8.

Take the CET 25/25 and connect the end with the black band to pin 1, S6. Connect the other end to pin 3, S6.



B-12-9.

Slide 1/2" strip of black insulation (spaghetti) over the end of a 3.9 K resistor (orange, white, red) and connect this end to pin 3, S6 (S3). The other end is connected to pin 1, S6 (S3).



B-12-10.

Connect an RW 750 ohm resistor from pin 5, S6 (S3) to pin 7, V4 (S1). The RW 750 gives off a considerable amount of heat in actual use. It is very desirable that you position all wires and resistors that are near this component in such a manner that they do not actually touch the body of the RW 750.

(Check all wires, connections, and soldered joints before continuing. Make sure your layout looks exactly like the diagram above.)

Very Important!

the Double Check System

The main part of the electrical assembly is complete. It is time to pause for a moment and make sure that there are no errors, and that every joint has been soldered properly. It is quite understandable that at this stage of the assembly there will be a tremendous incentive to forge ahead quickly to finish the job. Unfortunately this attitude can cause you to overlook a small error that will lead to serious and expensive damage to your tuner. Stop for a moment, RELAX, and check over your work.

An easy method of doing this has been provided. Call in a friend or another member of the family. Have them look over Figure A-2. On this diagram of the underside of the chassis, a series of numbers have been placed next to each pin or terminal. These numbers indicate the number of wires and leads (including those from resistors or capacitors) that have been soldered to that pin. While you count off the number of leads on each pin and terminal, your assistant can check your count against the chart. When you count these leads going to pin 1 of V3, your helper will observe that this agrees with his chart and place a small check mark on it. This will be continued until the entire tuner is checked over. It will seldom take more than 10 minutes for this complete check.

While you are counting the wires, you can also be checking for short circuits and proper soldering. It would be very handy if you had a tool with a small sharp point (like an ice pick) to probe the connections and make certain they are soldered properly. A pencil with a sharp point can also be used. Even the most meticulous worker can make a mistake or have a poorly soldered joint. LOOK SHARP! Move every lead and wire a little bit to insure it is not accidentally causing a short circuit with some other wire or pin.

If a mistake is caught and it involves a component which is now too short to reach the correct

pin, refer to Fig. 8 on splicing a piece of buss wire. This will work quite well and eliminate the need for purchasing a replacement.

Final Assembly PART 1

(Before beginning the final steps, pick up the tuner chassis, turn it over, and shake it violently. This is to get all the little pieces of wire out of the unit. Make certain that there are no pieces caught in the crevices of the transformer cans as this could cause a serious short circuit.)



A-2-1.

Position the tuner chassis in front of you as shown in Chart A-1. Connect the red wire coming through the grommet to pin 1, on the back of the meter (S1). Connect the orange wire to pin 2, back of the meter (S1).



A-2-3.

There are two pilot light sockets. Plug in a pilot light in each socket. One has a white wire attached to it and the other does not. Take the pilot light socket *without* the wire and connect the grey lead passing through the grommet to one of the two holes on the back of the socket (S). Solder the lead carefully to make sure no excess solder drips down the back, and that no part of the bare wire touches the body of the tube socket. Clip the pilot light socket into the cutout in the back of the meter, by compressing the prongs slightly.



A-2-4.

Mounting the front panel (refer to Figure 10). Turn the tuner around so that it faces you. Take the two spring clip fasteners and slip them over the two holes in the bracket under the tuning shaft. The split portion of the fastener goes to the rear. Remove the hex nut used on P3 to hold it on to the front. Mount the face plate (front panel) over

the shafts and snugly up against the chassis. Thread the hex nut back over P3 finger-tight so that the panel stays on.



A-2-5.

Take two flat head machine screws and insert them through the bottom pair of holes in the front panel, through the bracket, and screw them firmly into the spring clip fasteners. Tighten the P3 hex nut firmly being careful not to scratch the panel.



A-2-6.

Put the small knob (K1) over the shaft of P3. Tighten it down with the small screwdriver and leave it pointing to "off".



A-2-7.

Turn the tuning shaft (going to the front end) to its extreme counter-clockwise position. Take the plastic dial and insert the small set screw into the proper place in the dial. Mount the dial over the tuner shaft so that the logging scale (the part with the numbers running from 10 to 90) is exactly in the upper half. The front surface of the plastic dial should be just slightly to the rear of the front tip of the outer brass



A-2-8.

dial shaft. It is very important that the dial not scrape against the panel when it is rotated, as it will scratch it. Tighten the set screw, and slowly rotate to check for scraping. Tighten the set screw. Rotate the dial a few times to make sure that it is not rubbing against the front panel. If it is, loosen the set screw and pull the dial slightly away from the panel. Push the large brown knob over the tuning shaft and as close to the dial as it will go without undue forcing. Position the brown knob with the set screw opening on top for ease of installation. Tighten the set screw in this tuning knob.

Insert the tubes into the *proper* tube sockets. The tubes are all clearly marked and the top of the tuner chassis has the tube numbers identified as to location. Place the tube shield over the 6U8 (V3). The tuner is now ready for alignment. Turn the brown tuning knob. If there is any binding between the plastic knob and the dial, remove the knob, and push the dial back slightly. Again, take care to avoid scratching the front panel. Reinstall the tuning knob.

FIGURE 10.

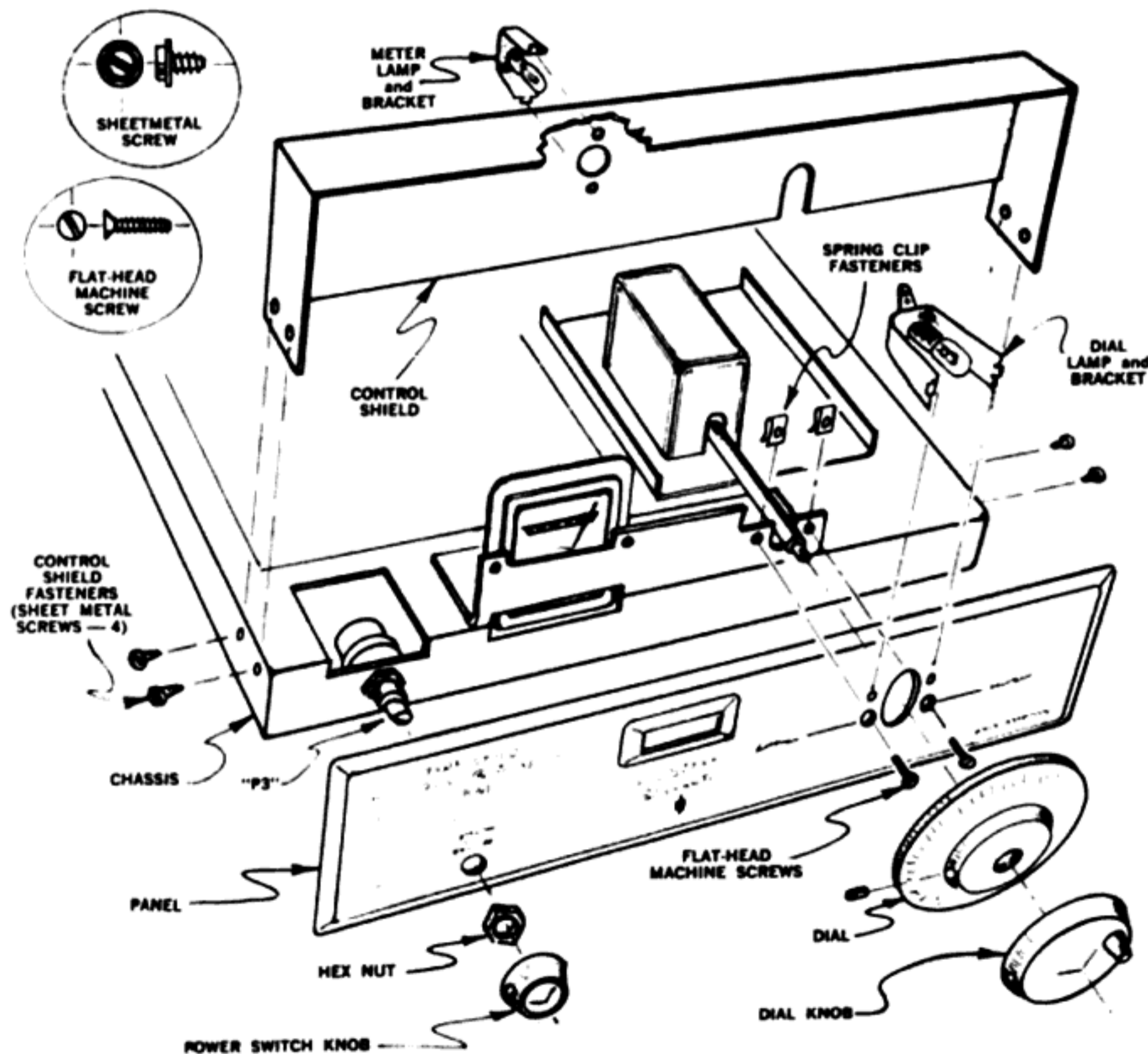

Aligning the Tuner

Two methods are provided for aligning the tuner. One is the unique H. H. Scott EZ-A-LINE® method which eliminates the necessity of using laboratory test equipment, while still insuring top quality results. The second method is the conventional process employing standard laboratory techniques and instrumentation, which is outlined in the Appendix under Service Notes.

For the EZ-A-Line® method the following items are necessary: A special alignment tool, a small screwdriver, an FM dipole antenna, an audio cable with pin plugs on each end, a 10 K (brown-black-orange) resistor, a pilot light, (all provided with the kit), and an amplifier (monophonic or stereo) and speaker.

One end of the alignment tool is for adjusting the IF transformers and the other end is for the detector. See Fig. 11. As part of the detector alignment procedure, a very unique method has been devised whereby a pilot light is employed. To utilize this method, the following preparations are required:

A. Take the pilot light socket with the white wire connected. Insert the light bulb into the socket.

B. Connect the 4 foot wire provided to the end of the white wire. Make a mechanical connection only. Put it aside for use later. Read instructions for each step carefully and completely before proceeding with the step. Check off each step as it is completed. Exercise caution when working underneath the chassis with the tuner on, as high voltages are present. In particular do not touch the wire on the back of P3 (the on-off switch). All operations we specify are safe ones.

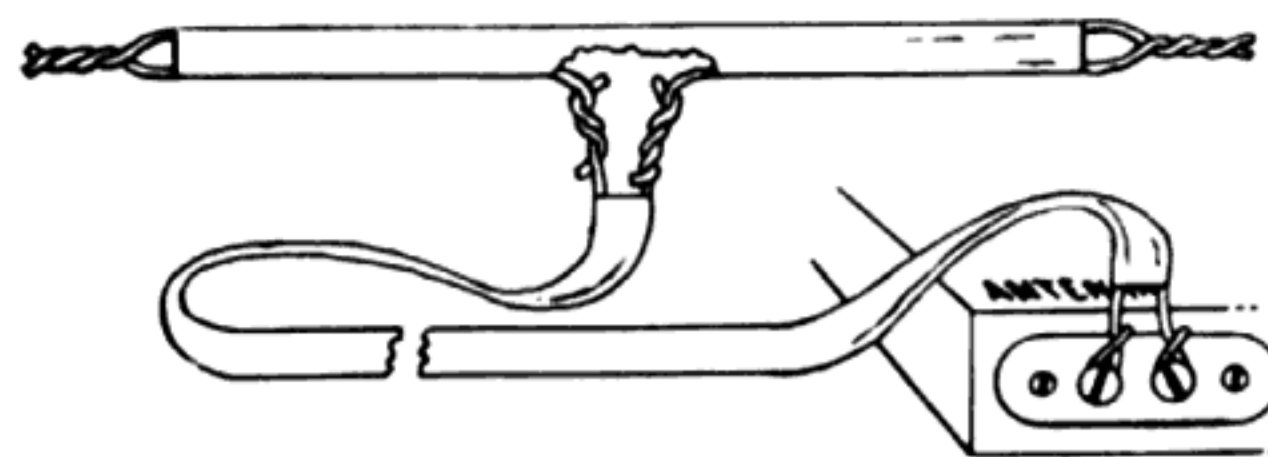

CONNECTION OF FOLDED DIPOLE ANTENNA

FIGURE 13.

1.

Connect the dipole antenna wire supplied to the antenna terminals on the rear of the tuner. Connect one of the leads (see Fig. 13) to the G terminal and the other to the 300 ohm terminal. After the antenna has been screwed on tightly, spread the antenna wire out on the table. Make sure that no part of the antenna wire touches the chassis of the tuner.

2.

Connect the shielded audio cable from the Ch. A output on the rear of the tuner to the tuner-input of the amplifier (amplifier being presently connected to the speaker). For convenience, have the amplifier and the tuner close to each other. Turn the level control on the rear of the tuner chassis to the maximum clockwise position.

3.

Insert the tuner line cord (right behind the transformer), into an AC wall outlet (under no circumstances should it be DC).





4.

Turn the power switch on the front panel of the tuner to "On". Make sure that all the tubes and bulbs light up. Watch for over-heating or smoking under the chassis that would indicate miswiring. (At any sign of trouble turn unit off, and refer to the section entitled, "In Case of Difficulty.")

The meter will probably swing down to a low reading (about "2" or lower). Rotate the tuning dial slowly from one end to the other. Each time a station is tuned in, the meter will move up to a higher number. The amount of meter deflection (e.g. meter swing) will depend on the strength of the station's signal, its distance from you, and how well the tuner is aligned.

A. Normal areas — If you are in an average listening area, you will tune in some strong stations that make the meter move up over "4", and some weak stations that barely manage to wiggle the meter at all. Tune in one of these weak stations, setting the tuning dial so that the meter is at its highest position for that particular station.

B. Strong Signal areas — If you live near the transmitters of the FM stations, you may find that you cannot locate any weak stations at all. Everything you find may cause the meter to swing over "4". In this case you must artificially weaken the signal. To do this, remove one lead from the antenna wire connected to the "300 ohm" terminal. Connect one end of the 10 K ohm resistor (brown-black-orange) to the "300 ohm" terminal, and the other end of the resistor to the lead that was just removed from the terminal. This will bring the meter down to a lower reading.

C. Extreme fringe areas — If you live many miles from any transmitter, *you may find that it is impossible to note even a wiggle on the meter.* Try raising the antenna off the table and taping it to the wall. If that does not help, connect the tuner to the antenna wire coming from an outdoor television antenna. A final approach is to use the amplifier as a guide. Turn the input selector of the amplifier to the "tuner" input. Adjust the volume control of the amplifier so that the sound from the tuner itself can be heard. Turn the tuning knob of the tuner until a station is audible. It will undoubtedly be very distorted, faint, and noisy. Start the alignment procedure at this position. Once meter deflection occurs, readjust the tuning knob so that the meter is at its highest reading for the station. Ignore the sound from then on (in fact, you can turn the volume back down).



5.

Before proceeding, listen to the station you have tuned in over your amplifier and speaker. Make sure that you have tuned in a single station and that there are not two stations coming through at that point. If there are, find another station to use.



6.

Carefully adjust the tuning knob so that the meter is at its highest position for the station tuned in (regardless of how distorted it sounds).

NOTE: The passage overhead of an airplane will cause the meter indicator to swing up and down. Hold up the alignment until this stops.) Set the tuner on its end with the black transformer side down, and the front panel facing you (see fig. 14).

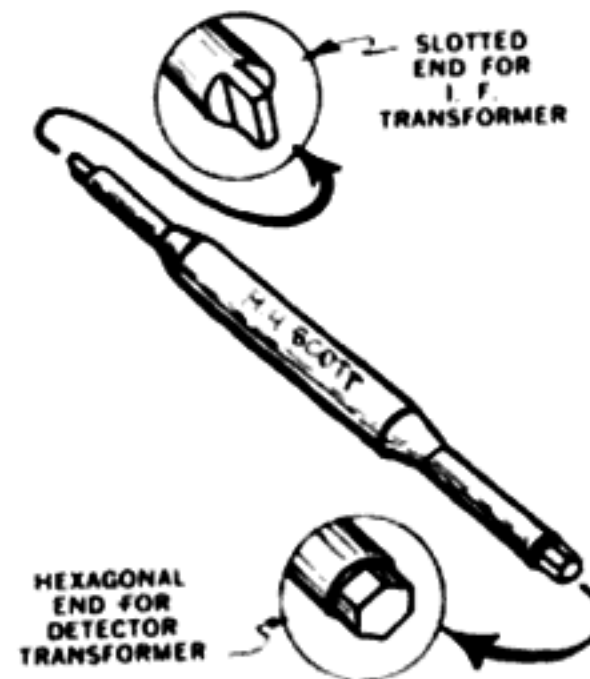

FIGURE 11.



7.

Insert the IF alignment tool (see fig. 11) into the bottom of T2 (underneath the chassis) until the end of the tool makes contact with the tuning slug inside. The slug may be over a half inch inside the transformer. Rotate the tuning slug with the alignment tool while carefully watching the tuning meter for the highest reading. At this time the meter action will be small, so you have to look carefully to insure getting the highest point. You will have to rotate the slug both clockwise and counter-clockwise to locate this maximum position. A scraping noise will be audible as the slug is turned. This is normal. At the extreme clockwise and counter-clockwise position of the slug there is a stop beyond which you should not turn. Do not force beyond this point as this will damage the transformer cans. It is possible for the maximum reading to occur at a stop.



8.

Insert the IF alignment tool into the top (above the chassis) of T2, and rotate for highest reading on the meter.



9.

Carefully readjust the tuning knob to make sure that the station is still tuned to the *maximum reading on the meter.* Insert the IF alignment tool into the bottom of T3 and rotate for maximum meter reading.

Detector Alignment Procedure



10.

Insert the IF alignment tool into the top of T3 and rotate for highest reading on the tuning meter. By now the meter will probably have gone up to a higher reading. If it is over "4" then it would be a good idea to insert the 10 K resistor as indicated in Step 4, B. (Strong Signal Areas). If the resistor is already on the antenna terminal, then it would be a good idea to try and locate a different station on the dial which will have a lower reading.



11.

Carefully readjust the tuning dial slightly to insure you are still getting the highest reading on the meter. Insert the IF alignment tool in the bottom of T1 and rotate for highest reading.



12.

Insert into the top of T1 and rotate for highest reading.



13.

Readjust the tuning dial slightly to insure you are still getting the highest reading on the meter. Repeat the alignment of both the bottom and tops of T2 and T3, carefully watching for maximum reading on the meter. Periodically check to make sure that the station is tuned in properly.



14.

On top of the chassis, on the preassembled front end, are 3 slot headed slugs right next to the shielded case covering the tuning condenser. The *middle* slug is marked "FM RF". Rotate this slug very slightly with the small screwdriver for a maximum reading on the meter. Not more than $\frac{1}{2}$ turn in either direction should be necessary. The meter action will be very small so watch carefully. **DO NOT TOUCH THE OTHER SLUGS.**



15.

If connected, remove the 10 K ohm (brown-black-orange) resistor from the antenna terminal and reconnect the antenna wire as described in step 1.



FIGURE 14.



16.

Insert the *detector* alignment side of the tool (do not use the IF side) into the bottom of T4. Turn the slug counter-clockwise until the stop is reached at the extreme end of its rotation (**be careful because detectors are extremely fragile and any forcing at the end of the rotation will crack them**). Now rotate the slug clockwise exactly $3\frac{1}{2}$ turns. Watch the markings on the detector alignment tool so that you can count off the turns accurately.



17.

Aligning the top of T4 is in many respects the most critical part of the entire alignment procedure. There are two general approaches. Method A is definitely preferred.

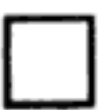

A.

Aligning by Ear — If the balance of your high fidelity system includes a better than average amplifier and speaker system, and if your ear is capable of discerning good, clean reproduction, then you should have no difficulty aligning by ear. Set your amplifier for normal room listening level and locate a station with a good strong signal on the LT-10. Make sure the meter reading is at its highest point. Insert the detector alignment tool into the top of T4 and rotate from one end to the other. You will immediately observe that the sound gets louder and softer a few times. The proper spot to set the slug to is the loud position where the sound is cleanest and the background noise is the lowest.

There is a very simple method of checking to see if you have the correct loud spot. The meter should be at its highest position when the program material from the station is loudest. If you find that the program material gets much louder as the meter swings down from the highest position (even though it gets more distorted, too) then you have the wrong loud spot. You should readjust the top of T4 for a different loud point until you get the correct one.



B.

The light bulb method — an alternate method which some people will prefer is to substitute a light bulb for your "ears." In this procedure you utilize the pilot light socket with the four foot lead that you prepared previously. Only use this method if it is impossible to obtain satisfaction with Method A. In many cases aligning by ear does give more accurate results.

Turn down the volume on your amplifier. Disconnect the speaker leads from the speaker terminal on the rear of the amplifier. (Note: Some people may question the safety of operating an amplifier without a speaker load. All H. H. Scott amplifiers are completely stable so can be operated safely without a load. If you are using amplifiers of other manufacturers and you are not sure of their stability, leave the speaker connected and simply connect the pilot light socket over the speaker wire).

Splice one end of the 4' wire to the wire coming from the pilot light socket; then connect the 4' wire to the 16 ohm terminal on your amplifier. If your amplifier has over 25 watts of output, you may want to connect to either the 8 ohm or 4 ohm terminal to avoid the possibility of burning out the light bulb. If you find you cannot get the bulb to light up at these lower impedances, then reconnect to 16 ohms.

Take the pilot light socket and squeeze it in between the shield of the front end tuning condenser and one of the IF transformer cans as shown in fig. 12. Turn the amplifier treble control to maximum (extreme clockwise) and the bass control to minimum (extreme counter clockwise).

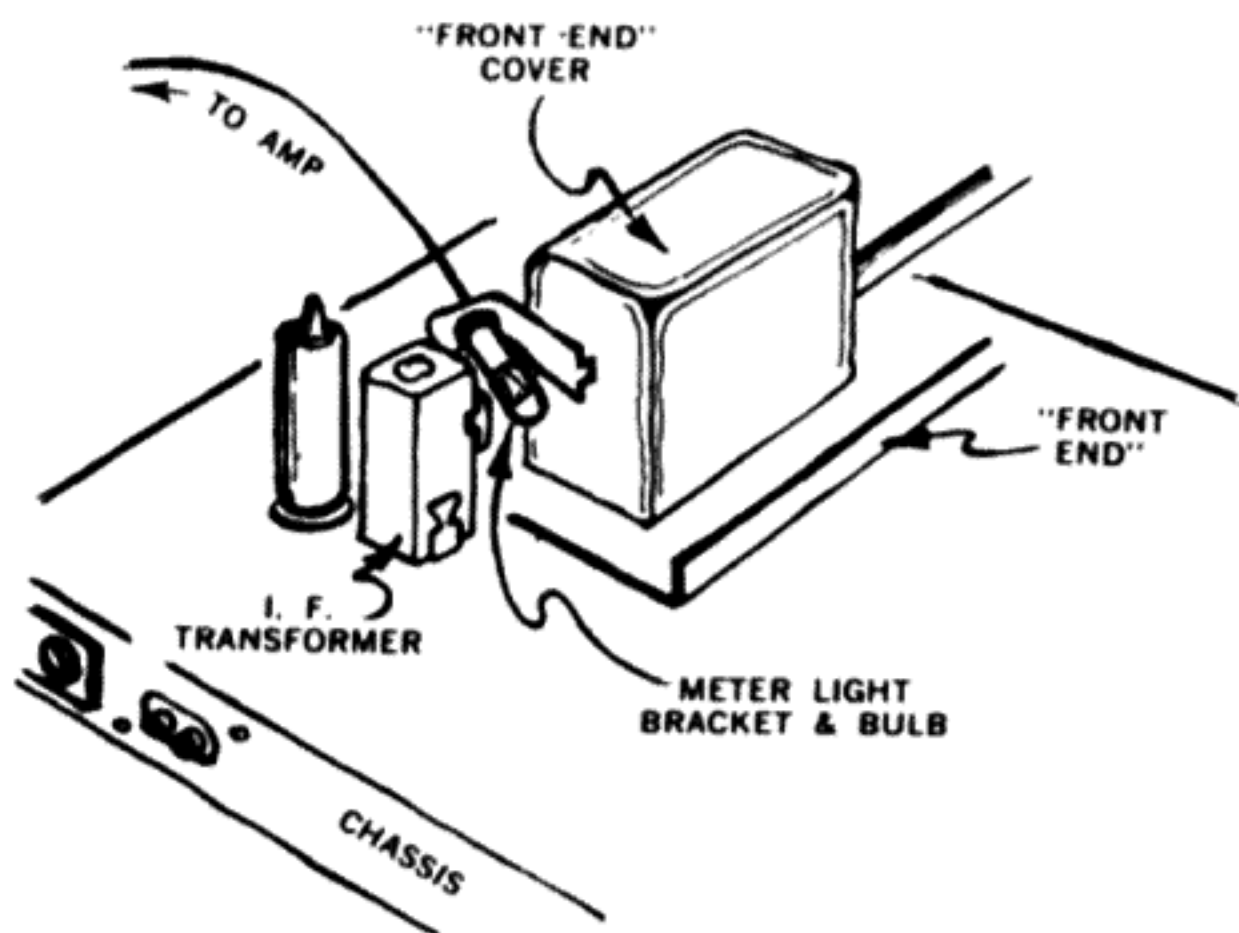
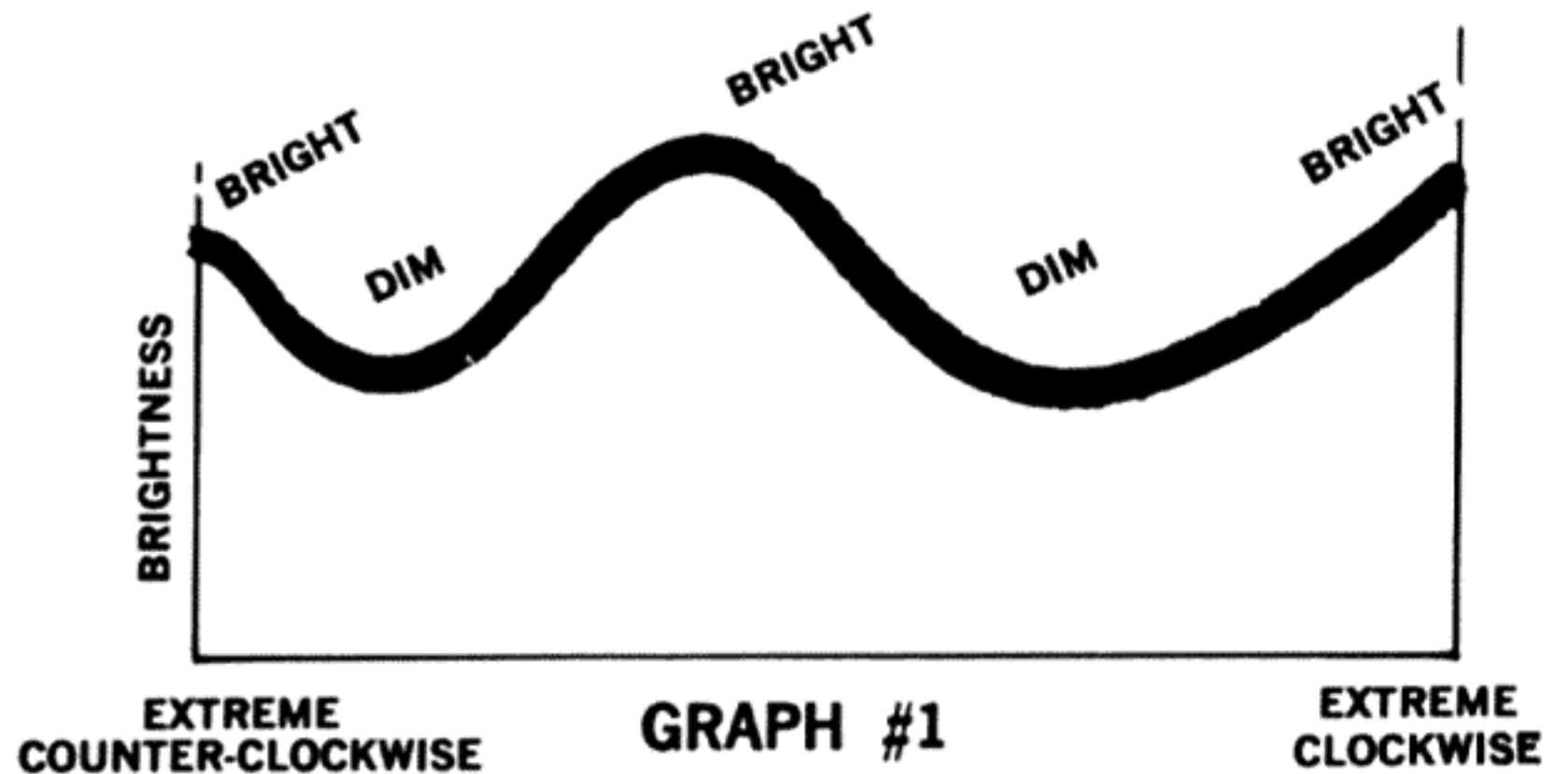

FIGURE 12



18.

Turn the tuning dial to the lowest point on the dial (below 88 mc). Make sure that you are not picking up a station at this point. Retune off any station. Insert the detector alignment tool into the top of T4. Rotate the slug counter clockwise until the stop is reached at the extreme end of the rotation. Be careful as detectors are fairly fragile. Turn up the volume on the amplifier until the pilot light begins to glow dimly. Rotate the slug clockwise. You will observe that the bulb gets brighter and dimmer in succession until you reach the stop at the opposite end. (Be careful that you do not burn out the bulb by having too much volume from your amplifier.) The effect will be similar to that depicted in Graph 1.



Stop tuning at the bright spot in the middle. It is worth noting that the difference in brightness between the various high points may be quite great. Nevertheless, if the effect is similar to Graph 1, stop at the middle peak.

Frequently, the detector will exhibit only two bright points, such as in Graph 2.

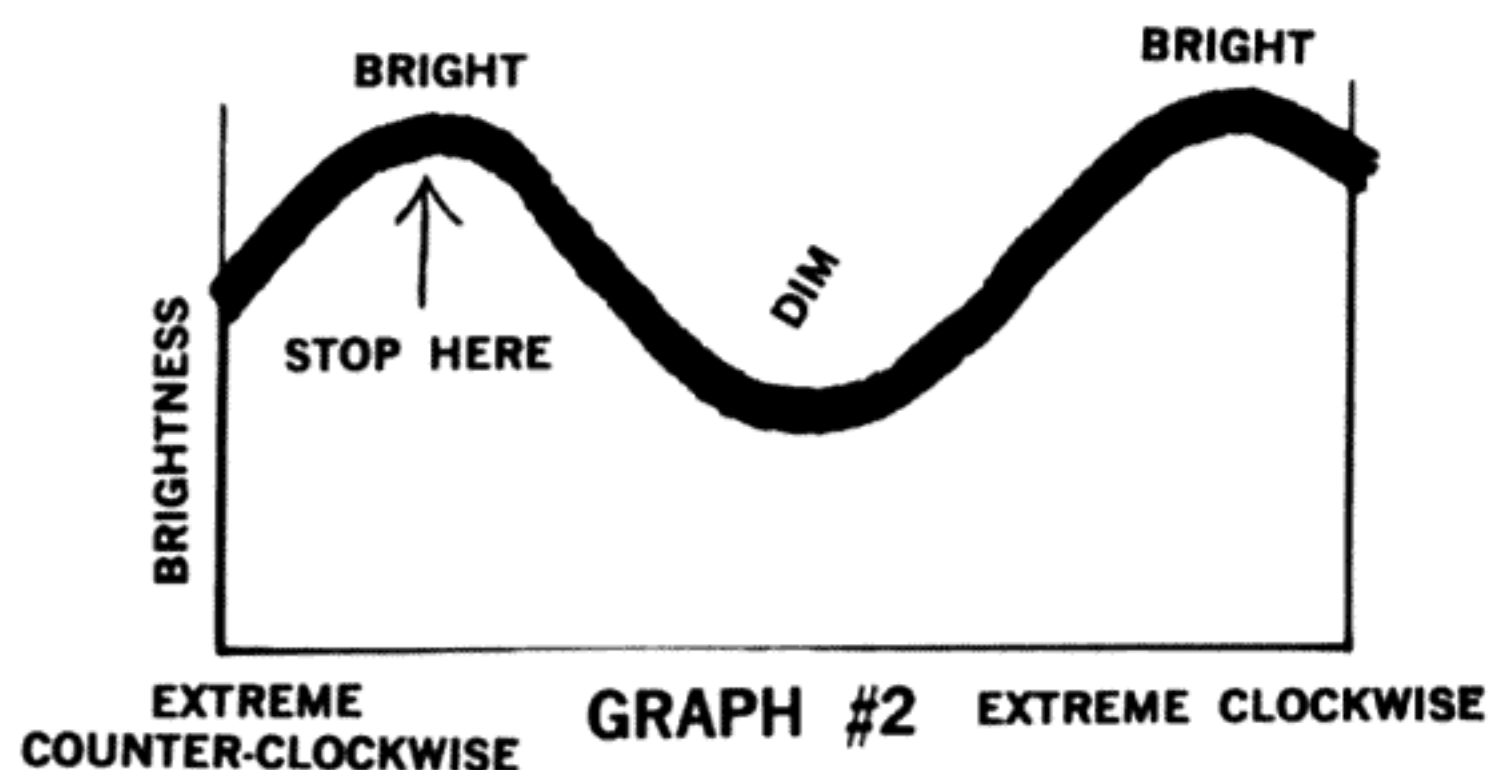

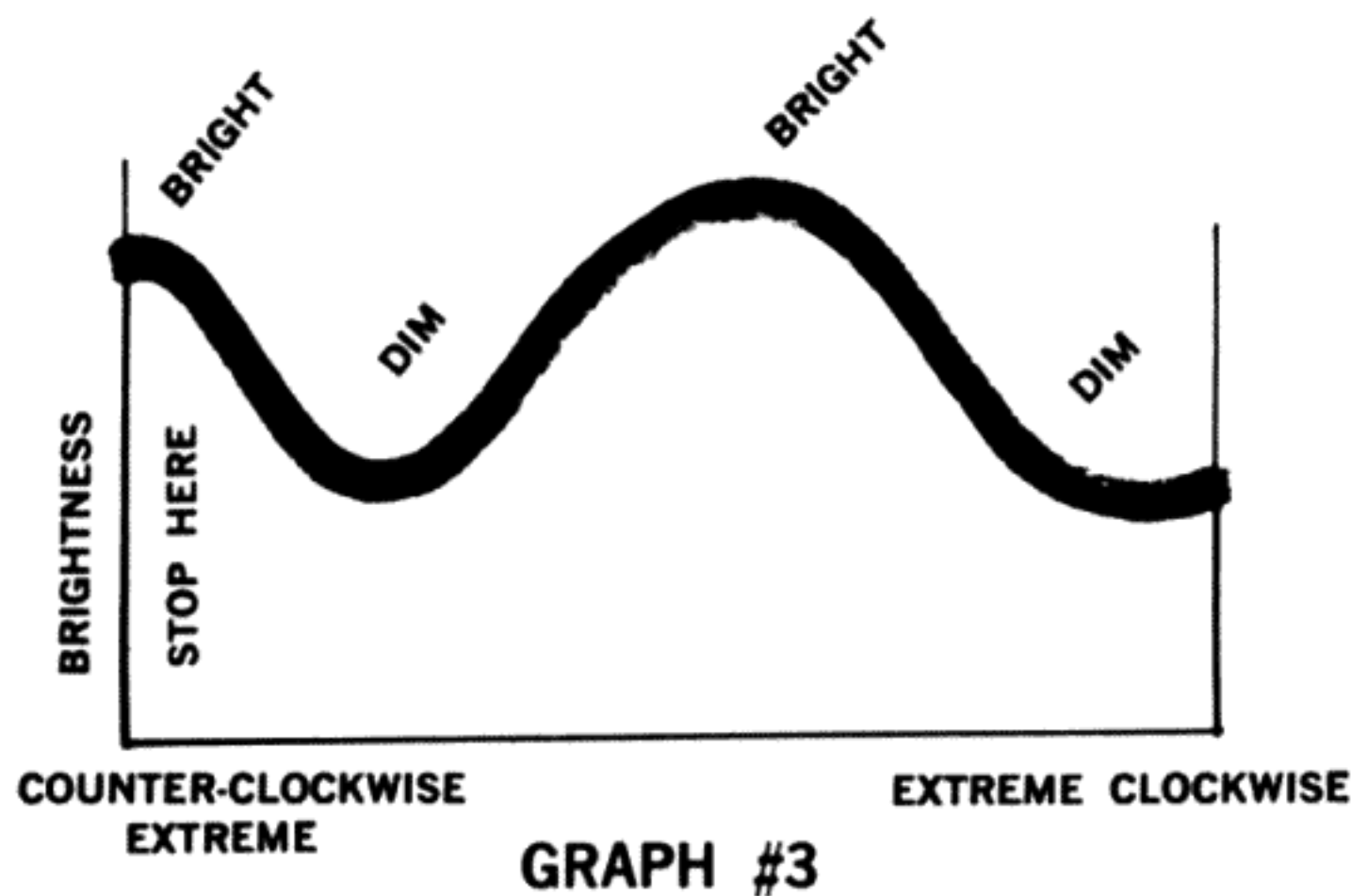

The one to select is the first one you come to going from extreme counter-clockwise to extreme clockwise. In some cases, the first bright spot will be right at the extreme counter-clockwise position as shown in Graph 3. This is where you should leave it.

The graphs are only guides as to what you can expect. A little careful looking will undoubtedly indicate how many bright spots you have and which of these graphs comes closest. Due to differences in construction skill from one builder to the next, it is difficult to predict the exact curve that you will obtain.

The final criterion is in the listening. Disconnect the light bulb wire from the amplifier. Reset the tone controls to their normal positions. The program material should be loudest when the tuning meter is at its highest position for that station. If the program material gets louder (even though it is distorted) when the meter drops down to a lower position, then you have not selected the proper place. Repeat this step.

Hints for Aligning T4 if you continue to have difficulty.

1. Go over the alignment for T2 and T3 on a very weak signal to make sure that they are at the maximum.
2. Align the *bottom* of T4 by rotating for maximum brightness on the pilot light bulb rather than setting for 3½ clockwise turns.
3. Turn the tuning dial to the highest point (above 108 mc) again making certain that no station is tuned in, and repeat the light bulb test.
4. If all this fails, adjust the top of T4 by ear as described before.

19.

You should now reset the tuning dial so that stations are received at their proper location on the dial. Select an

FM station of known frequency in the center of the dial (between 96 and 100 mc.). You can check your newspaper's radio section for this information. Remove the tuning knob. Loosen the set screw on the dial and carefully turn to the correct frequency for the station tuned in. Tighten the set screw (do not let the dial get too close to the panel) and replace the tuning knob.

Final Assembly PART II

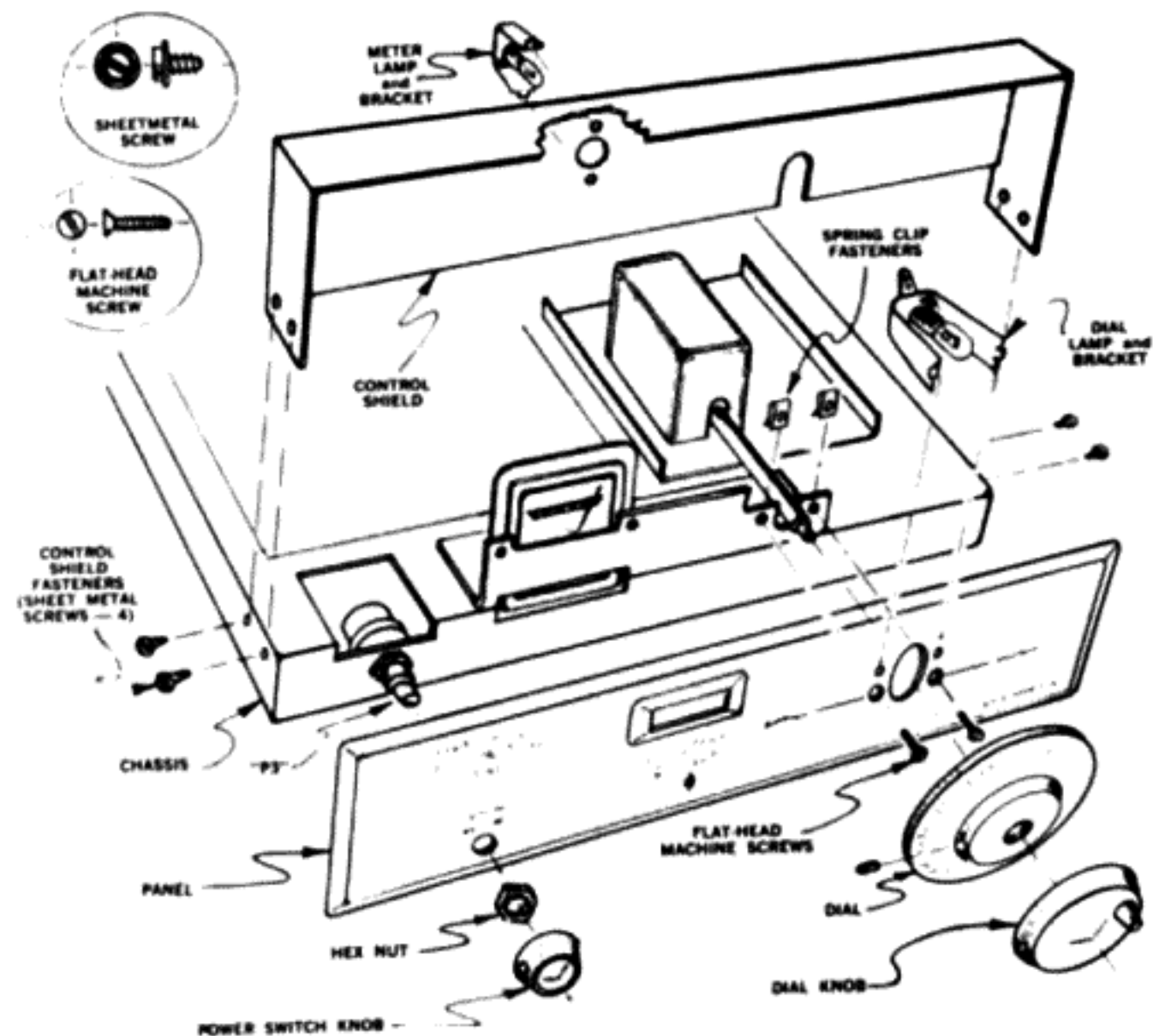

FIGURE 10.

A-3-1.

See Fig. 10 for all the following steps. Unclip the pilot light socket from the cutout in the back of the meter. Snap the socket into the two small holes in the back of the front panel right behind the tuning knob.

A-3-2.

Remove the other pilot light socket from the two foot grey lead used in the alignment process. Insert the end of the white wire coming from the socket into the remaining hole on the back of the pilot light socket behind the tuning knob. Solder this lead. Be careful of a short circuit to the body of the pilot light socket. Position the white wire along the chassis.

A-3-3.

Take the large metal control shield and insert the remaining rubber grommet into the hole on the shield.



A-3-4.

Mount the control shield on to the front portion of the chassis, right behind the front panel, by installing the four 1/4" sheet metal screws through the holes in the bottom sides of the shield and into the chassis. Sheet metal screws require some force to insert properly. Snap the pilot light socket into the holes provided for it behind the meter in the control shield.



A-3-5.

Turn the unit over. To mount the bottom cover slide the 2 spring clips on the bottom cover under the chassis lip, towards the front of the tuner. Screw the two small sheet metal screws into the 2 inside holes on the bottom rear of the chassis.



A-3-6.

If the tuner is not going to be used in one of the regular H. H. Scott metal or wooden cases, you will want to install the rubber feet now. These will be found in one of the small envelopes, entitled ZP-5. Mount the four rubber feet with the four sheet metal screws provided.

If the tuner is to be custom mounted in a cabinet, instructions for doing this are on the mounting template provided. Envelope ZP-5 includes the parts you will need.

Congratulations!

Now . . . sign your personal label "This kit was built by ____" . . . turn your tuner on . . . relax . . . and listen to one of the finest FM tuners ever made.

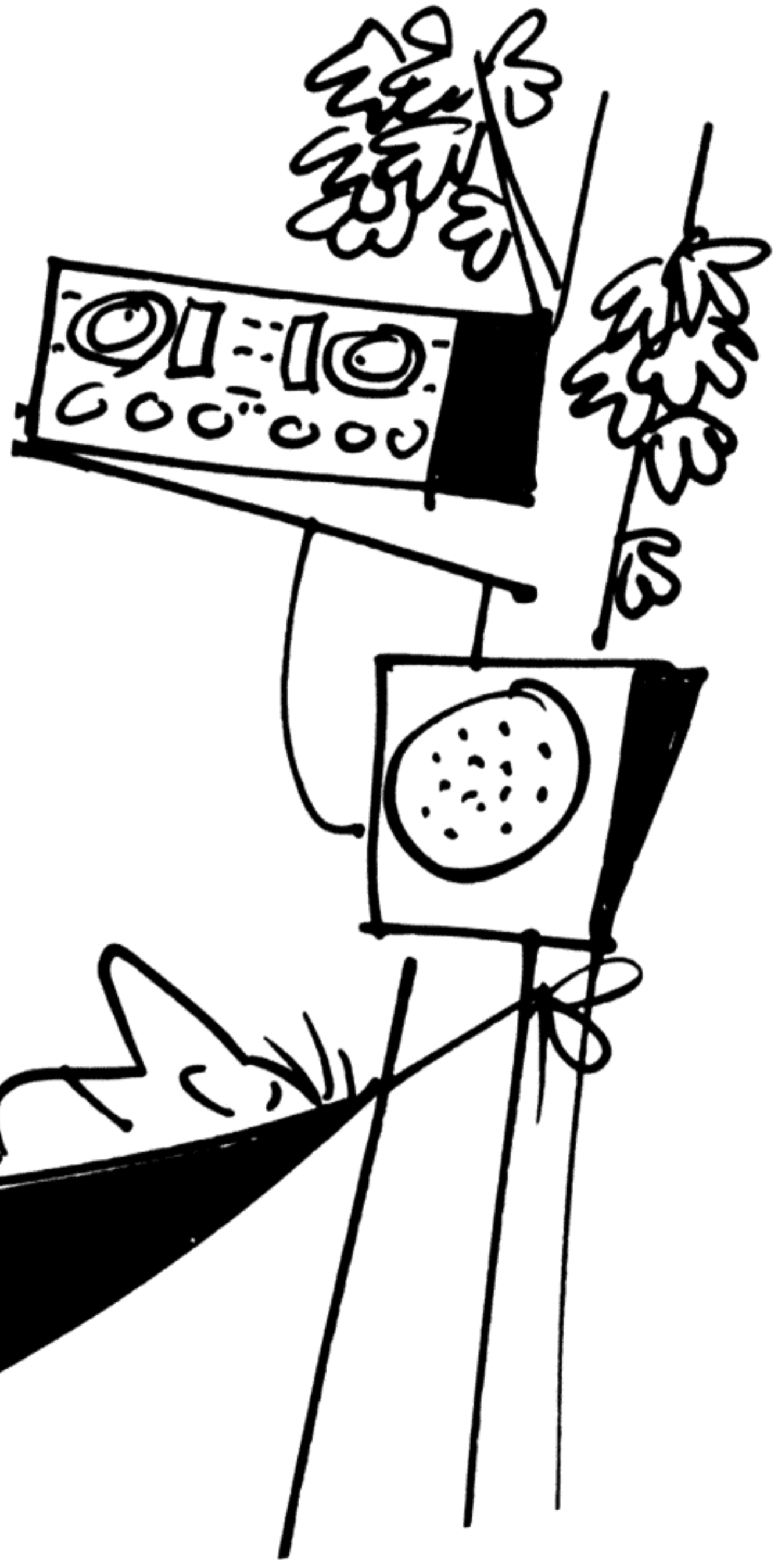

In Case of Difficulty

No matter how careful you are, a mistake is possible. Don't panic! First, make sure each tube is in the proper location. Then go back to the assembly notes and check off each step with the written instructions and the pictorials. Or if possible, have someone else do this for you. Often a fresh approach may disclose mistakes that you might be consistently overlooking. While checking for errors, carefully probe each and every wire, lead, component, and part to make sure there are no short circuits and poor solder joints.

In case the fuse has blown (the unit will not light up) it is very likely that there is a short circuit. Before replacing the fuse (instructions for this will be found in the service notes in the appendix) search for the cause.

In case the unit lights up but does not operate properly voltage readings are supplied on the schematic. If you can obtain a good vacuum tube voltmeter (VTVM) use the voltage readings for locating the portion of the circuit that is malfunctioning.

If none of the above suggestions help in curing the problem you should write to our Laboratory Kit Service Dept. for prompt assistance. There is no charge for this help. The engineers in this department are thoroughly familiar with all aspects of the kit, and can probably localize the cause of your difficulty. However, you must be very explicit in describing your problem. Mention all the approaches you have undertaken to cure it. Describe all the symptoms and signs that may be involved. With complete information supplied, the possibilities of a cure through the mail are greatly increased.

Service

When all else fails the facilities of the H. H. Scott Laboratory Kit Service Department and the vast network of Authorized Warranty Service Stations are available to you. You will be charged a fixed fee of \$10.00 for each unit that is submitted either to the factory or to a Warranty Station within the warranty period. This fee will be in addition to any parts that have to be replaced. If the unit is still within the 90 day warranty period (see description of the Warranty Policy below), then the charge for parts will be

governed by this policy. A list of warranty service stations is included with this kit.

Many H. H. Scott dealers have service facilities and are fully competent to repair this kit. These dealers are not governed by our price policy and can charge any fee they wish. This fee should be ascertained before service is begun.

The service policies described above only apply to completely assembled instruments constructed according to the instructions supplied. Any unit that is not complete, or has been modified in any way will not be accepted. Instruments showing the use of fluxes and acid core solder will also not be accepted.

Warranty

To protect your investment, H. H. Scott, Inc. warrants that for a period of three months from the date of purchase, all parts shall be free of defects in materials and workmanship under normal use and service. H. H. Scott, Inc. will replace any defective parts upon the return of same to the factory, either by the customer, the dealer, or a warranty service station. There will be no charge for this replacement.

This warranty does not apply to any parts damaged during the course of handling and assembling the kit. No other warranty, either expressed or implied, shall apply to this unit.

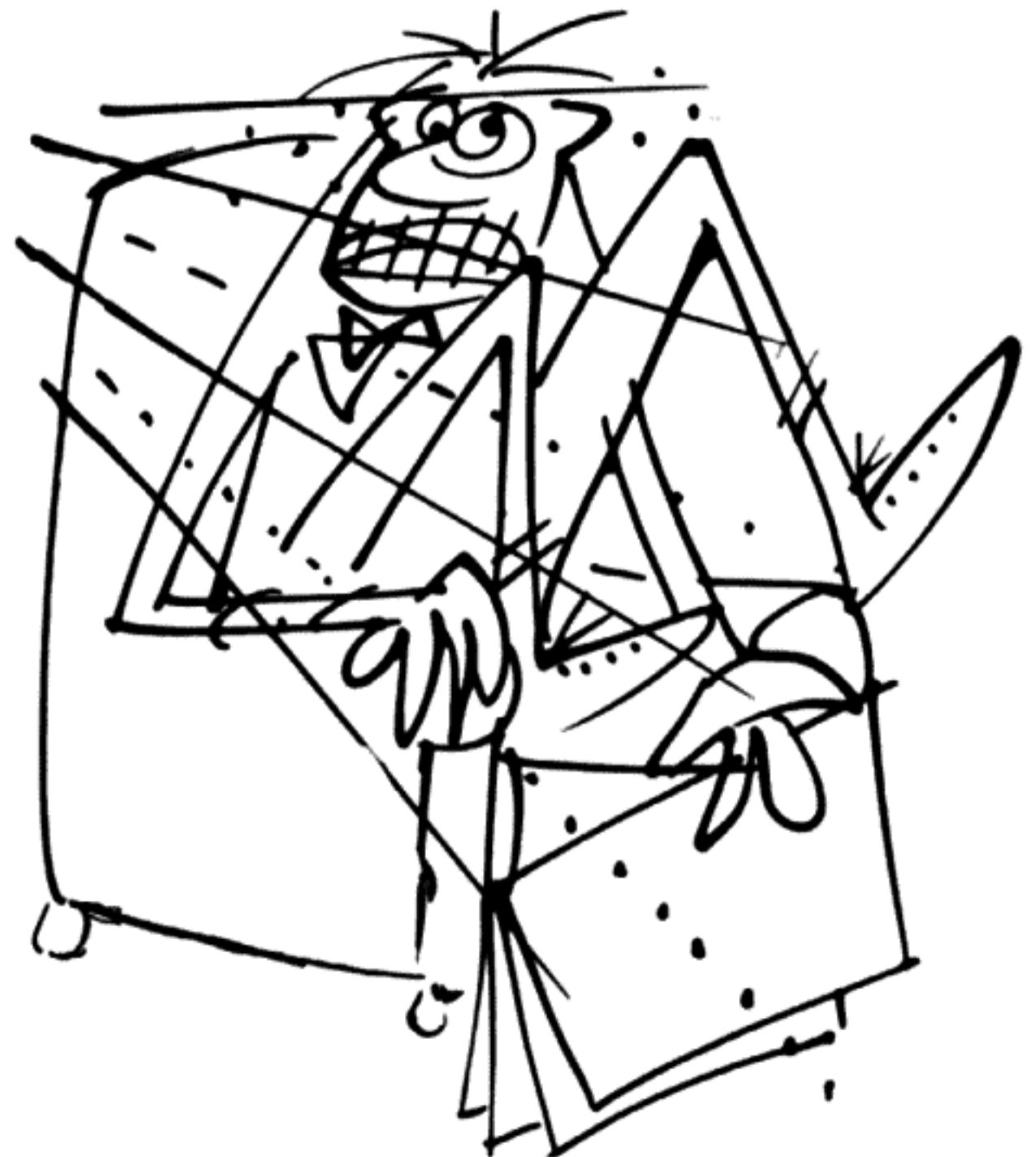



Service Hints for Model LT-10 Wideband FM Tuner

IHFM SPECIFICATIONS

(These are minimum—all H. H. Scott Model LT-10 tuners should meet or *exceed* these figures if all instructions have been followed properly.)

Usable Sensitivity (IHFM) (For less than 3% total noise, distortion, hum -30 db.)	2.5 microvolts
Signal to Noise Ratio	60 db. below 100% modulation
Total Harmonic Distortion	0.8%
Frequency Deviation	0.02%
Frequency Response	20 to 20,000 cps ± 1 db.
Capture Ratio	6.0 db.
Selectivity	35 db.
Spurious Response Rejection	80 db.
I.M. Distortion (CCIF method)	0.3%
Hum	66 db. below 1 volt
AM Suppression	55 db.
Audio Output (100% modulation)	0.8 to 1.2 volts
Tuning Range	87 to 109 mc.
Accuracy of calibration	0.5%
Output Impedance	3000 ohms
Minimum Recommended Load Resistance	100,000 ohms
Maximum Recommended Cable Capacitance	1000 mmfds
Maximum Recommended Length of Output Cable	70 feet
Range of Line Voltage and Frequency	105-125 volt/50-60 cps.
Power Consumption — AC only —	38 watts

DO NOT OPERATE WITH DIRECT CURRENT.

GENERAL SERVICE NOTES

Service, other than replacement of either pilot lights or vacuum tubes is usually not required. If the tuner is not operating properly, all external connections should be checked to make sure that the difficulty is in the tuner. Generally, it is advisable to replace the connection to the tuner with a tape recorder or similar device to check out the amplifier performance. If the difficulty appears to be located in the tuner, the level control should be first checked to insure that it is rotated away from its extreme counter-clockwise position. Then, the vacuum tubes should be checked by replacing them with new ones, one by one. The tubes should be tight in their sockets and provided with shields where applicable. Tube defects frequently do not show up in a tube tester. Only operation in the tuner will insure the proper working of a vacuum tube.

Replacing the fuse

An M-DV- $\frac{1}{2}$ amp fuse is wired into the circuit. To replace this fuse, unsolder the fuse lead connected to pin 1, S4 and to pin 2, S4. Solder two short pieces of buss (uninsulated) wire to the ends of the replacement fuse. Trim these to length and connect to pin 1, S4(S) and pin 2, S4(S). Make sure that no part of the fuse or the uninsulated leads from the fuse touches either the chassis or any other bare wires.

Hum Adjust

Slight improvements in hum can be made by rotating this control for minimum output with level control on back of tuner in extreme counter-clockwise position.

LABORATORY ALIGNMENT INSTRUCTIONS

1. Equipment required: VTVM (AC), FM Signal Generator (must be of high quality), Oscilloscope, 400 cps null, and insulated alignment tools.
2. Equipment set-up: Connect signal generator directly to the 300 ohm antenna input of the tuner using a matching impedance network if necessary. The audio output of the LT-10 then feeds into the 400 cps null and from the null to the oscilloscope and VTVM in parallel. If no null is available (a schematic for making one of these very simple and useful devices is available from the Engineering Dept.) the tuner can still be serviced. However, it will not be possible to measure the tuner's "Usable Sensitivity" as per IHFM standards, or align the detector.
3. Allow tuner and test equipment to warm up fully before beginning alignment. Adjust line voltage for 117 volts. Remove bottom cover of tuner. Always tune primary and secondary of I.F. transformers at the same time, using one alignment tool in each hand.
4. Set generator and tuner for 92 mc. Generator should be modulating a 400 cps signal at 75 kc deviation. Adjust output of generator so that a barely adequate sine wave appears on the scope (on the order of 3 to 6 microvolts input

to tuner). The null filter should be switched out of the setup, so the tuner is feeding directly to the VTVM and scope. Peak the IF's and the primary of the ratio detector (the bottom slug) for maximum reading on the VTVM.

5. Adjust the secondary of the ratio detector (top slug) for maximum reading on VTVM and cleanest response on the scope. There will be more than one maximum point, but only one will be clean on the scope.
6. Adjust antenna coil for maximum output. Tune generator and tuner to 106 mc. with same output and deviation, and adjust antenna trimmers for maximum output. Repeat this operation until best results are obtained.
7. If calibration is off, repeat "6" except adjust oscillator coils for correct tracking at 92 mc. and oscillator trimmer for correct tracking at 106 mc.

MISCELLANEOUS SERVICE PROCEDURES AND TESTS

NOTE: Replace bottom plate before testing.

1. Test for IHFM Usable Sensitivity measurements: Use 117 volt regulated line, set generator and tuner at 92 mc. with 6 microvolt input. Take a reference reading on the db. scale and check for 34 db. or more reduction in output with 400 cycle null filter switched in to setup. Repeat at 106 mc. If specification is not met, tuner should be realigned and tubes checked. It is very important that the null filter be carefully adjusted so that it is at exactly the same frequency as the 400 cps modulation being fed in. Otherwise, it will be impossible to obtain stated sensitivity figure. Note that 6 microvolt output of generator is equivalent to less than 3 microvolt on tuner input due to drop through the matching impedance network.
2. Audio output: With 1000 microvolt input, 75 kc deviation, maximum output should be 1.2 volts.
3. Automatic Gain Control: The maximum permissible difference in output between an input of 6 microvolts and 1000 microvolts is 8 db.
4. F.M. Hum: At 100 mc., 1000 microvolts input, 400 cycle modulation, take a reference reading and remove modulation. A 50 db drop should be noted. Have level control at maximum. With level control at minimum a drop of 70 db can be noted.
5. A.C. Hum: As above but with no modulation and level control at minimum. Hum should not exceed .002 volts.
6. Oscillation Check: Check entire FM band for oscillation, with and without antenna, at 105 and 130 volt line.

If any of the above tests are not met, then the unit should be carefully tested for alignment, tube weakness, or component failure.

Important:

Unless proper precision test and service equipment is used, it will be impossible to properly service or test the tuner.

Packing for Shipping

If it becomes necessary to return the instrument to the factory, it is possible to use your Kit-Pak container for shipping. Remove the die cut platform (the large piece of white cardboard in the bottom of the box that held all the parts). Place the tuner into the box so that it fits into the long slot in the die cut pad underneath the platform. Remove the knobs and dial from the tuner. Put them into an envelope and pack them with the unit. Tie a shipping tag to the tuner with your name, address, and a complete list of the problems involved. Place the white die cut platform back over the tuner. Cut the rectangular section out of the white chimney piece that was originally used to hold the tuner down. Place this section over the tubes (do not remove the tubes). Fill the rest of the box with crumpled newspaper so that the tuner does not move around. Close and seal the box with strong tape or a heavy cord. Insure for its full value and

Ship by railway express prepaid to:

**Laboratory
Kit Service Dept.
H. H. Scott, Inc.
111 Powder Mill Road
Maynard, Mass.**

Installation

The LT-10 can be placed on a table or bookshelf, in existing furniture like an end-table, buffet, or room divider, or in a specially designed equipment cabinet. A handsome hand rubbed wood accessory case is available from your dealer.

Wherever the LT-10 is placed, adequate provision should be made for ventilation. If this is not done, drift will occur and the life of the internal components will be appreciably shortened. By adequate ventilation we mean some space above and behind the unit where air may circulate freely, or, if it is installed in a cabinet, an open back. Always remember that this model draws about 100 watts of electricity and if you placed a 100 watt bulb in a cabinet, you would need a fair amount of moving air to keep it from getting too warm. If mounted with an amplifier, place the LT-10 alongside or below, never directly above the amplifier where it would come into contact with warm air heated by the amplifier's output tubes.

Connections

POWER

The power cord should be plugged into any 105 to 125 volt, 50 to 60 cycle, AC source. Do not attempt to use with DC. If the amplifier has an auxiliary power outlet, you should use it.

ANTENNA

An FM dipole antenna is supplied with the unit. In most strong signal areas this should be more than adequate to pull in all the FM stations available. Antenna connections are made to the terminal strip marked "Antenna" located on the back panel. The dipole leads are connected to the screws marked 'G' and 'FM 300 ohm' respectively. The dipole should then be opened to a full "T" shape. To position the antenna, tune in a fairly weak station. The meter will read highest when the signal is at its best. Keep rotating the antenna until the signal is strongest.

In fringe areas (or even some nearby areas with interference problems) an external antenna may be necessary. This can be either a standard FM antenna or a presently existing TV antenna. If the TV antenna is used, make certain that it is not one of those designed to avoid the FM band; these will obviously not give satisfactory results. Also a double-pole, double-throw switch should be incorporated in some accessible place so that the TV antenna can be switched either to the

television or the LT-10. Both the LT-10 and a TV set should not be in operation at the same time on the same antenna.

In areas of extremely high noise, such as a busy highway, the following system is suggested:

Mount a yagi antenna (either single or stacked) at some point as far removed from the source of the disturbance as possible. Connect a 300 ohm to 72 ohm transformer on the mast, and run 72 ohm shielded antenna lead-in wire to the tuner. The lead-in should not be more than 50 feet in length, if possible. Since the yagi antenna is extremely directional, it is important that it be positioned for the best reception of desired stations. In areas where stations are available in diverse directions, an antenna rotator is suggested.

CONNECTIONS TO YOUR AMPLIFIER

The LT-10 has two identical outputs for making audio connections. If the LT-10 is being used with a monophonic amplifier, connect a shielded cable from the Channel A audio output to the tuner input of the amplifier. If the LT-10 is used in conjunction with a stereophonic amplifier, connect a cable from the Channel A output to the Channel A tuner input of the amplifier. Also, for operating convenience you may connect an additional cable from the Channel B output to the Channel B tuner input of the amplifier. This will permit you to leave your stereophonic amplifier set to the Stereo position when operating the FM tuner. In all cases, cable length should not be greater than 75 feet.

CONNECTIONS TO A TAPE RECORDER

If your amplifier does not have a tape recorder output, the Channel B tape output of the LT-10 can be used to supply a signal to the recorder. A shielded cable should be used to connect to the tuner input of the recorder.

CONNECTIONS TO A MULTIPLEX ADAPTOR

Multiplexing is a method of broadcasting more than one signal over a single transmitter. It makes it possible for an FM station to carry both channels of a stereo broadcast.

The LT-10 is readily adaptable to stereo multiplex reception, because it, like all H. H. Scott tuners, has the necessary frequency response (to 75 kc), the necessary signal to noise ratio (over 60 db), and the extremely low distortion required for satisfactory results. H. H. Scott has a multiplex adaptor for use with your tuner. Your dealer can supply it with a front panel to match the LT-10.

Description and use of Controls

ON-OFF SWITCH

Rotation of this control clockwise will turn the tuner on.

TUNING AND STATION SELECTOR

The exclusive H. H. Scott rotary tuning dial is extremely easy to use and read. It permits you to select the desired station quickly. A logging scale is provided for locating stations that are close together. As the tuning dial is rigidly attached to the shaft of the tuning condenser, accurate calibration will be maintained indefinitely.

TUNING METER

The tuning meter shows the relative strength of the incoming signal. To tune a station, rotate the dial until the meter reads a maximum and the signal sounds cleanest. The maximum meter reading will vary from station to station depending on signal strength.

The meter was designed for sensitive action, and it will indicate great differences in level for minute variations in signal strength. Often the same station may produce a different maximum reading on different days. This only indicates minor variations due either to atmospheric conditions or changes in the FM station's transmitter.

LEVEL CONTROL

The level control is located on the back of LT-10. This should be set once and not altered thereafter as the extremely well designed automatic gain circuit of the LT-10 will permit you to tune in strong as well as weak stations without having to readjust the volume. The level control should be so set that switching your amplifier between the record player and the LT-10 does not change the relative volume drastically. On H. H. Scott amplifiers the loudness control should be between 3 and 6 for normal listening levels.

Choosing your Amplifier

Your new FM tuner is the finest tuner kit on today's market. It is designed with the precision that has made the name H. H. Scott a synonym for quality in the component field.

But a fine high fidelity system is only as good as its weakest link. Therefore we suggest that you invest in an H. H. Scott stereo amplifier when you are ready to expand your present system.

All H. H. Scott amplifiers are a perfect match to your new LT-10 both in appearance and performance. Where an amplifier has knobs of different finish from your LT-10, an accessory knob kit is available for your tuner.

H·H·Scott . . .

a history of leadership in the Acoustic field

To insure that every H. H. Scott component meets the highest standards of quality, H. H. Scott maintains this ultra modern plant for the design and manufacture of all its components.

This new plant, located in Maynard, Massachusetts, includes a machine shop, sheet metal facilities, coil and transformer department, electrical assembly department and fully equipped laboratories for design and research.

The engineering department is staffed by 12 graduate engineers who are primarily concerned with developing new and better components for high fidelity sound.

Every high fidelity component receives over 50 electrical and mechanical tests before it leaves the factory. Special electrically shielded "screen rooms" are used for aligning FM tuners. There are life test facilities where components are run for thousands of hours under strict controls to test their durability.

These extensive investments in facilities back up H. H. Scott's philosophy that there will never be any compromise with quality.

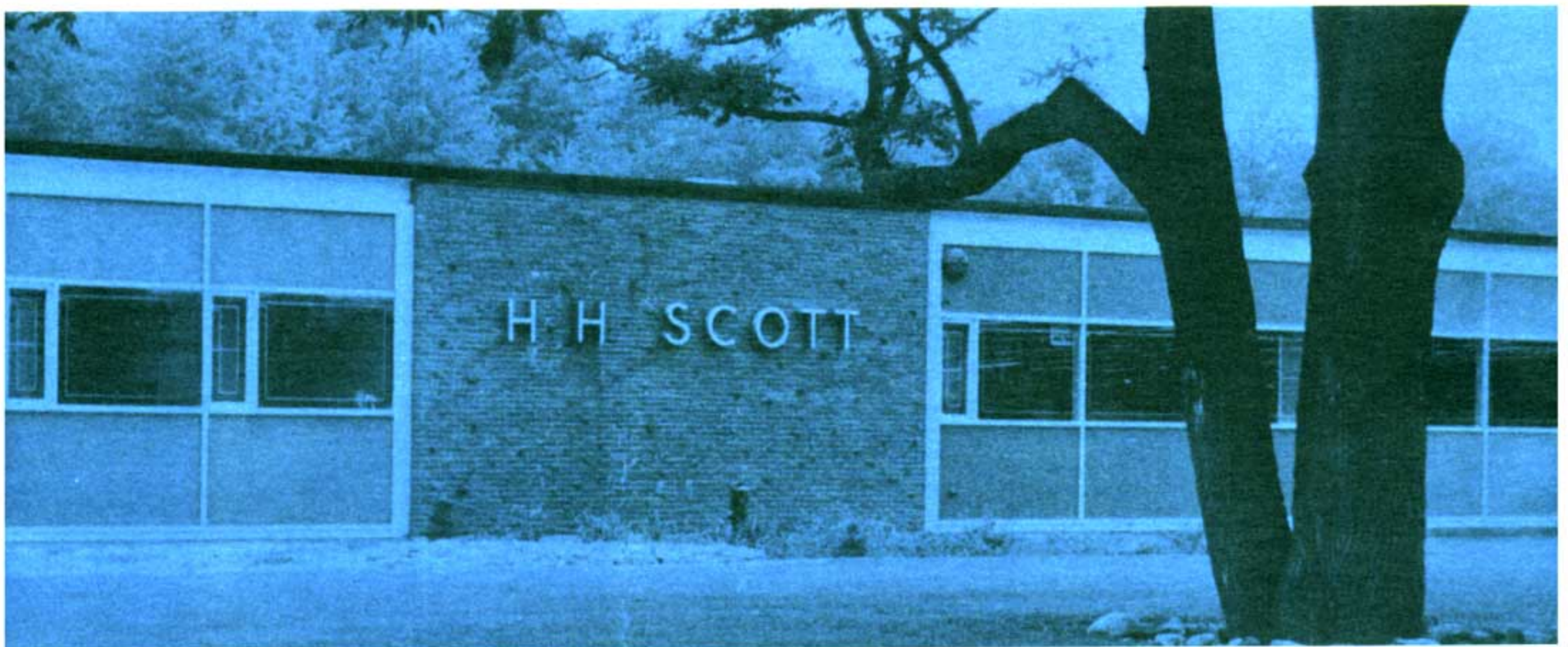

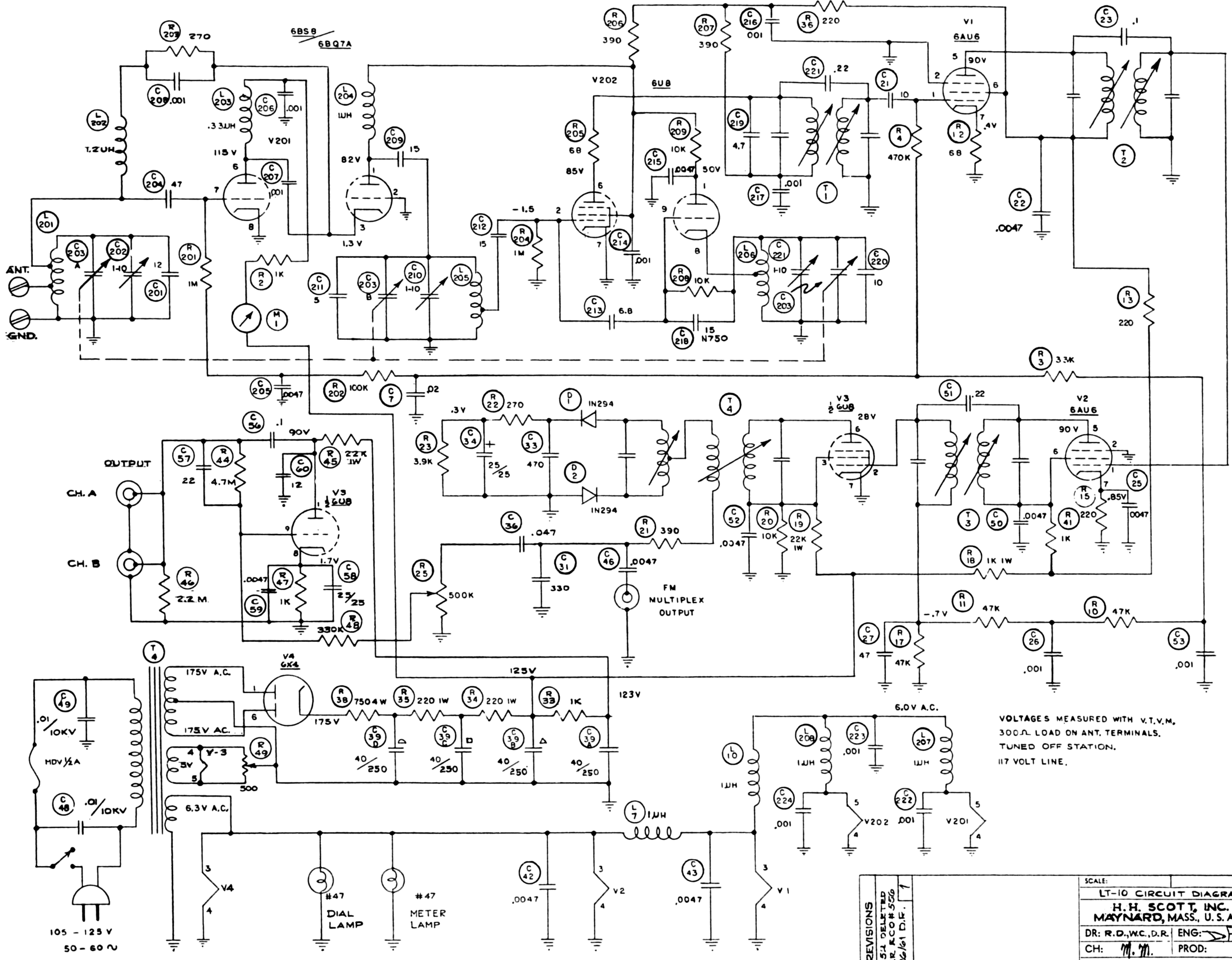

VOLTAGES MEASURED WITH V.T.V.M.,
 300Ω LOAD ON ANT. TERMINALS,
 TUNED OFF STATION,
 117 VOLT LINE.

REVISIONS
 C-51 DELETED
 PER A.C.O.#550
 1/26/61 D.R. 7

SCALE:	
LT-10 CIRCUIT DIAGRAM	
H. H. SCOTT, INC. MAYNARD, MASS., U. S. A.	
DR: R. D., W. C., D. R.	ENG: <i>[Signature]</i>
CH: <i>[Signature]</i>	PROD:
DWG. NO. C-LT-10-C1 sub 1	

DWS. NO. C-LT-10-C1

