

# OPERATING MANUAL

**SCOTT 382-B SOLID STATE AM / FM STEREO TUNER/AMPLIFIER**  
**SCOTT 342-B SOLID STATE FM STEREO TUNER/AMPLIFIER**



H. H. SCOTT

# LOOK HOW EASY TO OPERATE YOUR 382-B SOLID STATE STEREO RECEIVER

## INPUT

Phono Low and Phono High — for phonograph records. (See page 12)

FM — For FM-Mono and Stereo. The tuner will automatically switch to stereo if you are tuned to a stereo broadcast (a light will indicate this). If the program is monophonic, the tuner will instantly switch to that mode of operation. The tuner does all the thinking for you.

AM — To receive AM stations. (Standard Broadcast) Extra — For any device connected to the extra inputs on back. (see page 10)

## MODE

For all stereophonic program material, set to Stereo position. Mono position for monophonic material. (see page 11)

## BALANCE

(see page 11)

## LOUDNESS/BALANCE

Makes system louder or softer to suit your taste. To make one speaker louder than the other. Permits you to adjust for unequal sounds caused by room acoustics or faulty program material. (see page 11)

## BASS

Modifies low frequency sounds. Set to suit your taste. (see page 12)

## TUNING METER

For best listening adjust the tuning dial so that you get the highest possible reading on the meter. (see page 13)

## NOISE FILTER

Out — For normal listening.  
In — To reduce high frequency noises such as record surface noise, or hiss on distant stations. (see page 12)

## TUNING KNOB

To select the desired FM or AM station.

## LOW LEVEL OUTPUT

To connect a set of low impedance stereo headphones. (see page 12)

## POWER

To turn the receiver on or off. (see page 12)

## SPEAKERS

1. MAIN switch on; REMOTE switch off: main speakers only
2. MAIN switch on; REMOTE switch on: both main and remote speakers
3. MAIN switch off; REMOTE switch on: remote speakers only
4. MAIN switch off; REMOTE switch off: earphones only

(NOTE: Earphones may be used whether MAIN and/or REMOTE switches are in on or off position)

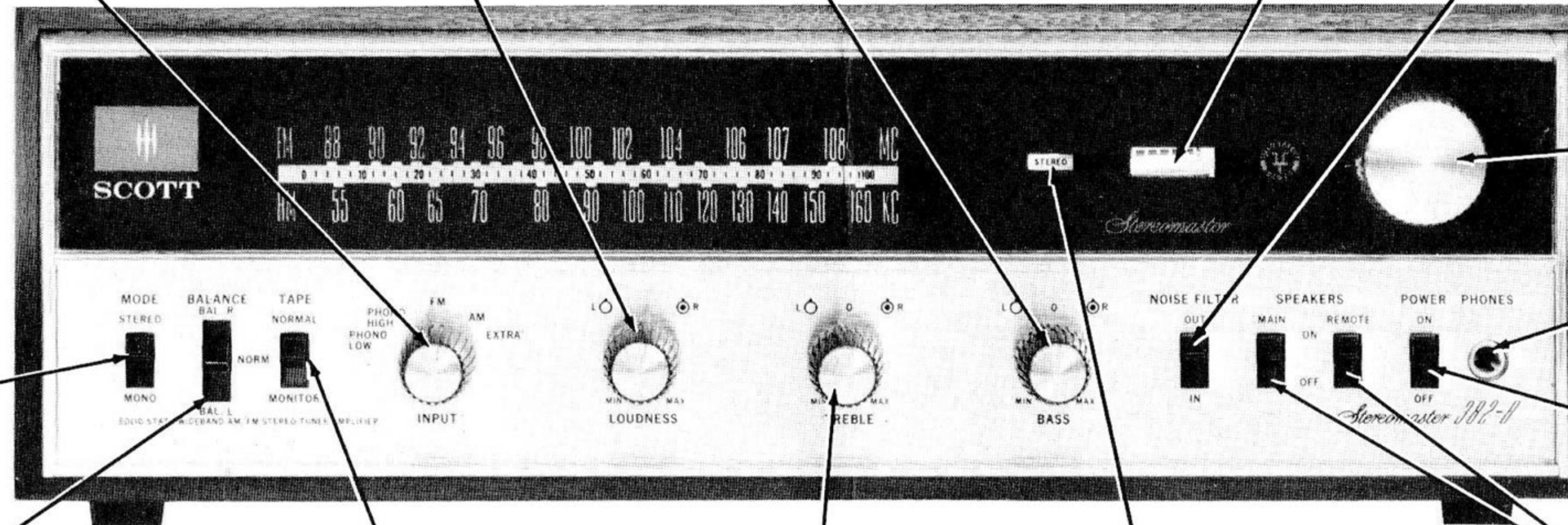

# SEE HOW EASY IT IS TO CONNECT YOUR SCOTT 382-B SOLID STATE STEREO RECEIVER

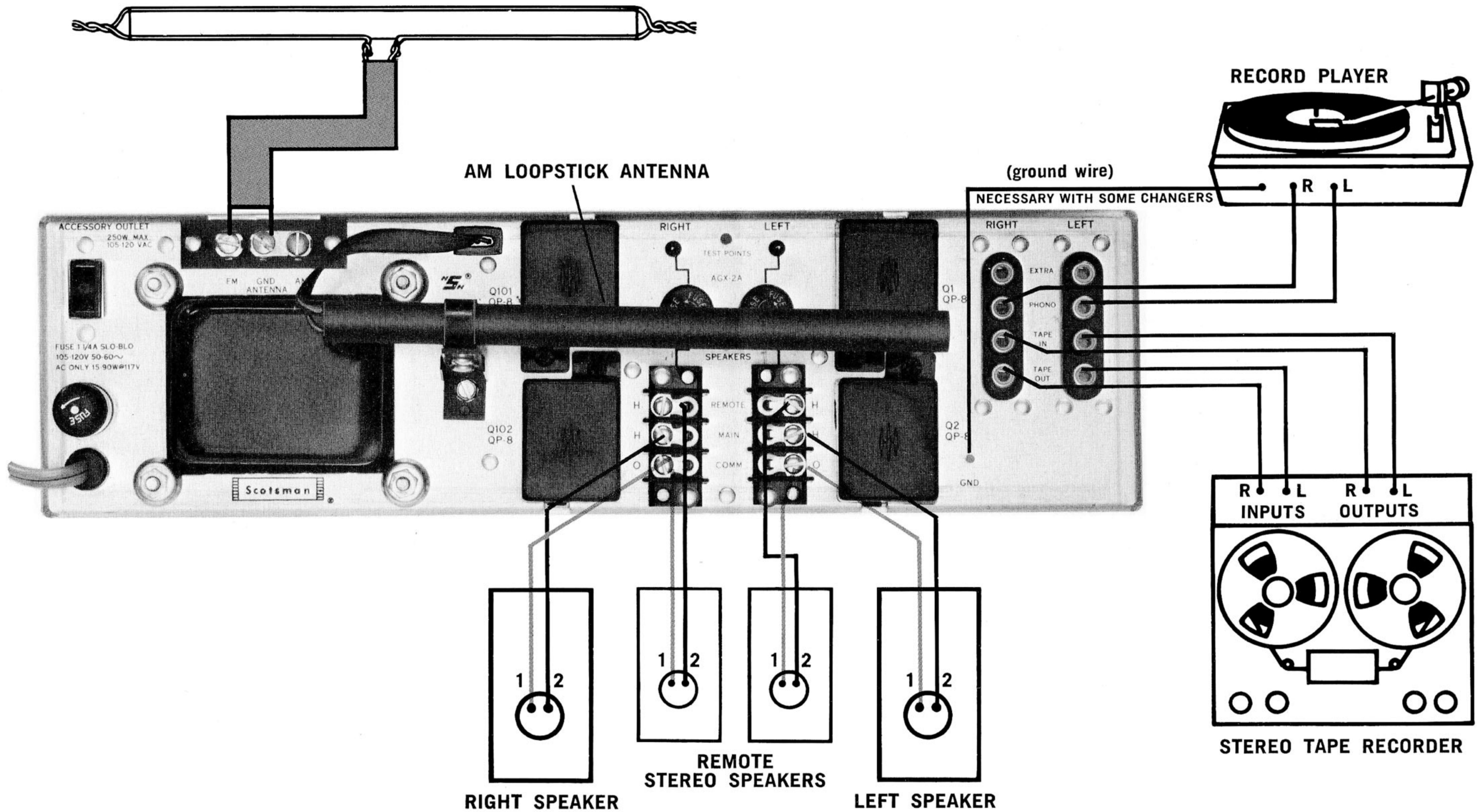

# LOOK HOW EASY TO OPERATE YOUR 342-B SOLID STATE STEREO RECEIVER

## INPUT

Phono Low and Phono High — for phonograph records. (See page 12)

FM — For FM-Mono and Stereo. The tuner will automatically switch to stereo if you are tuned to a stereo broadcast (a light will indicate this). If the program is monophonic, the tuner will instantly switch to that mode of operation. The tuner does all the thinking for you.

Sub. Ch. Filter — To receive FM stereo broadcasts when some background noise is present. (see page 12)

Extra — For any device connected to the extra inputs on back. (see page 10)

## MODE

For all stereophonic program material, set to Stereo position. Mono position for monophonic material. (see page 11)

## BALANCE

(see page 11)

## LOUDNESS/BALANCE

Makes system louder or softer to suit your taste. To make one speaker louder than the other. Permits you to adjust for unequal sounds caused by room acoustics or faulty program material. (see page 11)

## BASS

Modifies low frequency sounds. Set to suit your taste. (see page 12)

## TUNING METER

For best listening adjust the tuning dial so that you get the highest possible reading on the meter. (see page 13)

## NOISE FILTER

Out — For normal listening.  
In — To reduce high frequency noises such as record surface noise, or hiss on distant stations. (see page 12)

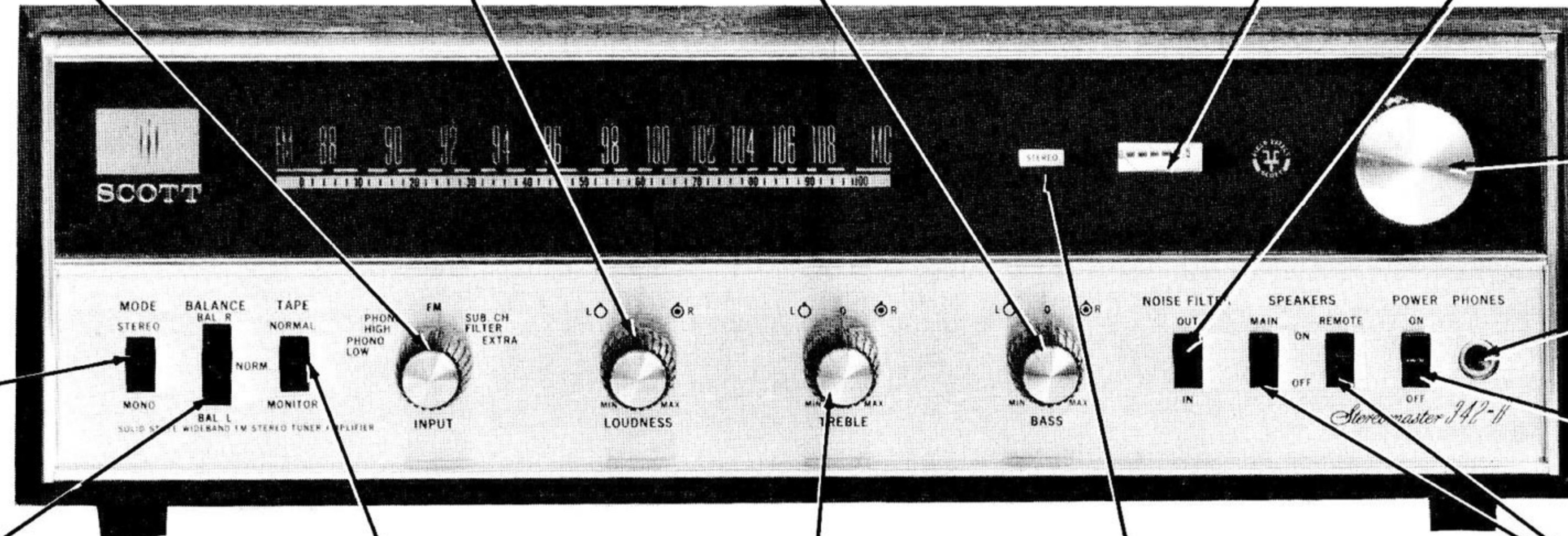

## TUNING KNOB

To select the desired FM or AM station.

## LOW LEVEL OUTPUT

To connect a set of low impedance stereo headphones. (see page 12)

## POWER

To turn the receiver on or off. (see page 12)

## SPEAKERS

1. MAIN switch on; REMOTE switch off: main speakers only
2. MAIN switch on; REMOTE switch on: both main and remote speakers
3. MAIN switch off; REMOTE switch on: remote speakers only
4. MAIN switch off; REMOTE switch off: earphones only

(NOTE: Earphones may be used whether MAIN and/or REMOTE switches are in on or off position)

## TAPE

To listen to tape played on a regular Tape Recorder. This switch can also be used to monitor a recording when used with a tape recorder with separate playback and record heads. (see page 11)

## TREBLE

Modifies high frequency sounds. Set to suit your taste. (see page 12)

## STEREO INDICATOR

Lights up when tuned to an FM stereo broadcast.

# SEE HOW EASY IT IS TO CONNECT YOUR SCOTT 342-B SOLID STATE STEREO RECEIVER

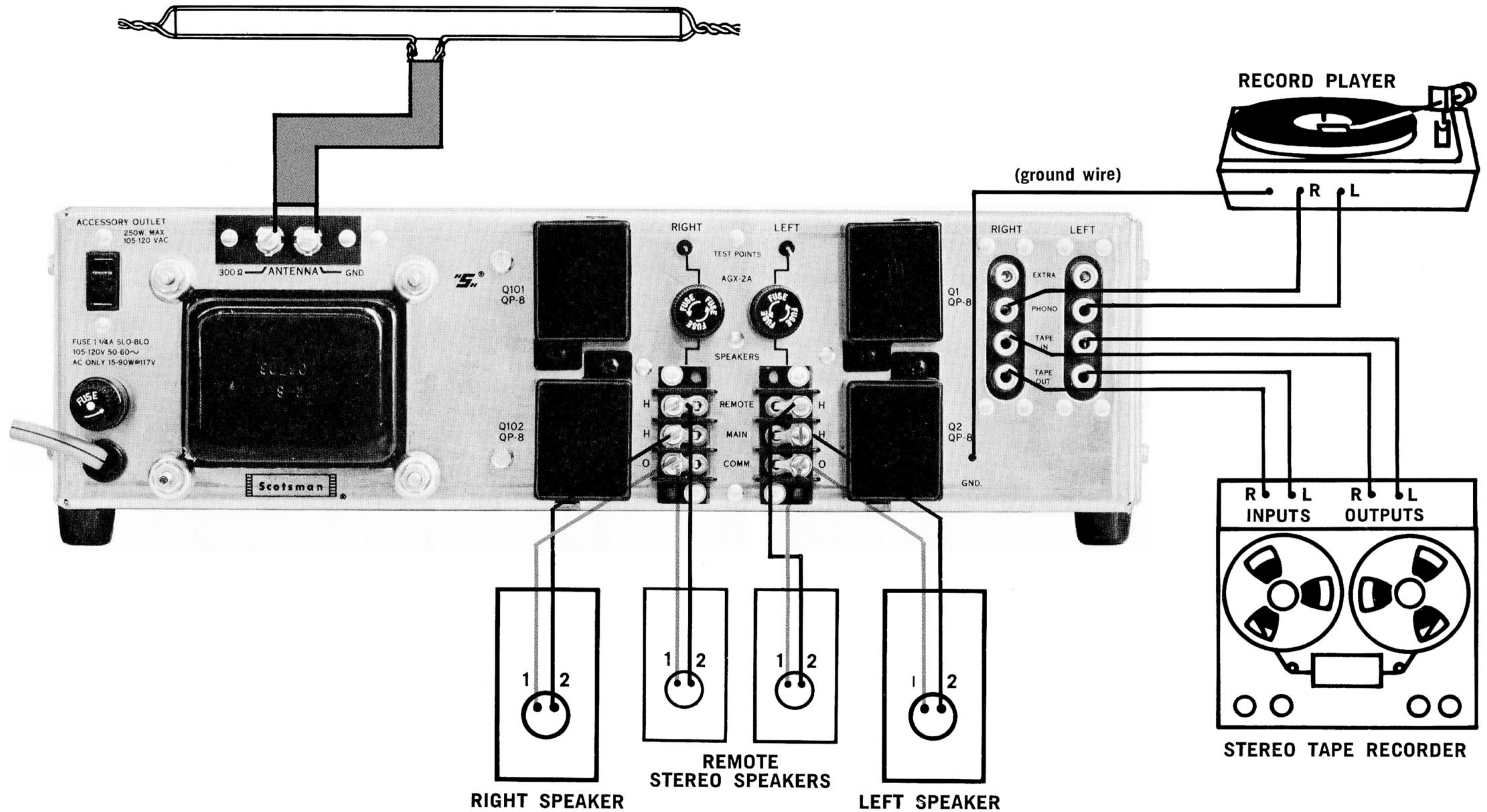

## INTRODUCTION

Your new tuner-amplifier represents a significant breakthrough in the design of quality music reproducing equipment for the home. Frequently, manufacturers have been forced to sacrifice some part of the best possible performance in order to combine a stereo tuner and stereo amplifier on one chassis. There is no compromise in your new Scott tuner-amplifier. The remarkable design and unique features that make separate Scott tuners and amplifiers outstanding are fully represented in this combination unit.

In the next few sections you will read about Scott leadership in both amplifiers and tuners. The sum of this leadership is the Scott tuner-amplifier; representing the ultimate in performance, appearance, and operating convenience. We are sure you will find this background material of interest.

Although your tuner-amplifier is a simple instrument for any member of the family to operate, to obtain the maximum enjoyment, read this entire instruction booklet carefully and thoroughly. You will find it well worth the time.

## HOW FM STEREO (MULTIPLEX) WORKS

Multiplexing is a method of broadcasting two or more signals from one FM transmitter. This means that a single FM station can broadcast both the left and right channels of a stereophonic program from records, tapes, or live performances.

Humans are capable of hearing sounds between about 20 and 20,000 cycles per second. Any sound above 20,000 cycles per second is referred to as "supersonic" because it is above the range of human hearing.

Most good FM tuners are capable of reproducing these supersonic frequencies above 20,000 cycles per second ("cps" for short). Though you cannot hear them, these supersonic frequencies are used very effectively for multiplex. At a frequency of 38,000 cycles per second (cps), high above the sounds you can hear, the second (stereo information) signal is added on. While you can't hear this second signal, your FM tuner can, and, if equipped for multiplex, will convert this into sound you can hear—stereo sound.

This second signal is not either the left or right channel. If it were, a listener with a monophonic tuner would hear only half of the program. Instead (see diagram pg. 1), a method is used that provides the full monophonic signal (left plus right) for the listener with a regular FM tuner, and stereo for the listener with multiplex equipment. The stereo quality depends on how well the multiplex tuner handles the second signal (stereo information). If very little of the second signal is being properly processed, there will be poor stereo quality (poor separation between the left and right channels). Simply having sound from both speakers does not necessarily mean you have stereo.

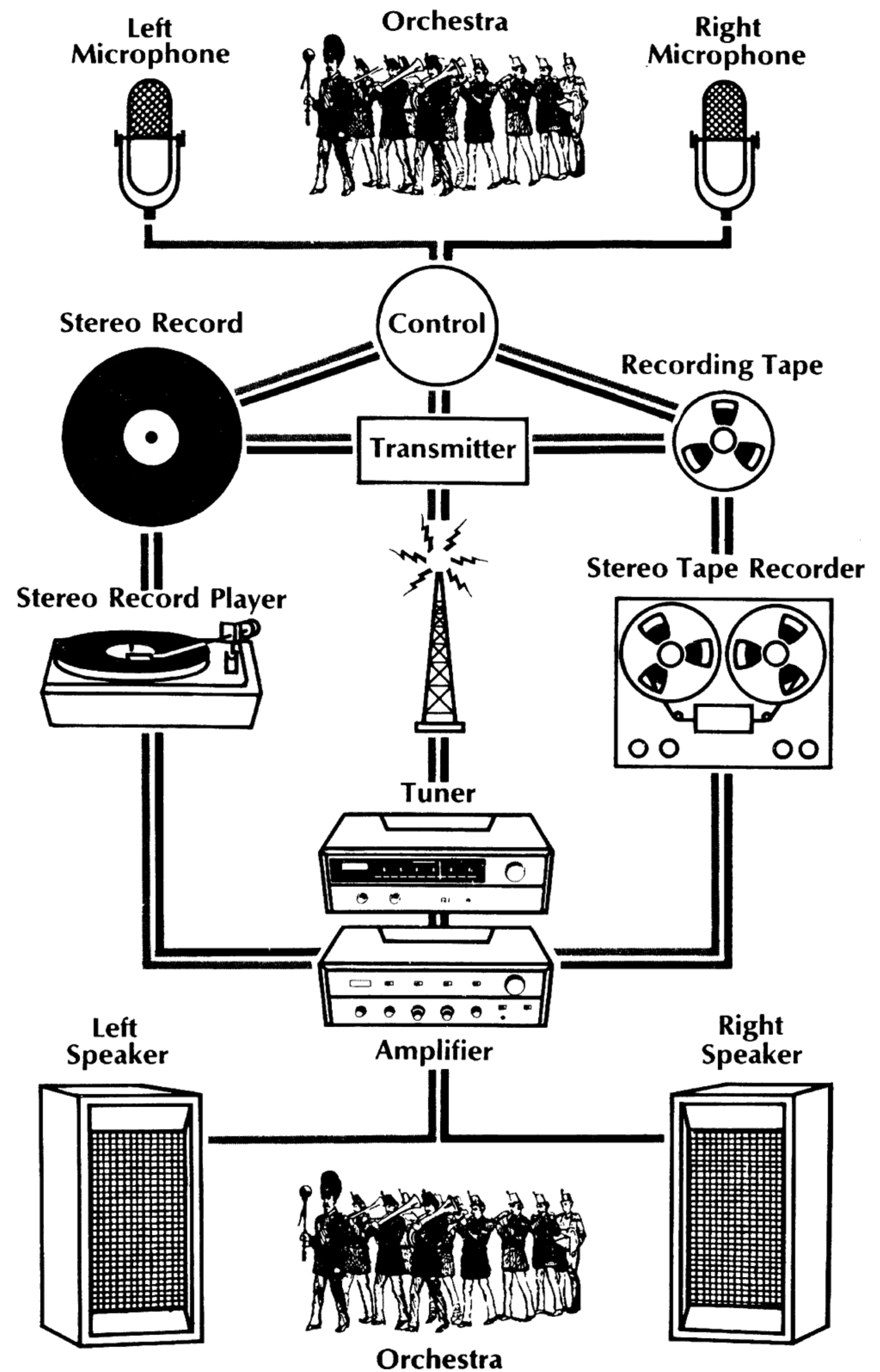

Conventional narrow-band tuners cannot give the fine stereo quality obtained with Scott Wide-Band tuners. As the FCC pointed out, the approved multiplex stereo system "... like any multiplex transmission system, will increase energy transmission at the edges of the channel involved. Accordingly for optimum stereophonic reception, the (tuner's) bandwidth ... must be considerably greater than that of monophonic (tuners)..." Scott tuners have always had the wider IF bandwidth needed.

Since stereo FM broadcasts are such an abundant source of high quality program material, many listeners will want to make off-the-air stereo tape recordings. In many instances, however, conventional multiplex circuitry causes interference with a tape recorder, resulting in whistles and beeps being recorded on the tape. Scott multiplex units incorporate the extensive filters needed to prevent this interference. Scott equipment can be used with any tape recorder.

New FM Stereo will bring you thrilling broadcasts of world famous symphony orchestras and opera companies ... intimate close-ups of jazz in stereo ... dramatic presentations with life-like movement. You will hear the wonderful new sound of FM multiplex stereo in your home ... and using Scott equipment, you will be able to make flawless off-the-air stereo tape recordings.

## HERE'S WHAT MAKES SCOTT TUNERS SO OUTSTANDING

FM stereo multiplex reception makes more severe demands on a tuner than regular monophonic reception. You will undoubtedly enjoy your new Scott tuner-amplifier much more if you have some understanding of the unique engineering that makes it so outstanding. Below are some various factors that go into the design of a Scott tuner.

### COMPARATRON CIRCUIT

This is a computer-like device that compares the incoming signal with a fixed noise signal. If the incoming signal includes only noise, Comparatron stays in the monophonic mode. If a 19 kc multiplex pilot is present, Comparatron instantly switches to stereo. This gives you quick, foolproof, and quiet stereophonic switching. Changes in signal strength will not cause stereo to switch in and out as is the case with many automatic devices.

### FLAT-LINE LIMITING

New circuits make the tuner impervious to pulse noises. Output of the tuner will vary less than 1 db between weak distant stations and strong local stations. This means that it will provide quiet, noise-free reception regardless of automobile ignition, apartment house elevators, and other electrical noises. You can tune across the dial and do not have to readjust the volume control as you pass from one station to another.

## NEW SCOTT FIELD-EFFECT TRANSISTOR FRONT END

This special Scott design employs the latest development in solid state technology. The use of field-effect Transistors (FET's) assures you of superior signal-to-noise ratio, cross modulation rejection, and sensitivity. The use of solid state devices assures you of years of trouble-free performance without the need for frequent realignment.

### INTEGRATED CIRCUIT IF STAGE

Used in the vital FM tuner IF (for Immediate Frequency) strip, Scott Integrated Circuits actually allow the use of more circuitry in less space. Each Scott IC contains five transistors and two resistors. There are four Scott IC's used in each IF strip ... making a total of twenty transistors. This is in marked contrast to the IF strip the new unit replaces, which contains five transistors.

### SERIES GATE, TIME-SWITCHING MULTIPLEX CIRCUIT

Scott's advanced solid state circuit takes advantage of the amazing switching capabilities of transistors to provide separation in excess of 35 db. This sets new standards of stereo realism. The tuner has far greater separation than most stereo records and broadcasts.

### BI-SYMMETRIC AUDIO OUTPUT STAGE

Scott's unique high feedback network around the final audio output stages assures perfectly matched output signals on each channel. You can make off-the-air tape recordings of truly professional quality.

## HERE'S WHAT MAKES SCOTT AMPLIFIERS SO OUTSTANDING

The first true high fidelity amplifier was Scott's world famous 210-A which appeared in 1947. This remarkable instrument introduced a score of unusual design features which today are accepted and used by all manufacturers. The engineering innovations in the 210-A are typical of H. H. Scott, a company which has continued to pioneer in the audio field. The exceptional design and careful manufacture that went into the 210-A have been proven over the years ... most are still in service—working perfectly.

Scott's philosophy is not only to develop new and better instruments, but also to produce equipment that will last. There is no built-in obsolescence in Scott's products. Here are a few of the "extras" Scott has included in your new tuner-amplifier:

- Non-magnetic aluminum is used as chassis material on all Scott components rather than low cost steel. Aluminum acts as a shield against induced hum, and is an ideal heat dissipator guaranteeing long life and cool operation of the entire unit.
- To avoid unpleasant hum and noise, Scott uses specially selected pre-amplifier transistors.

- All Scott amplifier sections are 100% stable with any type of load or with no load. You never have to worry about harming your tuner-amplifier transistors.
- The aluminum chassis used as the output heat-sinks in the amplifier section means that you will get plenty of continuous output power at the low frequencies where power is really needed. Any amplifier can meet its rated specifications in the mid-range. It is in the vital low frequency region that Scott transistor amplifiers prove so far superior.
- All Scott amplifier sections incorporate a subsonic sharp cutoff filter. This prevents all noise and rumble below 20 cps from entering the amplifier stage and causing the amplifier to waste its power on undesirable noises. By concentrating on the audible range, a Scott amplifier gives usable power far in excess of its conservative rating.
- All components and parts are carefully checked. They are used far below their rated values. You can be sure that your new Scott tuner-amplifier will meet its specifications, both now and for years to come.

## INSTALLATION

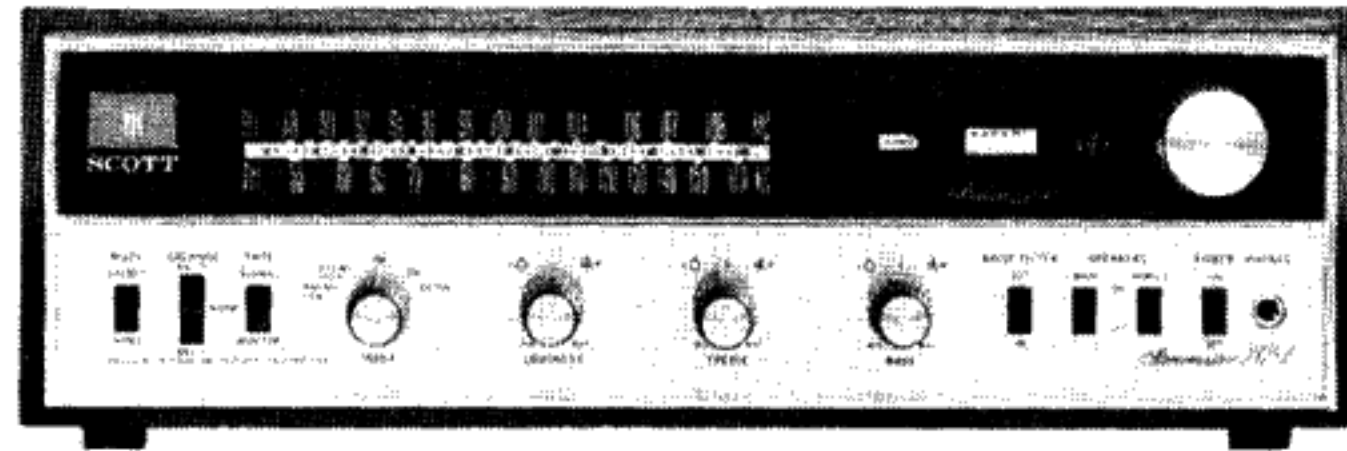

Your Scott tuner-amplifier can be placed on a table or bookshelf, in existing furniture like an end table, buffet, or room divider, or in a specially designed equipment cabinet. A handsome hand rubbed wood accessory case is available from your dealer in finishes to blend with your decor.

Wherever it is placed, adequate provision should be made for ventilation. If this is not done, the life of the internal components will be appreciably shortened. By adequate ventilation we mean about 4" of space above the unit where air may circulate freely, or, if it is installed in a cabinet, the cabinet should have an open back. Airspace of 1/4" or open shelving should exist underneath.

To help disperse heat rapidly, Scott employs aluminum in the construction of the chassis, panel, and heat sinks. Aluminum is an excellent conductor of heat.

The tuner-amplifier should generally be mounted horizontally because of the necessity for proper heat dissipation. If vertical mounting is desired, forced air ventilation with a fan is a must. Fans specially designed for this purpose can be obtained from your dealer.

## CONNECTIONS TO A STEREO SPEAKER SYSTEM

The unique flexibility of your tuner-amplifier permits you to use two pair of stereo speakers—one set for your main listening room and another set in any other room you choose.

You can select either set of speakers on both sets, by the **SPEAKERS** switches located on the front panel.

The instructions that follow are for connecting both the **MAIN** and **REMOTE** speakers. Make sure that the main speakers are connected to the **MAIN** "O" and "H" terminals on both terminal boards, and the remote speakers are connected to the **REMOTE** terminals on both channels.

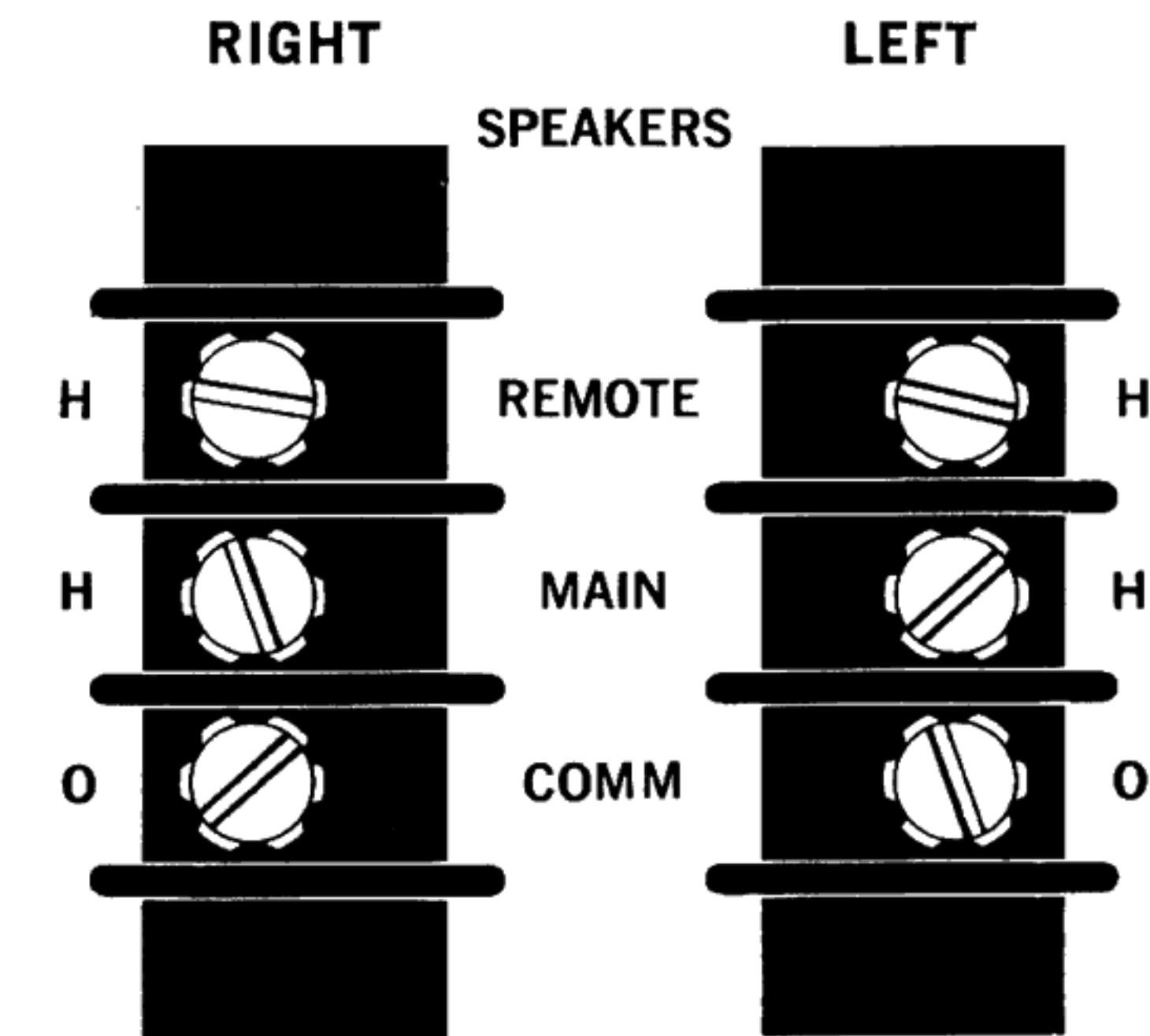

Terminal strips for speaker connections are located on the rear of your tuner-amplifier. The screw terminal marked Right is for connecting the right-hand speaker (as you face them from your listening area); the terminal marked Left is for the left-hand speaker.

When making connections, you can use almost any type of wire if the lengths are under 50 feet. We highly recommend ordinary lamp wire (#18 wire according to the electrical code). If you want to run the wire under a rug, you can also use flat TV antenna wire. If you plan to use wire lengths considerably in excess of 50 feet, it is advisable to use #16 wire to prevent excessive losses of power.

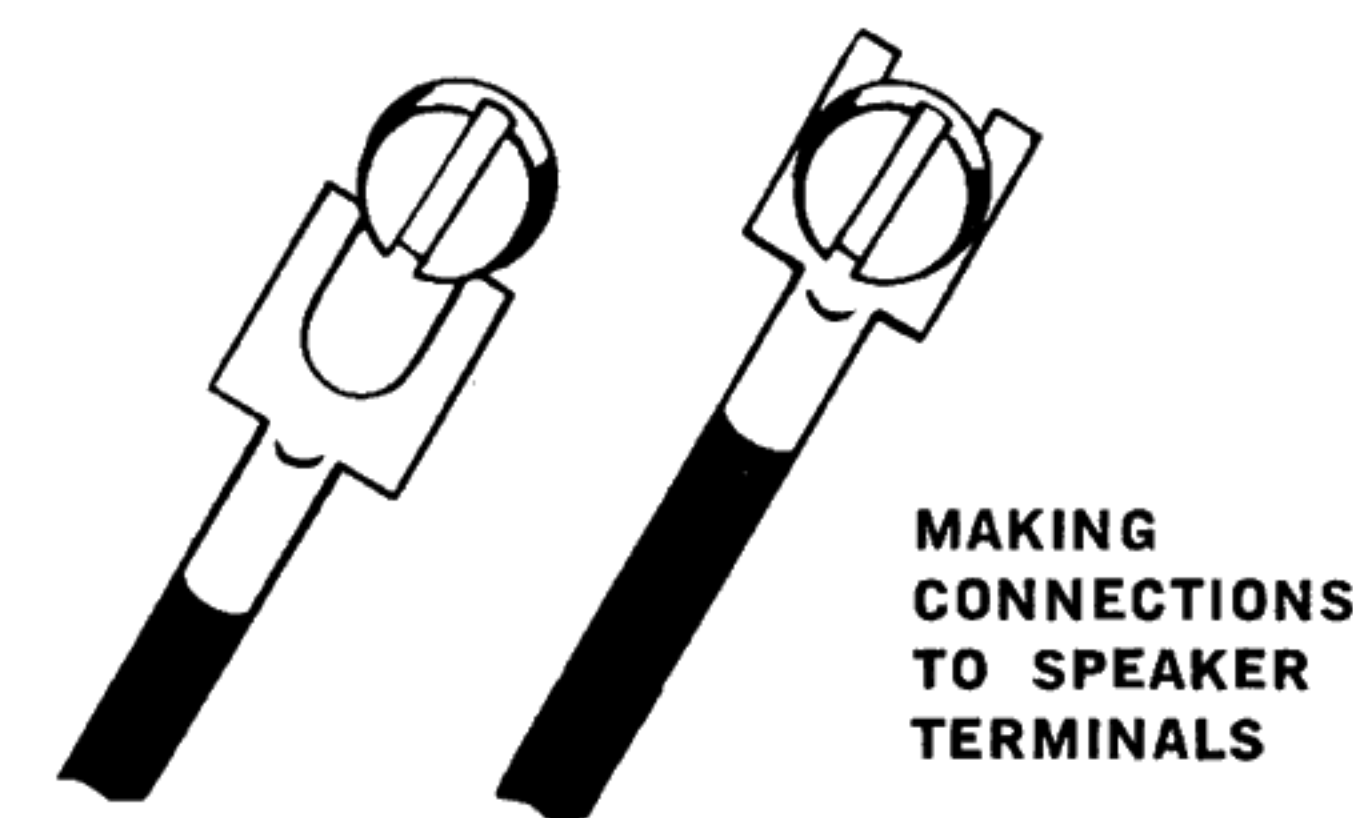

When attaching the wire to the tuner-amplifier or the speaker, be certain that strands of wire from one screw do not accidentally touch strands on any other screw or you will cause a speaker fuse to fail. It is strongly recommended that spade lugs (see illustration) be used. Since phasing is important in Stereo speaker systems, use a color coded wire, one with a marker yarn, raised bead or

some other means of distinguishing one wire of the pair from the other. SPT "ZIP cord" usually has one wire of the pair identified by a thin outside rib on the insulation.



**NOTE:** When connecting your speakers, be sure not to touch the ends of the speaker lead together. This results in a short circuit which can cause the speaker fuse to fail. While this will cause no permanent damage, it will necessitate fuse replacement.

In order to minimize the chances of speaker fuse replacement in the event of an accidental speaker lead short circuit, the following precautionary steps are suggested:

1) Use spade lugs (as mentioned above) for all speaker lead connections.

2) Turn the LOUDNESS Control all the way down to "0" or turn the 342 off when making the speaker connections.

3) Connect the wire to the speakers *first*; then to the speaker output terminals on the receiver.

**To Stereo Speaker Systems**—Most speakers have one or all of the terminals coded or numbered. Make sure that the speakers are properly phased when connecting them by attaching corresponding terminals on the speakers to corresponding terminals on the amplifier. Example: "O" on the amplifier to "O" on the speaker and "H" on the amplifier to "H" on the speaker. The other speaker is hooked up in the identical manner with a second pair of coded wires.

**To A Single Speaker System**—If you only own one speaker system and plan to add a second speaker for stereo at a later date, treat the single speaker as a left channel speaker and operate the amplifier with the MODE switch in the **Mono** position at all times. Though it is not safe to operate conventional amplifiers without a speaker load; all Scott amplifiers are completely stable with resistive, capacitive, inductive, or no load. You need never fear injury to your amplifier by using it with no load.

### PHASING THE LOUDSPEAKERS

The two loudspeakers of a stereo system must be properly "phased" or in step. The cones must move back and forth at the same time. If the right cone is moving forward when the left cone is moving backward, there will be a noticeable reduction in the bass response as well as poor stereophonic effect. These speakers are "out of phase."

If you are unable to purchase coded wire (as previously described), you will have to phase the speakers. When phasing the loudspeakers, be careful not to touch the speaker wires together which would cause a speaker fuse to fail. In order to minimize the chances of a blown fuse reverse the speaker wires at the amplifier rather than at the speaker. If you have someone to help, have them turn down the LOUDNESS control momentarily while you are reversing the wires.

Tune to a monophonic broadcast with a male voice speaking or play a monophonic record with a male singing voice. Turn the LOUDNESS control to full room level. Stand in front of the two stereo speakers and midway between them. Quickly reverse the wires to one speaker. With the correct connection, the voice will sound full and appear to be coming

from a source directly between the two speakers. In the wrong position, the voice will lose some bass response and will appear to be coming from both speakers.

**DO NOT ATTEMPT TO HOOK UP BOTH CHANNELS OF THE RECEIVER SPEAKER OUTPUTS TO A SINGLE SPEAKER SYSTEM.**

You won't get "twice the power" and may seriously damage the output stages of the receiver.

### ADDING MORE THAN ONE SPEAKER TO ONE OUTPUT TERMINAL

Under no circumstances should an impedance of less than 4 ohms be connected to the speaker terminals of the receiver. If less than 4 ohms is connected, damage to output stages can occur.

Should you wish to connect other stereo speakers *in addition* to the MAIN and REMOTE sets, this will mean that there will be two speaker systems connected to the MAIN or REMOTE terminals. If this is the case, great care should be taken to make sure that the *combination* of speaker systems connected to the one speaker terminal does not result in an impedance of less than 4 ohms. For instance, while you can connect one 4 ohm speaker to the MAIN speaker output terminal, you cannot add another 4 ohm speaker *in parallel* to this same terminal as the resultant impedance would be 2 ohms—an impedance that might cause considerable damage to the output stage of the receiver.

It would be possible to connect two 4 ohm speakers *in series*, but this method is never recommended for any high fidelity installations, as series-connected speakers can interact with one another causing lower quality performance.

When selecting additional speakers for this purpose, use the following formula for determining overall impedance in parallel speaker connections:

Multiply the impedance of speaker #1 by the impedance of speaker #2.

Divide the result by the sum of the impedances of the two speakers.

Example: Speakers #1 and #2 are both 8 ohms; following the formula:

$$8 \times 8 = 64$$

$$8 + 8 = 16$$

$$64 \div 16 = 4 \text{ ohms}$$

This would be an acceptable impedance.

### FOR MULTIPLE SPEAKER HOOKUP INFORMATION SEE APPENDIX ON PAGE 14 POWER

The power cord should be plugged into any 105 to 120 volt, 50 or 60 cycle AC source (wall outlet). Do not attempt to use with a DC outlet.

## CONNECTING FM ANTENNA

An FM dipole antenna is supplied with the unit. In strong signal areas this should be more than adequate to pull in most of the FM stations available. Antenna connections are made to the terminal strip marked "Antenna" located on the back panel. The dipole leads are connected to the screws marked "G" and "300 Ω" respectively as shown. The dipole should then be opened to full "T" and positioned to give the strongest signal possible on the tuning indicator on the front.

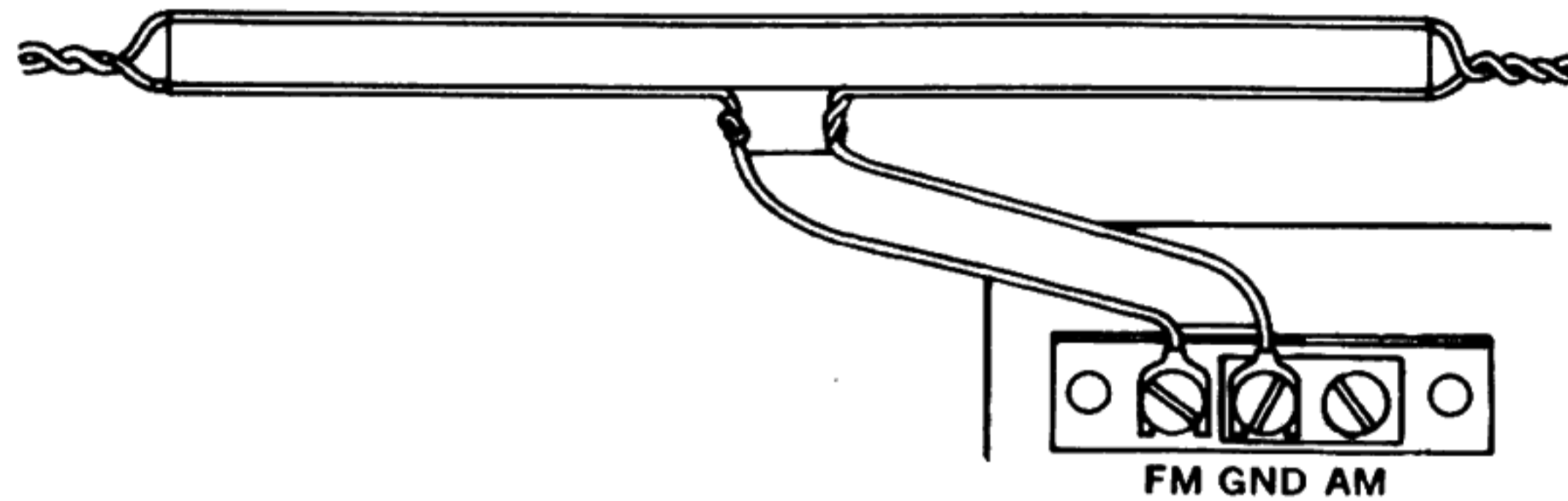

*(382-B FM antenna connection)*

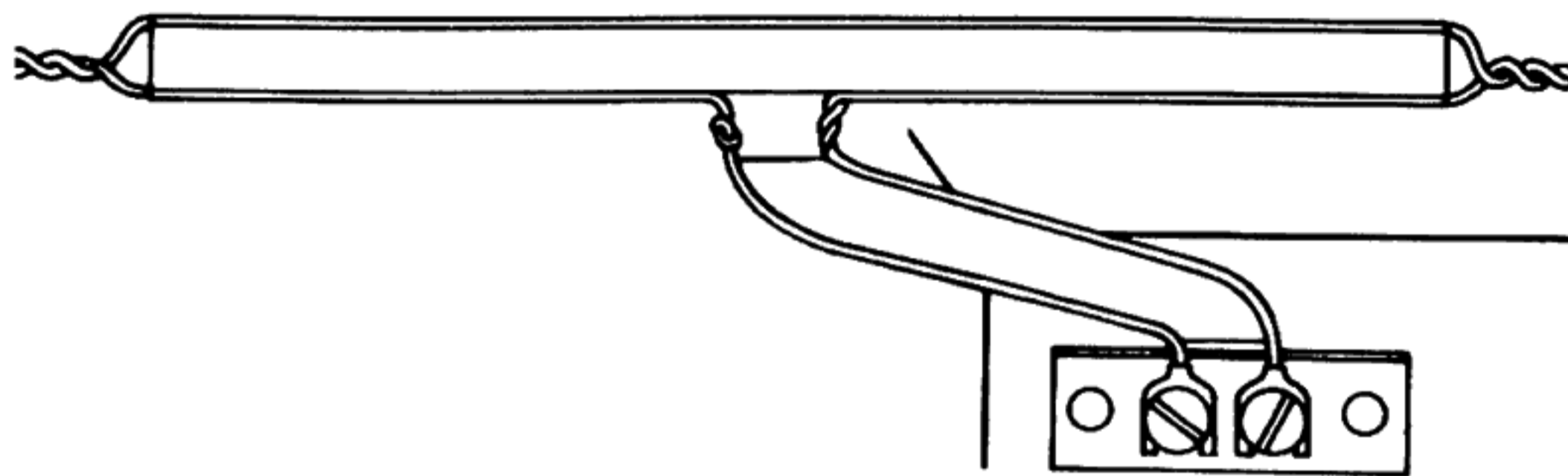

*(342-B FM antenna connection)*

The dipole may have to be shifted slightly when trying to receive stations at different directions from the listener. A compromise position can usually be found that will work best for most of the stations desired. Generally, the higher the dipole can be placed, the stronger the signal. If you wish to place the dipole further away than its present lead length permits, you can purchase from your dealer additional lengths of 300 ohm antenna wire to connect between the dipole and the antenna terminals.

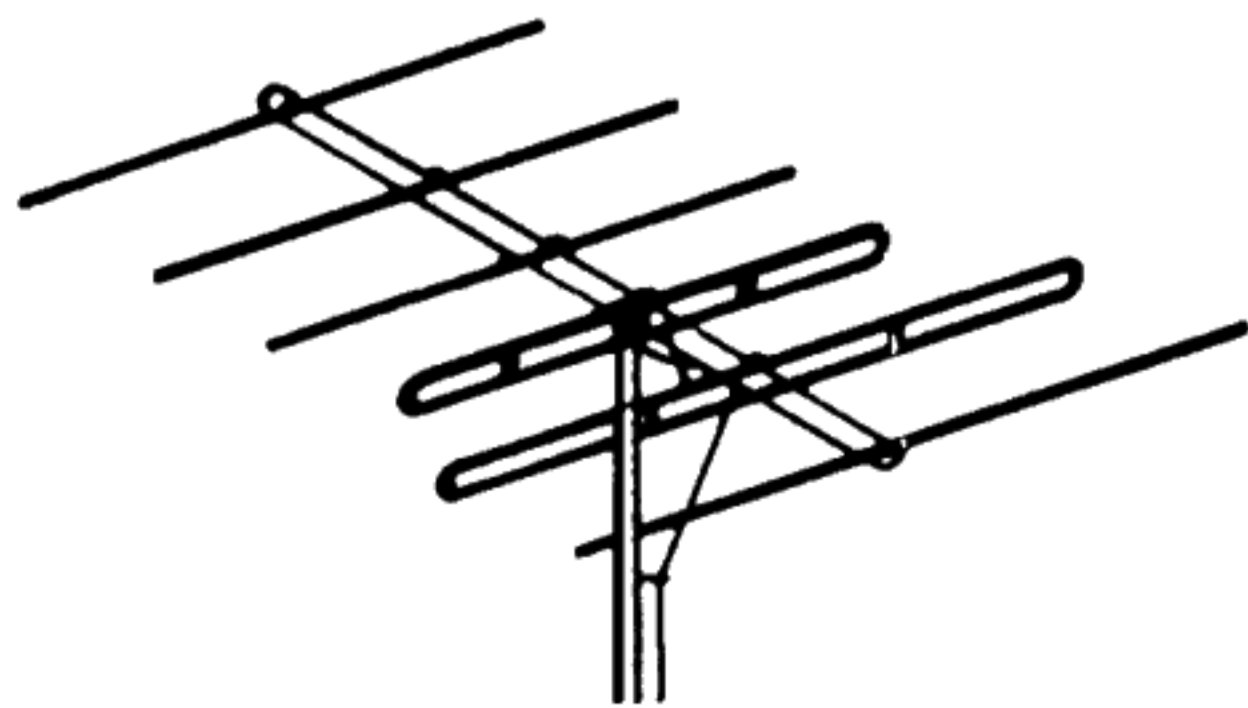

In fringe areas, or areas of high interference, an external directional antenna may be necessary. This is particularly true with multiplex stereo reception. Reflections from hills or nearby tall buildings can cause annoying distortion. There are many fine yagi FM antennas available which will provide strong signal and reduce interference thus enhancing the range

of the tuner. The remarkable sensitivity of your Scott tuner-amplifier, when combined with a good antenna, will permit you to receive an astonishing number of distant FM stations, either monophonically or in stereo.

In areas of extremely high noise, such as a busy highway, the following system is suggested.

Mount a yagi antenna at some point as far removed from the source of the disturbance as possible. Use an impedance matching balun mounted on the antenna and run 72 ohm shielded antenna lead-in wire to the unit. Use another impedance matching balun at the antenna terminals of the unit. Since the yagi antenna is extremely directional, it is important that it be positioned for the best reception of desired stations. In areas where stations are available in diverse directions, an antenna rotator is suggested.

## CONNECTING THE AM ANTENNA (382-B ONLY)

This AM LOOP STICK antenna will provide a fair amount of signal and will permit you to listen to most local AM stations clearly. However, your AM reception may be tremendously improved by unscrewing the loop antenna from the chassis and moving it away from the tuner. Try setting it in different positions and by looking at the meter find one that gives a stronger signal.

To connect an external AM antenna, remove the link connecting the AM and GND screws on the ANTENNA terminal. Connect the external AM antenna to the AM terminal. In some instances a wire connected to the GND screw and a cold water pipe will reduce the noise level. Some experimentation may be necessary to achieve optimum results. It is suggested that you refer to the ARRL antenna book published by the American Radio Relay League for a full discussion on AM antenna systems.

## LOOPSTICK ANTENNA

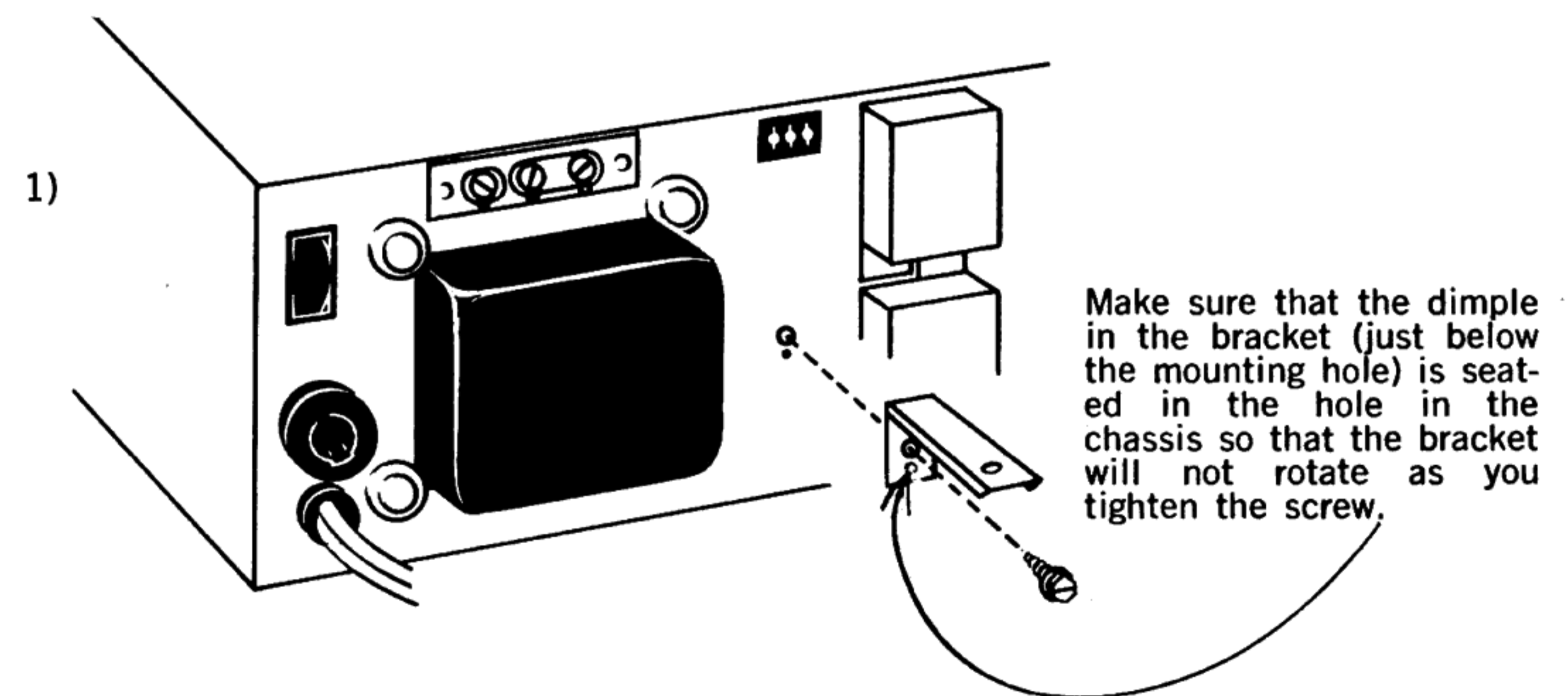

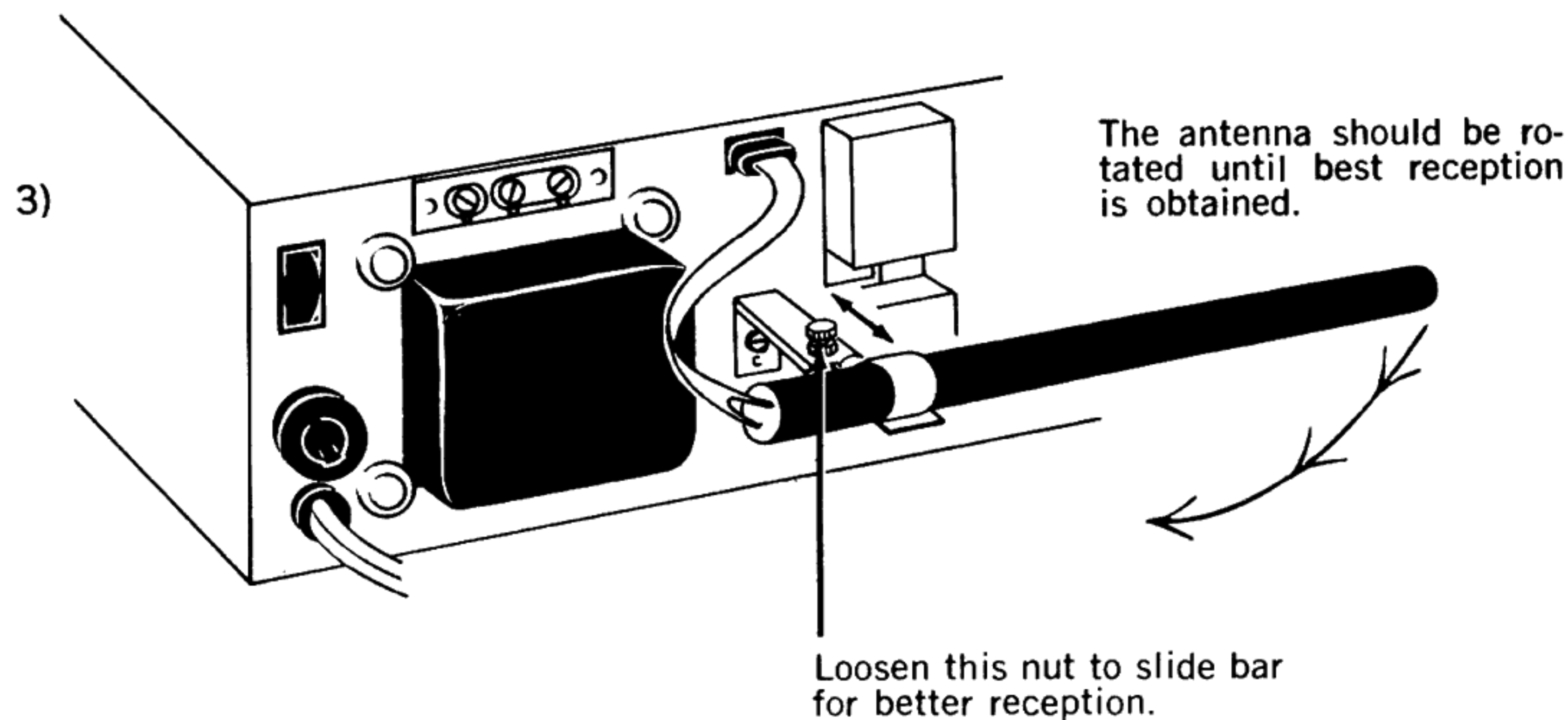
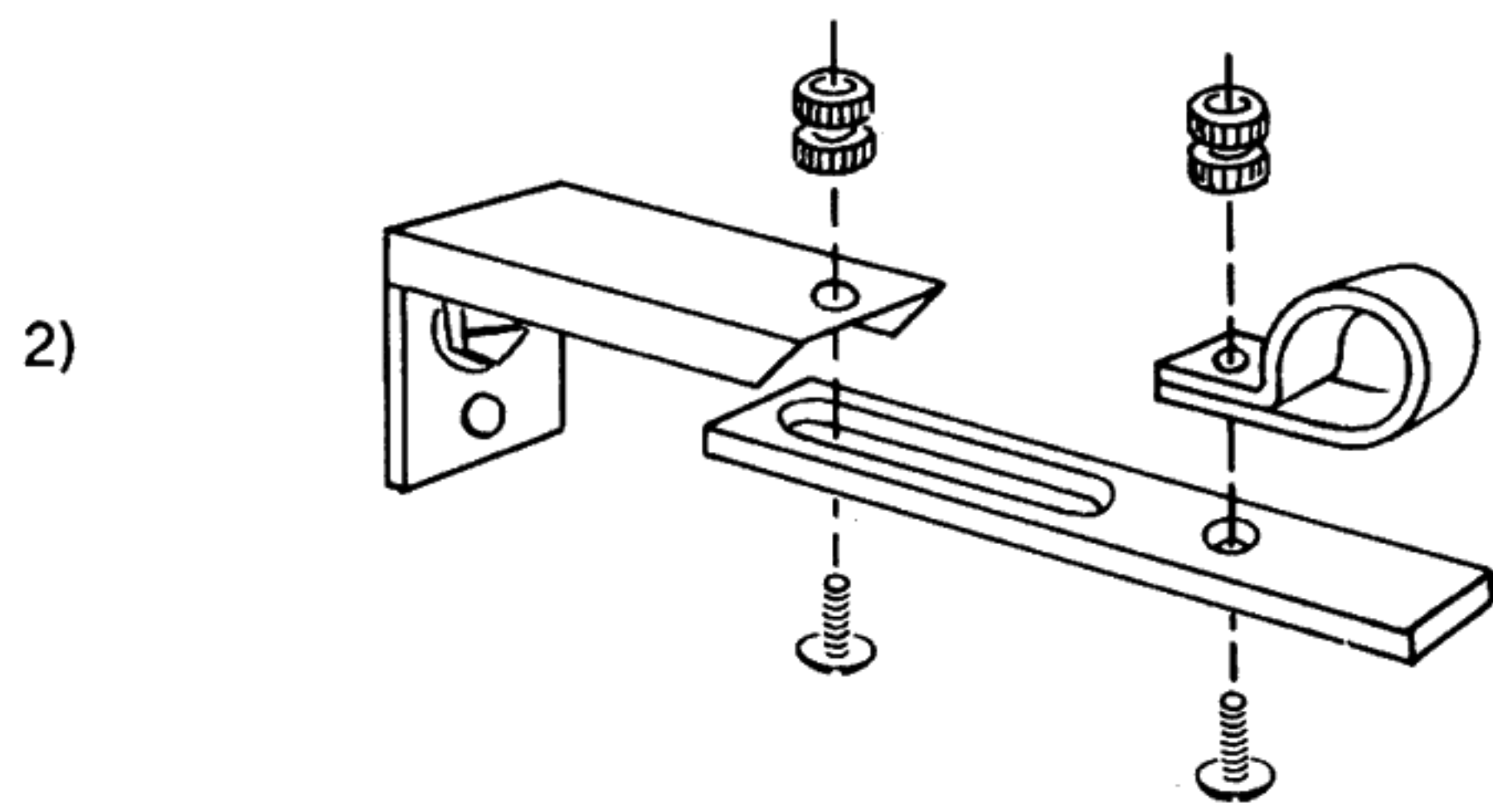

If only a single AM antenna wire is used, it should be at least fifteen feet of lamp or bell wire. Connect one end to the AM screw on the AM ANTENNA terminal strip and run the other end of the wire to some point outside the house, preferably on or near the roof.

When trying any of these suggestions, use the tuning meter on the front panel to judge whatever improvement has been made in signal strength.

### CONNECTING TO PHONO INPUTS

**IMPORTANT:** Always turn the **LOUDNESS** control all the way down to "0," or turn the power off whenever connecting or disconnecting any cables to the receiver. Failure to do this may result in extensive replacement of transistors.

### STEREO RECORD PLAYER WITH MAGNETIC CARTRIDGE

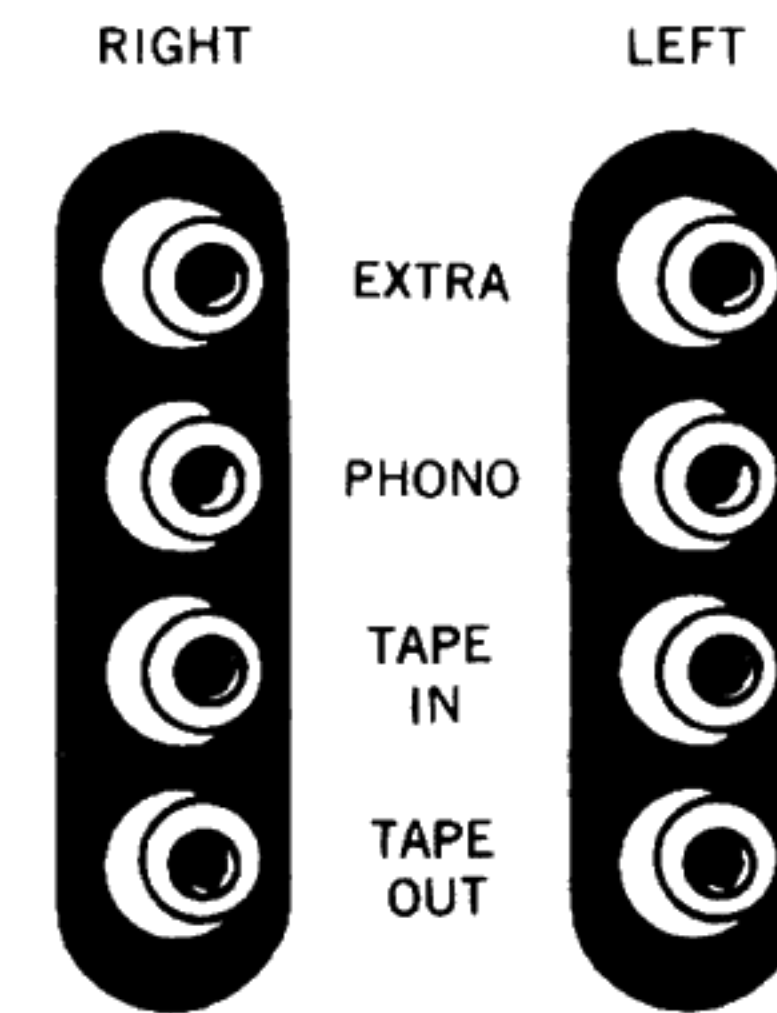

Magnetic cartridges are generally considered the best for faithful reproduction of the sound in the record groove. However, their electrical output is very small, on the order of a few millivolts (thousands of a volt). The output is so small that your amplifier incorporates a special circuit known as a pre-amplifier section, specially designed to give this tiny signal a large boost before it goes into the regular power amplifier section.

There is a wide variation in output from one make and model of magnetic cartridge to another. Some cartridges produce outputs as low as 3 millivolts while others are over 12 millivolts. If the pre-amplifier is designed to amplify only a 3 millivolt signal, a 12 millivolt cartridge will overload the amplifier and create too much volume (and higher distortion). On the other hand, using a 3 millivolt cartridge with an input designed for 12, will not provide adequate listening volume:

Scott engineers have solved this problem by incorporating a two position phono sensitivity switch in the Input selector. For all cartridges below 5 millivolts output, use the PHONO LOW position. For all cartridges above 5 millivolts, use the PHONO HIGH position.

To connect a turntable or changer utilizing a magnetic stereo cartridge, connect the shielded leads from the player to the PHONO inputs on the back of the amplifier. Check the instructions provided by the record player manufacturer to be certain that you are inserting the left channel lead into the left input of the amplifier and the right input into the right channel.

### STEREO RECORD PLAYER WITH CERAMIC OR CRYSTAL CARTRIDGE

**IMPORTANT:** Always turn the **LOUDNESS** control all the way down to "0," or turn the power off whenever connecting or disconnecting any cables to the receiver. Failure to do this may result in extensive replacement of transistors.

Connect a crystal or ceramic cartridge to the Phono input. Use the special adaptors which are normally supplied with crystals or ceramic cartridges for this purpose. This type of cartridge can be plugged directly into the Extra inputs, however, some of the bass frequencies will be lost and the signal may sound "weak."

## MONOPHONIC RECORD PLAYER

The instructions outlined above are equally valid here. The only difference is that there will be only one lead to connect and this should be inserted in the Left input. To play a monophonic record so it is heard over both loudspeakers, turn the **MODE** switch to **MONO**.

## GROUNDING YOUR RECORD PLAYER OR TAPE DECK

Many turntables, changers, and tape decks must be grounded to reduce hum to unobjectionable levels. A copper colored screw will be found on the rear of your tuner-amplifier. A few turns with a screwdriver will loosen it. Connect any grounding wires to this screw, and then tighten. Carefully read all the instructions provided with your cartridge, record player, or tape deck relating to hum reduction. If unusual problems present themselves, write to the address given at the back of this manual.

## EXTRA INPUT

**IMPORTANT:** Always turn the **LOUDNESS** control all the way down to "0," or turn the power off whenever connecting or disconnecting any cables to the receiver. Failure to do this may result in extensive replacement of transistors.

An extra stereo input is provided for any other high level source you may wish to connect. You can connect a tape recorder, ceramic microphone, or sound from your TV set. If this extra source is a stereophonic device with two leads, connect the left channel lead to the left channel **EXTRA** input and the other to the right channel **EXTRA** input. Set the **INPUT** switch to **Extra**. If it is a monophonic device with only one lead, connect it to the left channel **EXTRA** input. To listen to this latter signal over both speakers, you should turn the **MODE** switch to **MONO** position and the **INPUT** to the **Extra** position.

## CONNECTING YOUR TAPE RECORDER TO MAKE TAPE RECORDINGS

Your Scott tuner-amplifier has a special set of outputs which permit you to record any signal passing through the unit. You can make tapes from your records or off-the-air from FM. The tape recorder is completely unaffected by the volume and the tone controls of the tuner-amplifier. If you want to turn the **LOUDNESS** down to "0", you can, and it will not affect the output to the tape recorder.

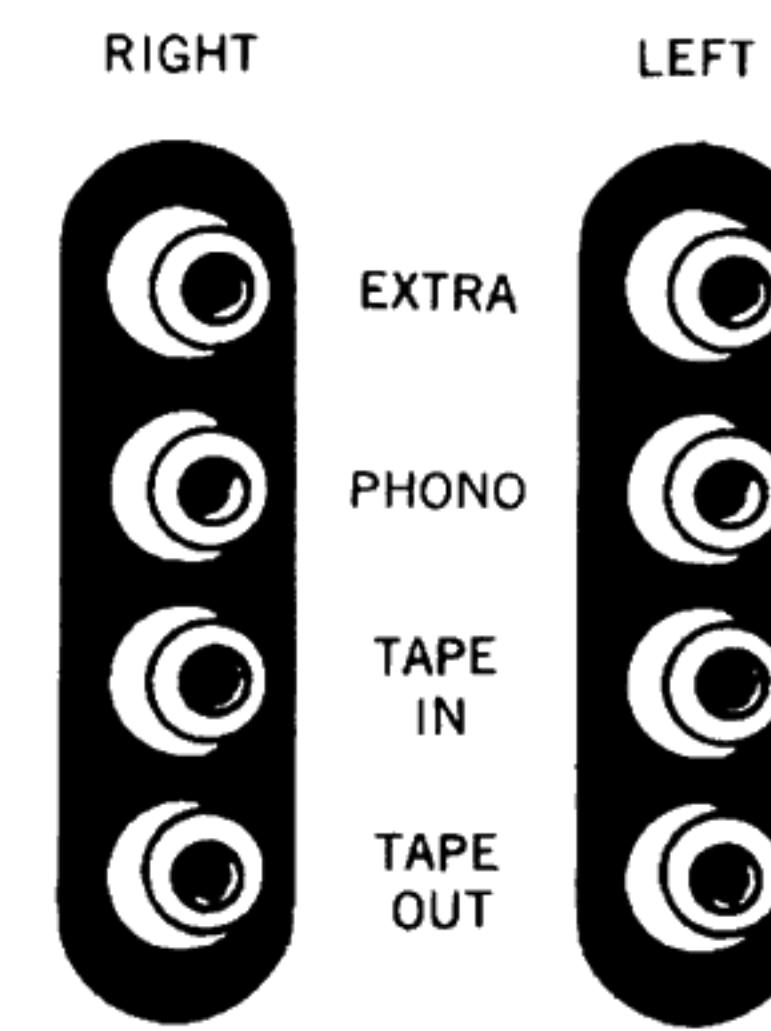

Connect an audio cable from the Left channel **TAPE OUTPUT** on the tuner-amplifier to the left input of the tape recorder. Repeat for the right channel. Some tape recorders have both a high level (or tuner) input and a low level (or microphone) input. Use the high level input for all connections from the tuner-amplifier. If there is any question, refer to the recorder instructions and follow accordingly.

If you have a monophonic tape recorder, connect the Left channel **TAPE OUT** to the tape recorder.

## TO PLAY-BACK TAPE

(For Stereo tape recorders with their own playback pre-amplifiers.)

Connect an audio cable from the left channel output to the left channel **TAPE IN** input jack on your tuner-amplifier. Repeat for the right channel. In order to listen to the tapes switch the **TAPE** switch on the front panel to the **MONITOR** position.

If you are listening to a monophonic tape recorder, connect the tape recorder's output cable to the left channel **TAPE IN** input jack. Slide the **MODE** switch to **MONO** so that the sound can be heard over both speakers.

## TUNER OUTPUT

The **TUNER** jacks may be used either to supply a signal to a second tape recorder or to a separate stereo amplifier. This feature is extremely useful in connecting many sets of extension speakers, as the separate stereo amplifier can be used as a remote control center for the extension speakers.

## ACCESSORY OUTLET

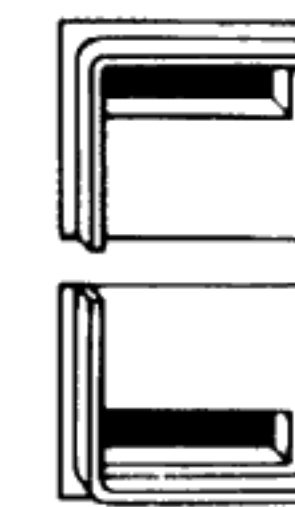

The accessory AC outlet on the rear panel is controlled by the front panel power switch. When the power switch is turned **OFF**, anything plugged into this outlet will automatically be turned off.

It is suggested that you **DO NOT** plug your record player into this outlet. If power to a record player is turned off before the change cycle is completed, a rumble-producing "flat spot" may occur on the drive wheel of the changer.

## HOW TO USE YOUR TUNER-AMPLIFIER AMPLIFIER SECTION

Your new Scott tuner-amplifier has a wide variety of controls. Yet, it is extremely easy to operate. Most of the controls are used only occasionally. The two indispensable operating features are the **INPUT** switch and the **LOUDNESS** (or volume) control. The former permits you to choose between different sources, such as phono or tuner. The latter allows you to vary the overall loudness to suit your taste. You will become familiar with these immediately.

### MODE SWITCH

#### MODE

##### STEREO

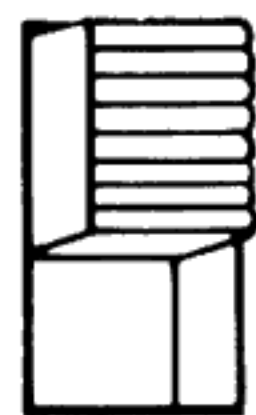

##### MONO

**Stereo** — If you are primarily interested in stereo program material, the switch will usually be in this position.

**Mono** — If a stereophonic cartridge is being used to play monophonic records, use this position. It automatically combines the outputs from the left and right channels of the cartridge into a single mono-

phonic signal. In the process of combining the two channels, noise and rumble present in the original record, and noise caused by vertical motion in your stereo cartridge is cancelled, resulting in much clearer reproduction of your mono records.

This position is also used when playing all other monophonic sources.

### BALANCE SWITCH

Scott's patented stereo balancing system makes it easy to detect and correct any differences in the loudness between channels brought about by room acoustics. It makes no difference what program material you use to check balance. It can be FM or Phono, but must be **MONO**.

#### BALANCE

##### BAL. R



##### NORM.

##### BAL. L

The balancing system is activated by the **BALANCE** slide switch. With the music playing at full room volume, slide the switch to the **BAL-L** position. Listen to the sound for a moment and then slide the switch to **BAL-R** and listen for a moment. Now slide the switch back to **NORM** position. If necessary, repeat the procedure to determine whether the sound is louder on one channel than the other.

If it is determined that the sound is lower in one channel simply move up the **LOUDNESS** control for the lower channel until it matches the louder channel.

**CAUTION:** BE SURE THAT THE **BALANCE** SWITCH IS IN THE "NORM" POSITION WHEN THE ADJUSTMENT IS COMPLETED. IF THE SWITCH IS IN EITHER "BAL" POSITION, NO SOUND WILL COME FROM THE ALTERNATE SPEAKERS.

### BALANCING THE SYSTEM

Whether the system is being used stereophonically or monophonically, it is important that the sound from the two speaker systems be of equal volume. They may differ because of room acoustics, differences in speaker efficiencies, differences in output between the two channels of a stereo cartridge, speaker placement, discrepancies between the two channels in the original program material, etc.

#### LOUDNESS

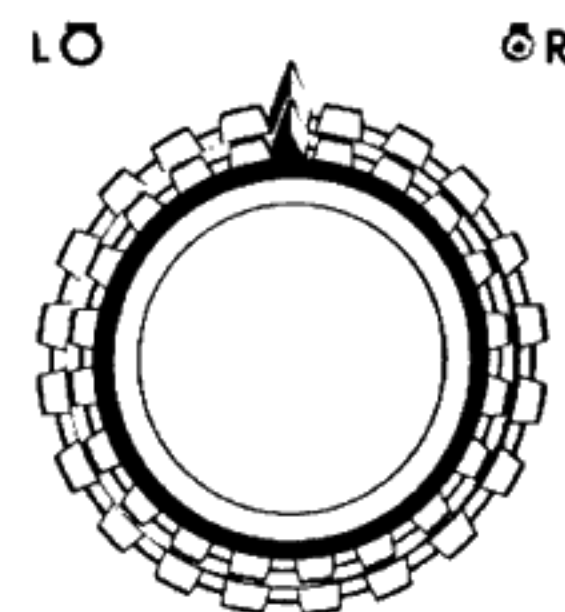

The **LOUDNESS** control on your tuner-amplifier is a clutched control. It is actually two separate controls, one for each channel, locked together by friction. If one channel is louder than the other, it is easy to correct this problem. Firmly grasp the knob that controls the channel that was louder in the balancing test. With your other hand, rotate the knob on

the softer channel slightly clockwise. Recheck the balance by the method described below. Repeat the procedure until both channels are equal. You can now use the clutched control as a regular volume control. The loudness between channels will be equal over a wide range of rotation.

### TAPE SWITCH

To listen to the playback of recorded tape, simply slide the **Tape** switch to the **MONITOR** position. In this position it automatically bypasses the **Input** switch and permits you to listen to tape only. When you are finished with the tape, immediately return the switch to the **NORMAL** position. Otherwise you will be unable to hear any other program material.

#### TAPE

##### NORMAL

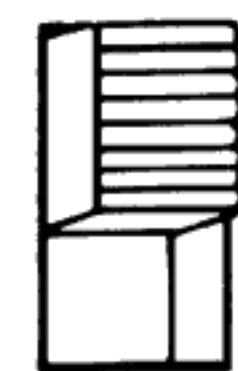

##### MONITOR

If your tape recorder incorporates a separate playback head (with playback electronics) it is possible to listen to the recording a fraction of a second after it is made as a quality check. Let us assume that a recording is being made off-the-air. The **Input** switch will be in the **FM** position. With the **Tape** switch in the **NORMAL** position, the system will be playing the actual broadcast. With the switch moved to **MONITOR**, the system will now be playing the tape recording of the broadcast just after it has been recorded. By moving the switch back and forth it is possible to hear whether the recording is equivalent to the actual broadcast.\*

\* Only for recorders with separate record and playback heads.

## INPUT

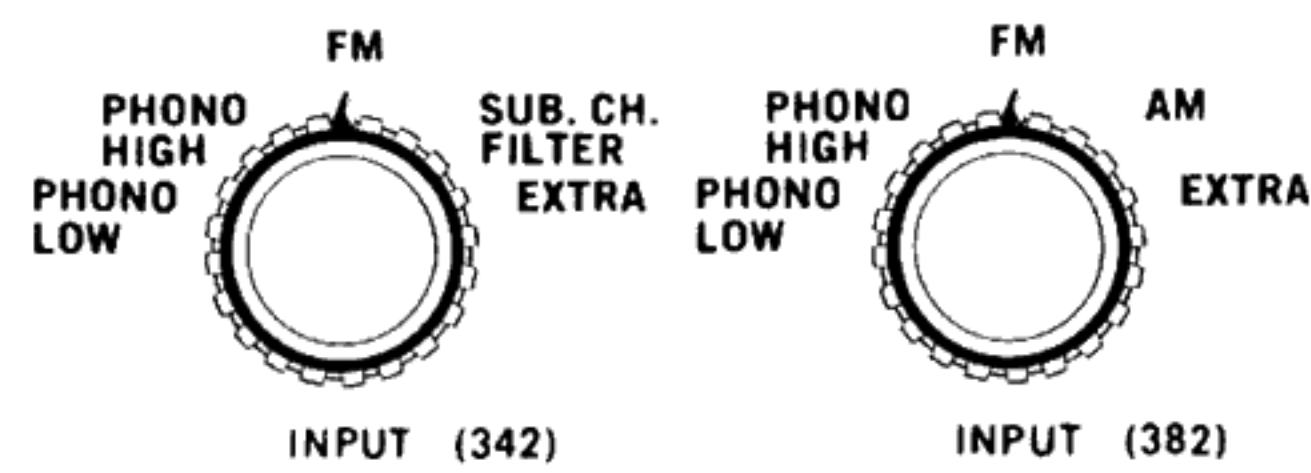

The **Input** switch allows you to select whatever program material you wish to hear. For instance, if you wish to listen to a record played on your record player, the **Input** switch should be turned to **Phono** position.

The **Sub. Ch. Filter** is designed to be used when listening to noisy FM Stereo broadcasts.

## TONE CONTROLS

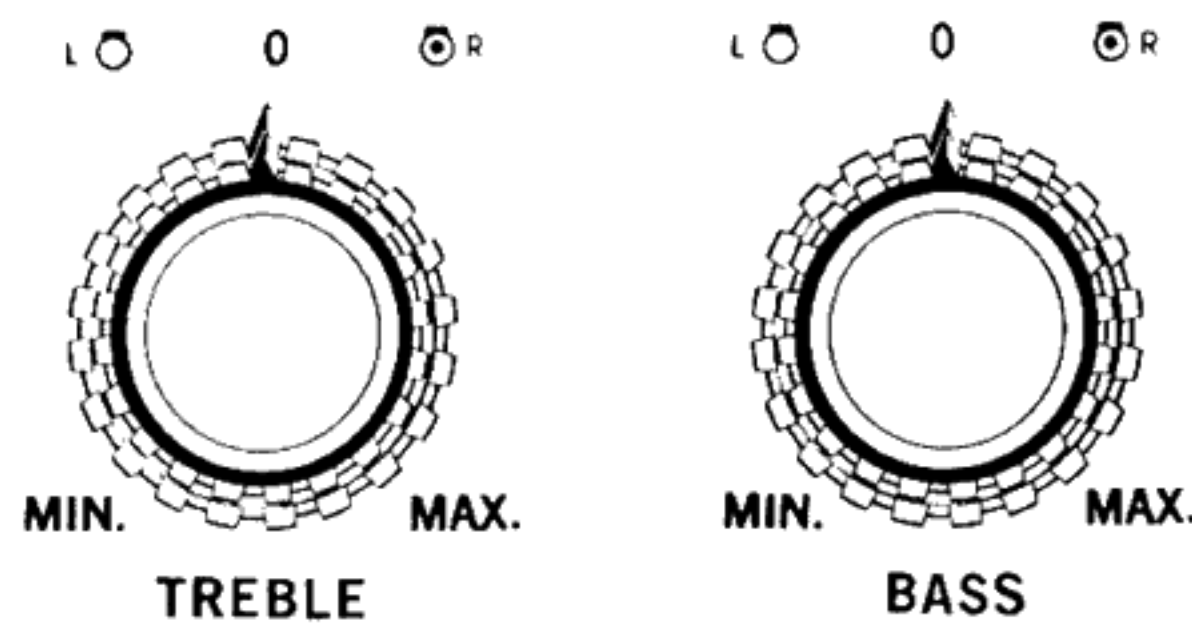

The tone controls used in your amplifier are actually two separate controls (one for each channel) held together by friction. When you turn the treble control, you are changing the high frequencies on both channels. If you desire to modify one channel only, firmly grasp the knob that affects the channel you do **NOT** wish to change. Then turn the other knob as you wish.

These controls modify the sound to suit the user's taste, the room acoustics, and the program material being used. H. H. Scott provides separate controls for each channel to permit you to adjust for differences between speakers, and differences due to placement of the speakers in the room. The **BASS** control modifies the low frequencies while the **TREBLE** control modifies the high notes. Rotating the controls clockwise causes an increase in the amplitude of the frequencies, while rotating counter-clockwise causes a reduction.

Feel free to use these controls as you see fit. You are the one who must be satisfied with the over-all sound, and the tone controls are the principal way of seeing that you are. However, boosting the treble will accent surface noise on phonograph records and hiss on tapes, while boosting the bass will emphasize record player motor noise.

## MONOSPAN

By having separate tone controls, Scott makes it possible for you to simulate stereophonic sound on your older monophonic records. Simply turn up the **TREBLE** control on the left speaker and turn down the one for the right speaker. Then turn up the **BASS** control for the right speaker and turn down the one for the left. The amount of boost or cut is strictly a matter of taste. You will find that the higher pitched instruments like violins and flutes appear to be coming from the left speaker, while the deeper ones such as drums and cellos appear to be on the right. This will add to your enjoyment of monophonic material.

## NOISE FILTER

### NOISE FILTER



It may be necessary to turn down the treble controls, too.

If the surface noise of a phonograph record, or the hiss of the tape recording, becomes objectionable, the **Scratch** filter is the answer. By sliding the switch to the **IN** position, most of the high frequency noises will be sharply reduced. If you are listening to especially old 78 RPM records,

### SPEAKERS

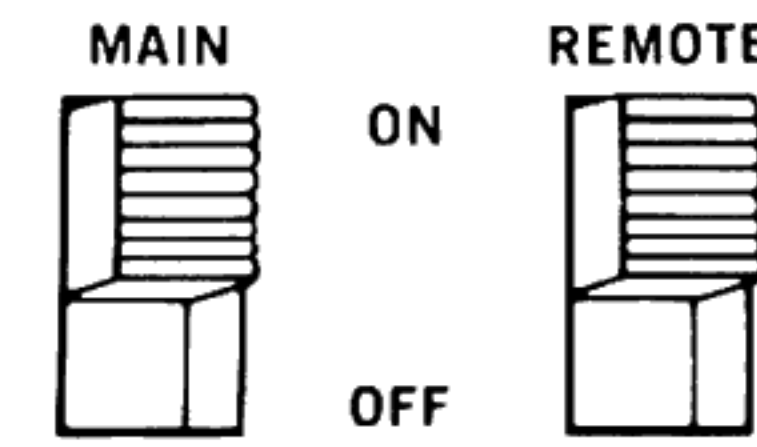

speakers will be turned off without affecting the signals to the **Low Level Output** jack. In the **Main** position, both the **Low Level Output** jack and the loudspeakers will be operative. In the **Remote** position the **Low Level Output** and any speakers connected to the remote speaker terminals will be operative.

### SPEAKERS

This switch is designed to complement the front panel **Low Level Output**. When using headphones, you may wish to turn off the loudspeakers to avoid feedback to a microphone or disturbing others in the room. By sliding the **SPEAKERS** switch to the **OFF** position, all signals to the main

## LOW LEVEL STEREO OUTPUT JACK

### PHONES



When the headphone plug is inserted in the front panel **Low Level Output** jack, the **SPEAKERS** switch on the front panel can be switched to **Off** position. This will completely cut off sound from the loudspeakers, permitting use of the **Low Level Output** jack. If desired, the speaker and the **Low Level Output** jack may be used simultaneously.

A low level, low impedance output jack is located on the front panel. This jack will accept the standard three conductor phone plugs found on most popular low impedance stereo headphones. When using this jack, make sure that the plug is pushed in firmly.

### POWER



### POWER SWITCH

A separate **POWER** switch is provided. This permits you to leave all the front panel controls in their normal operating positions without having to reset them.

## TUNER SECTION

To listen to the Tuner section of your stereo tuner-amplifier, turn the **INPUT** switch to either of the tuner positions.

Most of the front panel controls described in the previous section on the Amplifier part of your complete unit are operative in helping you get the most from the tuner part. For example, the loudness, tone, scratch filter, etc. controls are all useful and you should become familiar with them if you are not already.

### TUNING IN AN FM OR AM STATION

FM is capable of providing wide frequency response, low distortion, and a significant amount of noise rejection. SCOTT's wide band AM, incorporating a unique Automatic Variable Bandwidth circuit, provides AM reception of the highest order. However, to take full advantage of these capabilities, it is essential that the station be tuned exactly. To insure accurate tuning, SCOTT includes an accurate tuning meter on the receiver.

### TUNING METER

The precision tuning meter shows the strength of the incoming FM signal. Turn the tuning dial slowly and stop when the pointer has reached maximum. The meter reading will vary from station to station depending



on the amount of signal present from the transmitter. The reading may even vary from day to day on the same station due to atmospheric conditions. Just tune to the point where the meter reads highest and you will be set for best reception.

Occasionally you will note that the meter may swing violently back and forth. This indicates that an airplane is passing nearby. The swinging will stop once the plane has gone.

### LISTENING TO AN FM STEREO BROADCAST

The development of FM Multiplex broadcasting is one of the great breakthroughs in home entertainment. Your new Scott stereo tuner will provide the maximum in listening pleasure when used to receive one of these remarkable broadcasts. First, you must locate a stereo program. This can be done by referring to your newspaper or to the FM station's program booklet. A much easier way is to use the convenient built-in stereo indicator.

### SCOTT AUTO-SENSOR CIRCUIT

The amazing Auto-Sensor actually switches your tuner to stereo automatically when you are tuned to a station broadcasting in multiplex. If the station returns to normal monophonic operation, the tuner will automatically switch back to monophonic reception. You never have to think about resetting the controls.

To listen to a stereo broadcast with the Auto-Sensor circuit, turn the **INPUT** switch to **FM**. Tune across the dial slowly. When you locate a stereo signal, the pilot light behind the tuning dial will flash on and the tuner will instantly switch to stereo operation.

### LISTENING TO REGULAR FM MONOPHONIC BROADCASTS

The Auto-Sensor circuitry will instantly switch the tuner to receive monophonic programs if no stereo multiplex signal is present. It is not necessary to set the **MODE** switch for **Mono**. Simply leave the switch in the **Stereo** position, unless you want monophonic reception at all times.

You do not have to vary any control settings. The tuner automatically provides a monophonic signal at both outputs. Therefore, even though the program is monophonic, you will still hear sounds from both speakers without further adjustments.

### LISTENING TO FM WHEN SOME INTERFERENCE IS PRESENT

A major advantage of FM is its ability to reject extraneous signals that would cause static or noise over AM. FM Multiplex stereo broadcasting is more susceptible to noise pickup than is regular FM monophonic transmission. Nevertheless, your highly sensitive Scott tuner will reduce potential problems to an absolute minimum.

No tuner will make a poor transmission sound like a good one nor can it completely overcome the difficulties arising from an inadequate antenna. Therefore, if you hear noise, distortion or static on a particular program, first make sure of the following:

- 1) The noise, distortion, or static may be on the record or tape being played by the FM station. The wide frequency response of your Scott tuner permits you to hear everything, both the good and the bad. The difficulty may be at the station.
- 2) Check your antenna system. It may not be positioned properly for best reception. You may be picking up reflections from buildings or hills which lead to multipath distortion (called ghosts on TV). The cure is a better, more directional antenna. Re-read the section on antennas near the beginning of this book. If you desire more information on antennas, write to the Technical Service Department (see address on last page).
- 3) The **NOISE FILTER** may be used to reduce interference on a stereo broadcast. Although this will reduce the high frequency response, it will eliminate most objectionable noise.

## APPENDIX

### MULTIPLE SPEAKER MATCHING FOR TRANSISTOR AMPLIFIERS

A number of schemes have been proposed for matching multiple loudspeakers to transistor amplifiers.

What it all boils down to is that we must not permit the impedance of the loudspeaker system as seen by the amplifier to drop below 4 ohms. The simple solutions using resistors or series-parallel hookups are not suitable for more than one extra pair of loudspeakers. When it is desired to have more than two loudspeakers connected to any one channel at one time it is best done by means of a transformer. Not just any transformer will do, however. Most transformers sold for this purpose were designed for public address systems, carrying speech frequencies and do not have enough inductance to operate properly at the lower frequencies required for good high fidelity music reproduction. There is, however, a way around the problem. We can use the secondary winding of a good quality output transformer designed for tube-type hi fi amplifiers. These are readily available at parts jobbers or can be purchased as spare parts from a hi-fi manufacturer. Any good quality transformer that has 4 ohm, 8 ohm, and 16 ohm taps will do the job.

If the transformer has terminals for the primary winding, it is best to tape over them so that they will not be accidentally used or short-circuited; likewise, if the transformer has wire leads, it is best to cut off the primary wires completely. We should end up with four terminals or wires — a common terminal, and a terminal each for the 4 ohm, 8 ohm and 16 ohm taps. Mark the 16 ohm tap with the letter "A", the 8 ohm tap with the letter "B", the 4 ohm tap with the letter "C", and the common tap with the letter "D". This is shown in the sketch below.

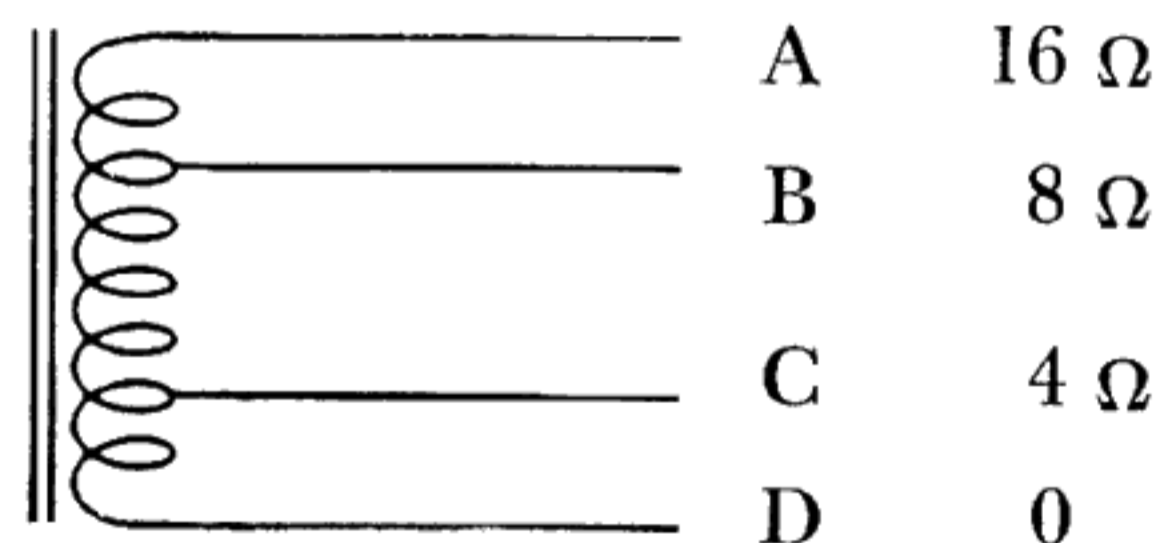

Determine how many speakers are to be connected in parallel to each channel. It is desirable that they all be of the same nominal impedance. The table below shows the maximum number of speakers of each impedance that may be connected to a channel and shows the transformer terminal combinations to be used for making such connections.

| Amplifier | Speakers | Max. No.<br>16 Ω in<br>Parallel | Max. No.<br>8 Ω in<br>Parallel | Max. No.<br>4 Ω in<br>Parallel |
|-----------|----------|---------------------------------|--------------------------------|--------------------------------|
| A-D       | C-D      | 8                               | 4                              | 2                              |
| B-D       | A-B      | 12                              | 6                              | 3                              |
| B-D       | B-C      | 24                              | 12                             | 6                              |
| A-D       | B-C      | 50                              | 25                             | 12                             |

It is suggested that if a transformer having lead wires is used, wire nuts be used for making the connections, as it is convenient and avoids short circuits.

If it is desired to switch off one or more speakers in the string, this may be done by the simple usage of a toggle switch at each speaker. If it is desired to reduce the volume level at certain individual speakers, an L-pad of the appropriate impedance should be used.

**A FINAL WORD**—If you have any questions concerning the operation of this instrument, a letter to the following address will bring a prompt, personal reply.

**TECHNICAL SERVICES DEPARTMENT**  
**H. H. SCOTT, INC., 111 Powdermill Rd., Maynard, Mass.**







## SCOTT TWO YEAR GUARANTEE

All H. H. SCOTT professional quality audio components are guaranteed for two years from the date of sale to the consumer. This guarantee covers repair or replacement of any part found by the manufacturer, or his agent, to be defective. The unit must be delivered to an authorized Scott dealer, or authorized Scott Warranty Service Station, or to the company itself, within two years from the date of purchase from an authorized Scott dealer.

Furthermore, on units delivered to an authorized Scott dealer, an authorized Scott Warranty Service Station, or to the factory, during the first 90 days after purchase from an authorized Scott dealer, H. H. Scott, Inc., will absorb any associated labor cost. For the remainder of the guarantee, the customer will be charged only for the labor cost.

The above guarantee does not apply to vacuum tubes, piezo-electric, or semi-conductor devices, or plug-in units, which items are covered by the guarantee or the original manufacturer.

To validate the guarantee, the enclosed warranty card must be returned to H. H. Scott, Inc., within ten days from date of purchase from an Authorized Scott dealer.

This guarantee covers only units which have not been subject to misuse or accident, damaged by use in violation of instructions furnished by us, or which have not been repaired or altered outside of our factory or its authorized Service agencies. Any unit which has the serial number removed or defaced will also be exempted from this guarantee.

Should your Scott unit require service at anytime, please do one of the following, whichever is most convenient for you:

1. Return the unit to the dealer from whom it was purchased. Many Scott dealers have a stock of replacement parts and excellent repair facilities.
2. Take the unit to one of Scott's Authorized Service Stations. These Service Stations are specialists in our equipment. Many are factory trained and all are kept constantly up to date on our equipment.

3. Write to the Customer Service Department, H. H. Scott, Inc., 117 Powdermill Road, Maynard, Massachusetts, describing the difficulty in detail. *Be sure to include the model and serial number of your Scott unit and list all associated equipment.* If it is determined that the unit should be returned to the Factory, you will be sent the proper forms including a return authorization label. Pack the equipment well (in original specially designed container if possible) to prevent shipping damage. Ship via Railway Express Agency or U.P.S. prepaid (do not ship via parcel post) and insure for full value.

**IMPORTANT!**— Please contact the Customer Service Department at the factory before returning any equipment. In many instances the trouble may be elsewhere and our customer service experts may save you much time and effort if they have a full account of the difficulty. Further, any equipment returned to the factory without a return authorization label may be subject to many delays in servicing.

Your unit will receive prompt and careful attention. If on inspection we find the unit to be defective, repair will be made at no cost to you if the unit is returned within 90 days after date of original purchase. Should the unit be returned to us after 90 days from date of purchase, but before 730 days have elapsed, again if we find the unit is defective, H. H. Scott, Inc., will provide a replacement of any such defective part (except vacuum tubes, piezo-electric, semi-conductor devices, or plug-in units which items are covered by the guarantee of the original manufacturer). If you wish us to install a part, you will be billed only for labor costs involved.

This guarantee supersedes all previous Warranties of H. H. Scott, Inc., and is in lieu of all other warranties expressed or implied. We reserve the right to change or improve our products without incurring any obligation to modify products previously manufactured.

Your new H. H. Scott equipment is the finest of its type. It was skillfully designed, carefully manufactured and thoroughly tested. Your choice of our equipment will result in many years of pleasure.

