

Capacitor Sounds 2 - Output Buffer and Twin-Tee Notch/Preamp.

Updated & expanded March 2003.

Original version Pub. Electronics World September 2002

Many capacitors introduce distortions onto a pure sinewave test signal. In some instances this distortion results from the unfavourable loading which the capacitor imposes onto its valve or semiconductor driver. In others, the capacitor generates the distortion within itself.

Most properly designed power amplifiers measure less than 0.01%, or 100 PPM distortion when sinewave tested at 1 kHz. Such small distortions are believed inaudible, yet users often claim to hear distortions from these amplifiers when listening to music.

As a result many articles can be found on Internet and in specialist magazines, claiming to have identified differences in sound, between different capacitor types. Not by measurements, but by listening tests, having upgraded a capacitor. This has led to a retrofit market supplying 'better' audio grade capacitors, at substantially elevated prices compared to mass market types.

A common subjectivist claim is that oil impregnated paper capacitors sound better than film types in valve amplifiers. Others claim that a PET capacitor sounds 'tubby' while a Polypropylene sounds 'bright' and that all ceramics sound awful. Naturally these claims have no supporting measurements.

A year ago, a particularly acrimonious letters page dispute arose in Electronics World regarding capacitor distortions. It seemed some of the issues raised could only be resolved by providing proof positive, that many capacitors do cause distortion. I offered to perform some comparative distortion measurements.

Commitment honoured.

To measure the distortion level for most capacitors, a very low distortion generator complete with a matching low output impedance, low distortion, buffer amplifier must be used. An easily replicated, low cost, extremely low distortion test generator was described in my last article. **Ref.1** This equipment can be used to measure amplifier distortions as well as capacitors.

This article describes a matching very low distortion, low output impedance, buffer amplifier needed to generate a pure sinewave voltage across a test capacitor. Having a near 600 Ω input impedance this buffer amplifier could equally be used with many commercial generators as well as with my design. see **Fig.1**

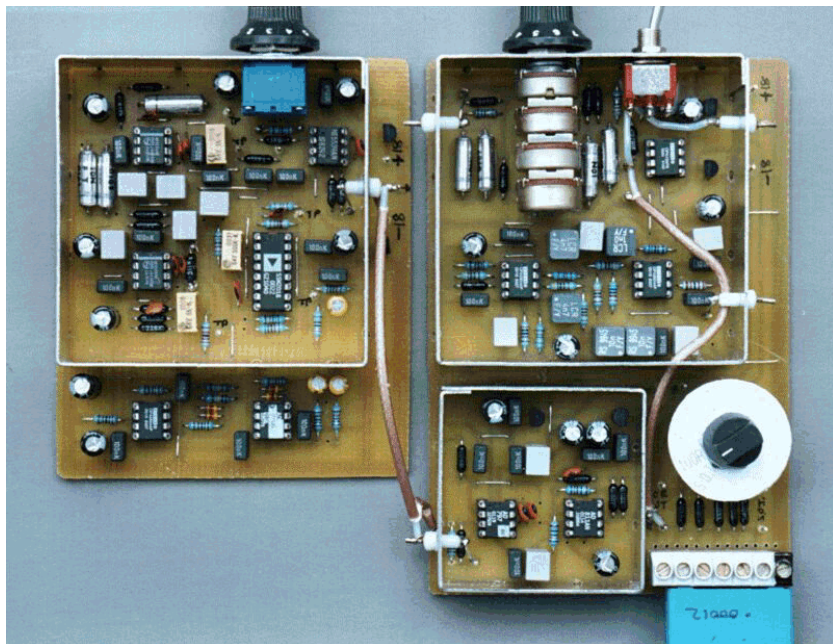

Fig 1) Very low distortion, low output impedance buffer amplifier, with passive Twin Tee notch filter, bandpass filters and 40 dB gain preamp printed circuit board (right).

This arrangement used with my low distortion 1 kHz oscillator (left), can measure capacitor distortions down to -130 dB.

Switchable source impedances from 100 Ω to 100 k Ω , together with the test jig as shown, facilitates measuring different value capacitors to a common test standard.

Notch Filter.

To facilitate measuring capacitor distortions using low cost instrumentation, the 1 kHz test fundamental should first be attenuated some 65 dB in a passive Twin Tee notch filter. Reducing the dynamic range to be measured.

Using a typical 3 volts test signal, this attenuated test fundamental plus distortion components, is reduced to a few millivolts. This small signal should be bandwidth filtered and pre-amplified by 40 dB, to allow measurement using a 16 bit computer soundcard or the 12 bit Pico ADC-100 converter.

An easily built, low cost buffer amplifier together with a notch filter/pre-amplifier, have been designed on a second PCB. Together with my 1 kHz test generator **Ref.1** these two provide a complete system able to measure distortions as small as -130 dB, 0.3 PPM or 0.00003%, below a 5 volts test signal.

To replicate common circuit drive voltages, this buffer should be able to generate up to seven volts RMS across a 1 μ F capacitor, fed via a 100 Ω current limiting source resistor.

Test Requirement.

Perhaps you already have a low output impedance test generator. The simple method I used to decide when my equipment was suitable for capacitor distortion measurements, will determine whether your existing equipment can be used.

Using a 100 Ω source impedance, connect a 511 Ω resistor to ground. Increase the generator output so as to measure 3 volts or more across this 511 Ω using a DVM. Remove the DVM and perform a distortion measurement across the 511 Ω resistor.

If 1 PPM or less, replace the resistor by a good, nearly perfect 1 μF capacitor and without changing the generator output voltage, perform a distortion measurement across the capacitor. If less than 1 PPM the equipment can be used to measure capacitor distortions.

The best test capacitor for this would be either a COG ceramic or an extended foil/Polystyrene. These are not distributor items so are impossible to obtain in small quantities.

Next best is an extended foil and film Polypropylene, closely followed by extended metallised film electrodes with unmetallised Polypropylene dielectric. This last, manufactured by BC Components (Philips) is stocked by Farnell as part 577-881, 0.47 μF 250v. I used two of these, type 376 KP 0.47/250v connected in parallel. see **Fig.2**

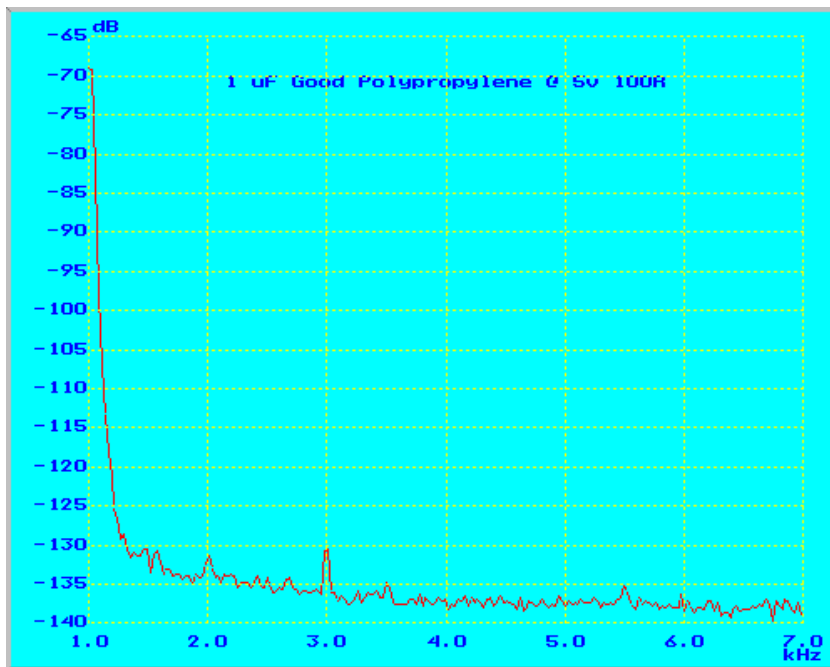

Fig 2) Plot of a near perfect 1 μF foil and Polypropylene capacitor tested at 5 volts in series with a 100 Ω source impedance. This plot includes not only any capacitor induced distortion but also that of my test system.

If you have a generator able to provide suitably low distortion into a 600 Ω resistive load, then my buffer amplifier may allow your generator to be used.

However it is important to note that the series input resistance seen by my buffer, some 1120 Ω inclusive of the 511 Ω R38, is essential for its low distortion. This total value should not be changed.

Buffer amplifier design.

The buffer amplifier must not itself contribute measurable distortions. Since distortion levels measured in good capacitors are -130 dB, 0.3 PPM or less, designing a suitable generator and buffer amplifier was no simple task. Designing a suitable buffer amplifier required almost as much development time as was needed for my low distortion oscillator. **Ref.1**

To drive 7 V RMS into a 100 Ω /1 μF capacitor combination using my generator, a gain of 2 buffer was required.

Many potential buffer amplifier configurations were breadboarded and rejected. While able to drive a resistive load, they were not able to develop a few volts across a 1 μF capacitor without distorting.

An open loop buffer IC, the Burr Brown BUF634P used with an OPA604 in the makers suggested circuit, worked well at low drive voltages or with smaller capacitors. Loaded with a 100 Ω /1 μF capacitor test load, it distorted at increased drive levels. By closing one link, this combination can be used on my PCB.

The most nearly suitable circuit I tried was described in the Analog Devices AD797 datasheet. With an AD811 as the output driver, this combination claimed to be able to drive a 600 Ω load to 7 volts RMS at 100 kHz with less than -109 dB distortion.

When breadboarded this design produced less distortion driving into my capacitive test load than did the BUF634P circuit. For minimum distortion however the circuit required critical matching of the impedances seen at both AD797 inputs. I was working to ensure suitable matching in November, when my only spare AD797 was damaged. Replacements not being available until February, I was forced to try other IC options. This combination of AD797/AD811 can be used in my PCB.

A low cost NE5534A worked quite well with this AD811 output stage but again required careful input matching to minimise distortion.. An OPA604 distorted at high drive, but the OPA134/AD811 worked best of all the combinations I tried.

Performance plots in this and my earlier article, were made using this OPA134/AD811 buffer amplifier.

With maximum drive into a 1 μ F load, the AD811 heats up so should be fitted with a small heatsink, half of Maplin RN69. To minimise noise pickup the circuit was screened using a small 50 mm * 50 mm Perancea solder mounting screening can and lid. To reduce heat build up, eight 8 mm holes were distributed around the box sides with twelve 6 mm holes in the lid.

Capable of more than seven volts output, I found this buffer circuit sufficient to measure distortions produced by capacitors from a few hundred picofarads up to 1 μ F, at 1 kHz. see **Fig.3**

Notch filter/pre-amplifier design.

To ensure minimal distortion of the test signal, a passive Twin Tee notch filter, with a nominal input impedance of 10 k Ω is used. To track the oscillator frequency, this notch is tuneable by some $\pm 10\%$ from its nominal 1 kHz frequency. Measuring source impedances greater than 1 k Ω , the loading of this passive notch filter is excessive. A high input impedance unity gain, low noise low distortion pre-amp can then be switched into circuit.

The notch filter is followed by four stages of low noise, low distortion, amplification and bandpass filtering. To minimise hum pickup, the filtered input is 50 dB down at 100 Hz. To reduce high frequency input into the measuring ADC, output is 20 dB down by 22 kHz. Amplified by 40 dB, harmonics from the 2nd to 9th are maintained flat within 0.5 dB

All measurements shown in this and the previous article, were made using this pre-notch filter/pre-amplifier as the input into my ADC-100 converter.

While care was taken to minimise noise and distortion in this notch filter/pre-amplifier, its contribution is included in all my test results. Using this notch filter/pre-amplifier, the distortion of my oscillator, built using AD797 IC's and the OPA134/AD811 buffer, driving 5v into my 100 Ω /1 μ F test capacitor load, measured -130 dB, or 0.3 PPM. see **Fig.3**

In most circuit applications, a capacitor is used either connected as shunt to ground or in series with the signal either to tailor the frequency response or simply block DC. Our test method should permit testing capacitors in either configuration.

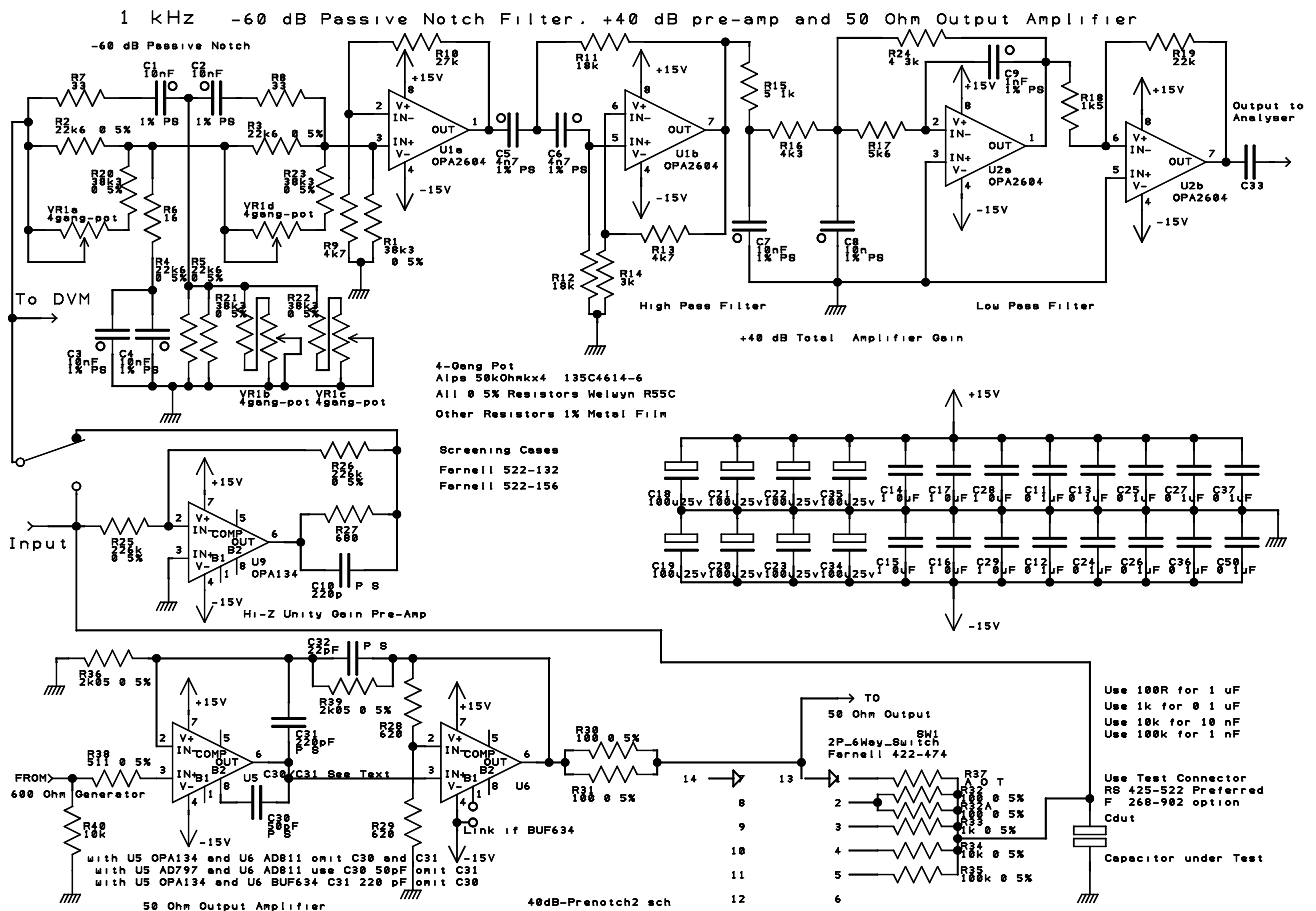

Capacitor jiggling.

To avoid soldering the capacitor under test, some form of test jig, permitting easy exchange of various size capacitors, is required. The test jig must provide very low resistance and secure connections to the test capacitor. The slightest connection insecurity introduces significant distortion due to the connection, not the capacitor.

I tried a number of spring contact terminal blocks. All but one required excessive capacitor lead lengths to ensure secure connections and that needed at least 5 mm wires. Farnell part 268-902. My PCB accepts this terminal block as well as the cage type. see **Fig.4**

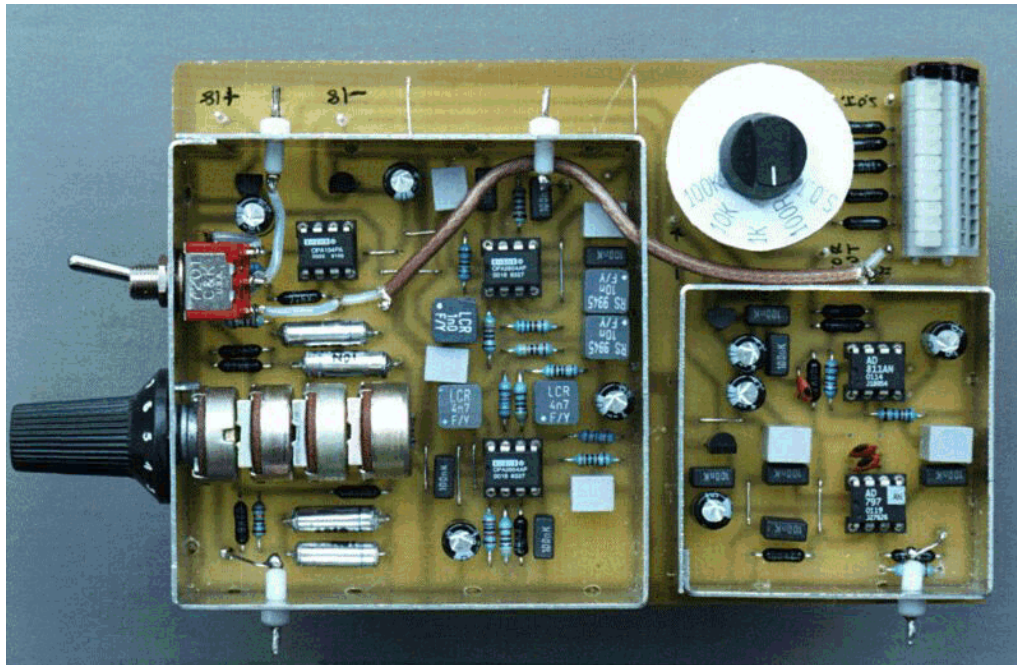

Fig 4) The PCB is double pierced so as to accept either the screw cage terminal test jig, as shown in figure 1, for capacitors with lead spacing up to 30 mm. Alternately this 'spring contact' terminal strip, accepts lead spacing up to 27.5 mm centres.

My test jig choice.

Ultimately for my own use I choose a 5 mm centres, cage type, screw terminal strip, able to measure capacitors having 4 mm long wires. RS part no 425-522.

Designed to accept thick wires, it easily accepts 2.5 and 7.5 mm spaced leads within its cage mouth. These cage terminals grip a wire tightly but without bending flattening or otherwise noticeably damaging the capacitor leads. This terminal strip 'jig' was used for all my 1 kHz/100 Hz capacitor distortion measurement plots.

The buffer amplifier/test jig shown can be used to test either series or shunt connected capacitor configurations. My preference is to shunt test, exactly as shown in the photo. The switchable current limiting resistor in series with the test signal, the capacitor being connected between signal and ground. see **Fig.1**

This provides two benefits:-

- 1)A good capacitor acts to slightly reduce any test generator harmonics, while a bad capacitor clearly shows much increased harmonic amplitudes.
- 2)The capacitor test voltage can be measured directly, using a high impedance meter attached to the DVM output test point. This test point measures the voltage at the input to the passive Twin Tee notch filter..

A test capacitor connected in series with the test signal, depresses the lower frequencies while slightly increasing higher harmonics, relative to the shunt connection.. The test voltage can only be measured by connecting a DVM directly across the capacitor. This DVM must always be removed before the capacitor can be tested.

Harmonic levels between the two methods differ by only one or two dB for the same capacitor voltage. A good capacitor looks good, and bad capacitors look bad, regardless of testing in the series or shunt connection.

By way of comparison, using a 1 k Ω source impedance, I plotted test results of a known bad, 0.1 μ F Metallised PET capacitor, measured in both series and shunt modes at 5 volts. In comparison the third harmonic distortion peak of a good 0.1 μ F Metallised PET capacitor tested at the same voltage, measures substantially lower, around -125 dB. see **Fig.5, Fig.6**

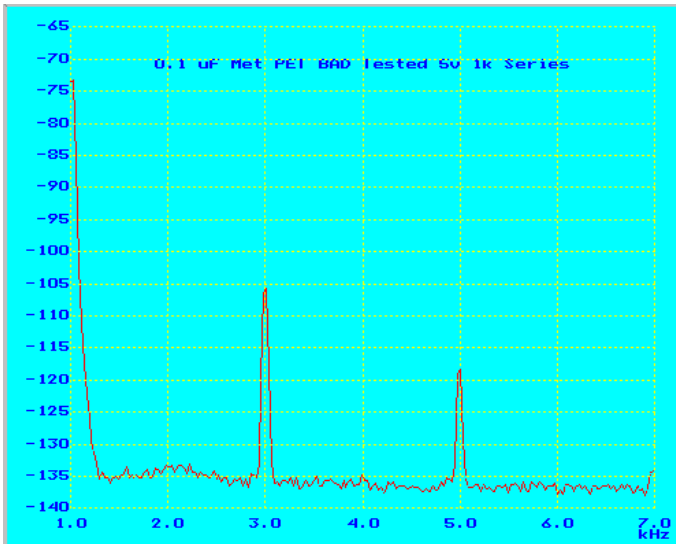

Fig 5) Distortion plot of a known 'bad' 0.1 μF metallised PET capacitor tested at 1 kHz with 5 volts across the capacitor, using the optional 'series mode' connection. The capacitor is in series with the test voltage, the 1 k Ω current limiting resistor, is to ground.

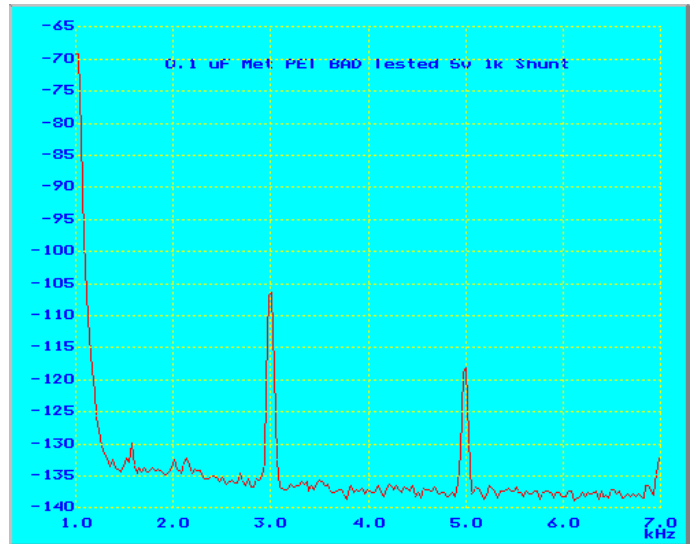

Fig 6) Distortion plot of the figure 5 capacitor and with the same 5 volts 1 kHz signal, using my standard 'shunt' connection. The 1 k Ω current limiting resistor in series with the test voltage, the capacitor connected to ground as in figure 1. Almost identical distortion was measured in both configurations.

Series tests.

To test in the series mode, the test capacitor and current limiting resistor are simply interchanged. The test capacitor is connected to the A.O.T resistor Vero Pins and the switch is set to the O.A.T position. The current limiting resistor is fitted to the test jig terminals, replacing the test capacitor shown in the figure. see **Fig.1**

Test Capacitor Source Impedance.

The buffer amplifier output switch provides selection of four values of current limiting, or source impedance resistors. In principle any resistance value can be used to test any capacitance. However this resistor value determines the maximum test voltage which can be developed across the capacitor as well as the test's sensitivity.

By way of illustration I plotted test results for a 220 pF Y5P 50v ceramic capacitor, Farnell 896-524, using each value of current limiting resistor in turn. At 1 kHz a 220 pF capacitor has an impedance around 720 k Ω . These clearly show that as the capacitor is more and more closely coupled to the generator output, its distortion peaks are much reduced. Tested with 1 k Ω the third harmonic peak had fallen to -121 dB and with 100 Ω to -127 dB. see **Fig.7, Fig.8**

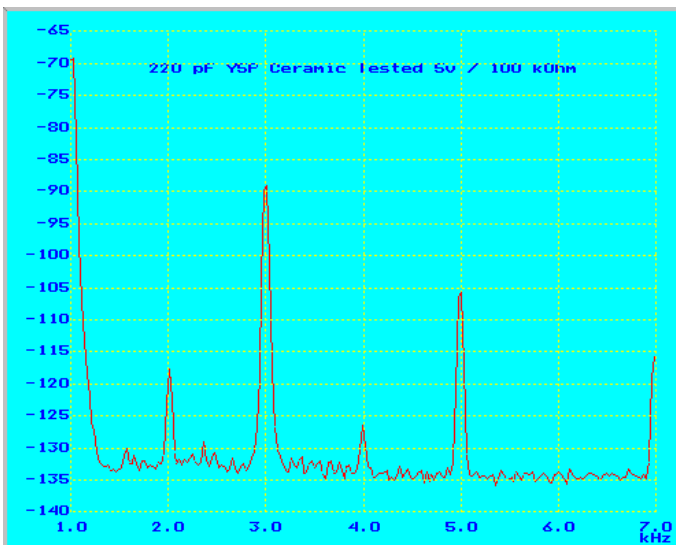

Fig 7) Distortion plot of a 220 pF Y5P disc ceramic capacitor tested using a 100 k Ω current limiting resistor and with a 5 volts 1 kHz test signal across the capacitor. Clearly shows significant distortion products when tested using this source impedance.

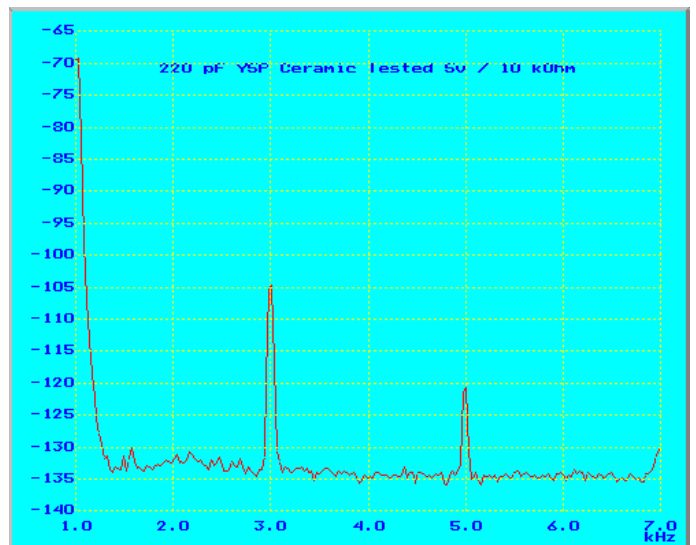

Fig 8) Distortion plot of the figure 7 capacitor, tested exactly the same except for the current limiting resistor, now 10 k Ω . Because the capacitor is more tightly coupled to the very low distortion test source, its distortions are partially decoupled, so appear much smaller.

For consistent test conditions, I would normally test such small capacitance values using the 100 kΩ, source impedance.

Using very low source and load impedances, makes even a badly distorting capacitor look relatively good. This is my main objection to the test method used by the CTL1 tester. see Appendix.

This is a measurement quirk, the capacitor still generates the same distortion currents, but the measurement cannot see them. Similarly when testing with a reduced test voltage, the distortion still exists but can be lost in the noise floor and so not seen.

From many measurements of known good and bad capacitors, I found that a compromise between these impedance extremes should be used. Using a 100 Ω current limiting resistor with a 1 μF capacitor gave the best and most consistent results. Good capacitors looked good and bad capacitors looked very bad.

Thus I would normally use the 100 kΩ source impedance when measuring test capacitors of 1 nF and below, 100 Ω source impedance for a 1 μF capacitor at 1 kHz, 1 kΩ source impedance for a 0.1 μF capacitor at 1 kHz, 10 kΩ source impedance for a 10 nF capacitor at 1 kHz and pro-rata for other values/frequencies.

Whether these measured capacitor distortions are audible or not depends on the capacitors location in the circuit, the subsequent gain of the circuit, capacitor voltage levels and whether the capacitor is inside a negative feedback loop.

I cannot determine that. My object was simply to prove absolutely, using easily repeatable methods, that many capacitors can and do distort a very pure sinewave test signal.

Intermodulations.

Is it not possible that any measurable capacitor distortion using a single tone test signal, say distortion greater than -110 dB, will be made many times worse, when subject to a multiplicity of signals ? Thus contributing notable intermodulation distortion.

Intermodulation distortion measurements of such capacitors using just two pure tones, 100 Hz and 1 kHz, do show a multiplicity of distortion products, almost regardless of dielectric. Similar intermodulation distortions have been measured in 'bad' metallised film capacitors, i.e. those which show significant distortion above -110 dB, using a single tone.

Testing good capacitors with the same two tones, no intermodulation products have been seen.

Comparing the single tone test in figure eight with the dual tone test in figure nine, we see distortion products around 2 kHz and 4 kHz in this dual tone test. They are not visible in the single tone test, even though both tests used the same capacitor, voltage levels and source impedance. see **Fig.8 Fig.9**

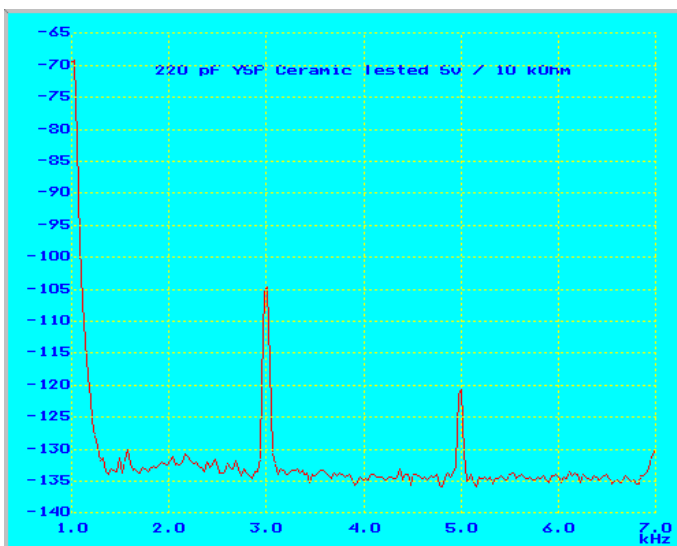

Fig 8) Repeated for convenience. Distortion plot of the figure 7 capacitor, tested exactly the same except for the current limiting resistor, now 10 kΩ. This single frequency plot was made using 10 kΩ for 1 kHz to allow direct comparison with the dual frequency plot of figure 9, made using 100 kΩ source for 100 Hz and 1 kΩ for 1 kHz.

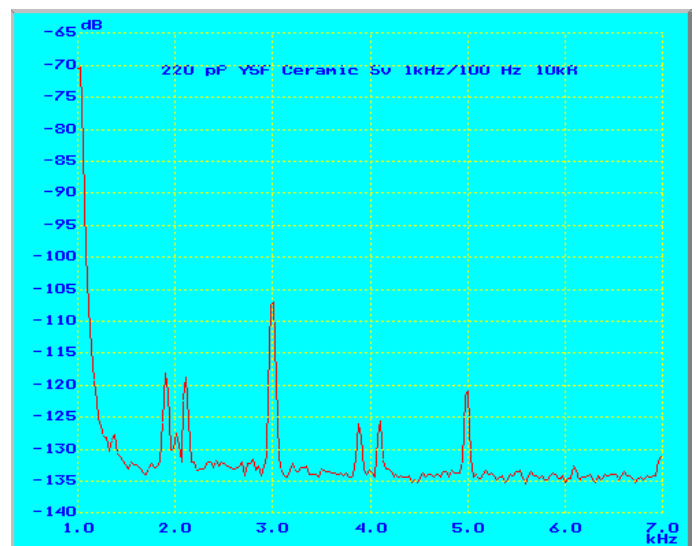

Fig 9) A dual frequency test, intermodulation distortion plot, 100 Hz and 1 kHz, of the capacitor shown in figure 8. Made using the same voltage and 1 kHz source impedance. Notice the appearance of new distortion products around 2 kHz and 4 kHz, not present when using the single test frequency. Bad metallised film capacitors exhibit similar distortions.

The level of distortions measured is naturally dependant on capacitor style, construction and capacitor AC and DC voltages.

Measurement equipment.

I have designed a second printed circuit board, similar to that housing my test oscillator. This board provides both the buffer amplifier and notch filter/pre-amplifier needed to complete a measurement system. The buffer amplifier section is designed so it can be easily separated from the notch filter/pre-amplifier if desired. see **Fig.10**

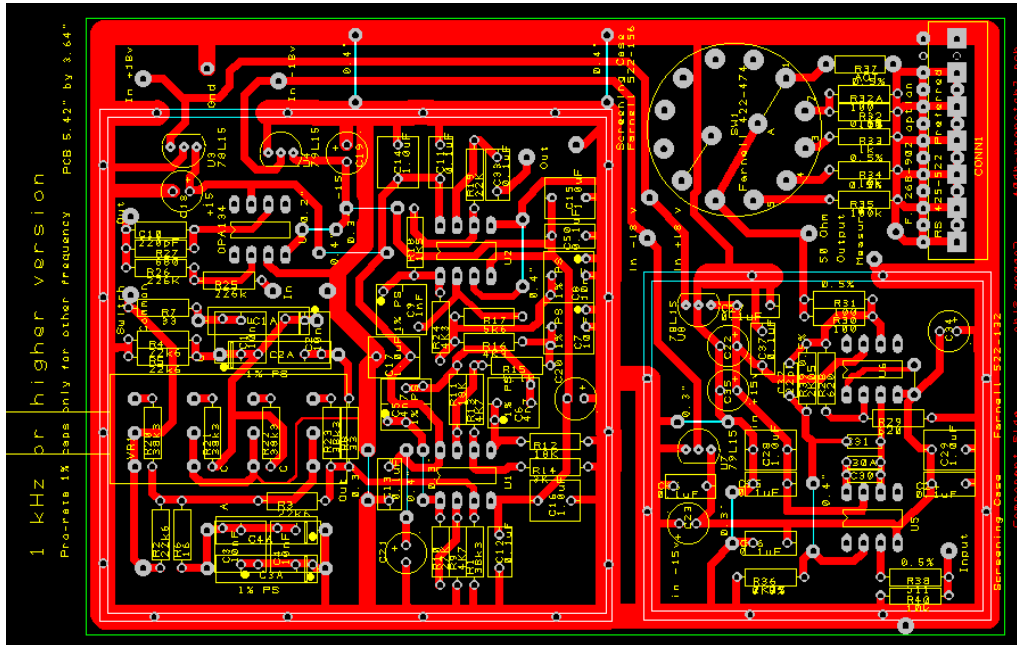

Fig 10) The version II printed board designed for my 1 kHz notch filter/pre-amplifier and low distortion buffer amplifier.

This arrangement was used for all measurement plots in this and my previous article. The board is multi-pierced to allow the widest possible choice of Twin Tee notch and bandpass filter tuning capacitors.

Testing Larger Capacitors.

Above 1 μF it is common practise to change to using electrolytic types, both tantalum and aluminium. To avoid overstressing such capacitors while maintaining similar test voltages, a reduced test frequency must be used. I developed an alternative buffer amplifier, able to drive up to 7 volts and 400 mA at 100 Hz, albeit with slightly greater distortion than for my 1 kHz design. Since electrolytic capacitors distort more than the lower value, better quality film and ceramic types this small increase in distortion is acceptable.

The printed circuit boards for my 100 Hz and 1 kHz generators are identical. The only component differences are the three low loss tuning capacitors, C1, C2, C3 which are 100 nF 1% for 100 Hz. One resistor value, R16 is 1 k Ω for 1 kHz but 0 Ω for 100 Hz. Pads for a wire link have been provided.

The 100 Hz notch and bandpass filters are also based on the 1 kHz design and need ten times capacitance values for 100 Hz. The board layout accepts the Vishay 100 nF 1% MKP capacitors, Farnell 303-8609, also 47 nF Farnell 303-8380. Smaller capacitances were provided using the same capacitor types used for the 1 kHz design. However as can be seen in the photo, the buffer amplifier section of this PCB layout is quite different. see **Fig.11**

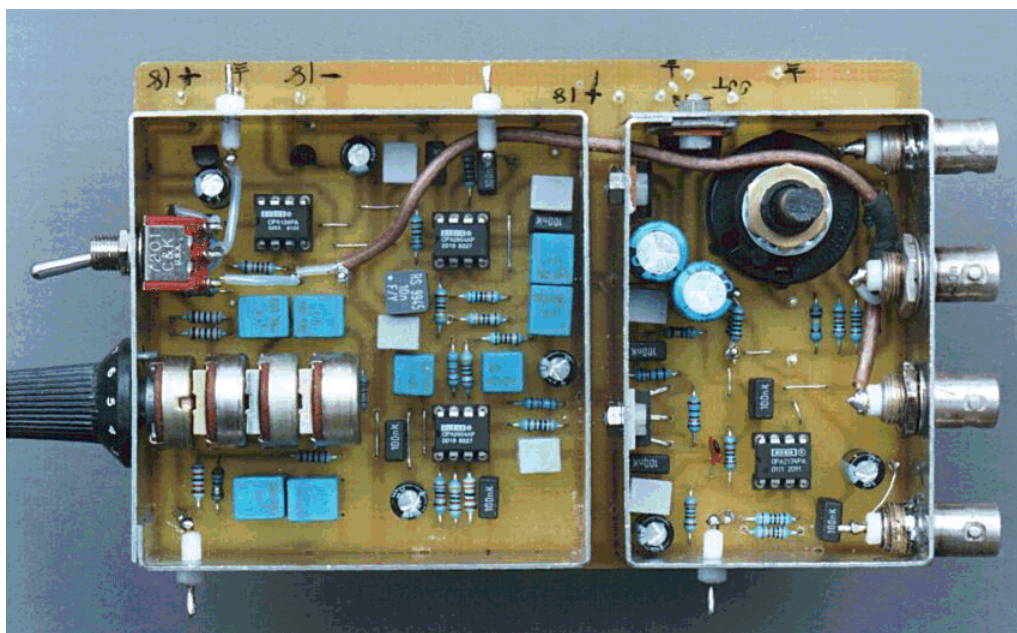

Fig 11) Photograph of the 100 Hz version printed board assembly complete with BNC sockets allowing use with Hewlett Packard test jigs or four separate coax cables.

The board is identical to figures 4 and 10, except for the tuning capacitor values and the higher output current buffer amplifier, designed around an Elantec EL2099C amplifier. The full schematic and PCB layout for this 100 Hz version will be included in a future article.

Constructing the notch filter boards.

To provide a degree of notch filter tuning, a four gang variable resistor is needed, ideally it would be a well matched conductive plastic part. To fit within the screening case it cannot be larger than 18 mm diameter.

I could not find a suitable four gang conductive plastic potentiometer. Alps do list a more modest four gang carbon track design but again I did not find a supplier. Glancing through an old price list from Falcon Electronics. **Ref.2** I found a four gang 4*50 kΩ Alps potentiometer at £1.75, used by Falcon in active crossover filters.

I ordered five potentiometers for evaluation. Apart from being rather old stock needing cleaning and re-tinning of the terminal pins, they worked fine and all were ganged closer than 1 dB. I used these pots in both my 1 kHz and 100 Hz notch filter builds.

With the exception of this variable control, to minimise noise and distortion and for easy replication, all resistors used in the twin tee notch filter signal path up to the first amplifier input, used 0.5% Welwyn RC55C, seen as black in the photo. To save space the four 38k3 series resistors are mounted between the potentiometer and PCB, so are hidden in the photo.

These resistors use plated steel endcaps, which I prefer for reliable long term end contact stability. Many subjectivists claim non-magnetic endcaps are better. I do not subscribe to that belief.

Having emerged from the notch, the fundamental signal has been reduced to a few millivolts, so my usual 1% resistors can be used. Amplified by 40 dB, the maximum output signal is still less than 0.5 volts.

Low distortion, low noise IC's must be used in this amplifier circuit. In my tests I found the OPA134 worked better than the OPA604 for high input levels, but found the reverse when amplifying the tiny voltages output from the notch filter.

For my builds I used OPA134 for the high input impedance, high level, switchable pre-amp U9 and OPA2604 dual IC's for the low level amplifier stages U1, U2.

In each case my preferred IC choice is the first type listed on the schematic drawing.

To facilitate evaluating IC's I used Harwin turned pin sockets for each position.

Similarly for capacitors. Those used in the notch filter must be low distortion, and for the 1 kHz version, 1% COG ceramic or extended foil/Polystyrene types only should be used. At 100 Hz which requires 100 nF, such capacitors are not easily obtained. Foil/Polypropylene then metallised Polypropylene, in order of preference, can be used.

Capacitor Tests.

Having tested one capacitor of a make and type, what guarantee does this give about harmonic distortions generated by other similar capacitors in the same batch.?

In my view that depends totally on the method of manufacture and the particular dielectric used. For the audio perfectionist however, perhaps every signal path capacitor should first be distortion measured.

For example COG ceramic is probably the most stable, and most nearly perfect of all commonly used dielectrics. COG disc and multilayer ceramic capacitors do not rely on pressure contacts or metal spray connections onto their electrodes. One maker's products should measure consistently and with remarkably low distortion. Those from a different maker may measure slightly differently, but again should be consistent from batch to batch.

Polystyrene is another of the best performing capacitor materials. Capacitors made using the extended foil technique and with their lead out wires soldered directly onto the extended foil electrodes, should be consistently nearly perfect.

Distortions in capacitors made using metal spray end contacts to their metallised film dielectric electrodes, for any one film type, will vary more from maker to maker. Worse still, from my measurements, they can also differ considerably even within a small capacitor batch.

Some film capacitor makers however do seem remarkably consistent within a batch and from batch to batch. With other makers I have measured some 20-30 dB different harmonic levels, in quite small batches, even when the capacitors have been supplied taped to card strips.

Having provided a usable, repeatable test method and easily assembled, low cost test equipment, my next articles will explore which capacitor types produce the least harmonic distortion, according to capacitance value.

When possible I shall try to explain how different capacitor constructions can account for the harmonic distortion generated in the capacitor.

With so many capacitor suppliers available, I cannot provide a best buy list. This measurement hardware, which allows repeatable capacitor distortion tests, I feel should be more than sufficient.

My next article will discuss capacitors having values up to 10 nF and soundcard FFT measurement software available on Internet.

References.

- 1) Capacitor Sounds part 1 C.Bateman Electronics World July 2002
- 2) Quad Ganged 50k Linear Alps Pots. Falcon Electronics. Norfolk. 01508 578272
- 3) Harmonic testing pinpoints passive component flaws. V.Peterson & Per-Olof Harris. Electronics July 11, 1966.
- 4) CLT1 Component Linearity Test Equipment data sheet. RE Instruments AS. Copenhagen.
- 5) Understanding capacitors - Aluminium and tantalum C.Bateman Electronics World June 1998 p.495.

Other measuring methods.

In the sixties, engineers at Ericsson believed that non-linearities in capacitors and resistors could be detected. They measured the level of third harmonic distortion generated in a component subject to a very pure sinewave test signal. **Ref.3**

Non-linearities were believed to result from badly ground resistor spirals, poor electrical contacts and non-linear materials. At that time poor contacts, especially in capacitors were commonplace. Fortunately today, with improved techniques, poor contacts in capacitors are now quite rare.

Their original non-linearity detector design produced low distortion test signals at 10 and 50 kHz. Third harmonic distortion generated by the component under test was passed through bandpass filters for measurement. Subsequently the 50 kHz test frequency was dropped and a commercial instrument, the CTL1 component linearity tester, was produced by Radiometer of Denmark. **Ref.4**

To accommodate the range of component impedances and test voltages needed, a low distortion output transformer was used. Having seven adjustable tapings, it was used to tightly couple the instrument to the component under test. Component impedances from 3 Ω to 300 k Ω could be directly measured, using source impedances from 0.05 Ω to 500 Ω respectively.

When testing lower impedance capacitors, the CTL1 datasheet which I still have, claimed to be able to output 0.58 A maximum. Resulting in a maximum test voltage around 100 mVolts at 10 kHz testing a 100 μ F capacitor. In my view this is not sufficient to reveal the true characteristics of such an electrolytic.

Today an updated version can be obtained from Danbridge A/S, Denmark, a specialist manufacturer of capacitor test instruments.

Some specialist audio suppliers quote distortion levels for Electrolytic capacitors, measured using the CTL1 meter. Because of the capacitance values measured and the 10 kHz test frequency, usually these results are based on extremely small test voltages, which often seem to be ignored in subsequent distortion claims, especially regarding usable dynamic range attained.

Such small test voltages will not harm the capacitor and will reveal any shortcomings in the metallic connections used in an electrolytic capacitor. However in my experience, today these are at such low level as to be unimportant.

Most important and relevant to audio in my view, are the inherent distortions which result from the electrolytic capacitor's diode characteristics. This diode characteristic is easily measured. **Ref.5**

From my test measurements at 100 Hz and 1 kHz, I find significant and measurable distortions when testing electrolytics, using voltages above 0.5 volts, but less so at very low test voltages.

This is exactly the result to be expected from consideration of the constructions used to manufacture these capacitors.

Extremely tight coupling between the test capacitor and the linearity tester is implicit in the CLT1 equipment design. From my early work measuring capacitors, I found it necessary to loosen this coupling in order to clearly reveal anomalies, now found in many modern capacitors.

By trial and error measuring known good and bad capacitors at 1 kHz, I found that 100 Ω in series with a 1 μ F capacitor provided the best compromise between measuring current and capacitor voltage. Adjusting this resistance value according to the capacitors impedance, at the test frequency used.

Soundcard FFT Software.

In this and my earlier article I used my Pico ADC-100 for all measurements, with the latest software downloaded from their site. However many readers will not have this ADC and wish to use a soundcard instead. A modern low cost PCI card with FFT software can provide improved capability, measuring even smaller distortions using my instruments, than is possible using the ADC-100.

The software I choose to use for the remainder of this series, is the 'Spectra 232Plus' FFT software. It can be downloaded from:- <http://www.telebyte.com/pioneer>

Should you have only an older ISA soundcard, some software may not work. One that will, is FFT.EXE, a DOS program by Henk Thomassen. This can be found on Internet, also the Elektor 96-97 software CD-ROM.

Users having a modern PCI soundcard will find a very large variety of programs, often available as freeware, on Internet. One site which links to some of the better packages is :-

<http://www.pcavtech.com/links/index.htm>.