

66
PREAMPLIFIER
&
CONTROL PANEL

INSTRUCTION BOOK

Q U A D

BRIEF OPERATING INSTRUCTIONS

Fit the PP3 battery supplied into the control panel.
Connect the preamplifier to the AC power supply with the mains cable supplied (fit suitable mains plug).
Connect power and signal cables (supplied with the amplifier) to the Quad power amplifier.
Connect input sources.

- Switch preamplifier on with the **ON/OFF** switch.
- Use the **CONTROL PANEL** to select the required sound source.
- Adjust **VOLUME** and **BALANCE** as required.
- Set **TILT**, **BASS STEP** and **FILTER** if necessary.
- When you have finished listening use the **STAND-BY** button to switch off.
- To switch on again, from **STAND-BY**, just press any **INPUT SELECTOR** button.
- The Quad CD player can be operated via the **CD FUNCTION** buttons.
- For more details on the operation of the 66 please refer to the main instruction book.

CONTENTS

	page
Introduction	2
Guarantee	2
Service	2
Accessories Supplied	3
Installation	3
Positioning The 66 Preamplifier	4
Connection To The Amplifier	5
Signal Connections	5
Operation	6
Control Panel	6
Preamplifier Control Functions	6
Tape Recording	8
CD Player Control Functions	9
Maintenance	9
Front And Rear View	10
Specification	11
Tilt, Bass Step And Filter Graphs	12

INTRODUCTION

The Quad 66 is a high quality preamplifier system with full remote operation. It comprises two units; a mains operated preamplifier to which the various sound sources are connected and a separate battery operated control panel incorporating all the main function controls for operating the preamplifier and Quad CD player, or any other remote control CD player using the same remote control language. If the battery fails the control panel can be directly powered from the preamplifier.

A display, on the preamplifier, shows all functions selected.

The preamplifier unit will accept inputs from seven sources; Disc, CD, Radio, A-V, Aux 1, Aux 2, and Tape (with off tape monitoring). A second tape recorder may be connected to the Aux 2 input and both the A-V and Aux 1 inputs have anti hum-loop circuitry.

The control panel has rotary Volume and Balance adjustment plus press buttons for Disc, CD-Play, Radio, A-V, Aux 1, Aux 2, Tape, Tilt (2), Bass Step (2), Filter (2), Cancel, Stand-By, Search (2), Track, Pause, Stop and Store.

The Stand-By facility enables the 66, and any equipment connected to the AC auxiliary outlet, to be switched on and off via the remote control panel.

GUARANTEE

The Quad 66 is guaranteed against any defect in material and workmanship for a period of twelve months from the date of purchase. Within this period we undertake to supply replacement parts free of charge provided that the failure was not caused by misuse, accident or negligence. Freight and labour costs are not covered unless by local agreement.

Within the UK this guarantee does not limit your statutory rights. A separate guarantee card is not supplied and your guarantee begins on the day of purchase.

SERVICE

If servicing is required it should be returned to the supplier, the distributor for the country of purchase or Quad Electroacoustics Ltd. A brief note should be enclosed giving your name and address and the reason for returning it. Quad offers same-day service from Monday to Friday except for bank holidays. Please contact us to make an appointment.

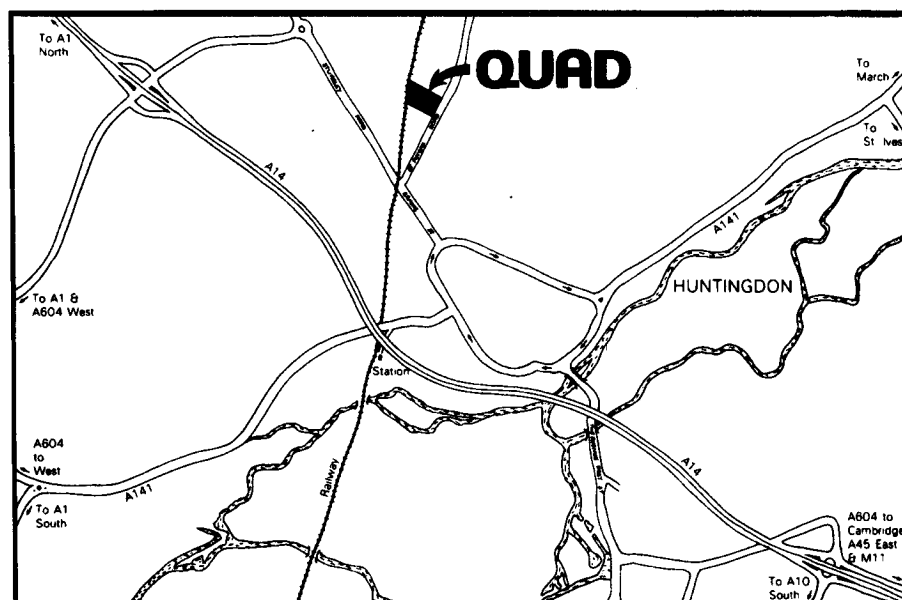

IMPORTANT

The original packing should be retained in case the unit has to be returned for service.

ACCESSORIES SUPPLIED

AC supply lead 2m long	Stock No. QESOE2A
AC output connector	Stock No. PPR0413
Alkaline PP3 battery (for control panel)	Stock No. N4022AA

INSTALLATION

Checking The AC Power Supply - The rating plate on the back of the preamplifier shows the AC supply voltage for which it is set.

If your AC supply is different from that indicated, ask your dealer or our Service Department to change the voltage setting for you.

Connecting To The AC power supply - The 66 is supplied with a 2m long AC supply lead to which a suitable plug should be fitted, as explained below:-

IMPORTANT - Fitting a mains plug.

The wires in the mains lead are coloured:

Brown - Live Blue - Neutral Green/Yellow - Earth

The Brown wire must be connected to the terminal marked L or coloured Red. The Blue wire must be connected to the terminal marked N or coloured Black. The Green/Yellow wire must be connected to the terminal marked E or coloured Green or Green/Yellow.

Note: The preamplifier must be protected by a 5A fuse when a 13A plug is used, or if another type of plug is used, by a 5A fuse either in the plug or adapter, or at the distribution board. If in doubt consult a qualified electrician.

AC Power output - The preamplifier is fitted with a switched AC auxiliary outlet for feeding other units in the system. Quad power amplifiers and tuners are provided with the appropriate interconnecting cables and the diagram overleaf shows how the units should be linked together. If required a spare AC output connector is provided which should be wired as shown in the diagram below.

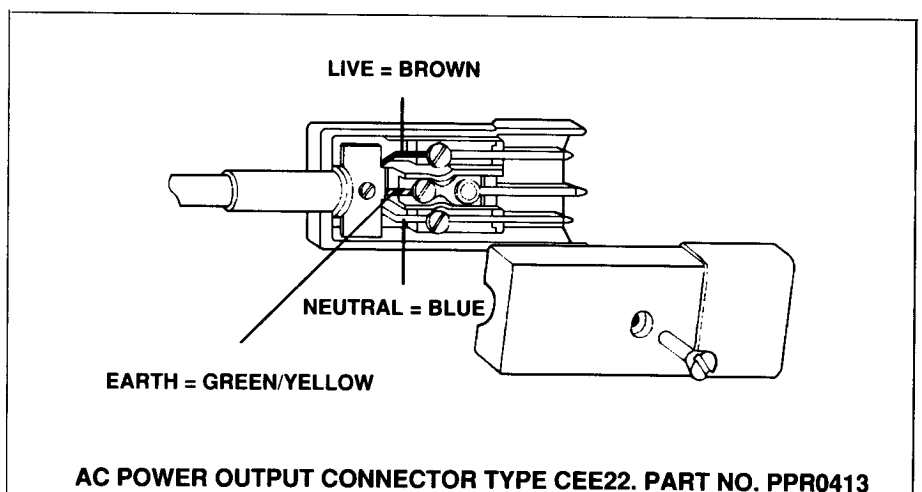

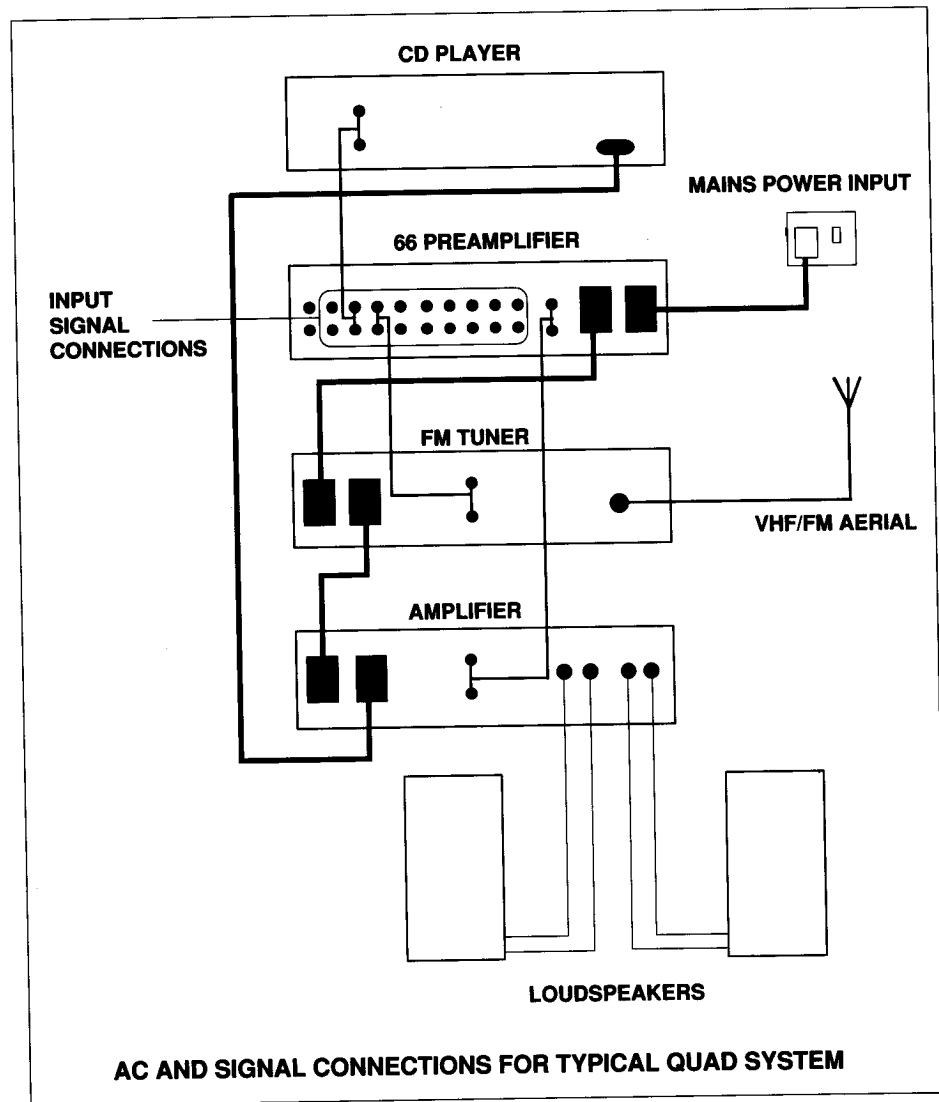

**POSITIONING THE
66 PREAMPLIFIER**

The preamplifier can be positioned free-standing or stacked with other components. Never place it in persistent direct sunlight or near any heat source.

Free Standing - If free standing, stand on a flat firm surface.

Stacked - Do not stand directly on top of a high power amplifiers, such as the Quad 606, as such amplifiers can generate a substantial amount of heat.

Warning: Do not place audio or video cassettes on top of the preamplifier because the magnetic fields produced by its mains transformer may effect the quality of the recording.

CONNECTION TO THE AMPLIFIER

The output of the 66 preamplifier is 0.5V suitable for all Quad transistor amplifiers (can be up to 1.5V max. for other amplifiers). Phono sockets are fitted and the cable supplied should be used to make connection to the power amplifier signal input connections.

SIGNAL CONNECTIONS

All input connections are clearly marked on the back of the preamplifier. Phono sockets are used for all inputs and an earth/ground terminal is provided for the Disc input if separate grounding is required.

DISC



DISC - The signal cable from the turntable should be plugged into the **DISC L** and **R** sockets. The signal cable will normally incorporate a separate earth/ground lead which must be connected to the **earth/ground terminal** marked with an earth/ground symbol.

The 66 preamplifier is supplied fitted with a disc input module suitable for most high quality moving magnet cartridges. Other modules are available with different input impedances and sensitivities for moving magnet and moving coil cartridges, or to provide a normal input for a tuner, CD player or similar source. Contact your Quad dealer or Quad direct for further details.

CD

CD - The signal cable from the CD player should be connected to the **CD L** and **R** sockets. This input is intended primarily for compact disc players but can be used as an auxiliary input for tuner or similar source.

RADIO

RADIO - For a Quad FM tuner or other tuners of a similar output level. The tuner signal cable should be connected to the **RADIO L** and **R** sockets.

AV

AV - Short for **Audio Video**. Will accept the output from a television set or video recorder with audio output connections. The signal cable should be connected to the **AV L** and **R** sockets.

This input is provided with an anti-hum circuit which prevents hum due to earth/ground loops.

AUX 1

AUX 1 - Auxiliary input for other input sources such as a second tuner, television tuner etc. The signal cable should be connected to the **AUX 1 L** and **R** sockets. This input is provided with an anti-hum circuit which prevent hum due to earth/ground loops.

AUX 2

AUX 2 - Auxiliary input for a second tape recorder, video recorder etc. Record and replay levels have been chosen to match most recorders currently available.

The signal playback cable should be connected to the **IN L** and **R** sockets and the record cable to the **OUT L** and **R** sockets.

TAPE

TAPE - Record and playback connections for tape or cassette recorders. Record and replay levels have been chosen to match most recorders currently available. The signal playback cable should be connected to the **IN L** and **R** sockets and the record cable to the **OUT L** and **R** sockets. Off tape monitoring is provided from this socket.

CONTROL IN - For future applications, eg external remote control sensor or use in multi room systems.

OPERATION

Switching On And Off - To switch on press the **ON-OFF** button on the front of the preamplifier. This has a sequential action so pressing it again will switch the unit off. Any equipment connected to the auxiliary AC outlet socket will also be switched at the same time.

When switched on the Quad 66 selects the last used input, volume tone and filter settings are as when the unit was switched off. Other inputs and functions can easily be selected using the remote control panel.

In normal use the preamplifier is left switched on and the equipment turned on and off using the **STANDBY** function on the control panel, see full details for **STANDBY** operation in the following section.

CONTROL PANEL

All input switching and operating functions are carried out from the control panel which can be used at the listening position or any other convenient position. It is not necessary to point the control panel directly at the preamplifier for correct operation.

The preamplifier display, shows which input is selected and the volume level, filter settings etc.

Operation is extremely simple and much more straightforward than it might first seem from the following instructions. We suggest that you experiment with the control panel functions so as to become familiar with its operation.

Note: If the volume control is rotated fairly rapidly, during programmes, the stepping action will introduce changes in level which may be heard as faint clicks. This is quite normal and will not affect the performance or quality of reproduction.

PREAMPLIFIER CONTROL FUNCTIONS (selected via control panel)

Stand-By - When you have finished listening simply press the **STAND-BY** Button. The volume is slowly reduced to zero and the preamplifier is set to the **STAND-BY** mode indicated by a green LED on the preamplifier front panel, all other display functions being extinguished.

Any equipment connected to the auxiliary power socket will also be switched off.

Selecting any input will switch the equipment on again and the volume will slowly increase from zero to its original setting. The volume level can be stopped at any point by pressing any of the control buttons with the exception of the CD functions, **STOP-STORE-TRACK-SEARCH**. Slight movement of either the **BALANCE** or **VOLUME** controls will have the same effect.

The 66 can safely be left in the stand-by mode for long periods but it is recommended to switch the main power off, with the preamplifier on/off switch, for extended periods; eg holiday breaks etc.

Input Selectors - Press the appropriate button for the function required; **DISC, CD-PLAY, RADIO, A-V, AUX 1, AUX 2, TAPE**.

The **CD** input selector button has two positions. Pressing the **CD-PLAY** button halfway selects **CD**, pressing all the way selects **CD-PLAY**.

When an input is selected the appropriate symbol will appear in the preamplifier display.

Volume - Turn the volume control knob until the required volume is obtained. The volume level is shown by the number of segments lit on the volume display oval on the preamplifier, the more segments lit the higher the volume setting. Each segment is approx. 4 dB at low levels and approx. 2 dB at high levels.

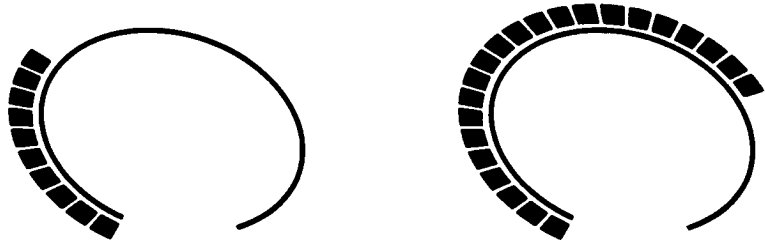

LOW VOLUME

HIGH VOLUME

Balance - Adjust the **BALANCE** control for correct interchannel sound balance. When only the thin centre line is lit the balance is set to its central position. As the control is turned clockwise or anticlockwise the balance is shifted from right to left which is indicated by the position of the segment lit just below the volume display oval on the preamplifier, the further this is from the thin centre line the greater the setting. Each segment is approx. 1 dB.



LH BALANCE





CENTRAL BALANCE



RH BALANCE

Tilt - This control operates exactly as its name implies by tilting the audio frequency response about a centre point. This alters the overall sound balance without introducing unwanted colouration. Six tilt positions are provided, three boosting treble and cutting bass, and three cutting treble and boosting bass (See graphs).

Pressing **TILT**  rotates the frequency response anticlockwise about its centre point and pressing **TILT**  rotates the frequency response clockwise about its centre point. Each position alters the response by approx. 1 dB at the frequency extremes.

The tilt positions are shown on the preamplifier display as they are selected.



Example; 1dB bass boost, 1 dB treble cut.

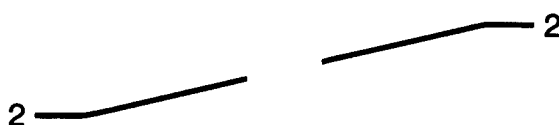

Example; 2dB bass cut, 2 dB treble boost.

Bass Step - Provides two positions of step cut at the low end of the frequency band to remove unwanted low frequency resonances without rolling off the extreme lower bass frequencies (See graphs). Pressing **BASS STEP ▼** steps through **S1** and **S2** positions, pressing **BASS STEP ▲** steps through from **S2**, **S1** to the flat response position. The step position selected is shown on the preamplifier display.

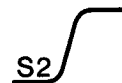

Filters - Provides two positions of steep cut at high frequencies to remove severe high frequency distortion without effecting the musical information, mainly used to reduce tracing distortion from records (See graphs). Pressing **FILTER ▼** steps through **F1** and **F2** positions, pressing **FILTER ▲** steps through from **F2**, **F1** to the flat response position. The filter position selected is shown on the preamplifier display.

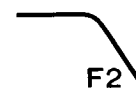

Cancel - Pressing this button returns all tone and filter settings to level positions. As this is a level response position no bass step, filter or tilt control positions are shown on the preamplifier display. Volume and balance levels remain as set.

TAPE RECORDING

Two tape recorders may be connected, one to the **TAPE** sockets and another to the **AUX 2** sockets. To make a recording it is only necessary to set the recorder to record. If required both recorders can be operated at the same time, in record only.

Recording - Select the source to be recorded (eg Radio, CD, etc) which will be heard through the loudspeakers as well as being fed to both the **TAPE OUT** and **AUX 2 OUT** sockets. Recording will commence as soon as the recorder is started. Monitoring (which is not possible on the **AUX 2** input) is achieved by pressing **TAPE**, and **TAPE** will be shown in the display. To return to listening to the source, press **TAPE** again, the **TAPE** display will go out.

Tape Dubbing - With two recorders dubbing is possible in both directions, as follows.

To record from AUX 2 to TAPE - Press **AUX 2**. Set the recorder connected to the **AUX 2** sockets to playback and the recorder connected to the **TAPE** sockets to record.

To record from TAPE to AUX 2 - Press **AUX 2**. A signal at **TAPE IN** is now fed directly to **AUX 2 OUT** for recording. Set the recorder connected to the **TAPE** sockets to playback and the recorder connected to the **AUX 2** sockets to record. As **AUX 2** is selected the speakers will play the signal at **AUX IN** which is the tape 'monitor signal' (off tape monitoring for a three head machine). To listen to the source signal press **TAPE**, and **TAPE** will be shown in the display. To return to monitoring press **TAPE** again, the **TAPE** display will go out.

Warning: Take care **NOT** to set **BOTH** recorders to record while **AUX 2** is selected as a feedback howl would be generated which could damage the loudspeakers.

Tape Monitoring - Off tape monitoring is automatically provided from any input, when **TAPE** is selected, via a recorder connected to the **TAPE** sockets.

CD PLAYER CONTROL FUNCTIONS

The Quad CD player (or any other remote control player using the RC-5 system) is controlled via the control panel. Full CD player operation is covered by its own instruction book but the main remote control functions, via the control panel, are as follows.

CD-Play - Press fully, to its second pressure position, to initially start play or to restart after pressing **STOP**. The CD player will start from track one.

Pause - Press for short interruptions. To restart press **PAUSE** again and play will start from the exact point where it was interrupted.

Stop - Press to stop play before the end of a disc.

Store - Used for storing tracks when programming the CD player to play tracks in a selected sequence. Select each required track number in turn, with the **TRACK < >** buttons, but press **STORE** after each track has been selected to enter it into the player's memory.

Search - Press, and hold down, **SEARCH >>** or **SEARCH <<** to find a later or earlier passage in a track.

Track - Press **TRACK >** or **TRACK <** to select a later or earlier track.

MAINTENANCE

No routine maintenance is required. If necessary the case can be cleaned with a soft brush or, for more stubborn marks, a slightly moistened lint-free cloth. In this case remove the mains plug from the supply socket. Do not use cleaning agents, solvents or abrasives.

Control Panel Battery Replacement - In normal use the battery fitted should last for approximately one year. A low battery will cause erratic operation and reduce the operating range.

To replace the battery turn the unit upside down and slide off the battery compartment lid as shown. Insert the new battery carefully and refit the battery compartment lid. The control is now ready for operation. Always use a leakproof battery (alkaline type PP3).

Powering The Control Panel Via The Preampfier - It is possible to power the control panel from the preampfier. This is useful if a replacement battery is not available or if you want the control panel permanently sited by the preampfier.

To do this slide off the battery compartment lid, pull out the 50 cm connecting lead and plug this into the DC power supply socket on the front right hand side of the preampfier. If operated in this mode for long periods it is advisable to remove the battery.

FRONT VIEW

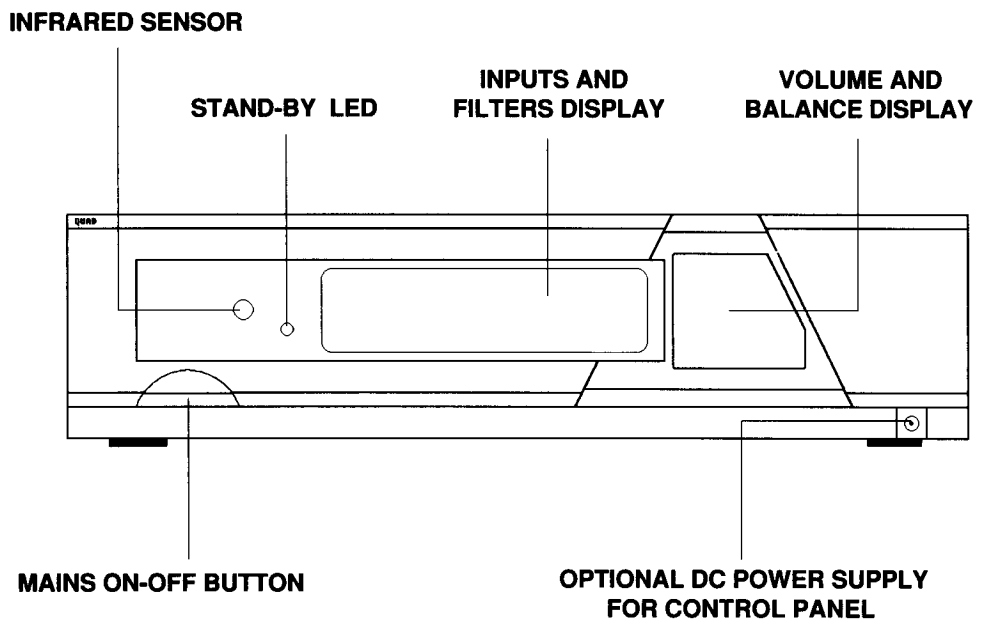

REAR VIEW

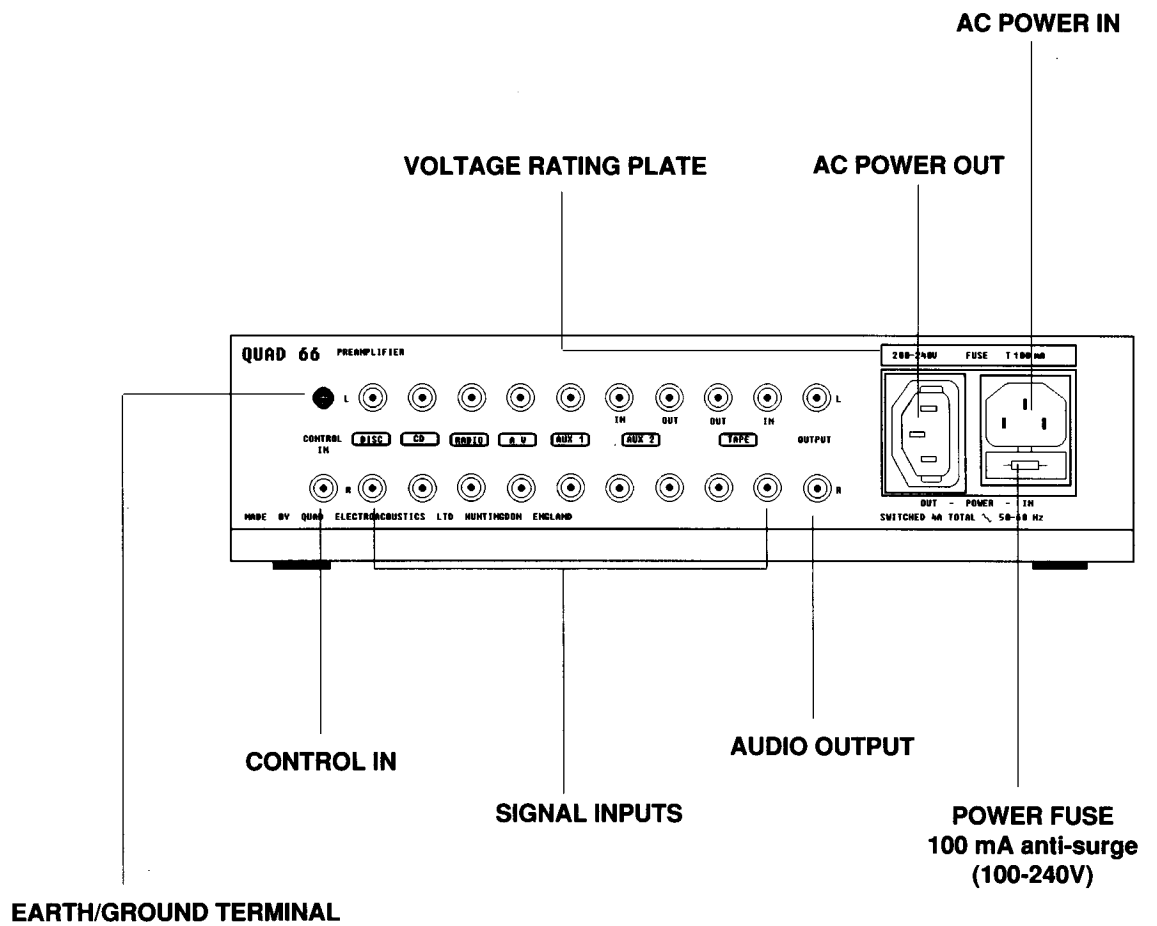

SPECIFICATION

Preamplifier

Operation:	Full function by infrared remote control panel.																																
Control Functions:	Volume, Tilt, Bass Step, Balance, Filters, Input selection and Standby. All operated from infrared remote control panel. No controls on preamplifier.																																
Inputs:	<table><thead><tr><th></th><th></th><th>S/N Vol Max.</th><th>Full Output</th></tr></thead><tbody><tr><td>Disc*;</td><td>3 mV/ 47 kΩ/220 pF</td><td>74 dB</td><td>90 dB</td></tr><tr><td>CD;</td><td>300 mV/100 kΩ</td><td>99 dB</td><td>105 dB</td></tr><tr><td>Radio;</td><td>100 mV/100 kΩ</td><td>93 dB</td><td>104 dB</td></tr><tr><td>A-V;</td><td>300 mV/ 33 kΩ (anti-hum)</td><td>93 dB</td><td>104 dB</td></tr><tr><td>Aux 1;</td><td>300 mV/ 33 kΩ (anti-hum)</td><td>93 dB</td><td>104 dB</td></tr><tr><td>Aux 2;</td><td>300 mV/100 kΩ</td><td>99 dB</td><td>105 dB</td></tr><tr><td>Tape;</td><td>300 mV/100 kΩ</td><td>99 dB</td><td>105 dB</td></tr></tbody></table> <p>(Noise figures 'A' weighted , dB below 500 mV output)</p>			S/N Vol Max.	Full Output	Disc*;	3 mV/ 47 k Ω /220 pF	74 dB	90 dB	CD;	300 mV/100 k Ω	99 dB	105 dB	Radio;	100 mV/100 k Ω	93 dB	104 dB	A-V;	300 mV/ 33 k Ω (anti-hum)	93 dB	104 dB	Aux 1;	300 mV/ 33 k Ω (anti-hum)	93 dB	104 dB	Aux 2;	300 mV/100 k Ω	99 dB	105 dB	Tape;	300 mV/100 k Ω	99 dB	105 dB
		S/N Vol Max.	Full Output																														
Disc*;	3 mV/ 47 k Ω /220 pF	74 dB	90 dB																														
CD;	300 mV/100 k Ω	99 dB	105 dB																														
Radio;	100 mV/100 k Ω	93 dB	104 dB																														
A-V;	300 mV/ 33 k Ω (anti-hum)	93 dB	104 dB																														
Aux 1;	300 mV/ 33 k Ω (anti-hum)	93 dB	104 dB																														
Aux 2;	300 mV/100 k Ω	99 dB	105 dB																														
Tape;	300 mV/100 k Ω	99 dB	105 dB																														
Outputs:	<table><tbody><tr><td>Amplifier;</td><td>500 mV/940Ω (1.5V max).</td></tr><tr><td>Aux 2;</td><td>300 mV/3k3Ω (tape record).</td></tr><tr><td>Tape;</td><td>300 mV/3k3Ω (tape record).</td></tr></tbody></table>	Amplifier;	500 mV/940 Ω (1.5V max).	Aux 2;	300 mV/3k3 Ω (tape record).	Tape;	300 mV/3k3 Ω (tape record).																										
Amplifier;	500 mV/940 Ω (1.5V max).																																
Aux 2;	300 mV/3k3 Ω (tape record).																																
Tape;	300 mV/3k3 Ω (tape record).																																
Distortion:	Worst case, any input 0.05%.																																
Residual Noise:	'A' weighted. Volume control at minimum -105 dB.																																
Frequency Response:	Any input except Disc \pm 0.3 dB from 15 Hz - 20 kHz. Disc RIAA flat within 0.5 dB from 30 Hz - 20 kHz.																																
Interchannel Balance:	\pm 0.5 dB volume control settings max. to -60 dB.																																
Filters,Bass Step and Tilt (+3 to -3):	See graphs.																																
Remote Control Interface:	Quad system with dedicated microprocessor.																																
Mains voltage:	100-120V or 200-240V (changed by links on PCB) 50-60 Hz: see rating plate on back of control unit.																																
Power consumption:	6 VA approx.																																
Fuse:	100 mA anti-surge, 100-240V.																																
Dimensions:	Width 321 mm; height 80 mm; depth 255 mm approx. (plus connectors)																																
Weight:	3.3 kg approx.																																

* Other options available.

Control Panel

System: Infrared. Dual system;
Quad system with dedicated microprocessor.
Philips RC-5 system for Quad CD Player or any other player using this system.

Controls: Rotary; Volume and Balance.
Press Button; Disc, CD-Play, Radio, A-V, Aux 1, Aux 2, Tape, Tilt (2), Bass Step (2), Filter (2), Cancel, Stand-By, Search (2), Track (2), Pause, Stop and Store.

Dimensions: Width 241 mm; depth 175 mm;
thickness 50 mm approx.

Weight: 0.76 kg (inc battery) approx.

Battery life: One year approximately with normal operation,
using an alkaline battery.

Battery type: Alkaline PP3 size.

GRAPHS

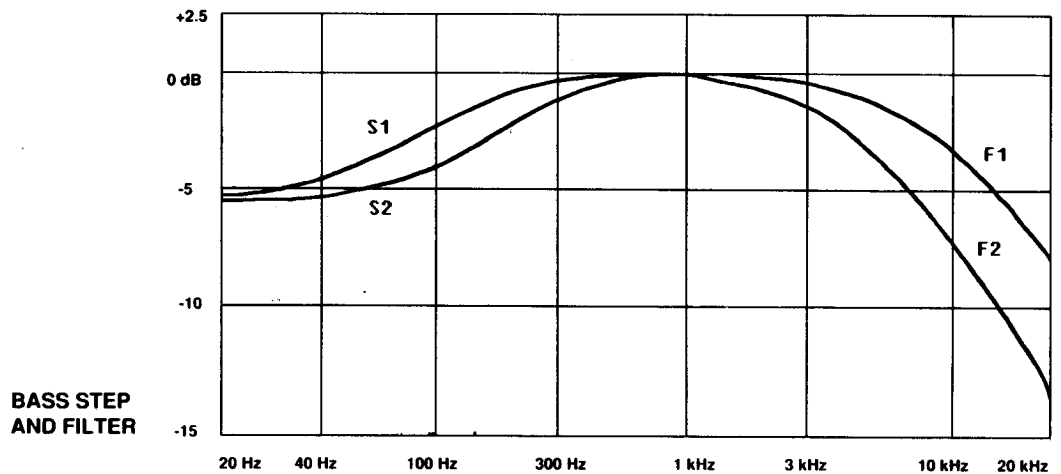
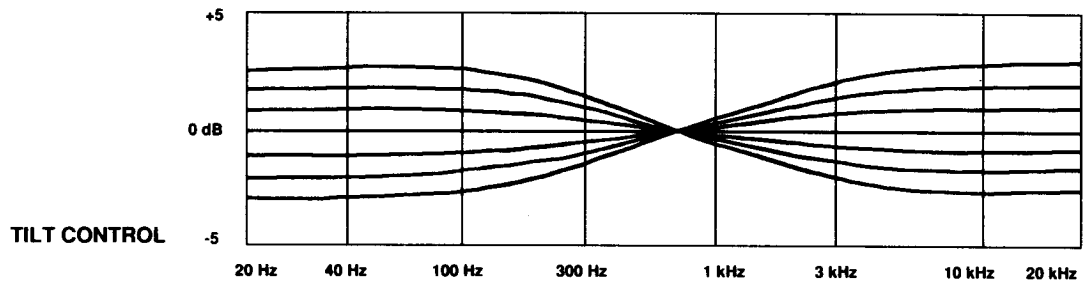

The right is reserved to alter performance and specifications as required.

This equipment complies with the radio interference requirements as laid down in EEC (European Economic Community) regulations.

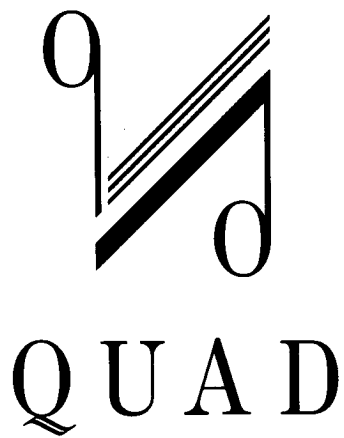

Quad Electroacoustics Ltd Huntingdon PE18 7DB United Kingdom
Telephone:0480 52561 Telex:32348 QUAD G Fax:0480 413403

QUAD is a registered Trade Mark