

**T  
E  
K  
T  
R  
O  
N  
I  
X  
  
I  
N  
C**

**TM 500 SERIES  
REAR INTERFACE  
DATA BOOK**

## **WARRANTY**

**All TEKTRONIX instruments are warranted against defective materials and workmanship for one year. Any questions with respect to the warranty should be taken up with your TEKTRONIX Field Engineer or representative.**

**All requests for repairs and replacement parts should be directed to the TEKTRONIX Field Office or representative in your area. This will assure you the fastest possible service. Please include the instrument Type Number or Part Number and Serial Number with all requests for parts or service.**

**Specifications and price change privileges reserved.**

**Copyright © 1975, new material copyright 1976, by Tektronix, Inc., Beaverton, Oregon. Printed in the United States of America. All rights reserved. Contents of this publication may not be reproduced in any form without permission of Tektronix, Inc.**

**U.S.A. and foreign TEKTRONIX products covered by U.S. and foreign patents and/or patents pending.**

**TEKTRONIX is a registered trademark of Tektronix, Inc.**

# TABLE OF CONTENTS

	Page
SECTION 1 INTRODUCTION	1-1
SECTION 2 APPLICATIONS INDEX	2-1
SECTION 3 REFERENCE INFORMATION	3-1
SECTION 4 BLANK PLUG-INS	4-1
SECTION 5 SIGNAL PROCESSORS	5-1
AF 501	5-3
AM 501	5-5
AM 502	5-7
AM 511	5-9
SECTION 6 DIGITAL COUNTERS	6-1
General Counter Information	6-3
DC 501	6-5
DC 502	6-11
DC 502 Option 7	6-17
DC 503	6-19
DC 504	6-23
DC 505/DC 505A	6-27
SECTION 7 DIGITAL DELAY UNITS	7-1
DD 501	7-3
SECTION 8 DIGITAL METERS	8-1
DM 501	8-3
DM 502	8-9
SECTION 9 FUNCTION GENERATORS	9-1
FG 501	9-3
FG 502	9-7
FG 503	9-11
FG 504	9-13
SECTION 10 LOGIC ANALYZER	10-1
LA 501	10-3

# TABLE OF CONTENTS (cont)

	Page
SECTION 11 MONITORS	11-1
MR 501	11-3
SECTION 12 PULSE GENERATORS	12-1
PG 501	12-3
PG 502	12-5
PG 505	12-9
PG 506	12-11
PG 508	12-15
SECTION 13 POWER SUPPLIES	13-1
PS 501/-1-2	13-3
PS 502	13-9
PS 503	13-13
PS 503A	13-19
PS 505	13-25
SECTION 14 RAMP GENERATORS	14-1
RG 501	14-3
SECTION 15 OSCILLOSCOPES	15-1
SC 501	15-3
SC 502	15-6
SECTION 16 SINE GENERATORS	16-1
SG 502	16-3
SG 503	16-7
SECTION 17 SWEEP GENERATOR	17-1
SW 503	17-3
SW 504	17-5
SECTION 18 TIME-MARK GENERATOR	18-1
TG 501	18-3
SECTION 19 TRACKING GENERATORS	19-1
TR 501	19-3
TR 502	19-5



# SECTION 1

## INTRODUCTION

The TEKTRONIX TM 500 line of modular instrumentation offers a new approach to electronic tests and measurements. In the past, monolithic signal sources such as function generators, sine-wave oscillators, pulse generators, ramp generators, and dc power supplies were often interconnected to DMMs, digital counters, and oscilloscopes for accurate electrical set-ups or measurements of frequency, period, pulse width, rise and fall times, ac-dc currents, and voltages. The front panel interconnections between these monolithic instruments can often become a confusing maze of wires and cables that obscures one's view of displays and interferes with convenient operation of front panel controls.

The promise of a better way is here today in the rear interconnecting interface system of TM 500 modular instrumentation. No one except TEKTRONIX offers such an easy-to-interconnect-and-use system.

In almost all TM 500 plug-in instruments, a duplication of front panel input and output connections appears on the plug-ins' rear edge circuit board connector. Since each plug-in connector is located inside the power mainframe on a common rear interface circuit board, plug-ins can be interfaced to "talk to" one another by way of interconnecting wires and cables easily installed by the user. *SEE FIGURE 1-1.* The number of possible interfacing schemes is only limited by the imagination. For example, the DM 502 DMM rear input terminals can be interconnected to an alongside PS 503A power supply for accurately setting power supply voltages. The DMM is not permanently connected to the power supply because a special INT-EXT front panel switch can be pressed; thereby returning the DMM to external full function capability. The operation of external circuits under test can now be measured by the use of standard probes or external wire connections. Another similar example could include interfacing the DC 505A universal counter-timer's dc trigger level output to the DMM for setting up the counter's channel A and B LEVEL controls. Accurate time measurements can now be made by setting the LEVEL control to DMM-displayed dc voltages representing 10 to 90% amplitude points for rise times and 50% amplitude points for pulse widths. The list can go on and on. However, sooner or later one gets around to asking the question, "How do I connect these instruments together to form my own viable instrument package?" This rear interface manual will suggest some ideas on interconnected systems and provide readily-accessible reference data so that you can easily design your own special purpose test set.

The APPLICATIONS INDEX describes some of the already-in-use interconnect application ideas. The section on BACKGROUND INFORMATION presents ways to obtain the most useful interface scheme. The MODULE DATA section provides signal input and output pin numbers for all TM 500 plug-ins.

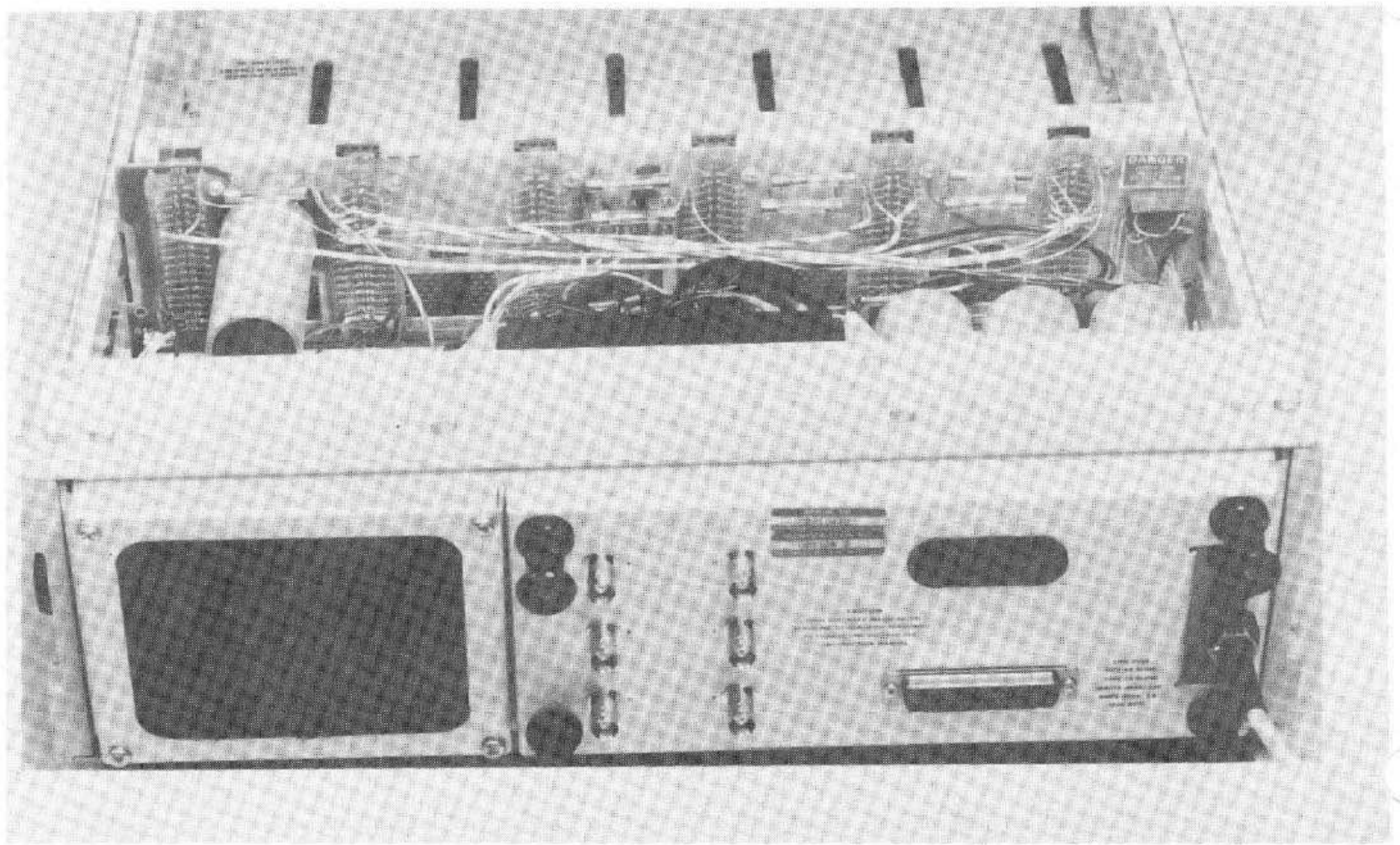

A TM 506 Option 2 mainframe interfaced by the use of special square pin connectors and cables.

*FIGURE 1-1*

By the way, if you have a new way to interconnect TM 500 not presently illustrated, just drop us a pencil sketch and a sentence describing your unique idea. Information should be addressed as follows:

TEKTRONIX, INC.  
P. O. Box 500  
Beaverton, Oregon 97077

TM 500  
M/S 39-185



# SECTION 2

## APPLICATIONS INDEX AND DESCRIPTIONS SECTION

### DESCRIPTION OF THE APPLICATIONS INDEX

The following APPLICATIONS INDEX was intended to be used as a quick reference guide to a more complete description of TM 500 applications. These applications fall into two generalized categories, consisting of (1) single instrument applications, and (2) multi-instrument applications. In the first case, most users are aware of generalized instrument applications. As a result, only the unusual single instrument applications are mentioned in the index. Single instrument applications requiring lengthy descriptions are located under the specific instrument MODULE DATA section. In the second case, multi-instrument applications may be either located in the MODULE DATA section under the primary important instrument or as an application note made available from the TEKTRONIX TM 500 Advertising Dept. See address below.\*

### APPLICATIONS INDEX

*NOTE: See following pages for application descriptions.*

1. DC 505A Trigger Level Output
2. Network Attenuation or Gain Measurement
3. PS 503A Voltage Regulation via Remote Sensing
4. PS 503A Output Voltage Controlled by External Resistance Programming
5. PS 503A Output Voltage Controlled by External Voltage Programming
6. Waveform Generation System
7. Integration through V to F Conversion
8. Function Generator Swept Frequency Applications
9. Power Supplies Driven by Signal Sources
10. AC Microvoltmeter

---

\* TEKTRONIX, INC.  
P. O. Box 500  
Advertising Dept., M/S 76-260  
Beaverton, Oregon 97077

### 1. DC 505A TRIGGER LEVEL OUTPUT CONNECTION TO AN ALONGSIDE DMM

Any TM 500 DMM can be used to read out the A and B trigger "level out" of the DC 505A universal counter. The benefit of this interfacing feature is improved accuracy in making width B and time interval A → B measurements.

These features are acquired by using a DMM, in conjunction with the DC 505A gate lamp, to measure the +E peak and the -E peak levels of the pulse train to be counted. The peak-to-peak measurement is then used to determine the correct setting of the level controls for the measurement of interest.

The actual connections between the DMM and DC 505A are made as illustrated below:

<u>DMM</u>			<u>DC 505A</u>
28B	←	signal	→ 22A
28A	←	ground	→ 17A

### 2. NETWORK ATTENUATION OR GAIN MEASUREMENT

The dBm or dBV measurement capability of the DM 502 can be used to measure the attenuation or gain of a network under test when driven by an SG 502 audio generator. Audio network analysis can be performed on networks such as filters and amplifiers.

Upon completion of interface connections (see below), operation consists of pressing DM 502 INT button to read network input level. Press back to EXT for network output level. The network gain or loss in dB is obtained by subtracting the input and output levels.

The actual connections between instruments to be interfaced follow:

<u>SG 502</u>	<u>NETWORK</u>	<u>DM 502</u>
28A (SIG OUT)	-	28B (HI)
27A (SIG GND)	-	28A (LO)
FRONT PANEL	INPUT (SIG)	-
BNC OUT	INPUT (GND)	-
-	OUTPUT (SIG)	FRONT PANEL (HI)
-	OUTPUT (GND)	FRONT PANEL (LO)

### 3. PS 503A VOLTAGE REGULATION VIA REMOTE SENSING

The plus or minus 20 V power supply regulation can be improved by

remote sensing at the load. For more details see PS 503A MODULE DATA section.

#### 4. PS 503A OUTPUT VOLTAGE CONTROLLED BY EXTERNAL RESISTANCE PROGRAMMING

The plus or minus 20 V power supply can be controlled via resistance programming through the rear interface. Specific details on program resistance values and interconnections may be found in the PS 503A MODULE DATA section.

#### 5. PS 503A OUTPUT VOLTAGE CONTROLLED BY EXTERNAL VOLTAGE PROGRAMMING

The plus or minus 20 V power supplies can be controlled via an external voltage source through the rear interface. One or both supplies can now be independently swept from 0 to 20 volts. The slew rate depends on the load and the output voltage  $dV/dt$ . Specific interconnection and external voltage control information may be found in the PS 503A MODULE DATA section.

#### 6. GENERATING COMPLEX WAVEFORMS WITH TM 500 INSTRUMENTS

The generation of a variety of differently-shaped signals can be produced by an RG 501 Ramp Generator, two PG 505 Pulse Generators, and an AM 501 Operational Amplifier. An alongside TM 500 oscilloscope such as the SC 501 or SC 502 can be used along with this system to provide a means of determining signal periods, durations, rise and fall times, delay times as well as peak-to-peak signal amplitudes. For complete details on this Waveform Generation System, write the TM 500 Advertising Dept. for application note #75M 1.0.

#### 7. INTEGRATION THROUGH V TO F CONVERSION

Measurement transducers are often used to produce a voltage that is proportional to the rate of flow of something like a gas, a liquid, or electrical energy. But, frequently it is more important to know the total number of units that have been measured by the transducer during some time interval like a second or a day, than it is to know the rate at any particular point in time. Three particular TM 500 instruments can be configured together to provide this voltage to frequency conversion. The transducer output is first processed by a signal conditioning AM 501 or AM 502 Operational Amplifier. The resulting output is applied to produce an analog to frequency conversion in a function generator such as an FG 501 or FG 502. The output frequency is displayed on an alongside digital counter. For more complete information on this application, write the TM 500 Advertising Dept. for application note #75M 2.0.



## 8. FUNCTION GENERATOR SWEPT FREQUENCY AND TWO-TONE APPLICATIONS

Although this application was written specifically for the FG 501, the underlying principles apply equally well to the more recent function generators such as the FG 502 and FG 503. A function generator can be made to change its output frequency as determined by the instantaneous applied voltage appearing at the VCF input BNC connector. For example, a voltage ramp applied to the VCF input will provide a linear change in output frequency. A square-wave voltage will provide two output tones, the output frequency of which is determined by the specific levels of the top and bottom portions of the square wave. For example, the two-tone output capability could be used for FSK applications where the FG 501 dial setting is the mark frequency and the positive amplitude is the space frequency. For more complete information on this application, write the TM 500 Advertising Dept. for the application note entitled "FG 501 Swept Frequency Applications."

## 9. POWER SUPPLIES DRIVEN BY SIGNAL SOURCES

Any of the analog programmable power supplies such as PS 501, PS 503, or PS 503A plug-ins can be driven by an adjacent signal or function generator to provide a low source impedance suitable for delivering higher currents into a low impedance load. Some load examples would include drive relays, lamps, small motors, loudspeakers, etc. The power supply will follow the signal sources output frequency and risetime up to its slew rate limitations. Specific information on voltage driving power supply sense inputs can be found in the MODULE DATA section under Power Supply Interface Notes.

## 10. MICROVOLTMETER

The AM 502 and DM 501 can provide ac and dc microvolt measurements. When the AM 501 is set for a gain of 1000 (dc-coupled) and its rear interface SIGNAL OUT (28A) and SIGNAL OUT GROUND (27A) are connected to the DM 501's rear HI INPUT (28B) and LO INPUT (28A), respectively, the DM 501 will provide a 2 millivolt dc or ac full scale digital display on the 2-volt ranges. This measurement application can be used in setting up low audio signal output levels from an adjacent audio signal source such as the SG 502.

# SECTION 3

## REFERENCE INFORMATION

This section contains the following topics: Interface Connections, Barrier Keys, Interfacing and Standard Mainframe, Interfacing the Option 2 Mainframe, Quick Change Interfacing, External Interfacing, and a Table of Plug-in and Mainframe Power Requirements.

### INTERFACE CONNECTIONS

The plug-in rear interconnections are made at the rear of the power mainframes module interface circuit board.\* See Figure 3-1. On this board are mounted double edge 28 pin connectors for accepting plug-in modules.

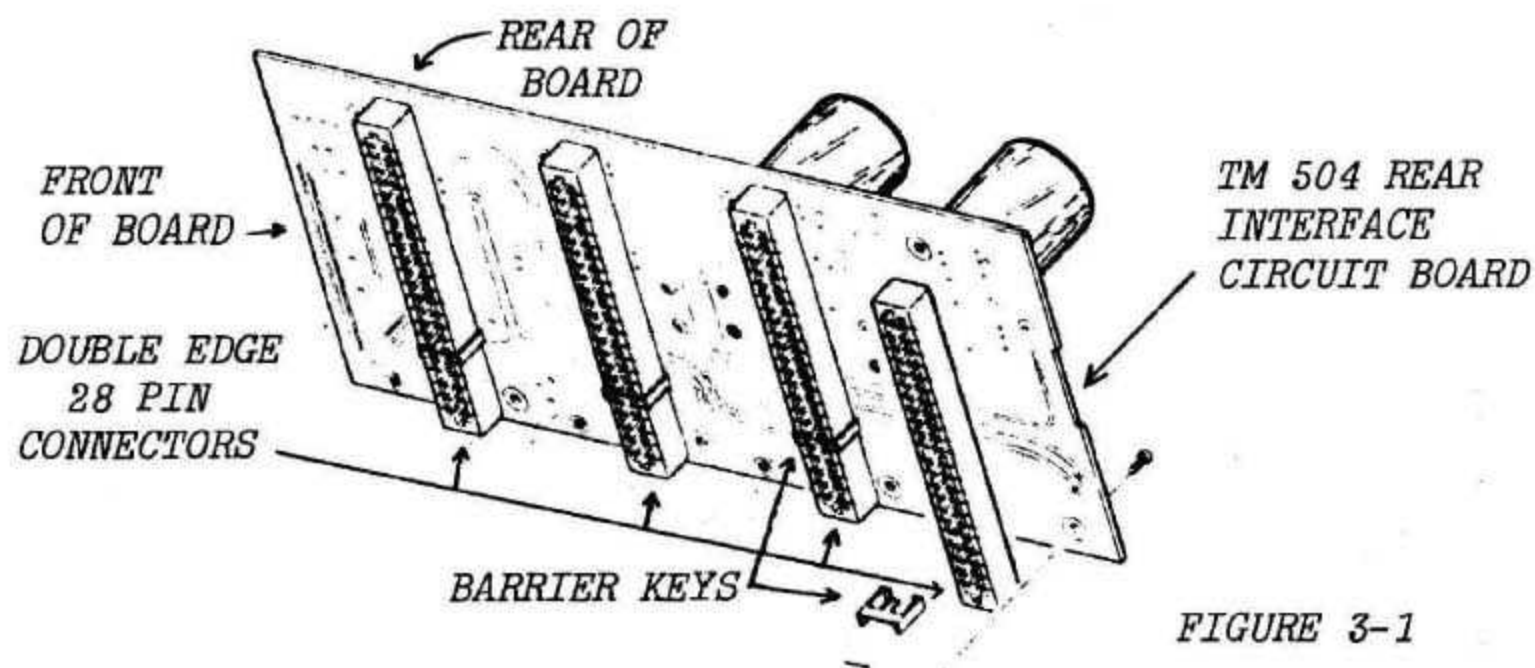

FIGURE 3-1

Each 28-pin connector is numbered starting with number 1 near the mainframe bottom and ending with number 28 near the top. However, only pin numbers starting with 14 through 28 are used for signal line data interfacing. Pins 1 through 13 are used for connections from mainframe power to the instruments. In the section on module data, a rear view of only signal line contacts 14 through 28 is given for user applications. Since each plug-in connector has a double row of contacts, the left column (as viewed from the rear of the mainframe or instrument) is designated as B and the right column as A. The actual interface connection techniques are described in the remaining portions of this section.

\*NOTE: The TM 515 rear interconnections are made at the front of the interface circuit board.



## BARRIER KEYS

A BARRIER KEY is a special plastic part\* designed to be inserted between contact pins located in the power mainframe circuit board edge connector. See Figure 3-1. Its function is to prevent the possible damage of electrically incompatible plug-in modules. This incompatibility can arise as the result of inserting plug-in modules into a mainframe prewired for a different set of TM 500 instruments. Compatible plug-in modules are classified into family categories. These categories are listed according to the following family key designations:

1. Signal Source Family Key	Pins 23 - 24
2. Measurement Family Key	Pins 21 - 22
3. DMM Family Key**	Pins 17 - 18
4. Power Supply Family Key	Pins 19 - 20
5. SC 502 Family Key	Pins 25 - 26
6. Logic Analyzer Family Key	Pins 24 - 25
7. TR 502 Key	Pins 22 - 23

Instruments belonging to the above families are listed in the table below and in the MODULE DATA section under the specific plug-in type.

FAMILY KEY LOCATIONS				
1	2	3	4	5
Signal Source Pins 23-24	Measurement Pins 21-22	DMM Pins 17-18	Power Supply Pins 19-20	SC 502 Pins 25-26
AF 501	DC 501	DM 501	PS 501	SC 502
AM 501	DC 502	DM 502	PS 501-1	
AM 502	DC 503		PS 501-2	
AM 511	DC 504		PS 503	
FG 501	DC 505		PS 503A	
FG 502	DC 505A		PS 505	
FG 503	MR 501			
FG 504	DD 501			
PG 501				
PG 502				
PG 505				
PG 506				
PG 508				
RG 501				
TG 501				
SC 501				
SG 502				
SG 503				
SW 503				

\*NOTE: If you require an extra set of 20 Barrier Keys, order TEKTRONIX part number 214-1593-02 from your local TEKTRONIX Field Office.

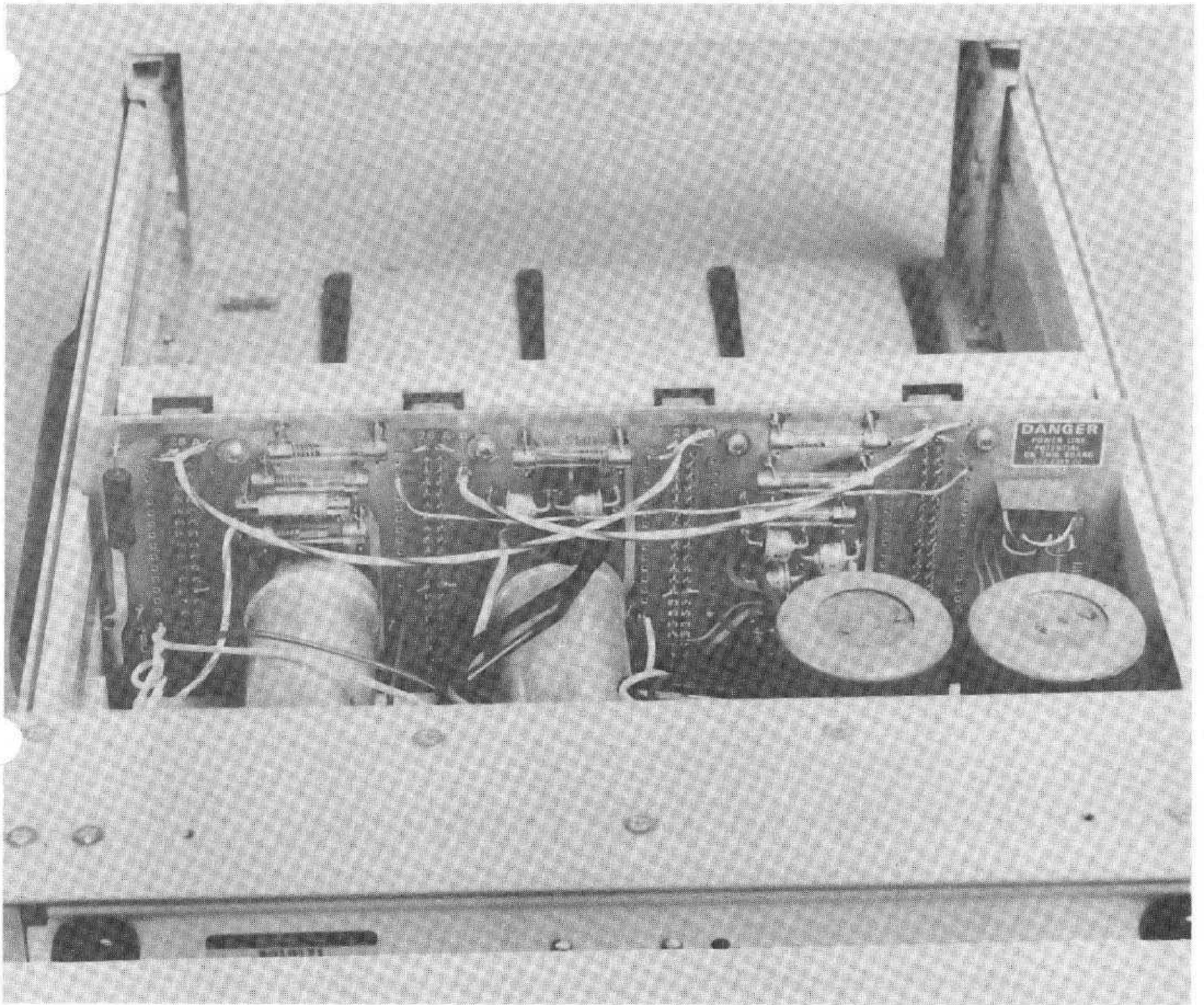

Interfacing the standard mainframe by  
soldering inter-plug-in connections.

*FIGURE 3-2*



With a barrier in place in the mainframe connector, plug-in instruments belonging to one of the above-listed families cannot be inserted into the mainframe wired for a different plug-in family. The key to this lockout feature is the actual placement of the barrier key into the double edge 28-pin connector. All plug-ins belonging to a specific family can be inserted into the module compartment containing the desired family key because of a corresponding slot cut into the mating plug-in circuit board at the family key location.

### INTERFACING TM 500

#### THE STANDARD MAINFRAME

The standard mainframe purchased without any options comes without square pin connectors. Any interfacing between plug-in compartments can be accomplished by hand soldering interconnecting wires or coaxial cables between pin locations at the rear\* of the mainframe rear interface circuit board. See Figure 3-2. A good quality insulated wire varying in sizes according to current-carrying capabilities can be used for low frequency or dc circuits. Miniature 50 $\Omega$  coaxial cables should be used in high frequency signal environments to eliminate potential crosstalk problems.

#### SPECIAL NOTES ON ORDERING COAXIAL CABLES

*NOTE #1. Small 50 $\Omega$  coaxial cable by the foot.*

*If you require a quantity of small diameter 50 $\Omega$  coaxial cable, order TEKTRONIX part number 175-1020-00 by the foot.*

*NOTE #2. Small 50 $\Omega$  coaxial cable with pre-installed special Peltola connectors on each end.*

*Some plug-in instruments do not have all inputs or outputs factory-wired to the rear and thus require special internal connections prior to rear interface use. In special cases of this nature, the required information can be found under the MODULE DATA section pertaining to the plug-in of interest. If you require small diameter 50 $\Omega$  coaxial cable with special Peltola connectors on each end, then measure and order the optimum length from the following list of cables.*

---

\*NOTE: Front in the TM 515 Traveler mainframe.

50Ω COAXIAL CABLES WITH PELTOLA CONNECTORS ON EACH END	
Length	Part Number
6 inches	175-1824-00
8 inches	175-1825-00
10 inches	175-1826-00
12 inches	175-1827-00
14 inches	175-1828-00
16 inches	175-1829-00
18 inches	175-1830-00

*IMPORTANT NOTE: If you intend to interconnect your mainframe as a dedicated system, then the standard mainframe may be purchased as a cost-saving measure. However, if you plan to make numerous rear interconnections throughout the mainframe life, you should give serious consideration to purchasing an Option 2 mainframe with pre-installed square-pin connectors. These connectors offer a way to eliminate hand soldering to circuit board runs, thereby extending your instrument life and investment.*

## THE OPTION 2 MAINFRAMES

The Option 2 mainframes can be purchased in all the standard series except for the TM 515.\* The Option 2 mainframes are supplied with a rear panel 50-pin male connector, mating cable connector, one BNC connector per plug-in compartment, square pin connectors on the rear interface circuit board, and a special wire kit consisting of standard wires and coaxial cables with mating square-pin receptacles. The actual quantity and length of wires and coaxial cables depend on the number of mainframe compartments. The square-pin connectors are intended to provide a way to make numerous interconnections throughout the mainframe life without causing circuit board damage resulting from numerous hand-soldered connections to the interface circuit board. See Figure 3-3. The remaining components offer several interface alternatives, one of which may be more desirable than another depending upon your actual application. See *Quick Change Interfacing and External Interfacing*.

---

\*NOTE: The TM 515 Traveler mainframe, Option 5, provides square pins at the interface board and a wire kit for easy internal interconnections. Unlike Option 2 on the other mainframe, however, the TM 515 has no provision for BNCs or a 50-pin connector at the rear.



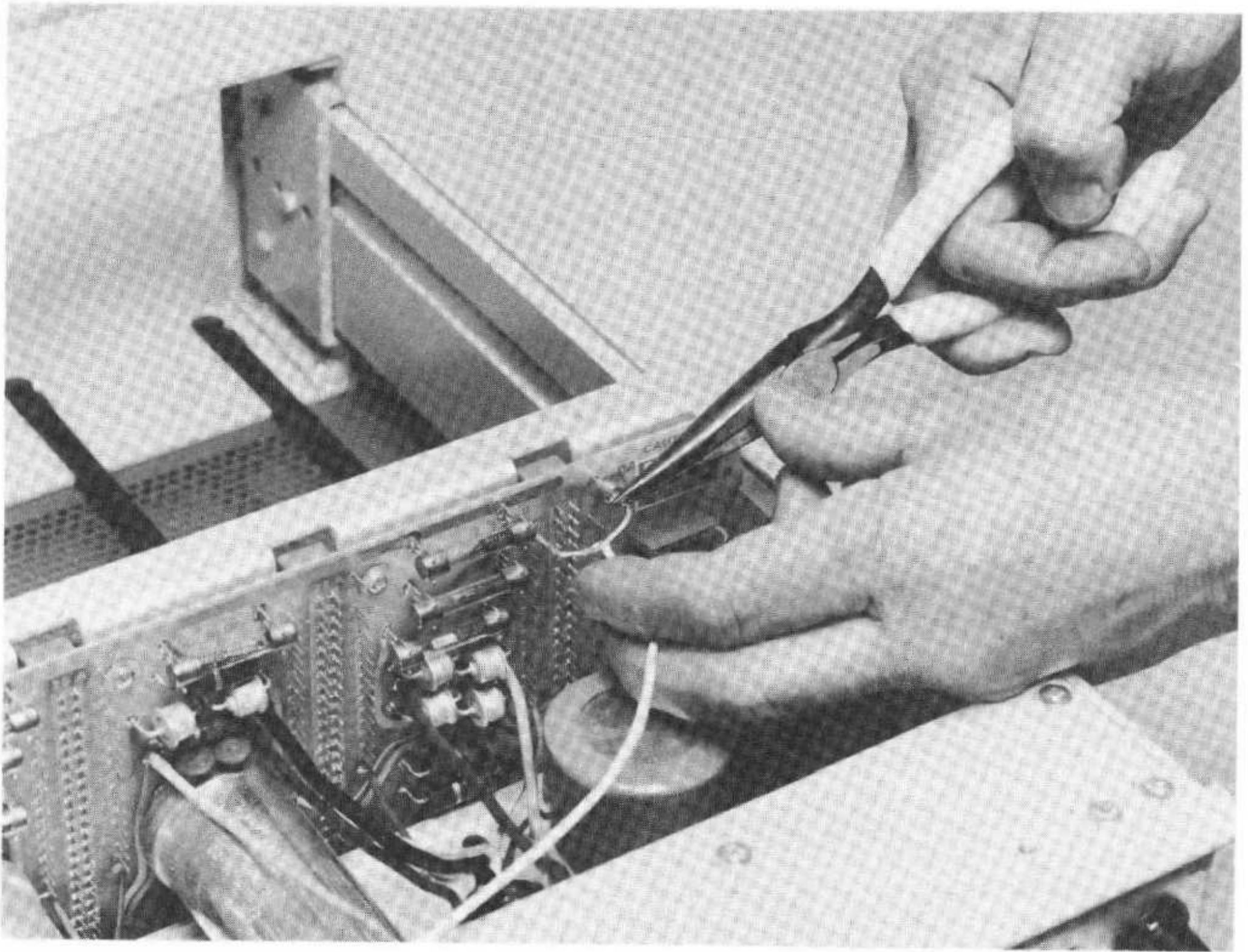

Interfacing the Option 2 mainframe  
by using square-pin connectors and  
special square-pin receptacles.

*FIGURE 3-3*

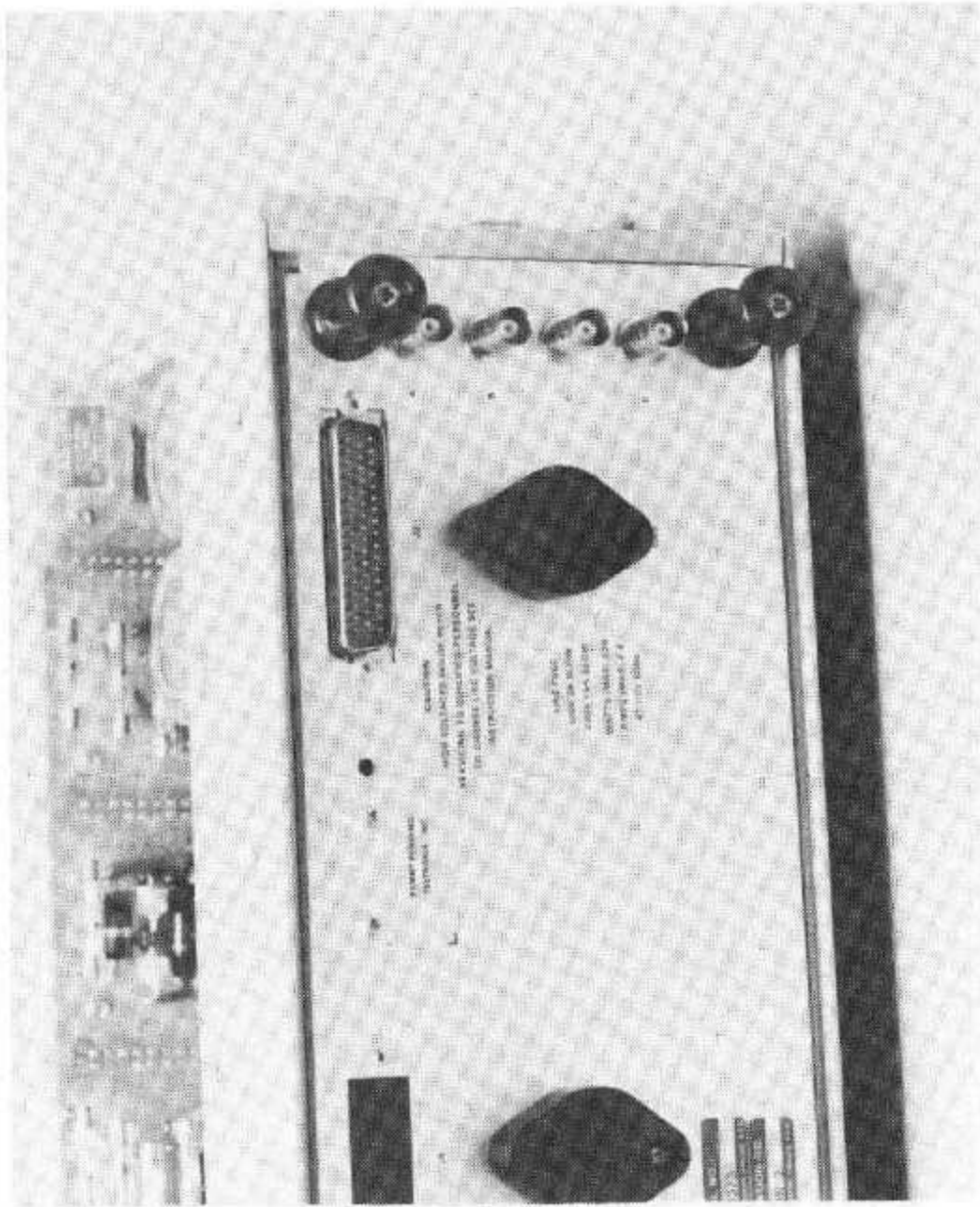

FIGURE 3-4

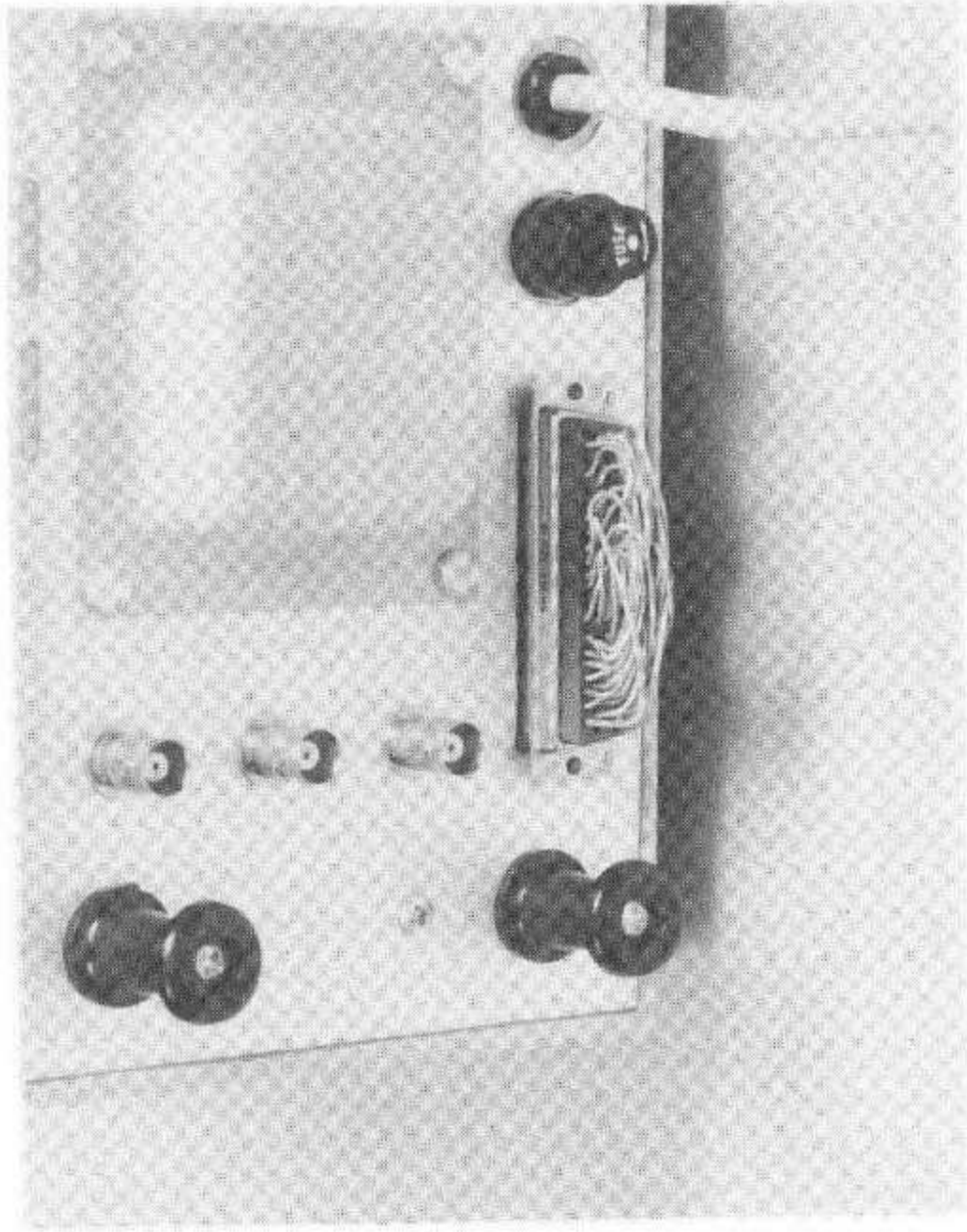

FIGURE 3-5

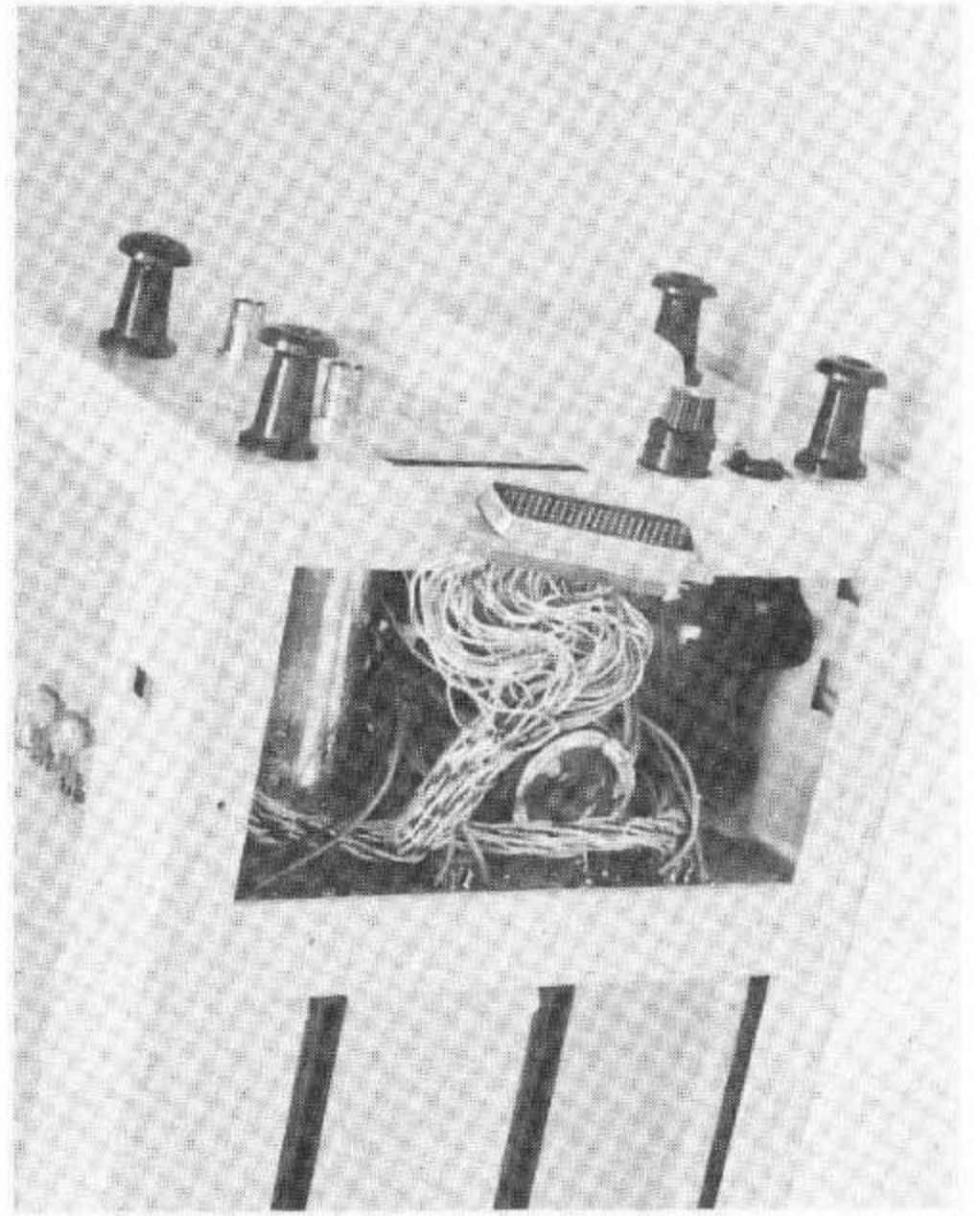

FIGURE 3-6



## QUICK CHANGE INTERFACING

The quick change interfacing feature makes use of a special set of male-female multi-pin connectors located at the rear of the mainframe. See Figure 3-4. The female multi-pin connector may be thought of as a programmer connector. The user of the quick change interfacing technique can prewire as many programmer connectors as required for each individual instrumentation set-up. After inserting the desired plug-ins into preselected mainframe compartments, the prewired programmer connector is inserted into the counterpart male multi-pin connector on the rear of the mainframe. See Figure 3-5. The prewired interconnections on the programmer connector now interconnect the desired plug-ins so that they can "talk" to one another. The quick change interfacing technique allows the user to quickly change instrumentation set-ups by (1) selecting the new plug-in configuration, and (2) choosing the correct prewired programmer connector for that specific instrumentation set-up.

The photograph of Figure 3-6 illustrates how the Option 2 mainframe can be wired to permit use of the quick change interfacing technique. These connectors are not factory-wired in order to give a system designer as much flexibility as possible. Instead, prepared jumper wires, coaxial cables, a rear 50-pin connector, and associated hardware are included along with each Option 2 mainframe. Hence, there are no pin assignments for rear panel connectors because of the wide variety of possible connections.

The external programmer connectors for quick change programming can be ordered from the list of hardware materials below.

### QUICK CHANGE EXTERNAL PROGRAMMER CONNECTORS (UNWIRED)

50-PIN FEMALE PROGRAMMER HARDWARE		
Part Number	Description	Quantity
131-1319-00	Cover, conn; molded plastic w/hardware	1 each
131-1345-00	Conn, rcpt, elec: 50 contact female	1 each

## EXTERNAL INTERFACING

The external interfacing technique makes use of the Option 2-supplied 50-pin rear male connector as a means to interface with equipment external to the TM 500 system. See Figure 3-7. Users can order additional hardware to make up a completed plug-on external connector from the following parts list.

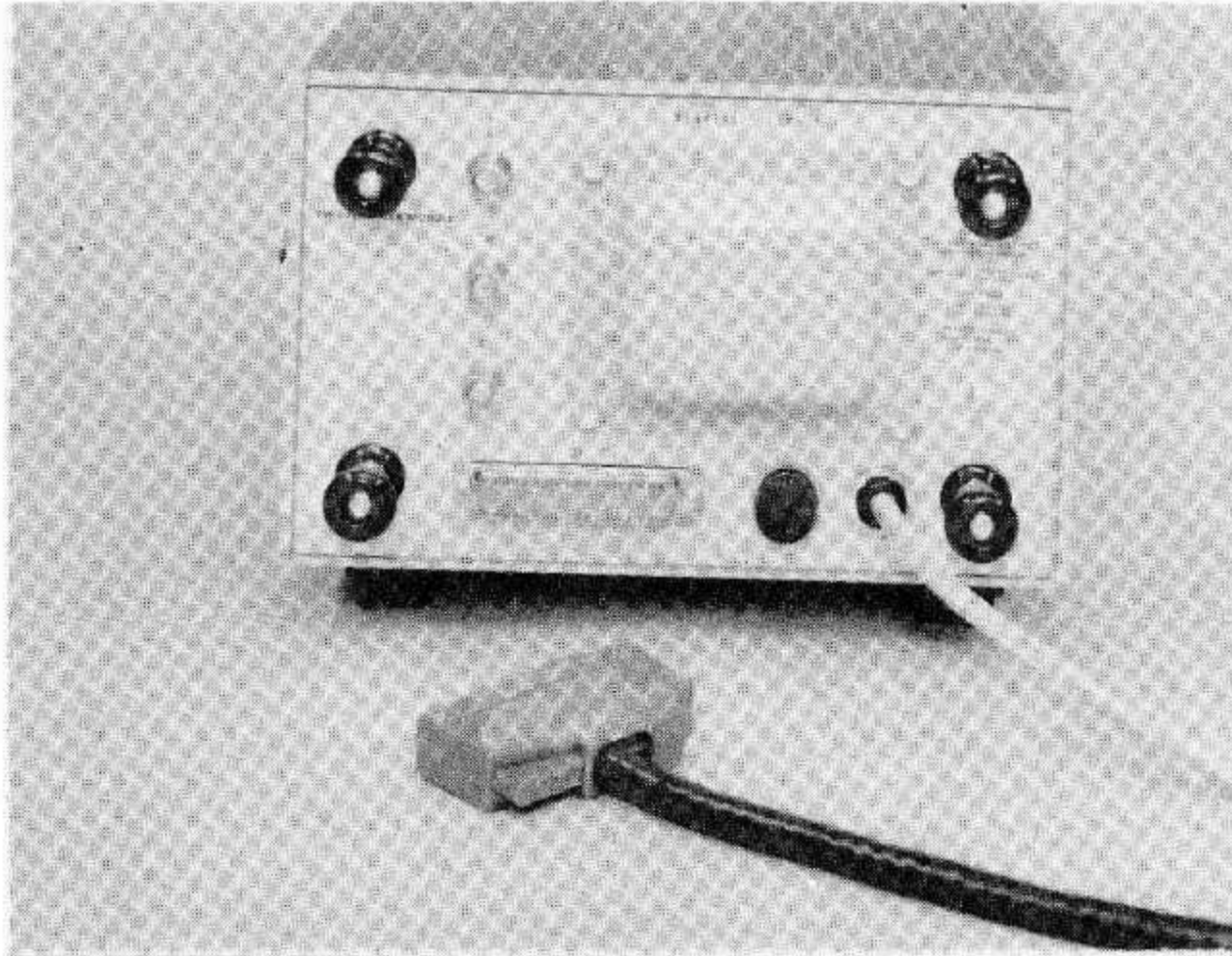

FIGURE 3-7



EXTERNAL CABLE CONNECTOR HARDWARE

50-PIN FEMALE CONNECTOR		
Part Number	Description	Quantity
131-1319-00	Cover, conn; molded plastic w/hardware	1 each
131-1345-00	Conn, rcpt, elec: 50 contact female	1 each

*NOTE: The number of wires contained within the external connector cable depends upon the specific user's requirements. The external multi-conductor cable should be obtained from a local multi-conductor cable supplier or vendor.*

**CAUTION:** In the event your mainframe is sent to a TEKTRONIX Service Center for service, please notify the service center that the mainframe has been interfaced. This will save money and expedite the return of your instrument. It is advisable to return both power module and plug-in(s) to the service center.

The following table for TM 500 plug-ins is provided as a convenient way to determine the power required for each instrument. A minimum and maximum value in WATTS is given for three line voltage values of LOW LINE (108 VAC), NORMAL LINE (120 VAC) and HIGH LINE (132 VAC). The minimum and maximum values arise as a result of different front panel control settings of individual plug-ins and varying external loads connected to power supplies and signal sources. To calculate the total power which will be drawn by a system, add the appropriate instrument requirements to the mainframe requirement at the bottom of the table.

POWER REQUIREMENTS FOR TM 500 PLUG-INS AND MAINFRAMES

Instrument	Low Line - 108 VAC		Nominal Line - 120 VAC		High Line - 132 VAC	
	Min. Watts	Max. Watts	Min. Watts	Max. Watts	Min. Watts	Max. Watts
AF 501	2.0	2.0	2.0	2.0	3.0	3.0
AM 501	6.5	9.5	7.5	11.0	9.0	13.0
AM 502	5.5	5.5	9.5	9.5	7.5	7.5
DC 501	17.5	19.0	19.0	21.5	22.5	25.0
DC 502	17.5	19.0	19.0	21.5	22.5	25.0
DC 503	16.5	19.0	18.0	21.5	20.5	25.0
DC 504	10.4	11.4	13.5	14.1	15.4	16.3
DC 505/A	28.3	29.3	31.6	32.6	34.7	35.6
DD 501	14.0	14.0	16.0	16.0	18.0	18.0
DM 501	11.5	12.5	12.5	14.0	15.0	16.0
DM 502	8.2	8.2	12.8	12.8	18.2	18.2
FG 501	14.5	17.5	16.5	19.0	19.0	22.5
FG 502	17.5	17.5	20.0	20.0	23.0	23.0
FG 503	10.9	12.0	12.2	13.5	13.5	14.8
FG 504	37.0	43.0	42.0	48.0	47.0	52.0
LA 501	40.0	44.0	40.0	44.0	40.0	44.0
MR 501	11.0	11.0	12.0	12.0	14.0	14.0
PG 501	13.5	23.5	15.0	26.0	17.5	29.0
PG 502	13.0	17.5	14.5	20.0	17.0	22.5
PG 505	10.5	13.5	12.0	15.5	14.0	18.0
PG 506	5.3	16.3	6.3	18.6	8.1	21.8
PG 508	35.0	40.0	40.0	45.0	45.0	50.0
PS 501	4.5	40.5	6.0	42.5	6.5	46.5
PS 502	6.5	56.5	8.0	66.0	9.5	72.5
PS 503	7.5	66.5	9.0	71.0	12.0	77.5
PS 503A	4.2	64.5	5.6	72.2	8.1	80.1
PS 505	1.2	41.3	1.8	45.9	2.3	50.0
RG 501	6.0	6.0	7.0	7.0	8.5	8.5
SC 501	14.5	14.5	16.5	16.5	18.5	18.5
SC 502	23.3	23.3	24.9	24.9	25.2	25.2
SG 502	4.5	4.5	5.5	5.5	6.0	6.0
SG 503	18.5	18.5	21.0	21.0	24.0	24.0
SG 504	8.0	11.0	9.0	12.0	9.0	12.0
SW 503	11.0	11.0	11.0	11.0	12.0	12.0
TG 501	25.5	26.0	29.0	29.5	33.0	33.5
TM 501	2.5	2.5	3.0	3.0	3.5	3.5
TM 503	6.0	6.0	7.0	7.0	11.0	11.0
TM 504	11.0	11.0	18.0	18.0	28.0	28.0
TM 506	20.0	20.0	24.0	24.0	31.0	31.0
RTM 506	27.0	27.0	31.0	31.0	38.0	38.0
TM 515	11.0	11.0	11.0	11.0	12.0	12.0
TR 502	10.0	10.0	10.0	10.0	11.0	11.0

TM 500 PLUG-IN WEIGHTS, NET, APPROX.

(LESS EXTERNAL CABLES/ACCESSORIES)

AF 501	1.8 lb.	PS 501	1.6 lb.
		PS 503	1.9
AM 501	1.8	PS 505	1.1
AM 502	1.8		
		RG 501	1.3
DC 501	1.8		
DC 502	1.8	SC 501	2.1
DC 503	2.1	SC 502	5.6
DC 504	1.4		
DC 505/A	2.3	SG 502	2.0
		SG 503	2.0
DD 501	1.5	SG 504	2.6
DM 501	1.8	SW 503	3.3
DM 502	2.0		
		TG 501	2.0
FG 501	1.8		
FG 502	1.8	TR 501	7.1
FG 503	1.4	TR 502	7.3
FG 504	3.9		
		WR 501*	6.4*
LA 501	3.8		
		TM 501	5.4
MR 501	2.1	TM 503	9.5
		TM 504	20.5
PG 501	1.5	TM 506	29.0
PG 502	1.8	RTM 506	31.5
PG 506	2.3	TM 515	22.5
PG 508	3.6		

\* Includes LA 501 & connection cables.



## SECTION 4

# TM 500 DOUBLE-WIDE AND SINGLE-WIDE BLANK PLUG-IN KITS

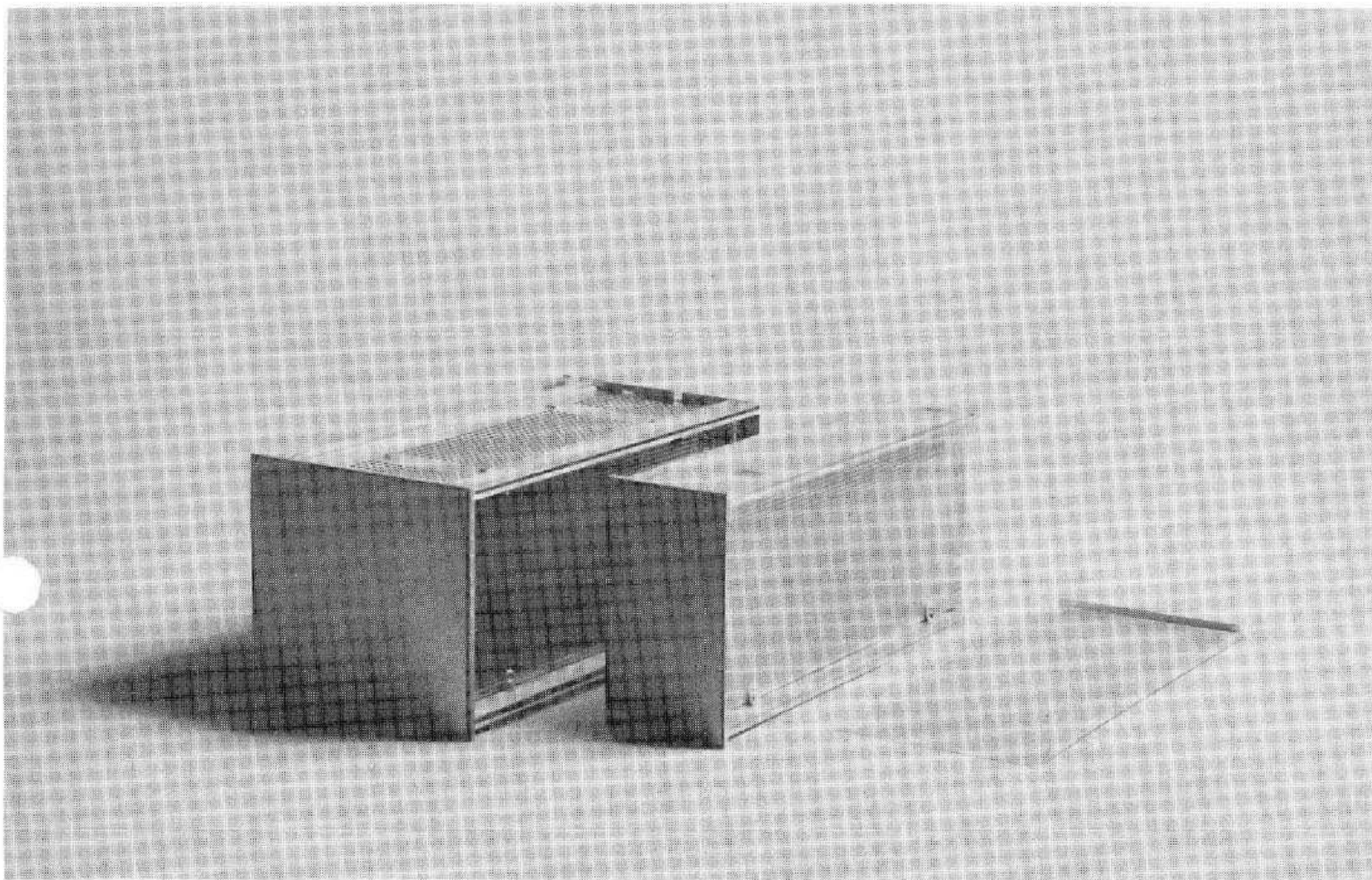

Single-wide blank plug-in kit  
Double-wide blank plug-in kit

Order 040-0652-01  
Order 040-0754-00

Both blank plug-in kits illustrated above are intended for users who require a way to design their own TM 500 plug-in in order to complete a TM 500 working instrumentation system. All basic plug-in parts are furnished as shown above along with a set of instructions detailing maximum available power to each plug-in as a load. An additional power supply design booklet "A3186" can be ordered separately from the TM 500 Advertising Dept.

# **SECTION 5**

## **SIGNAL PROCESSORS**

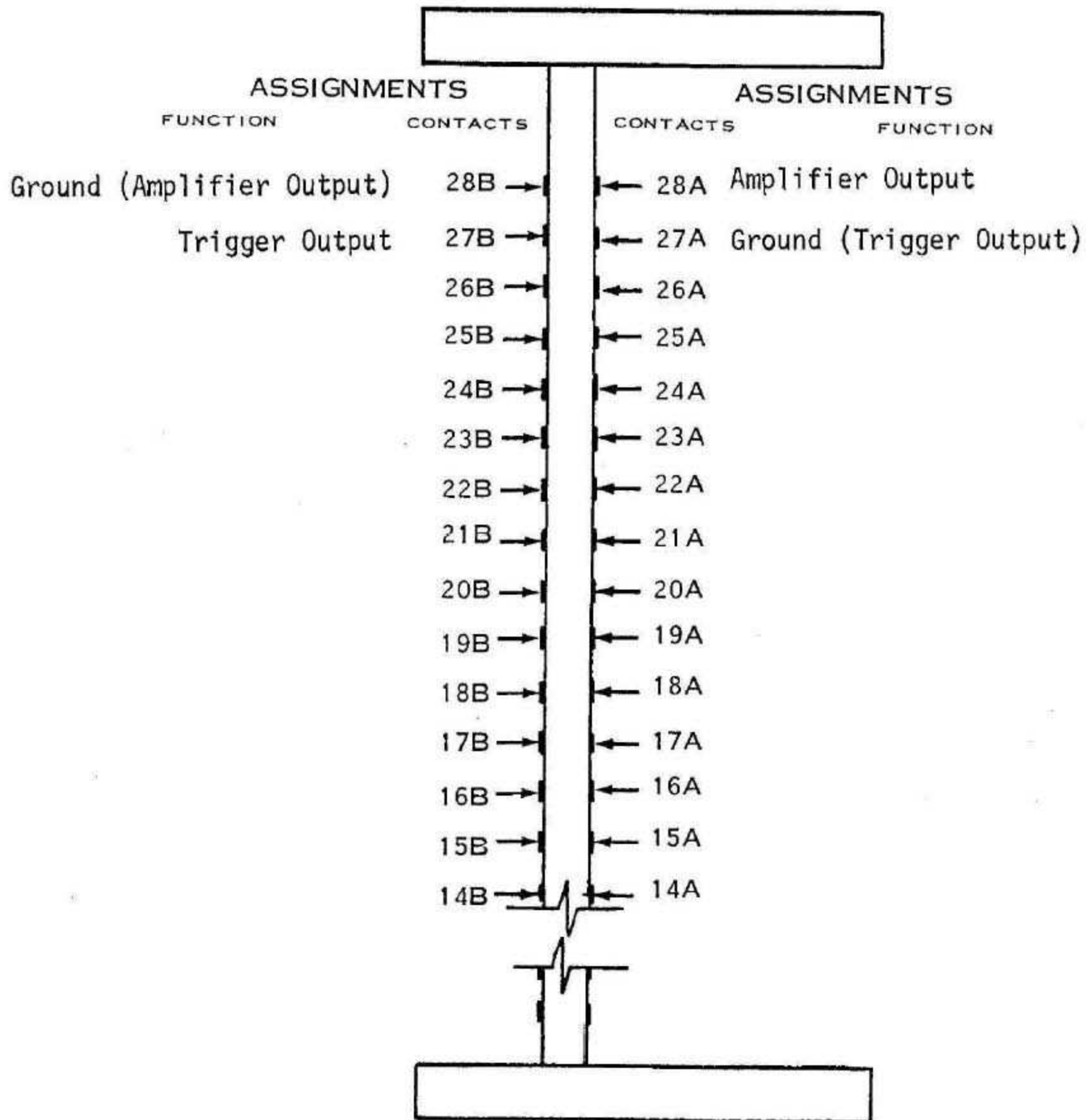

## Plug-In or Power Module Rear View

**CAUTION**

*When a Power Module compartment has been selected for the AF 501 and wired for a specialized interface system, a plastic barrier (Tektronix Part Number 214-1593-02) should be installed in a key slot between contacts 23 and 24 on the Power Module.*

*Do not insert any TM 500 Series plug-in in a live Power Module and do not use excessive force when inserting the plug-in.*

## INTERFACE NOTES

### Amplifier Output

Contact 28A is placed in parallel with the front-panel OUTPUT connector when switch S210 (internal Output) is set to Int position. The specifications for contact 28A are the same as those stated for the front-panel connector.

### Trigger Output

Contact 27B is placed in parallel with the front-panel TRIG OUT connector when switch S310 (internal Trig Out) is set to Int position. The specifications for contact 27B are the same as those stated for the front-panel connector.

### Ground (Trigger Output and Amplifier Output)

Contacts 27A and 28B are both switched to chassis ground. Contact 27A is switched to ground at the same time the Trigger Output is switched to the rear interface by S310, while contact 28B is switched to ground at the same time the Amplifier Output is switched to the rear interface by S210.

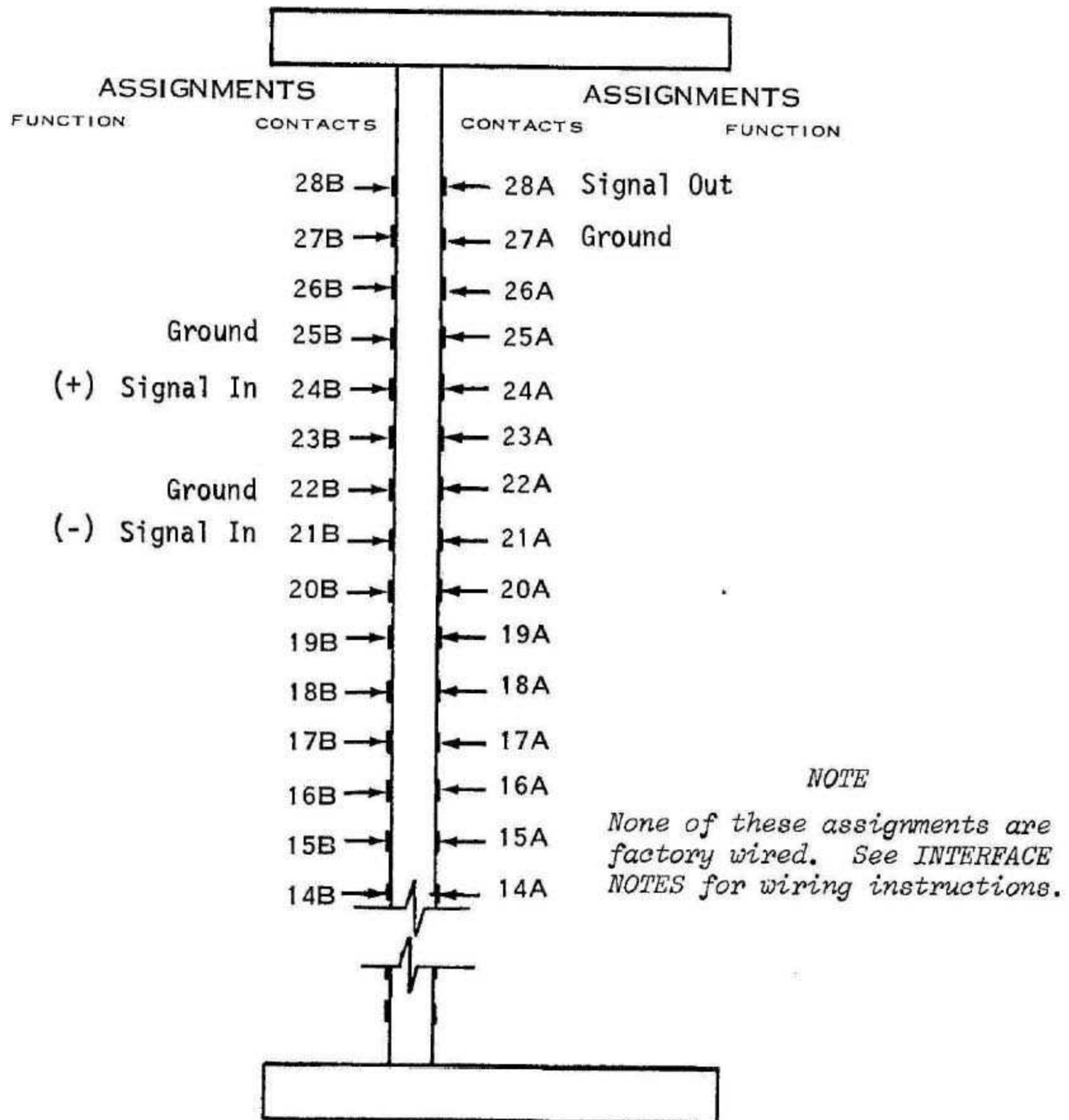

## Plug-In or Power Module Rear View

**CAUTION**

When a Power Module compartment has been selected for the AM 501 and wired for a specialized interface system, a plastic barrier (Tektronix Part Number 214-1593-02) should be installed in a key slot between contacts 23 and 24 on the Power Module.

Do not insert any TM 500 Series plug-in in a live Power Module and do not use excessive force when inserting the plug-in.

## INTERFACE NOTES

### Introduction

None of the rear pin connectors (except power supply connections) are factory wired. Instead, pins 21A through 28A and 21B through 28B have their own solder pads (holes) to allow the user to hard wire his own input and output connections to the rear interface. The pin assignments listed on page 1 are suggested in order to ensure compatibility with other TM 500 Series instruments.

### Signal Out (Contact 28A) and Ground (Contact 27A)

Pin 28A at the rear connector should be thought of as an output terminal for signals obtained from a specific point in a simple or complex operational amplifier feedback circuit. A specific output terminal is not always the same point that is connected to one of the front panel output connectors. To connect pin 28A to the specific output terminal, solder #22 or #26 wire (of the proper length) from the solder pad for pin 28A to the desired point in the operational amplifier circuit. This point may be located on the circuit board or at one of the front panel output connectors, depending on your circuit requirements. If necessary, you can disconnect an undesirable front panel output connection.

Using #22 or #26 wire, solder the proper length from the solder pad for pin 27A to the large foil area marked GND on the "A" side of the Main Circuit Board. In some types of operational amplifier circuitry, it may not be desirable to connect pin 27A to GND (chassis); in those cases pin 27A would be a "floating" connection and the design of external circuitry connected to the rear interface must take this fact under consideration.

### Making Signal Input and Ground Connections

Use #22 or #26 wire to hard wire the - Signal In (inverting input) from the solder pad (hole) for 21B to the input of your circuit. Hard wire pin 22B to the large foil area labeled GND on the "A" side of the Main Circuit Board. Perform the same operations for the + Signal In (non-inverting input) from pin 24B to the input of your circuit and hard wire the GND connections for pin 25B in the same manner as stated for pin 22B. High frequency signals may require the use of miniature coaxial cable instead of standard gauge wire.

#### NOTE

*If more than a foot or two of coaxial cable is connected to the rear interface output contact (pin 28A), an isolation resistor equal in value to the coaxial cable impedance should be inserted in series with the center conductor of cable. The purpose of the series resistor is to reduce ringing effects due to loading factors.*

## Plug-In or Power Module Rear View

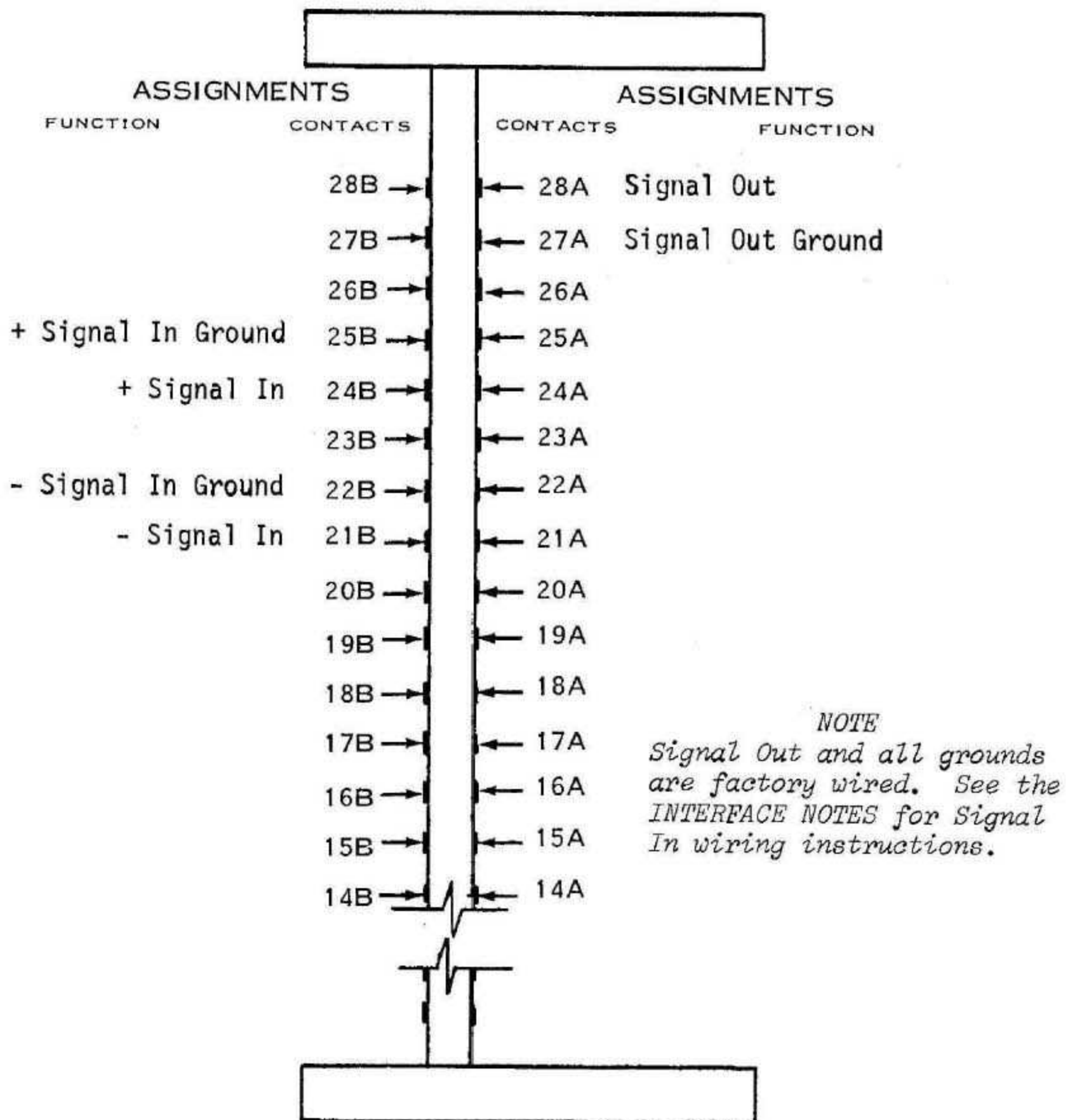
**CAUTION**

When a Power Module compartment has been selected for the AM 502 wired for a specialized interface system, a plastic barrier (Tektronix Part Number 214-1593-02) should be installed in a key slot between contacts 23 and 24 on the Power Module.

Do not insert any TM 500 Series plug-in in a live Power Module and do not use excessive force when inserting the plug-in.

## INTERFACE NOTES

### Signal Out (Contact 28A) and Signal Out Ground (Contact 27A)

Pins 28A and 27A are factory wired to rear interface contacts. Pin 27A is chassis ground. It is not necessary to disconnect the Signal Out from the front panel bnc connector to use the output signal on pin 28A.

### Signal Input Connections (Contacts 24B, 21B, 25B, and 22B)

These input connections must be user wired. Use the center conductor of a miniature 50  $\Omega$  coaxial cable (about 11 inches long) to hard wire (solder) the + Signal In (pin 24B) and the - Signal In (pin 21B) from the associated solder pads at the rear connector pins to the appropriate + and - front panel bnc connectors. Solder the associated coaxial cable shields (braids) to the associated solder pads for the chassis ground connections (pin 25B for + Signal In and pin 22B for - Signal In).

#### NOTE

*The addition of coaxial cable connections to the front panel bnc connector increases the input capacitance.*



## Plug-In or Power Module Rear View

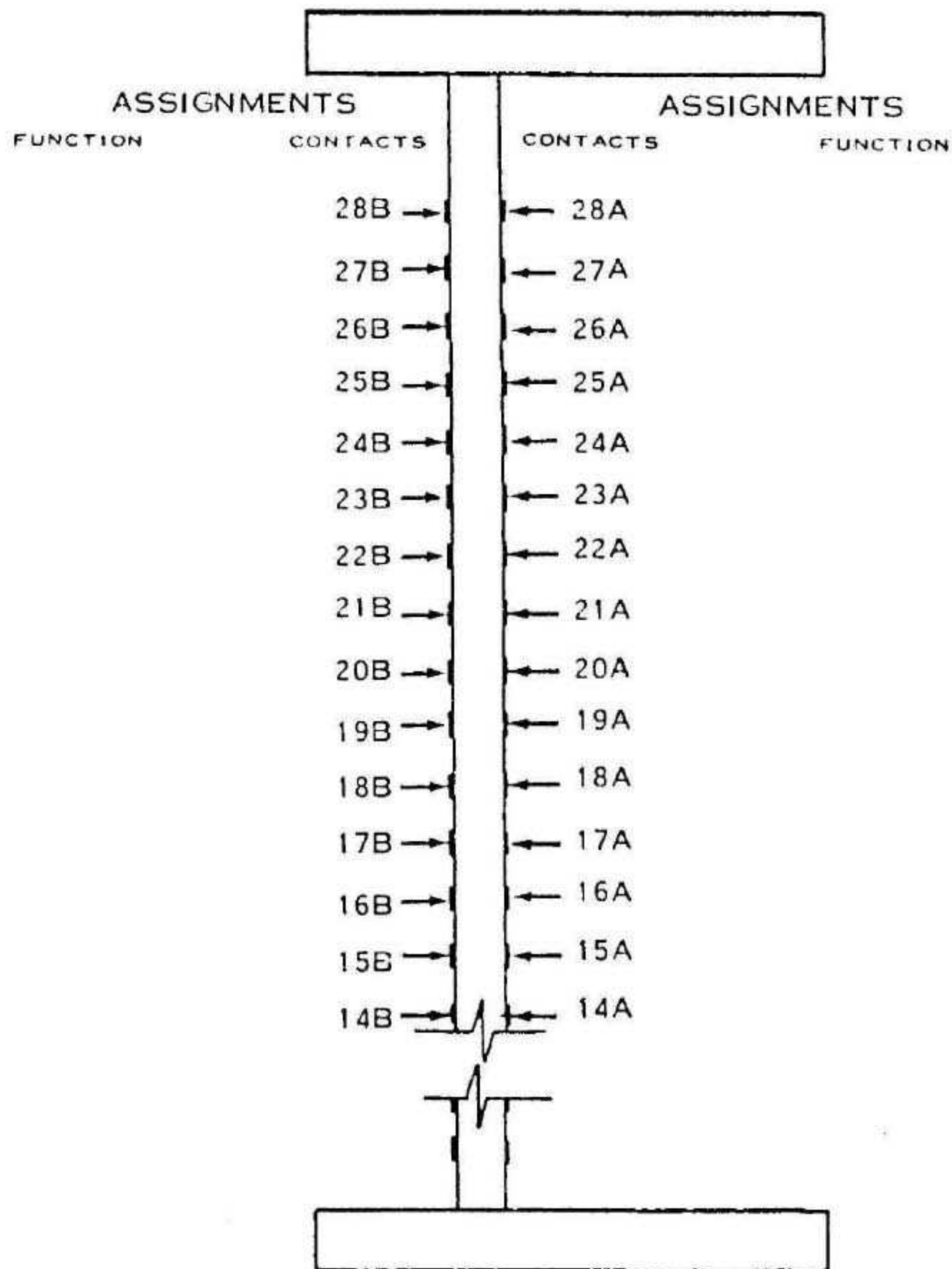

Each Rear Interface Connection shown has its own through-hole-plated connection pad.

**CAUTION**

*When a Power Module compartment has been selected for the AM 511 and wired for a specialized interface system, a plastic barrier (Tektronix Part Number 214-1593-02) should be installed in a key slot between contacts 23 and 24 on the Power Module.*

*Do not insert any TM 500 Series plug-in in a live Power Module and do not use excessive force when inserting the plug-in.*

# **SECTION 6**

## **DIGITAL COUNTERS**



## GENERAL COUNTER INFORMATION

### TTL Voltage Levels

The words "HI" and "LO" refer to TTL voltage levels present on the rear contacts under specific conditions. TTL specifications are as follows: A TTL LO output exists from 0.0 V to 0.4 V. A TTL HI output exists from +2.4 V to +5.0 V. Rear interface inputs will accept TTL LO voltages between 0.0 V and +0.8 V. TTL HI inputs must be between +2.0 V and + 5.0 V. Where TTL currents are given, the quantity is a maximum value.

### Time-Ladder Diagram

All of the counters use time-slot pulses derived from a Scan Clock signal to select a particular decimal digit that is displayed on a front-panel LED display. The following time-ladder diagram illustrates the basic time relationships between waveforms discussed under the INTERFACE NOTES for each Counter. No one Counter has all of the waveforms available at the rear interface. The waveforms are to be used only as a guide when interpreting the individual data discussed for each Counter.

#### NOTE

*Thorough understanding of the schematic diagrams and the exact internal connections for input/output lines to the rear contacts (found in individual instruction manuals) will be an aid in designing your specialized TM 500 interface system.*



MSD	1	.0	4	7	3	LSD
0	1	.0	4	7	3	8

TYPICAL  
FRONT-PANEL  
DISPLAY

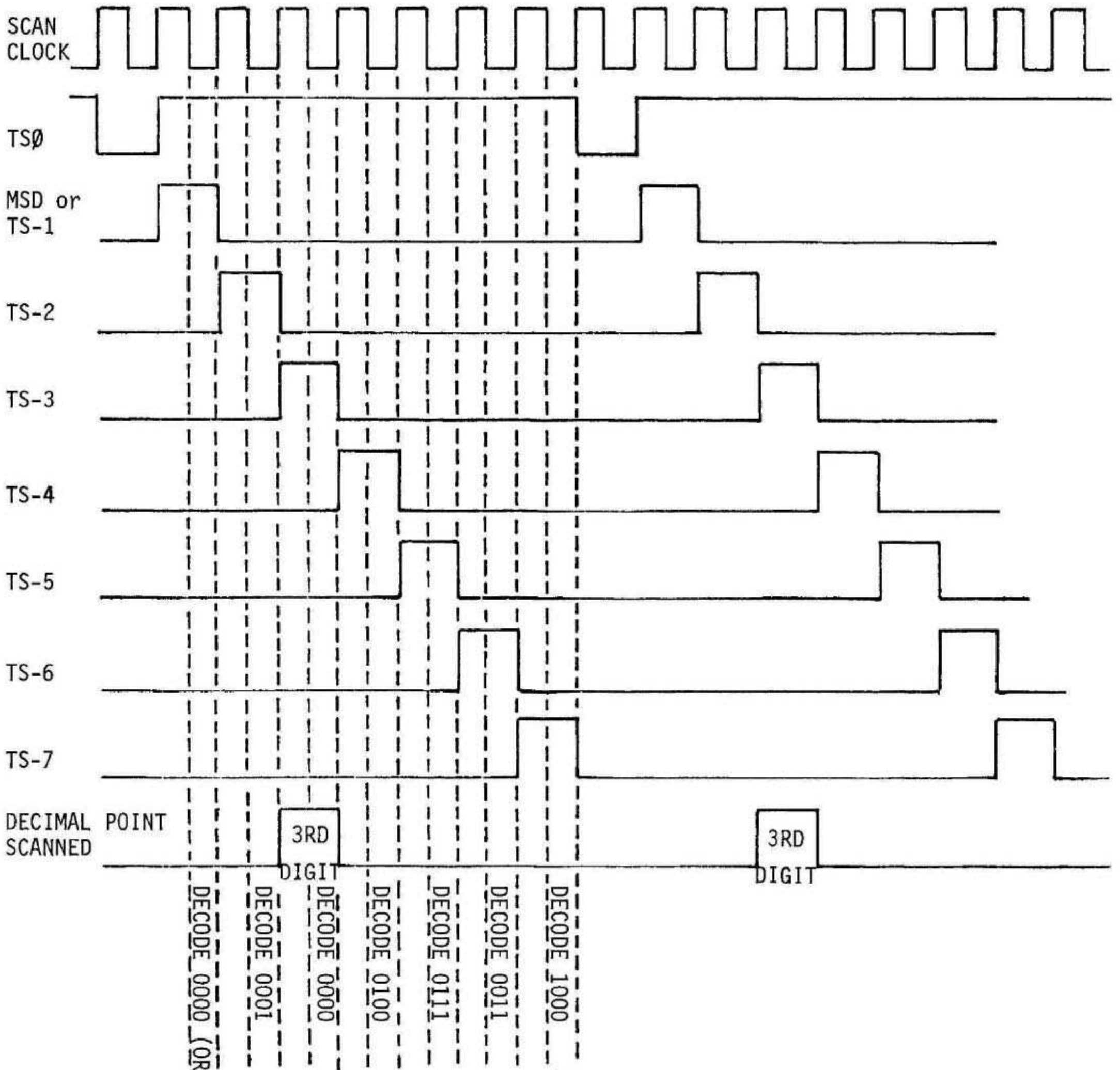

GENERALIZED TIME-LADDER DIAGRAM

Refer to INTERFACE NOTES for each individual Counter

## Plug-In or Power Module Rear View

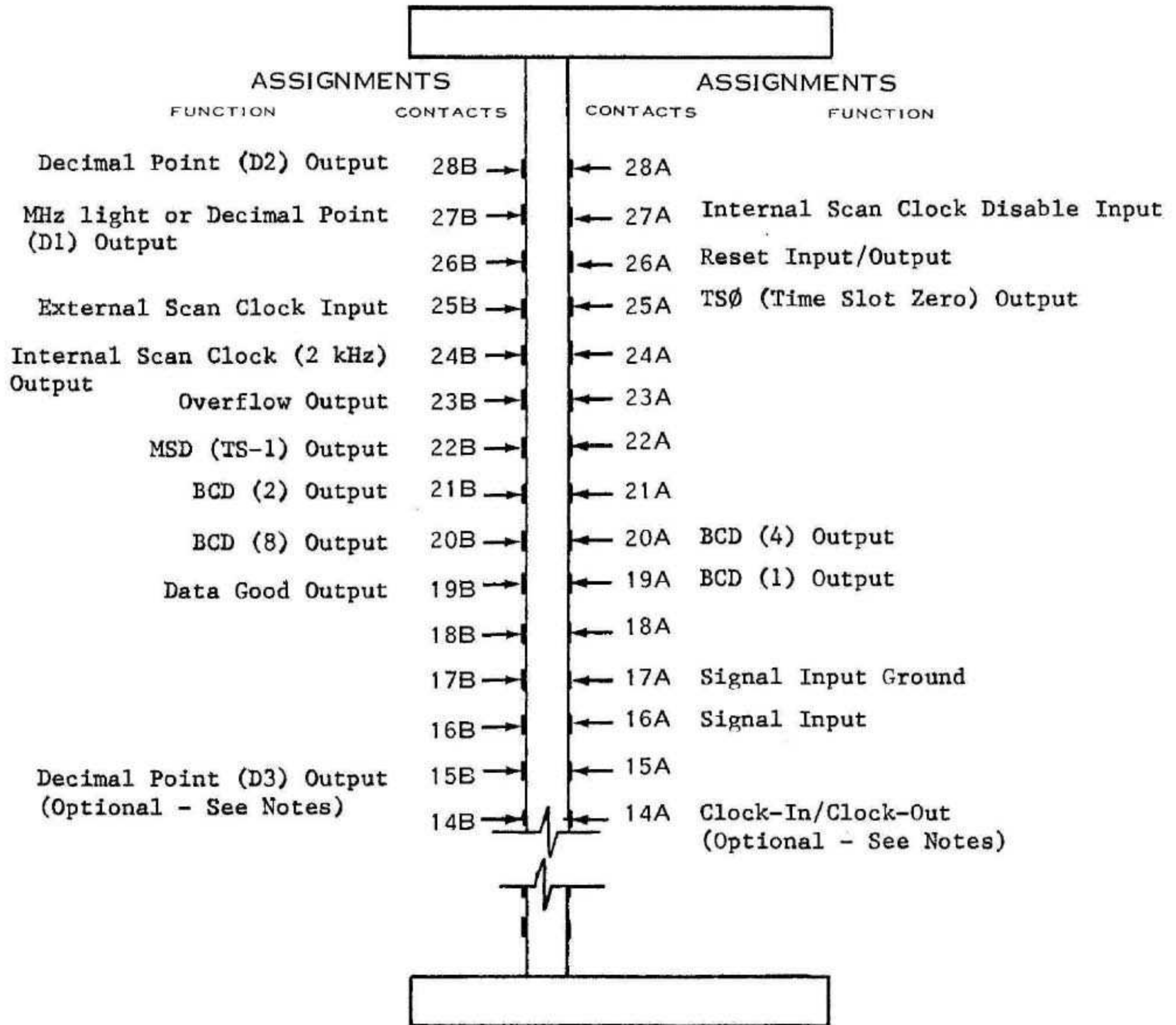

### CAUTION

When a Power Module compartment has been selected for the DC 501 and wired for a specialized interface system, a plastic barrier (Tektronix Part Number 214-1593-02), should be installed in a key slot between contacts 21 and 22 on the Power Module.

Do not insert any TM 500 Series plug-in in a live Power Module and do not use excessive force when inserting the plug-in.

## INTERFACE NOTES

### BCD Outputs (8, 4, 2, 1 Code)

Contacts 20B, 20A, 21B and 19A provide BCD data directly to the Power Module interface. The count (front-panel display) is transmitted in a serial-by-decimal digit method, with the decimal digit sequence being from left to right (MSD to LSD as observed on the front-panel display). The binary levels for each decimal digit use positive-true logic (HI = 1, LO = 0). Each output data line is capable of driving 6 TTL loads (10 mA).

### Decimal Point/Front-Panel Status Outputs

TTL logic levels are transmitted directly to contacts 27B and 28B. The data on contacts 27B and 28B is related to the position of the MEASUREMENT INTERVAL switch and front-panel decimal point location. Decimal points are numbered from left to right on the front-panel display. (See Table below.) All LO levels are caused by a switch contact closure to chassis ground, except for an Option 2 instrument where AUTO gate operation can cause the LO levels to be above chassis ground by about 0.4 volt.

CONTACT		DISPLAY		MEASUREMENT INTERVAL
27B	28B	LIGHT ON	DECIMAL POINT	
LO	LO	MHz	.0000 (D2)	.01 Sec
LO	HI	MHz	.00000 (D1)	.1 Sec
HI	HI	kHz	.000 (D3)	1 Sec
HI	LO	kHz	.0000 (D2)	10 Sec
HI	HI	GATE	000 (None)	MANUAL (Start)

*NOTE*

*If a direct active-low level output is desired for D3 (.000), it is suggested that a #22 or #26 AWG stranded wire be connected from the switch end of R284 to an unassigned rear contact that is compatible with your external equipment. Rear contact 15B is suggested.*



## Data Good Output (Contact 19B)

A positive-true Data Good pulse is transmitted directly to rear contact 19B at each updating of the DC 501 storage register. For an instrument with a 1 MHz clock, the pulse duration varies between 0.5 and 1.5 microseconds; a 5 MHz clock (Option 1) produces a pulse duration that varies between 0.2 and 1.2 microseconds. The Data Good output (19B) goes HI immediately after the internal gate time selected by the MEASUREMENT INTERVAL switch position or AUTO gate selection period (Option 2). The storage register is updated on the positive-going edge of the Data Good pulse. Rear contact 19B also goes HI and remains HI as long as the MEASUREMENT INTERVAL switch is in the MANUAL (totalize) position. This output will drive at least 6 TTL loads.

## Reset Input/Output (Contact 26A)

This contact is directly wired to the front panel RESET pushbutton and can be used as either a Reset Input or Reset Output function. Contact 26A is normally at a HI level and goes LO when the RESET button is pushed (for any positions of the MEASUREMENT INTERVAL switch), or between switch detent positions (when changing the MEASUREMENT INTERVAL switch positions). Rear contact 26A does not go LO when the DC 501 clears its own internal circuitry for another count.

To use 26A as a counter Reset Input function, it can be set to a LO by an external switch contact closure to ground or driven LO by an open-collector logic gate capable of sinking 9 TTL current loads (15 mA).

## Scan Clock Output, Input, and Disable (Contacts 24B, 25B, and 27A)

These three functions are all wired directly to rear contacts. A 2 kHz (square wave) Internal Scan Clock signal (TTL) is applied to rear contact 24B, providing a continuous output to the rear interface as long as rear contact 27A (Internal Scan Clock Disable) is held HI. The decimal digits are scanned from MSD to LSD, with the rising edge of each Scan Clock period selecting the decimal digit to be displayed. The binary levels for a selected digit remain on the BCD output lines for one complete Scan Clock period (500 microseconds for Internal Scan Clock). All of the time-slot pulses have a duration equal to a Scan Clock period. Using the Internal Scan Clock signal it takes about 4 milliseconds for a complete display scanning cycle. The ideal time to read (decode) the BCD data is during the negative half of the Scan Clock period. This requires that an external BCD decoder be driven by the falling edges of the Scan Clock signal.

Setting rear contact 27A to a TTL low disables the Internal Scan Clock and allows the application of an External Scan Clock signal to rear contact 25B. The External Scan Clock should be a TTL signal, with a maximum frequency of 1 MHz and a fall time of less than 100 nanoseconds (frequency may be less than 2 kHz, if desired). Consequently, the time of a complete display scan and time-slot pulse duration will change accordingly.



One advantage of the External Scan Clock and Internal Scan Clock Disable inputs is to allow the user to design a BCD data capture system that extracts the data at a faster or slower rate than 2 kHz. It is not intended that a high-frequency External Scan Clock be applied continuously to rear contact 25B, although it could be done. A continuous 1 MHz External Scan Clock would allow BCD data capture, but could also cause false frontpanel displays. Refer to the time-ladder diagram for an example of using the External Scan Clock and Internal Scan Clock disable pulse.

### Time-Slot Zero (TS $\emptyset$ ) and MSD (TS-1). (Contacts 25A and 22B)

TS $\emptyset$  on rear contact 25A is a TTL negative-going pulse that has a duration equal to a Scan Clock period and occurs once per complete display scanning cycle. It is a pulse that predicts that the next BCD output data on contact 20B, 20A, 21B and 19A will be equivalent to the MSD during TS-1. This pulse may be used as a synchronizing pulse for external equipment, used as a latch pulse, or to clear/reset external digital circuitry.

The MSD (TS-1) output on rear contact 22B is a TTL positive-going pulse that also has a duration equal to a Scan Clock period and occurs once per complete display scanning cycle. Some users may prefer to use the MSD (left-side digit) pulse for synchronizing external equipment, rather than using the TS $\emptyset$  pulse. TS $\emptyset$  and TS-1 are the only time-slot pulses directly wired to rear contact.

### Overflow Indication (Contact 23B)

Rear contact 23B is normally at a LO level. This contact goes HI under two conditions; (1) when the DC 501 is operated in the MANUAL (Totalize) mode and the storage register is full of nines (9999999 display), contact 23B goes HI on the next input count; (2) when making high-resolution frequency measurements by increasing the MEASUREMENT INTERVAL by a factor of 10 or greater (deliberately overflowing the display). Contact 23B is HI and time that the front-panel OVERFLOW light is on.

### Signal Input (Contact 16A and 17A)

Rear contact 16A is directly wired to the front-panel EXT - INT switch. When signals to be counted or measured are applied to contact 16A, the front-panel switch must be in the INT position. Contact 16A is terminated into a 50 ohm load (R101) and miniature 50 ohm RF cable should be used to connect signals to this contact on the Option 2 Power Module interface. Connect the coaxial-cable shield to rear contact 17A for a Signal Input Ground. Input specifications apply when signals are applied to contact 16A. Lifting the ground end of R101 converts the input resistance to 1 M $\Omega$ .

Clock-In/Clock-Out (Optional - Contact 14A)

Rear contact 14A can be used for a higher quality in-house Clock Input, or as a 1 MHz clock output, as desired. Connect a miniature 50 ohm RF cable between pin 14 of U209 and rear contact 14A. Pin 14 of U209 operates at TTL levels. Ground both ends of the coaxial-cable shield; one end to rear contact 17A and the other end to pin 7 of U209, U200, or U201. When rear contact 14A is used as a Clock Input for an unmodified digital counter, remove U200 from the circuit board; for an Option 1 instrument, remove U201.

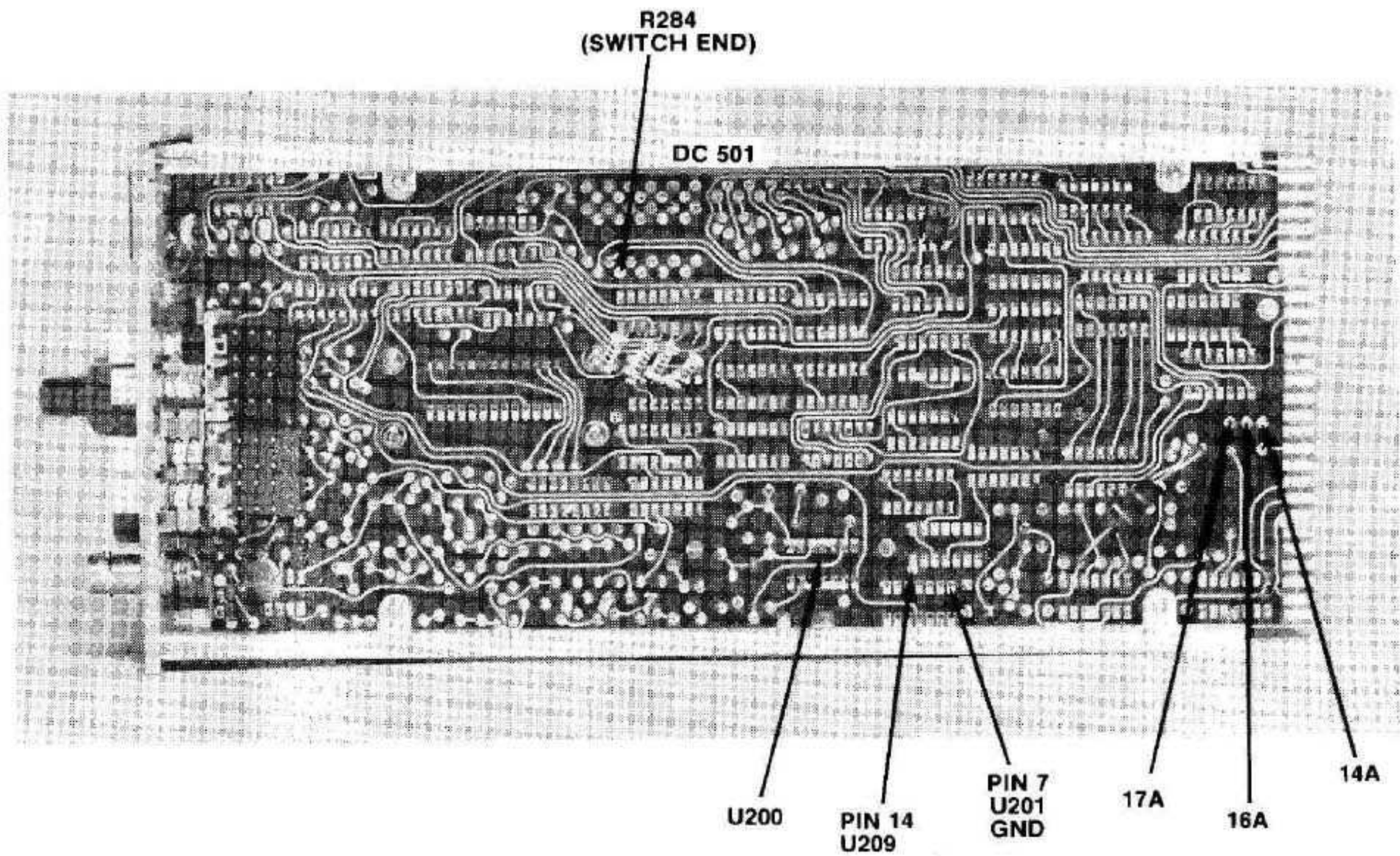





## Plug-In or Power Module Rear View

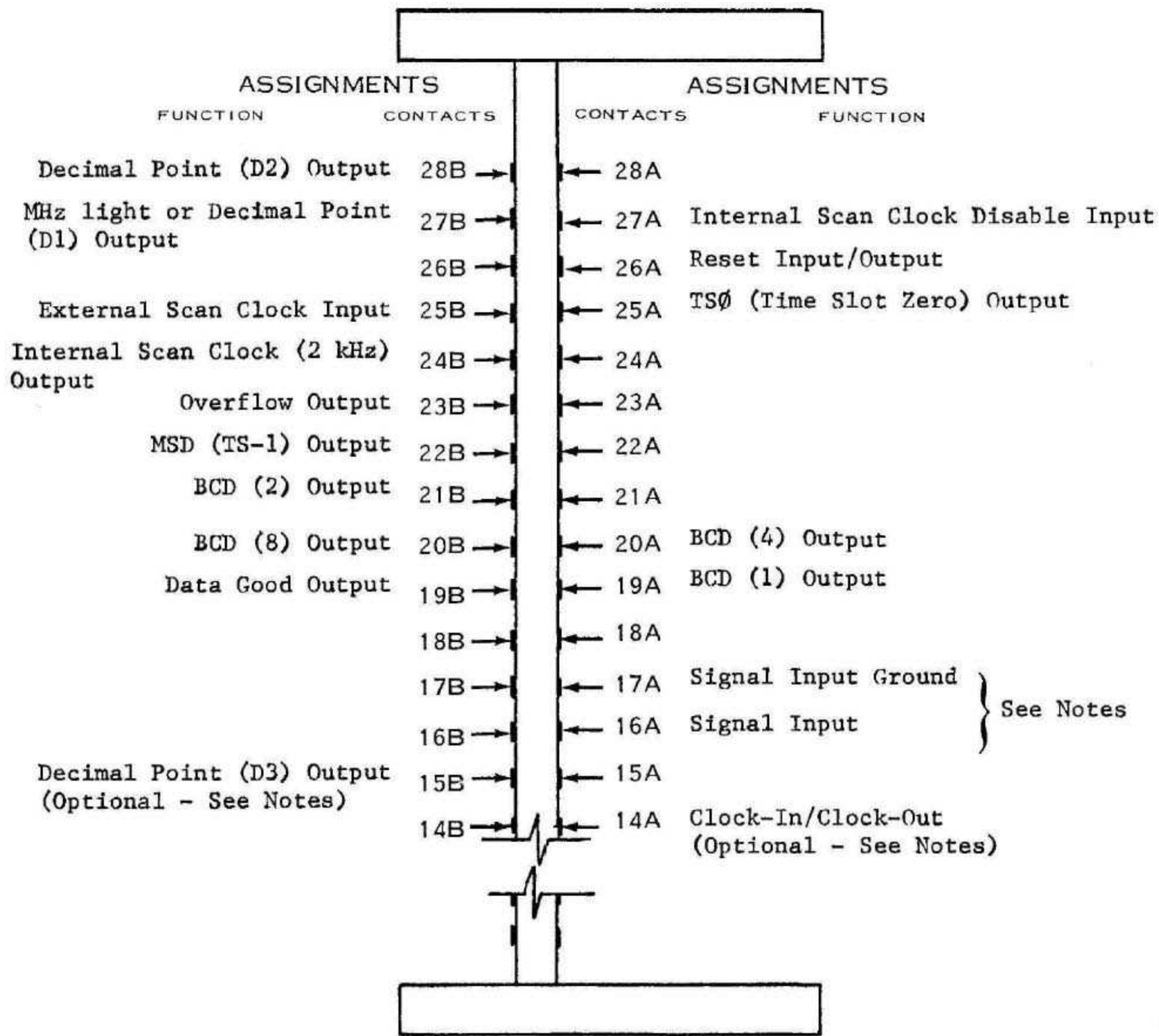

**CAUTION**

When a Power Module compartment has been selected for the DC 502 and wired for a specialized interface system, a plastic barrier (Tektronix Part Number 214-2593-02) should be installed in a key slot between contacts 21 and 22 on the Power Module.

Do not insert any TM 500 Series plug-in in a live Power Module and do not use excessive force when inserting the plug-in.



## INTERFACE NOTES

### BCD Outputs (8, 4, 2, 1 Code)

Contacts 20B, 20A, 21B and 19A provide BCD data directly to the Power Module interface. The count (front-panel display) is transmitted in a serial-by-decimal digit method, with the decimal digit sequence being from left to right (MSD to LSD as observed on the front-panel display). The binary levels for each decimal digit are expressed in positive logic (HI = 1, LO = 0). Each output data line is capable of driving 6 TTL loads (10 mA).

### Decimal Point/Front-Panel Status Outputs

TTL logic levels are transmitted directly to rear contacts 27B and 28B. The data on these contacts is related to the position of the MEASUREMENT INTERVAL switch and front-panel decimal point location. (See Table below.) Decimal points are numbered from left to right in the display. The following tables are applicable to standard DC 502 or an Option 1 instrument. All LO levels are caused by a switch-contact closure to chassis ground.

DIRECT INPUT					
CONTACT		DISPLAY			MEASUREMENT INTERVAL
27B	28B	LIGHT ON	DECIMAL POINT		
LO	LO	MHz	.0000	(D2)	.01 Sec
LO	HI	MHz	.00000	(D1)	.1 Sec
HI	HI	kHz	.000	(D3)	1 Sec
HI	LO	kHz	.0000	(D2)	10 Sec
HI	HI	Gate	000	(None)	MAN (Start)
PRESCALE INPUT					
LO	HI	MHz	.000	(D3)	.01 Sec
LO	LO	MHz	.0000	(D2)	.1 Sec
LO	HI	MHz	.00000	(D1)	1 Sec
HI	HI	kHz	.000	(D3)	10 Sec
HI	HI	Gate	000	(None)	MAN (Start)

## NOTE

*If a direct active-low level output is desired for D3 (.000), connect a #22 or #26 AWG stranded wire from the switch end of R248 to an unassigned rear contact that is compatible with your external equipment. Rear contact 15B is suggested.*

## Data Good Output (Contact 19B)

A positive-true Data Good pulse is transmitted directly to rear contact 19B at each updating of the DC 502 storage register. For an instrument with a 1 MHz clock, the pulse duration varies between 0.5 and 1.5 microseconds; a 5 MHz clock (Option 1) produces a pulse duration that varies between 0.2 and 1.2 microseconds. The Data Good output goes HI immediately after the internal gate time selected by the MEASUREMENT INTERVAL switch position. The storage register is updated on the positive-going edge of the Data Good pulse. Rear contact 19B also goes HI and remains HI as long as the MEASUREMENT INTERVAL switch is in either of the MAN (Totalize) positions. This output will drive at least 6 TTL loads.

## Reset Input/Output (Contact 26A)

This contact is directly wired to the front-panel RESET pushbutton and can be used as either a counter Reset Input or Rest Output function. Contact 26A is normally at a HI level and goes LO when the RESET button is pushed (for any position of the MEASUREMENT INTERVAL switch), or between switch detent positions. 26A does not go LO when the DC 502 clears its own internal circuitry for another count.

To use 26A as a counter Reset Input function, it can be set to a LO level by an external switch contact closure to ground or driven LO by an open-collector logic gate capable of sinking 9 TTL current loads (15 mA).

## Scan Clock Output, Input, and Disable (Contacts 24B, 25B, and 27A)

These three functions are all wired directly to rear contacts. A 2 kHz (square wave) Internal Scan Clock signal (TTL) is applied to rear contact 24B, providing a continuous output to the rear interface as long as rear contact 27A (Internal Scan Clock Disable) is held HI. The decimal digits are scanned from MSD to LSD, with the rising edge of each Scan Clock period selecting the decimal digit to be displayed. The binary levels for a selected digit remain on the BCD output lines for one complete Scan Clock period (500 microseconds for Internal Scan Clock). All of the time-slot pulses have a duration equal to a Scan Clock period. Using the Internal Scan Clock signal, it takes about 4 milliseconds for a complete display scanning cycle. The ideal time to read (decode) the BCD data is during the negative half of a Scan Clock period. This requires that an external BCD decoder be gated by the falling edge of the Scan Clock signal.



Setting rear contact 27A to a TTL LO disables the Internal Scan Clock and allows the application of an External Scan Clock signal to rear contact 25B. The External Scan Clock should be a TTL signal with a maximum frequency of 1 MHz and a fall time of less than 100 nanoseconds (frequency may be less than 2 kHz, if desired). Consequently, the time of a complete display scan and time-slot pulse duration will change accordingly.

One advantage of the External Scan Clock and Internal Scan Clock Disable inputs is to allow the user to design a BCD data capture system that extracts the data at a faster or slower rate than 2 kHz. It is not intended that a high-frequency External Scan Clock signal be applied continuously to rear contact 25B, although it can be done. A continuous 1 MHz External Scan Clock signal allows BCD data capture, but can also cause false front-panel displays.

### Time Slot Zero and MSD (Contacts 25A and 22B)

Time Slot Zero (TS $\emptyset$ ) on rear contact 25A is a TTL negative-going pulse that has a duration equal to a Scan Clock period and occurs once per complete display cycle. TS $\emptyset$  is a pulse that predicts that the next BCD data to appear on contacts 20B, 20A, 21B, and 19A will be equivalent to the most significant digit during TS-1. This pulse can be used as a synchronizing pulse for external equipment, used as a latch pulse, or as a clear/reset pulse for external digital circuitry.

The MSD (TS-1) output on rear contact 22B is a TTL positive-going pulse that also has a duration equal to a Scan Clock period and occurs once per complete display scanning cycle. Some users may prefer to use the MSD (left-side digit) pulse for synchronizing external equipment, rather than using the TS $\emptyset$  pulse. TS $\emptyset$  and MSD (TS-1) are the only time-slot pulses directly wired to the rear contacts.

### Overflow Indication (Contact 23B)

Rear contact 23B is normally at a LO level. This contact goes HI under two conditions: (1) when the DC 502 is operated in a MAN (Totalize) mode and the storage registers are full of nines (9999999 display), contact 23B goes HI on the next input count; (2) when making high-resolution frequency measurements by increasing the MEASUREMENT INTERVAL by a factor of 10 or greater. Contact 23B is HI any time that the front-panel OVERFLOW light is on.

### Signal Input (Contacts 16A and 17A)

#### NOTE

*It is important to consider VSWR and cross-talk problems at high frequencies. Pay particular attention to lead dress, terminations, and discontinuities along a high-frequency signal path.*

Rear contacts 16A and 17A are not directly wired to the input and ground

circuits of the DC 502. 16A is reserved for Signal Input and 17A is reserved for Signal Input Ground.

When applying input signals through the rear interface, it is necessary to connect the center conductor (stranded wire) of a miniature 50-ohm coaxial cable from 16A to the DIRECT INPUT solder connection on the B side of the instrument. Connect both ends of the coaxial cable shield, one end to 17A and the other end to a convenient ground on the circuit board near the DIRECT INPUT connection. There is no switching system available to switch between front-panel input and rear interface signals; therefore, if it is not desired to transmit front-panel signals to the rear interface, disconnect the lead to the DIRECT INPUT BNC connector. The coaxial cable can be terminated into a 50 load, if desired. Contact 17A must also be grounded (externally) in an Option 2 Power Module.

Most instruments have solder pad connections for 16A and 17A located on the B side of the circuit board, while earlier instruments require direct connections to 16A and 17A on the A side of the circuit board. Refer to illustration.

Contacts 16A and 17A can also be wired to the PRESCALE INPUT circuit board on the A side of the instrument, if desired. Remove the cable to the PRESCALE INPUT BNC connector in order to maintain a clean 50-ohm environment.

#### Clock-In/Clock-Out (Optional - Contact 14A)

Rear contact 14A can be used for a higher quality in-house Clock Input, or as a 1 MHz Clock Output, as desired. Connect a miniature 50-ohm coaxial cable between pin 14 or U209 and rear contact 14A. Pin 14 of U209 operates at TTL levels. Ground both ends to the coaxial-cable shield; one end to rear contact 17A and the other end to pin 7 of U209, U200, or U201. When 14A is used as a Clock Input for a standard DC 502, remove U200 from the circuit board; for an Option 1 instrument, remove U201.

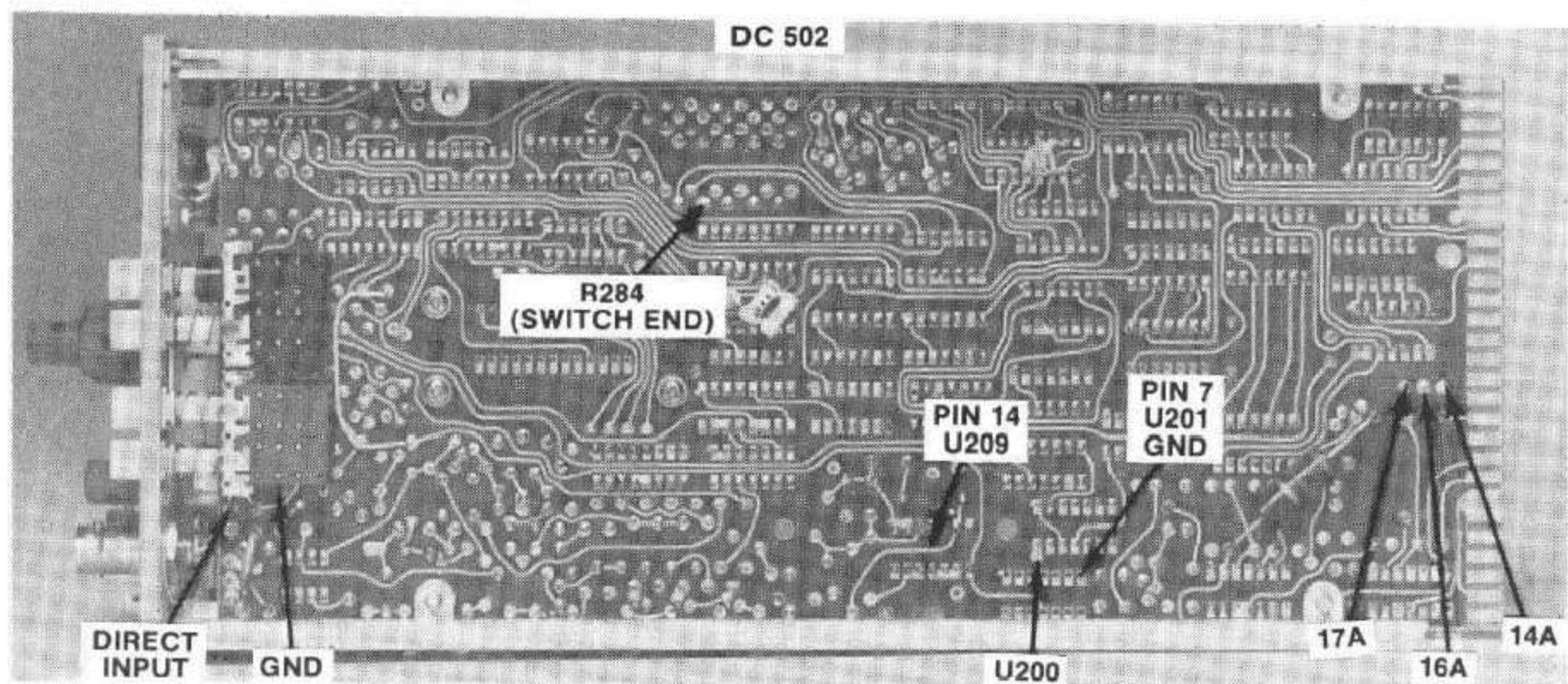





## Plug-In or Power Module Rear View

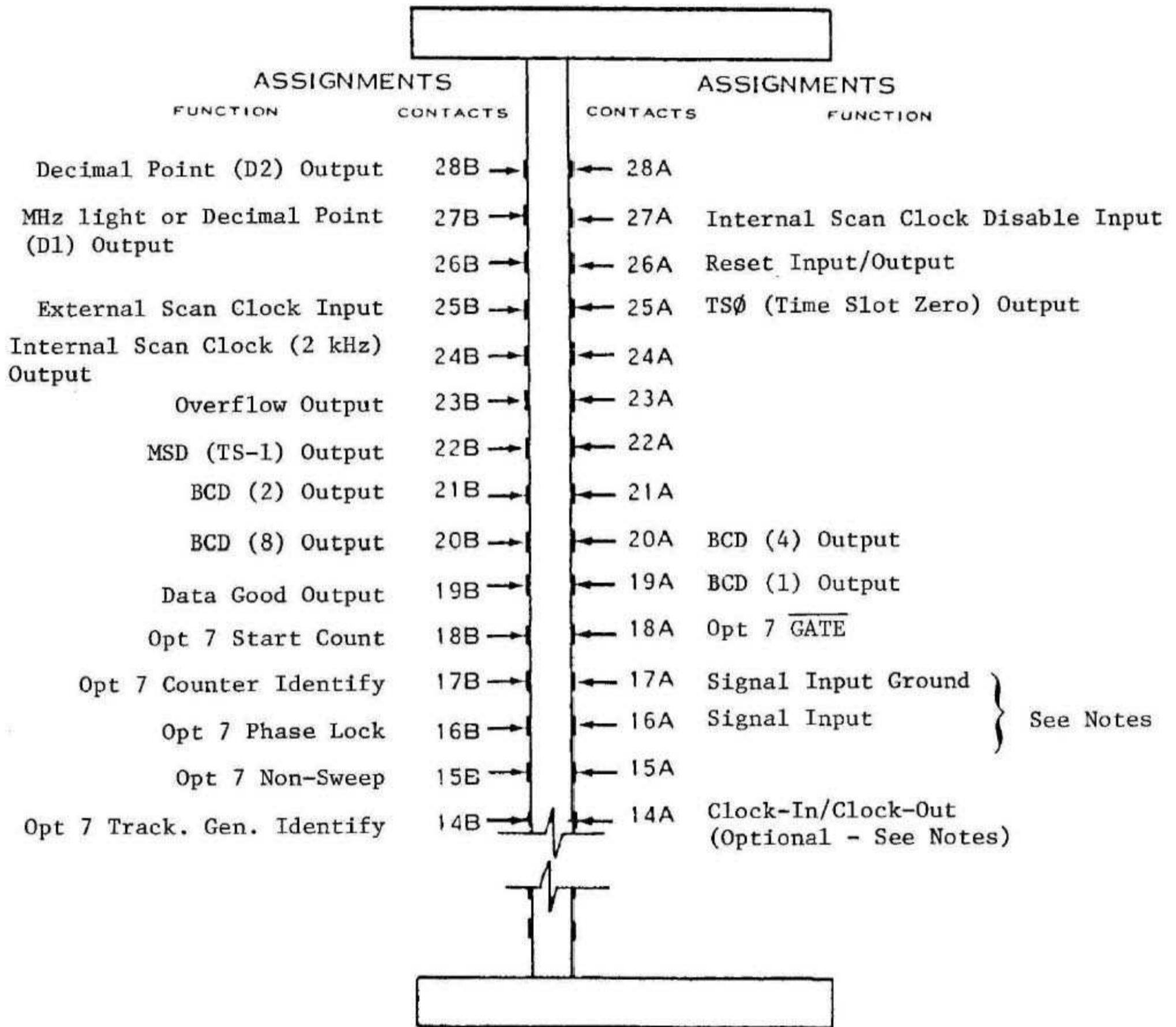

### CAUTION

When a Power Module compartment has been selected for the DC 502 and wired for a specialized interface system, a plastic barrier (Tektronix Part Number 214-2593-02) should be installed in a key slot between contacts 21 and 22 on the Power Module.

Do not insert any TM 500 Series plug-in in a live Power Module and do not use excessive force when inserting the plug-in.

Option 7 (Contacts 18A, 18B, 17B, 16B, 15B, and 14B)

These contacts are factory wired for a DC 502 Option 7 instrument. The DC 502 Option 7 is an Option 1 instrument to which an additional logic circuit board has been added plus some circuit modifications. The DC 502 Option 7 was designed to operate with a spectrum analyzer and a tracking generator to provide an accurate readout of the spectrum analyzer's center frequency. When the DC 502 Option 7 instrument is used with this system it must be installed in a specific compartment of a TM 500-Series Option 7 Power Module. Refer to the instruction manuals for the DC 502 Digital Counter and TR 502 Tracking Generator for more information.

## Plug-In or Power Module Rear View

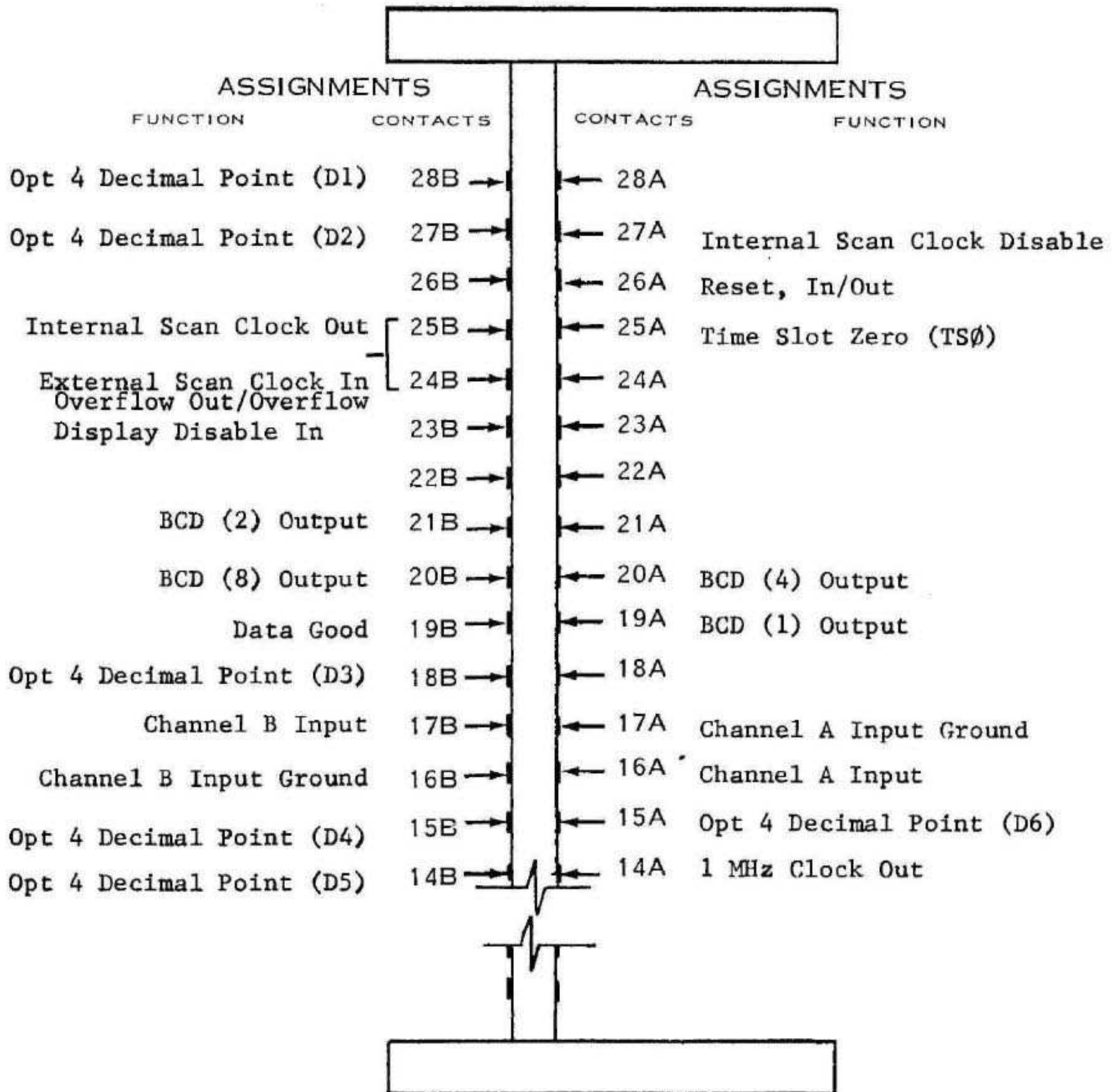

**CAUTION**

When a Power Module compartment has been selected for the DC 503 and wired for a specialized interface system, a plastic barrier (Tektronix Part Number 214-1593-02) should be installed in a key slot between contacts 21 and 22 on the Power Module.

Do not insert any TM 500 Series plug-in in a live Power Module and do not use excessive force when inserting the plug-in.



## INTERFACE NOTES

### BCD Outputs (8,4,2,1 Code)

Contacts 20B, 20A, 21B, and 19A provide BCD data directly to the Power Module interface. The count (front-panel display) is transmitted in serial-by-decimal digit sequence. The decimal digit sequence is from left to right (MSD to LSD as observed on the front-panel readout). The binary levels for each decimal digit use positive-true logic (HI = 1, LO = 0). Each output data line is capable of driving 6 TTL loads (10 mA).

### Decimal Point Output Data

There are six decimal points associated with the front-panel display, numbered from left to right in the readout. An active decimal point location is dependent on the positions of two front-panel switches (FUNCTION and N/CLOCK RATE).

Decimal point output data is factory wired to rear contacts only for an Option 4 instrument. A rear contact is at a TTL low level when the associated front-panel decimal point is active.

To obtain decimal point output data for instruments other than Option 4, a unit can be hard-wired by performing the decimal modification section of the instructions included with Product Modification Kit, Tektronix Part Number 040-0713-00.

### Data Good Output (Contact 19B)

A positive-true Data Good pulse is transmitted directly to rear contact 19B at each updating of the DC 503 storage register. Pulse duration is from a minimum of 0.2 microseconds to a maximum of 1.5 microseconds, dependent on the clock option. The storage register is updated on the positive-going edge of the Data Good pulse. The Data Good pulse goes HI immediately after an internal gate time selected by the FUNCTION or N/CLOCK rate switches (dependent on the operating mode). Contact 19B also goes HI and remains HI as long as the FUNCTION switch is in either the TIME MANUAL or TOTALIZE A positions. This output will drive at least 6 TTL loads.

### Reset Input/Output (Contact 26A)

The counter is cleared to zero when a LO is applied to contact 26A. This is accomplished when the front-panel RESET button is pushed, or when the FUNCTION switch is between detent positions. Contact 26A also goes LO momentarily during an automatic power-up reset period. This contact does not go LO when the DC 503 internal circuitry clears itself for another count. To use

26A as a Reset Input function, it can be set to a LO by an external switch contact closure to ground, or driven LO by an open-collector logic gate capable of sinking 15 mA.

#### Scan Clock Output/Input and Disable (Contacts 24B/25B and 27A)

Contacts 24B/25B are hard-wired together at the rear edge connectors. A 2 kHz (square wave) Internal Scan Clock signal is applied to these two contacts as long as contact 27A (Internal Scan Clock Disable) is held HI. A LO applied to contact 27A allows contacts 24B/25B to be used as an External Scan Clock Input.

The decimal digits are scanned from MSD to LSD (as observed on the front-panel display), with the rising edge of each Scan Clock period selecting the decimal digit to be displayed. The binary levels for a selected digit remain on the BCD output lines for one complete Scan Clock period (500 microseconds for Internal Scan Clock signal). Using the Internal Scan Clock signal it takes about 4 milliseconds for one complete display scanning cycle. The ideal time to read (decode) the BCD data is during the negative portion of the Internal Scan Clock period.

The risetime of an External Scan Clock signal applied directly to 24B/25B should be less than 100 nanoseconds. Signal inversion does not occur before toggling a divide by 8 counter circuit. Note that changing a Scan Clock period changes the time-slot duration and the time of one complete display scanning cycle. Maximum External Scan Clock frequency is 1 MHz. Refer to the time-ladder diagram for waveform relationships between the Internal Scan Clock, TS $\emptyset$  pulse, and Internal Scan Clock Disable pulse. The DC 503 has no TS-1 through TS-7 output to the rear interface.

#### Time Slot Zero (Contact 25A)

Time Slot Zero (TS $\emptyset$ ) on rear contact 25A is a TTL negative-going pulse that has a duration equal to a Scan Clock period and occurs once per complete display scanning cycle. TS $\emptyset$  is a pulse which predicts that the next BCD data to appear on the BCD output lines will be equivalent to the most significant digit during TS-1. This pulse can be used as a synchronizing pulse for external equipment.

#### Overflow and Leading Zero Suppression (Contact 23B)

Rear contact 23B goes LO and HI and about a 3 Hz rate when the DC 503 is in an overflow condition. A LO corresponds to "display blanked" and HI

corresponds to "display on". 23B can be driven LO externally to blank the front-panel display. When the display is not in an overflow condition a LO will exist during periods of leading zero suppression.

#### 1 MHz Clock Out/Clock In (Contact 14A)

Rear contact 14A can be used as a 1 MHz Clock Out/Clock In function. Use contact 17A as a reference ground. When contact 14A is used as a more accurate Clock In function, remove U250 from the circuit board (standard instrument), or remove U251 for an Option 1 instrument.

#### Signal Inputs (Contacts 16A and 17B)

Rear contact 16A is assigned for Channel A input, with 17A its reference ground. 17B is assigned for Channel B input, with 16B its reference ground. When it is desired to apply input signals to these rear interface contacts for counter operation, the appropriate channel must be selected by the front-panel SOURCE switches. The internal signal inputs are terminated into a nominal 50 ohm load impedance to match coaxial-cable connections to the rear interface. For high impedance ( $1M\Omega$ ) rear inputs, one end of either or both 50  $\Omega$  resistors may be lifted. The resistors are physically located at the push-pull input-output switches at the front panel.



## Plug-In or Power Module Rear View

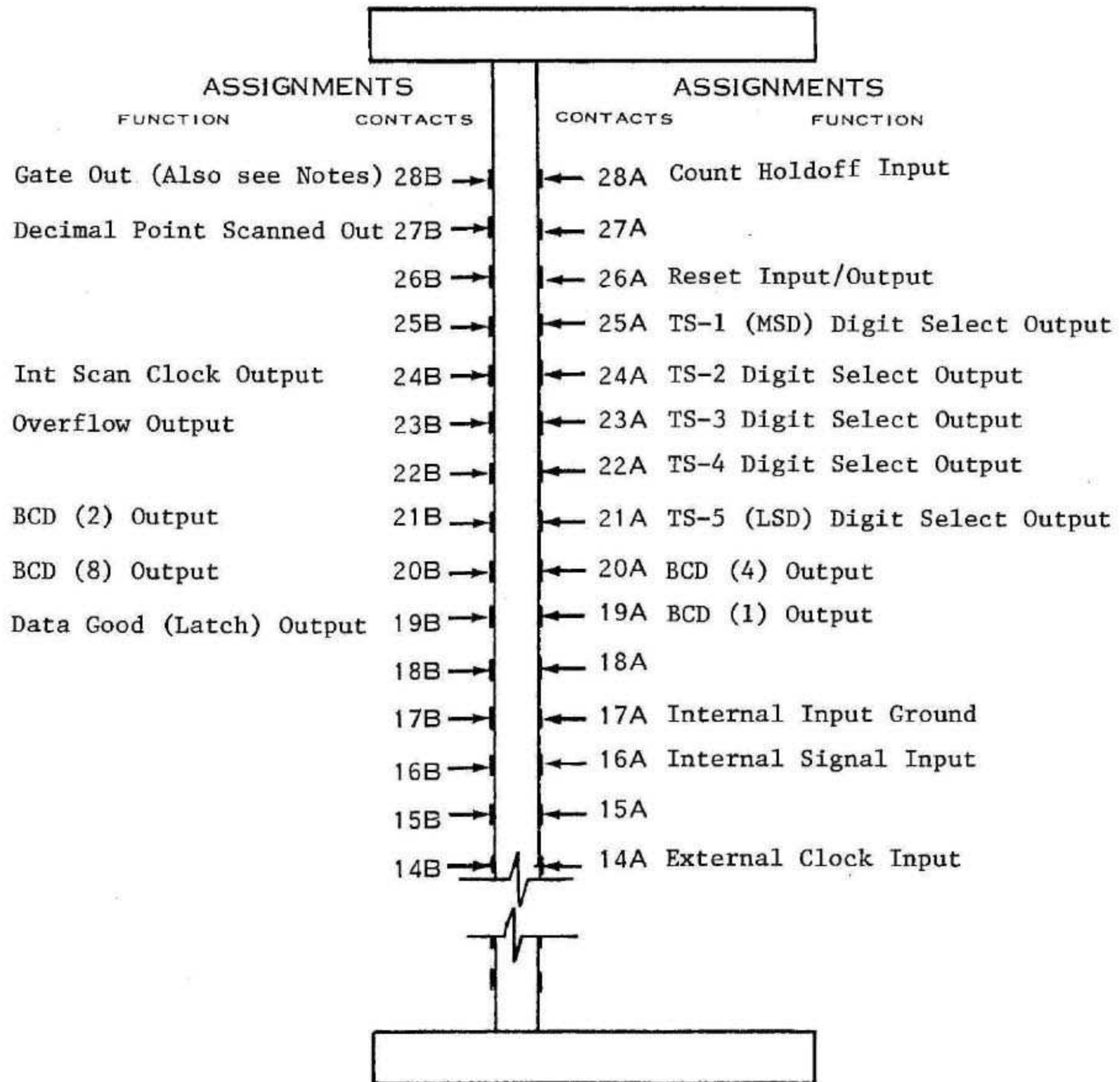

## CAUTION

*When a Power Module compartment has been selected for the DC 504 and wired for a specialized interface system, a plastic barrier (Tektronix Part Number 214-1593-02) should be installed in a key slot between contacts 21 and 22 on the Power Module.*

*Do not insert any TM 500 Series plug-in in a live Power Module and do not use excessive force when inserting the plug-in.*

## INTERFACE NOTES

### BCD Output Data (Contacts 20B, 20A, 21B, and 19A)

These contacts provide BCD data (8,4,2,1 code) directly to the Power Module interface. The count (front-panel display) is transmitted in serial-by-decimal digit sequences. The decimal digit sequence is from left to right (MSD to LSD as observed on the front-panel display). The binary levels for each decimal digit use positive-true logic (HI = 1, LO = 0). Each output data line is capable of driving 6 TTL loads (10 mA).

### Decimal Point Scanned Output (Contact 27B)

Three decimal points are numbered from left to right in the front-panel display. A decimal point to the left of a selected digit is scanned (made active) during its particular time slot. Contact 27B goes HI and remains HI for one Scan Clock period to indicate that a decimal point has been scanned. When the DC 504 is used in the RPM mode (internal switch function), the decimal points are not active and 27B remains at a LO level. This data line will drive 24 TTL loads (38 mA).

### Digit Select Outputs (Contacts 25A through 21A)

These output lines provide positive-going time-slot pulses TS-1 (MSD) through TS-5 (LSD) to the rear interface. The time-slot pulses scan the front-panel decimal digits from left to right. Each time-slot pulse duration is equal to one Scan Clock period (about 0.25 milliseconds). There is no TS $\emptyset$  pulse that occurs before the MSD data appears on the BCD output lines. Each Digit Select line will drive 4 TTL loads (6.4 mA).

### Scan Clock Output (Contact 24B)

This output line provides a square-wave signal of about 4 kHz to the rear interface. A different front-panel digit is selected to be displayed on each rising edge of the Scan Clock waveform. A ideal time to externally read (decode) the BCD output data for a selected digit is on each falling edge of the Scan Clock signal. Refer to the DC 504 Instruction Manual for waveform relationships. This output data line will drive only 1 TTL load (1.6 mA).

## Data Good Output (Contact 19B)

This output line provides a positive Data Good (Latch) pulse to the rear interface. The pulse duration is about 10 microseconds and occurs as each updating of the display storage register. In a Latch Override mode (internal switch function), contact 19B remains HI during a selected measurement interval. This data line will drive 10 TTL loads (16 mA).

## Overflow Output (Contact 23B)

Contact 23B is normally at a LO level and goes HI to indicate that the counter is in an overflow condition. Contact 23B is at a HI level any time that the front-panel OVERFLOW light is on. This output data line will drive 8 TTL loads (12.8 mA).

## Reset Input/Output (Contact 26A)

The counter is cleared to zero when a LO is applied to 26A. This is accomplished from the front-panel by pushing the RESET button or setting the FUNCTION switch between detents. When used as an output, this line will drive 6 TTL loads (10 mA). 26A also goes LO momentarily during power-up reset, when the counter prepares itself for operation. 26A does not go low when the internal circuitry clears itself for another count.

When contact 26A is used as a Reset Input function, the external circuit must be able to drive 9 TTL loads; a discrete transistor capable of sinking 15 mA can be used.

## Gate Out/TOTALIZE Stop (Contact 28B)

Contact 28B has Two assignments.

1. It provides a Gate Out signal that is HI during the time that an internal gate is open (while an input signal is gated into the decade counter units). This output line will drive 5 TTL loads (9 mA).
2. When the DC 504 is operated in the TOTALIZE mode, 28B can be pulled LO to inhibit the gate (stop the counting). When used as an input line, the external circuitry must be capable of sinking 5 mA (3 TTL). Open-collector logic or a discrete transistor without a pull-up resistor is recommended to set 28B to a LO.



## Digital Counters—DC 504

If contact 28B is pulled LO in any mode other than TOTALIZE, the counting will stop and the front-panel display will go to zero after a time determined by the DISPLAY TIME control. Forcing 28B to a HI causes the internal gate to remain open in all operating modes.

### Count Holdoff Input (Contact 28A)

This input line drives the base of a transistor and one input line to a TTL logic gate. The application of a HI level to 28A forces the DC 504 into a hold mode. The counter will hold the latest measurement and will take another count only after the RESET button is pushed, the FUNCTION switch is rotated, or when the Count Holdoff signal to 28A goes LO. Your external circuit to 28A must be able to drive 3 TTL loads (Fan In).

### Internal Signal Input (Contacts 16A and 17A)

Input signals can be applied through the rear interface via contact 16A, with 17A serving as a ground reference (coaxial-cable shield connection). To select input signals via contact 16A, set the front-panel SOURCE switch to the INT position. The input signals are dc or ac coupled, dependent upon the selected position of an internal switch. Contact 16A is terminated with a nominal 50-ohm load impedance. R100 can be removed to convert the input impedance to 1 M $\Omega$ , if desired.

### External Clock Input (Contact 14A and 17A)

An External Clock signal can be used instead of the internal 1 MHz clock by applying the input to 14A and using 17A to ground a coaxial-cable shield. To use the External Clock signal, set the internally located Int/Ext switch to the EXT position and use a shielded cable to connect between the solder pads marked EO on the circuit board.

The External Clock input is somewhat duty-cycle sensitive. It is recommended that the positive portion of this input signal have a duty cycle of at least 15%, but not more than 70%. Refer to the DC 504 Instruction Manual for more information. At present, there is no direct connection to any rear contact to provide a 1 MHz Clock signal output.

## Plug-In or Power Module Rear View

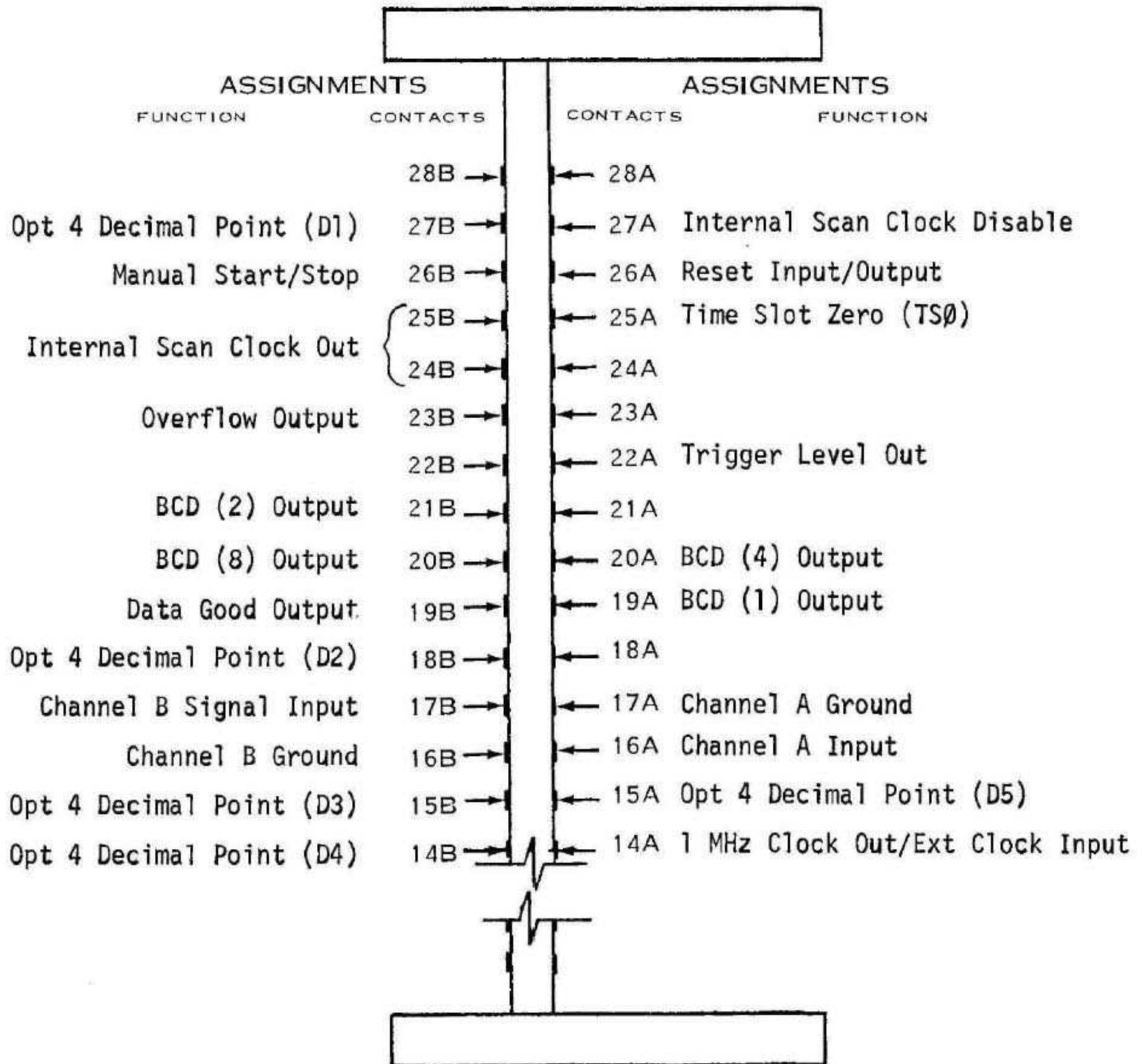

### CAUTION

*When a Power Module compartment has been selected for the DC 505 and wired for a specialized interface system, a plastic barrier (Tektronix Part Number 214-1593-02) should be installed in a key slot between contacts 21 and 22 on the Power Module.*

*Do not insert any IM 500 Series plug-in in a live Power Module and do not use excessive force when inserting the plug-in.*

## INTERFACE NOTES

### BCD Outputs (8,4,2,1 Code)

Contacts 20B, 20A, 21B, and 19A provide BCD data directly to the Power Module interface. The count (front-panel display) is transmitted in serial-by-decimal digit sequence. The decimal digit sequence is from left to right (MSD to LSD as observed on the front-panel readout). The binary levels for each decimal digit use positive-true logic (HI = 1, LO = 0). Each output data line is capable of driving 6 TTL loads (10 mA).

### Decimal Point Output Data

There are five decimal points associated with the front-panel display, dependent upon the position of the front-panel controls (see Instruction Manual). An active decimal point location is numbered from left to right in the front-panel readout.

Decimal point output data is factory wired to the rear contacts only for an Option 4 instrument. A rear contact is at a TTL LO level when the associated front-panel decimal point is active.

To obtain decimal point output data for instruments other than Option 4, a unit can be user wired by performing the decimal point modification section of the instructions included with Product Modification Kit, Tektronix Part Number 040-0713-00.

### Data Good Output (Contact 19B)

A positive-true Data Good pulse is transmitted directly to contact 19B at each updating of the DC 505/DC 505A storage register. Pulse duration is from a minimum of 0.2 microseconds to a maximum of 1.5 microseconds, dependent upon the clock option. The storage register is updated on the positive going edge of the Data Good pulse. Contact 19B goes HI immediately after an internal gate time as selected by the front-panel controls. Contact 19B also goes HI and remains HI as long as the DC 505/DC 505A is operated in the TOTALIZE A mode.

### Reset Input/Output (Contact 26A)

The counter is cleared to zero when a LO is applied to contact 26A. This is accomplished when the front-panel RESET button is pushed, or when the FUNCTION switch is between detents. Contact 26A also goes LO momentarily during a power-up reset period. This contact does not go LO when the DC 505/DC 505A internal circuitry clears itself for another count. To use 26A as a Reset Input function, set it to a LO by an external switch closure to ground, or drive it LO by an open-collector logic gate capable of sinking 15 mA.



## Int Scan Clock Output/Int Scan Clock Disable (Contacts 24B/25B and 27A)

Contacts 24B/25B are hard wired together at the rear edge connectors. The Int Scan Clock signal (2 kHz square wave) is present on 24B/25B as long as 27A (Int Scan Clock Disable) is held HI (or open). A LO applied to 27A will disable the Int Scan Clock circuit. At present, it is not recommended to apply an External Scan Clock signal to 24B/25B when disabling the Int Scan Clock.

The decimal digits are scanned from MSD to LSD (as observed on the front-panel display), with the rising edge of each Scan Clock period selecting the decimal digit to be displayed. The binary levels for a selected digit remain on the BCD output lines for one complete Scan Clock period (500 microseconds). An ideal time to externally read (decode) the BCD data is during the negative portion of the Internal Scan Clock period.

## Time Slot Zero (Contact 25A)

Time Slot Zero (TS $\emptyset$ ) on rear contact 25A is a TTL negative-going pulse that has a duration equal to a Scan Clock period and occurs once per complete display scanning cycle. TS $\emptyset$  is a pulse which predicts that the next BCD data to appear on the BCD output lines will be equivalent to the most significant digit during TS-1. This pulse can be used as a synchronizing pulse for external equipment.

## Overflow and Leading Zero Suppression (Contact 23B)

Rear contact 23B is normally at a HI level and goes LO and HI at about a 3 Hz rate when the DC 505 is in an overflow condition. A LO corresponds to "display on". 23B can be driven LO to completely blank the front-panel display (all digits). When the display is not in an overflow condition, a LO will exist during periods of leading zero suppression.

## 1 MHz Clock Out/Ext Clock Input (Contact 14A)

An internal switch position determines whether contact 14A provides a 1 MHz Clock Output or is used as a more accurate Ext Clock Input. In either case, coaxial cable should be used for this connection (using contact 17A as a shield ground).

## Signal Inputs (Contacts 16A-17A and 17B-16B)

Selection of Channel A (16A) or Channel B (17B) signal inputs are controlled by front-panel LEVEL/SOURCE switches. Signals applied through the rear interface are terminated into a nominal 50-ohm load impedance to match coaxial cable connections. Use contacts 17A and 16B as coaxial-cable shield ground connections. R210 or R100 can be removed to convert the input impedance to 1 M $\Omega$ , if desired.

### Manual Start/Stop (Contact 26B)

Contact 26B is normally at a TTL HI level. A TTL LO applied to this contact will open an internal gate to allow counting. Contact 26B should be wired and used in the TOTALIZE A mode only. In other modes of operation, 26B is not locked out and if a LO is applied for these modes; the result will be a variety of erroneous displays.

### Trigger Level Out (Contact 22A)

This contact has a dc voltage range (-2 V to +2 V) which allows monitoring (with a DVM) the triggering level of signals applied to CH A or CH B. A front-panel switch determines whether the dc output on contact 22A is for CH A or CH B. For the DC 505A this output is factory wired. For a DC 505 that does not have this feature, you can order and install a Trigger Level Out Modification Kit Number 040-0757-00.

**SECTION 7**  
**DIGITAL DELAY UNITS**





## Plug-In or Power Module Rear View

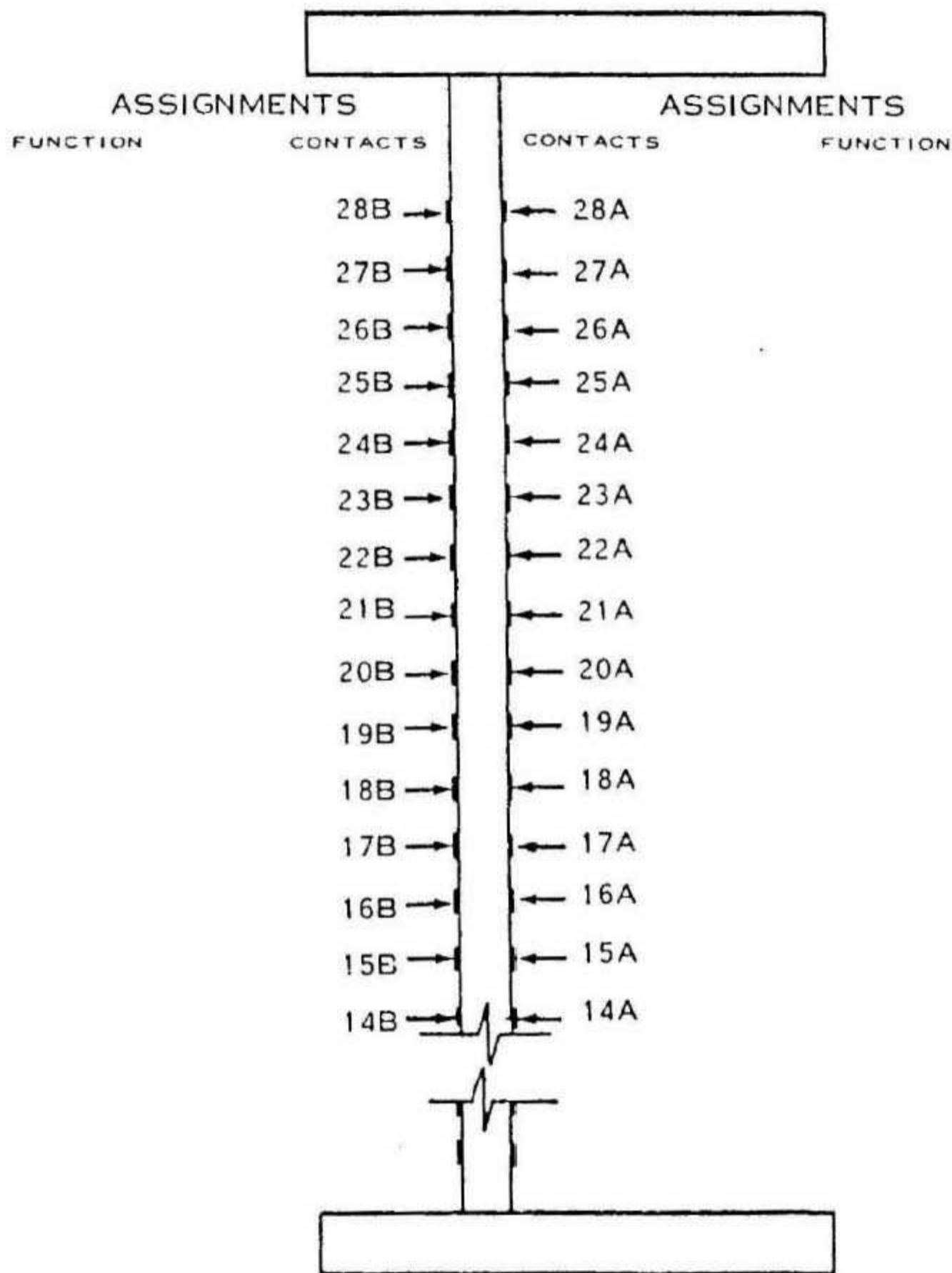

Each Rear Interface Connection shown has its own through-hole-plated connection pad.

**CAUTION**

*When a Power Module compartment has been selected for the DD 501 and wired for a specialized interface system, (Option 7) a plastic barrier (Tektronix Part Number 214-1593-02) should be installed in a key slot between contacts 21 and 22 on the Power Module.*

*Do not insert any TM 500 Series plug-in in a live Power Module and do not use excessive force when inserting the plug-in.*

**SECTION 8**  
**DIGITAL METERS**





## Plug-In or Power Module Rear View

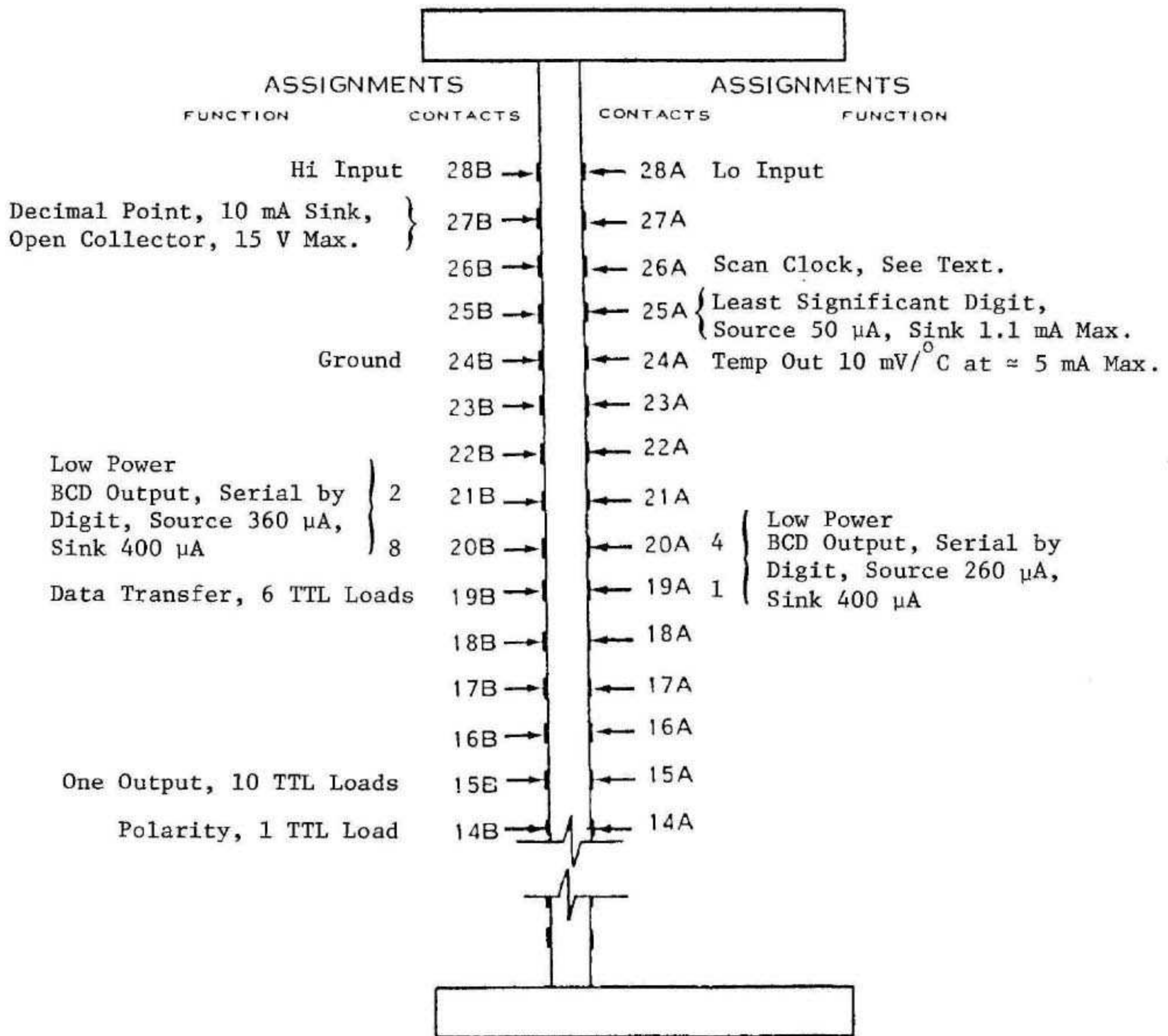

### CAUTION

When a Power Module compartment has been selected for the DM 501 and wired for a specialized interface system, a plastic barrier (Tektronix Part Number 214-1593-02) should be installed in the key slot between contacts 17 and 18 on the Power Module. Early production DM 501's may have the key slot between contacts 21 and 22.

Do not insert any TM 500 Series plug-in in a live Power Module and do not use excessive force when inserting the plug-in.

## INTERFACE NOTES

### Introduction

Display logic, temperature readout simultaneous with the front panel output and external input are available at the rear interface connector.

### Display Details

The display is sequentially scanned starting with the least significant digit and ending with the second most significant digit. The most significant digit and polarity signs are not scanned in time sequence. They are determined when the count is transferred to the latches and are not updated until the next data transfer. All digits display numbers from 0 through 9 with the exception of the most significant digit. This digit displays either a 1 or 0. The plus or minus sign is also included within this digit module. All digits except the most significant digit have similar segments connected together. These segments are driven from a BCD to seven segment decoder driver. The BCD data is available at the rear interface connector.

### Buffering Output Terminals

The assignments diagram lists the loads each rear interface output terminal is capable of driving. Buffers may be required depending on the load requirements. A 74L04 low power TTL chip with six inverters per chip may suffice. For a non-inverted output use a CMOS buffer such as a CD4050. If buffering is required on only one output line, use a transistor such as the 2N2222A.

### Assignments Description

Hi and Lo Input (28B and 28A). When the front panel INPUT switch is pushed in, the HI and LO inputs are transferred from the front panel to the rear interface connections. These contacts are floating. Maximum voltage on either input should not exceed 350 V measured from ground.

Decimal Point (27B). Connect a 5.1 k $\Omega$  resistor from this pin to +5 V. This terminal connects directly to the collector of Q340. This terminal is high when the displayed digit requires a decimal point to its left.

Scan Clock (26A). This is a 4 kHz signal used to step the display through the digit sequence as described earlier. See Fig. 2. Buffer this output with a non-loading device (CMOS).

Least Significant Digit (25A). This terminal goes high when the data on the BCD lines applies to the least significant digit.

BCD Output Lines (19A, 20A, 20B, 21B). These lines present the data in bit parallel character serial fashion.

Data Transfer (19B). This line goes high when the count accumulated in the cascaded counters transfers to the five 4-bit latches. The first lsd pulse (high) after Data Transfer goes low may be used to start the display sequence.

One Output (15B). This line goes low when the 1 in the msd module is illuminated.

Polarity (14B). This connection is low when the vertical bars in the polarity sign are illuminated.

Temperature Readout (24A and 24B Ground). These connections are in parallel with the front panel TEMP OUT terminals. The voltage available is 10 mV/degree.

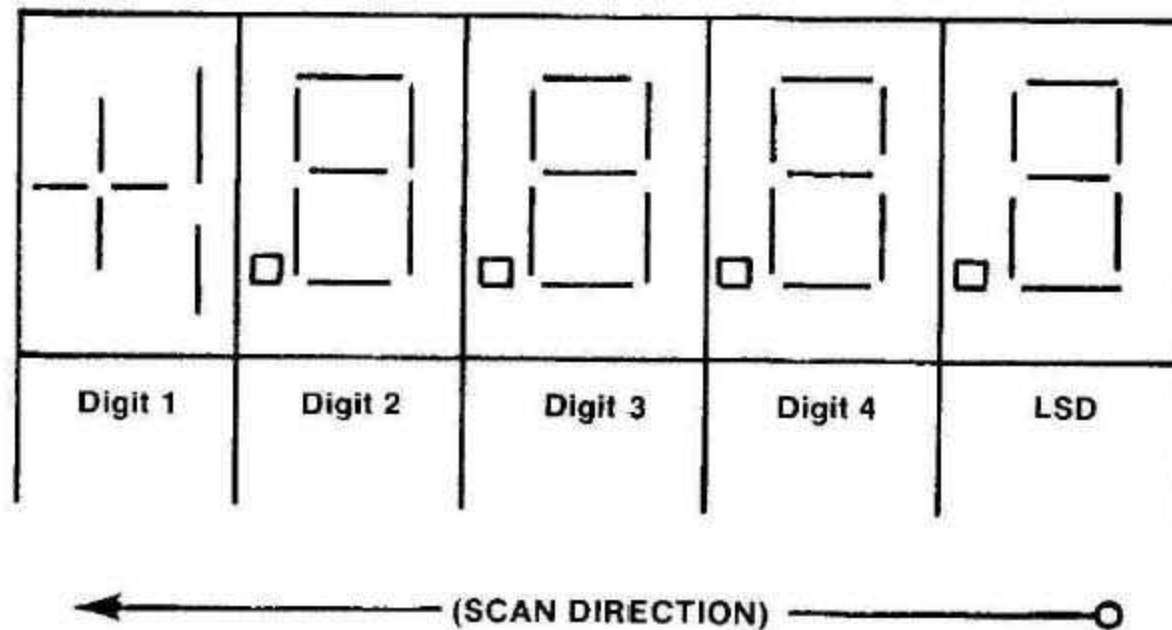

FIG. 1



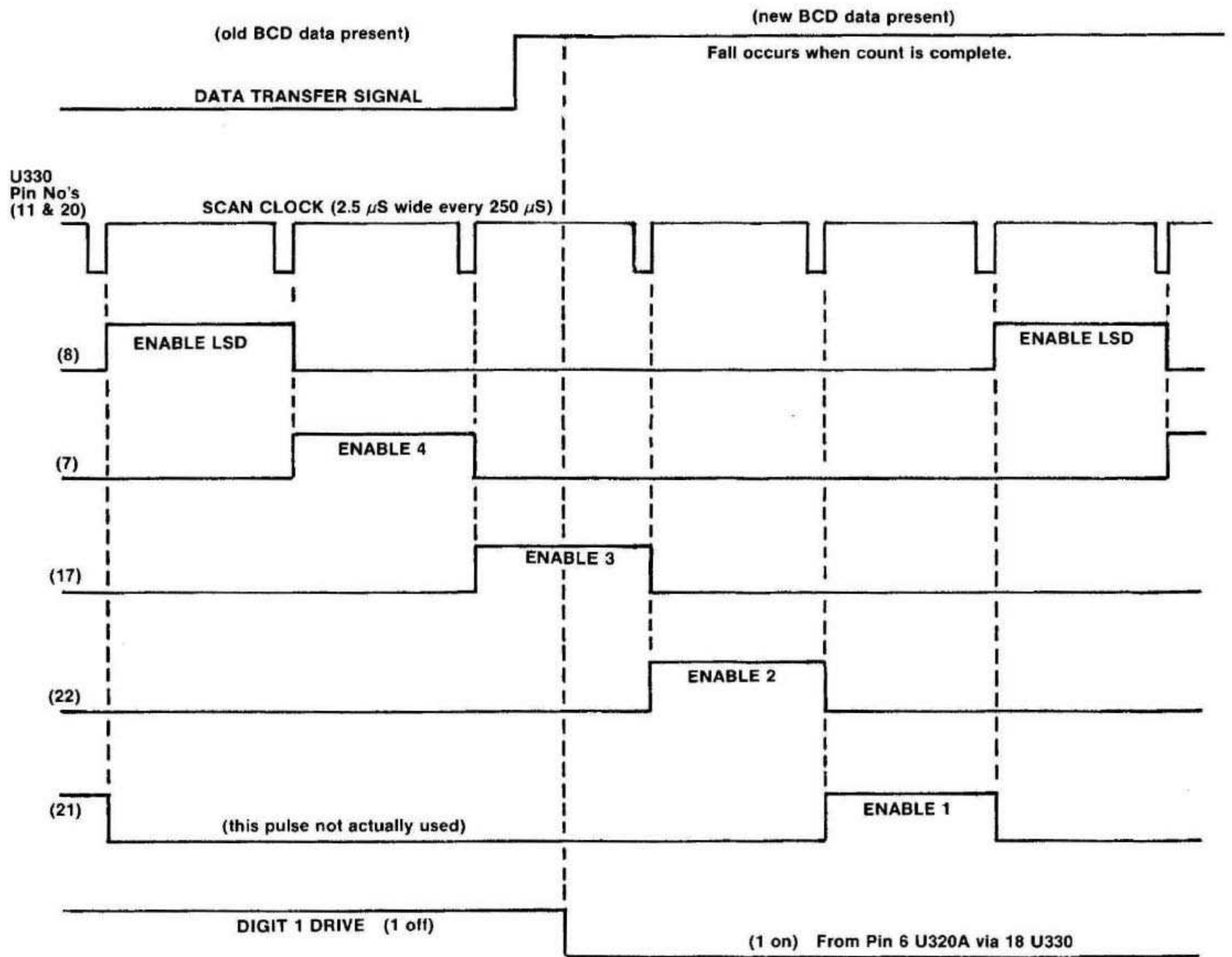

FIG. 2

SUGGESTED DATA INTERFACE FOR DM 501

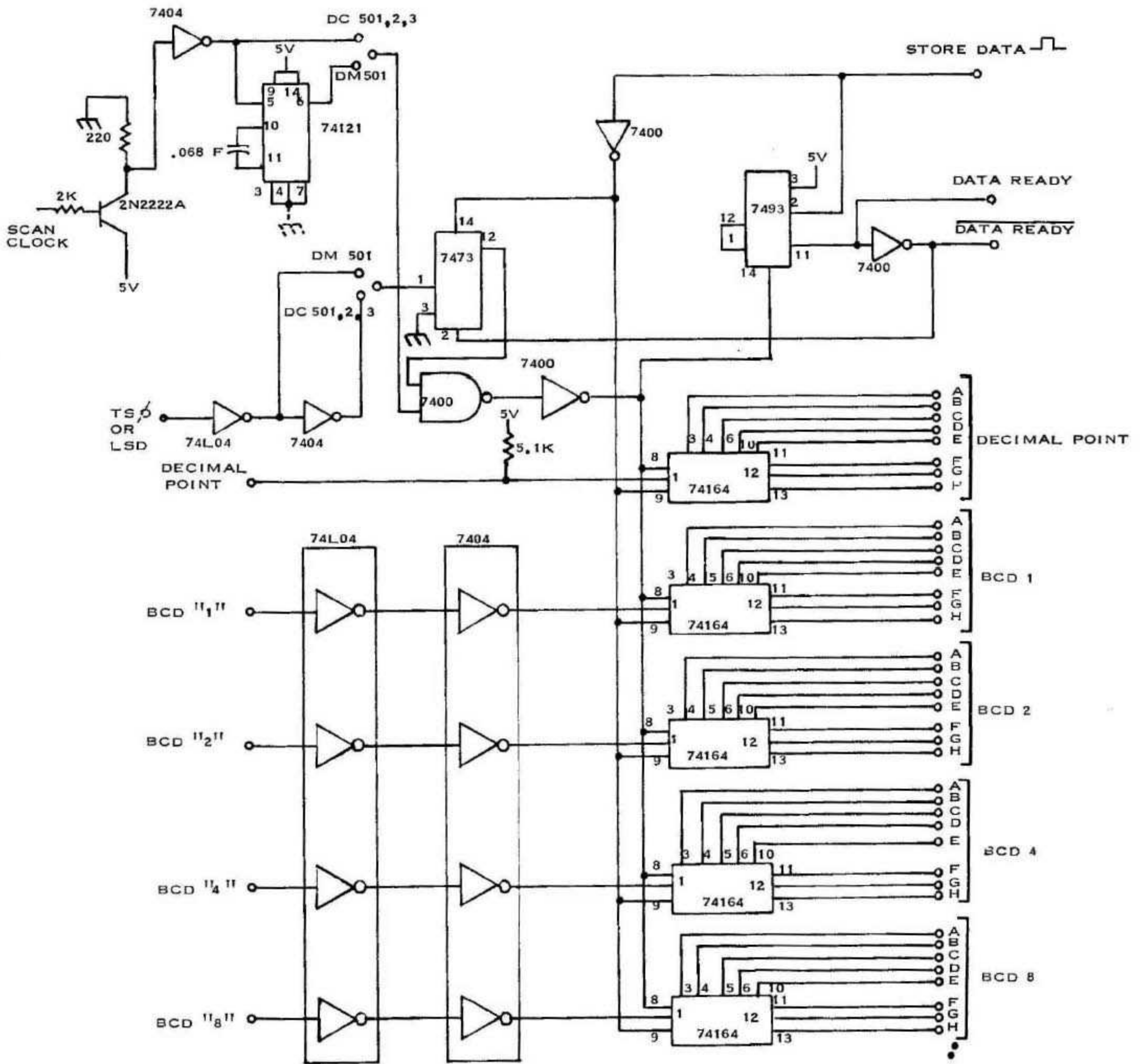

FIG. 3

OUTPUT TERMINAL ASSIGNMENTS  
 D E F G H  
 (ABC outputs not used)

NOTES

Registers are cleared when "STORE DATA" is high. Storage begins when "STORE DATA" goes low. Valid Data is available when "DATA READY" goes high.



## Plug-In or Power Module Rear View

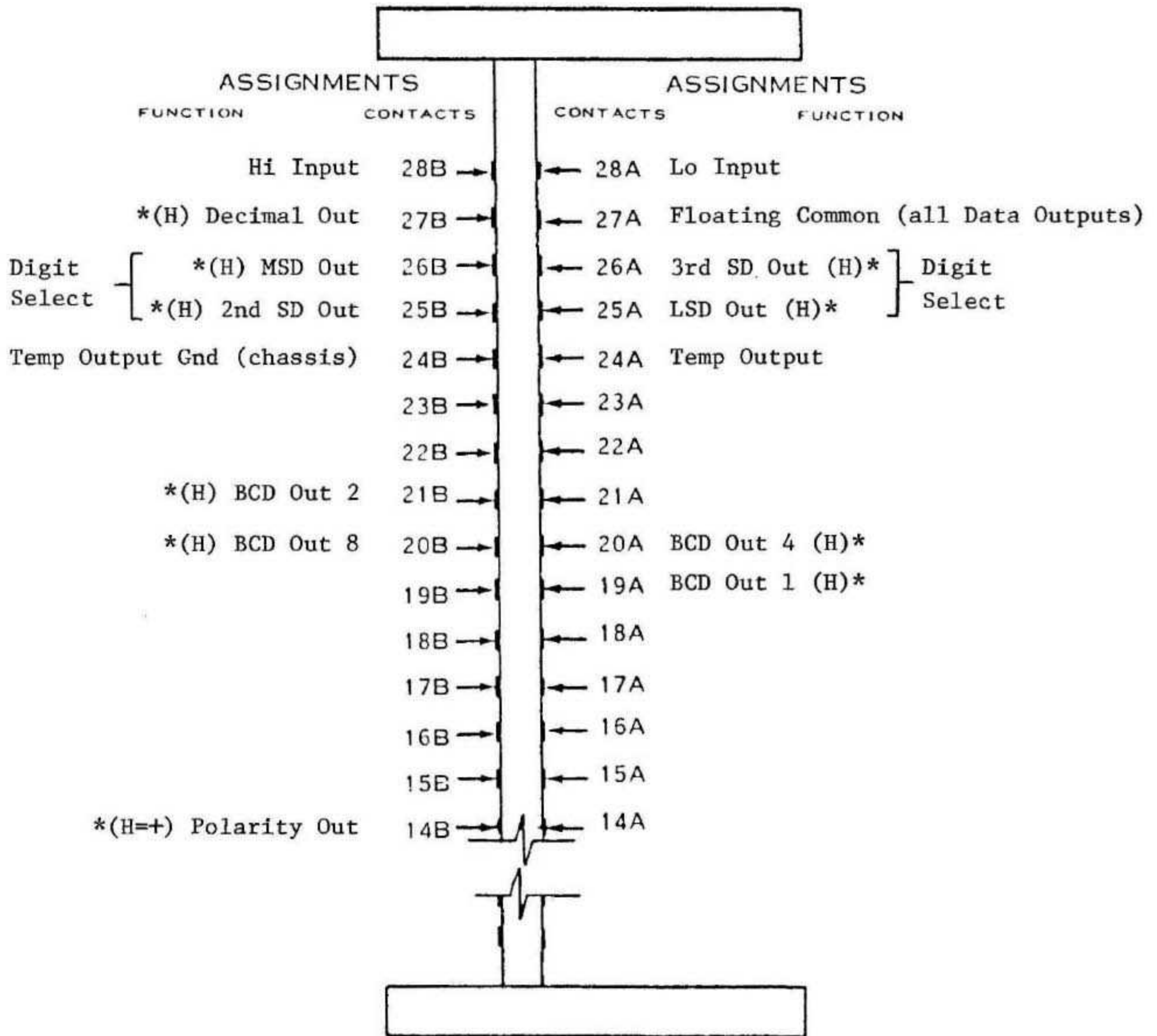

\*Optional - see Interface Notes. These outputs must be buffered before using them to drive external inputs. Letter in ( ) indicates active level.

### CAUTION

*When a Power Module compartment has been selected for the DM 502 and wired for a specialized interface system, a plastic barrier (Tektronix Part Number 214-1593-02) should be installed in the key slot between contacts 17 and 18 on the Power Module.*

*Do not insert any TM 500 Series plug-in in a live Power Module and do not use excessive force when inserting the plug-in.*



## INTERFACE NOTES

### General

The HI Input (contact 28B), LO Input (contact 28A), Temp Output (contact 24A), and Temp Output Gnd (contact 24B - chassis ground) are the only DM 502 input/output functions that are factory wired to the rear-interface contacts. If it is desired to transmit digital data through the power module interface the connections to the rear-interface contacts must be user wired. Suggested instructions for obtaining digital data from the DM 502 is included in these Interface Notes.

### HI Input and LO Input (Contacts 28B and 28A)

Measurement signals, except temperature (TEMP PROBE), can be applied directly through the rear interface HI (28B) and LO (28A) circuit board contacts. Comparisons can be made between front panel and rear interface measurement sources by using the EXT-INT pushbutton switch on the front panel of the DM 502.

When using the rear interface HI and LO contacts, the maximum deviation from earth ground (dc plus peak ac) should not exceed 350 volts, or +50 dBm in the dB mode. The impedance between the HI and LO contacts is dependent on the position of the front-panel range/function switch (type of measurement being made). For further details related to input impedance and input limitations refer to the Electrical Specifications section of the DM 502 instruction manual.

### Temp Output and Temp Output Gnd (Contacts 24A and 24B)

These contacts can be used to monitor a dc voltage proportional to temperature measurements when using a P6430 probe connected to the front-panel TEMP PROBE input connector. The output impedance at contact 24A is quite low and a 10,000 to 20,000  $\Omega/V$  meter can be driven directly from this point. Sensitivity (for a properly calibrated system) is 10 mV/ $^{\circ}C$  or 10 mV/ $^{\circ}F$ . In normal operation  $^{\circ}C$  or  $^{\circ}F$  mode is selected by a front-panel switch and the dc voltage measured on contact 24A (2 volts maximum) is directly related to the temperature value displayed on the DM 502 front panel.

If it is desired to monitor the dc voltage (at 24A) related to temperature while using the front-panel range/function control to perform other measurement functions, the user can modify the internal circuitry in the following manner (refer to Fig. 1):

1. For monitoring in the  $^{\circ}\text{C}$  mode, disconnect either end of R285.
2. For monitoring in the  $^{\circ}\text{F}$  mode, connect a jumper wire between the center terminal of potentiometer R268 ( $^{\circ}\text{F}$ ) and the solder pad as shown.

The DM 502 Option 2 instrument does not have the temperature measurement or monitoring capability and contact 24A for an Option 2 instrument is grounded to the chassis.

### Digital Data Output (Optional Contacts)

The DM 502 front-panel readout is a  $3\frac{1}{2}$  digit display using four seven-segment LEDs. The most significant digit (MSD) is at the extreme left with the least significant digit (LSD) at the extreme right of the display. The digits are numbered 1, 2, 3, 4 (from right to left) with the LSD being digit 1 and the MSD being digit 4.

The internal circuitry for the DM 502 does not scan the digits in a 1, 2, 3, 4 sequence. The scan sequence is digit 1 (LSD), digit 3, digit 2, and then digit 4 (MSD) for one complete scan of all the digits.

In order to obtain digital data through the rear interface, the optional contacts must be user wired to specific data points on the DM 502 circuit board. Refer to Fig. 2 for the specific data point locations and the solder pad connections for the rear-interface contacts.

#### CAUTION

*All digital data outputs and the LO input terminals (front and rear) of the DM 502 is referenced to a floating common (contact 27A) when wired according to Fig. 2. If the data outputs are wired to a peripheral instrument with a chassis ground reference, the DM 502 circuitry must also be referenced to chassis ground. If the DM 502 circuitry is left floating as little as 0.2 volts away from chassis ground, the result is a possible loss of data and just a few volts more than this can result in damage to the DM 502 and the peripheral instrument. The DM 502 floating common can be referenced to chassis ground by connecting a jumper between the LO and chassis ground terminals on the front panel.*

If the DM 502 is user wired according to Fig. 2 the digital data outputs (signal lines) must be buffered to prevent excessive loading on the DM 502 data lines. A typical transistor buffer circuit is also illustrated in Fig. 2. Note that the digit scan sequence (1 - 3 - 2 - 4) remains the same as the front panel scan sequence. When using the transistor type of buffer circuit the BCD and Digit Select output logic level format is changed from active high true to active



## Digital Meters—DM 502

low true. The output logic level format for the Transfer signal line (contact 19B) is true in the low state and this signal line might require a buffer circuit of opposite polarity than the circuit suggested in Fig. 2. It is suggested that the transistor buffer circuits drive additional inverter circuits to retain the same logic level format as the DM 502.

It is not recommended that TTL devices be connected directly to the digital data lines at the rear interface. As a result, external interface alternatives should include low current load devices such as CMOS, or the isolation circuitry similar to that shown in Fig. 3.

### NOTE

*When any DM 502 interface system has been completed, it might be necessary to perform Step 3 of the Internal Adjustment Procedure in order to Adjust Integrator Zero. Refer to the DM 502 instruction manual.*

The isolation circuitry shown in Fig. 3 performs two major functions. It allows digital data to be transmitted through the rear interface when the DM 502 is floated above ground (chassis) reference, within specified limitations, and changes the digit scan sequence from 1 - 3 - 2 - 4 to a 1 - 2 - 3 - 4 sequence. This circuit could be built on an auxiliary board mounted on the cam switch. If this is done, connect the specific data points to the input of the isolators and the output terminals to the designated rear-interface contacts. The output signal lines are TTL compatible. All of the IC's should be CMOS devices so that the outputs of the isolators are not loaded. The circuit requires two quad-nand-gates, one hex-inverter, one J-K flip-flop, four CA3083 transistor packages and ten optical isolators. When connecting the CA3083 transistors be certain that the transistor packages are not mixed between the isolator and driver circuits and that the substrate for each package is tied to its individual signal ground reference.

A time-ladder diagram for the circuit illustrated in Fig. 3 is shown in Fig. 4. Note that the DM 502 Digit Select pulses are approximately 0.4 ms duration with the DM 502 scan period (1 - 3 - 2 - 4 sequence) being approximately 1.56 ms. The J-K flip-flop changes the digit scan sequence by enabling one pair of the nand gates for digits 1 and 2 for one DM 502 scan period and then enabling the other pair of nand gates for digits 3 and 4 during the next DM 502 scan period. The J-K flip-flop is clocked by the negative-going edge of the MSD pulse. As a result, the complete period for the 1 - 2 - 3 - 4 digit select sequence is increased to about 3.12 ms.

The DM 502 internal circuitry has the ability to count to approximately 3100 even though the numeral for digit 4 (MSD) on the front panel is limited to the numeral 1. The DM 502 front-panel display starts blinking at the count of 2000 and the numeral 2 or 3 will not appear on the DM 502 display. By applying a logic low level to the two nand gates for binary bits 4 and 8 during the MSD time slot, the interface circuitry has the ability to provide valid counts up to 3000 even though the display may be blinking.

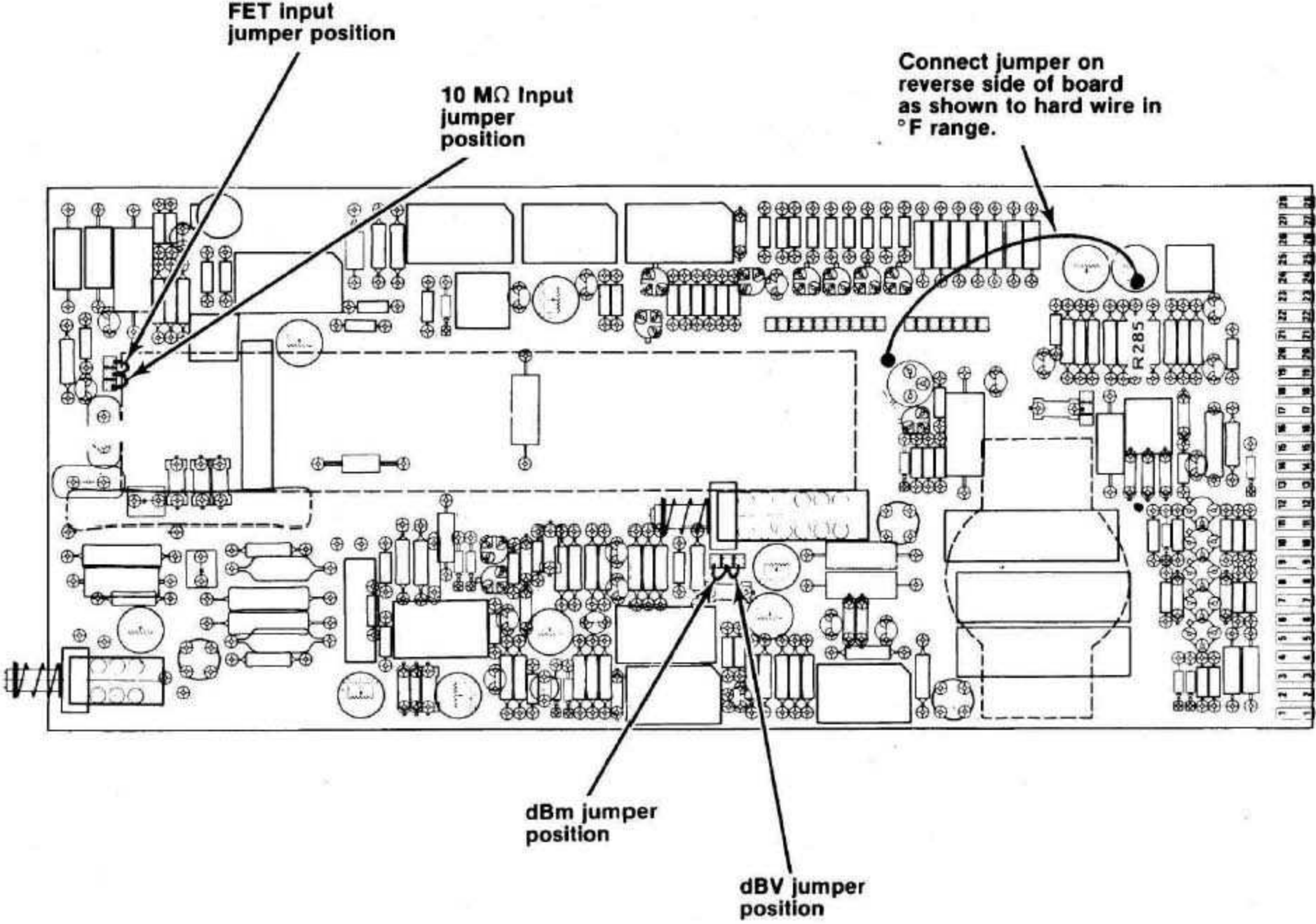

FIG. 1



LOCATIONS FOR USER WIRED REAR INTERFACE CONNECTIONS

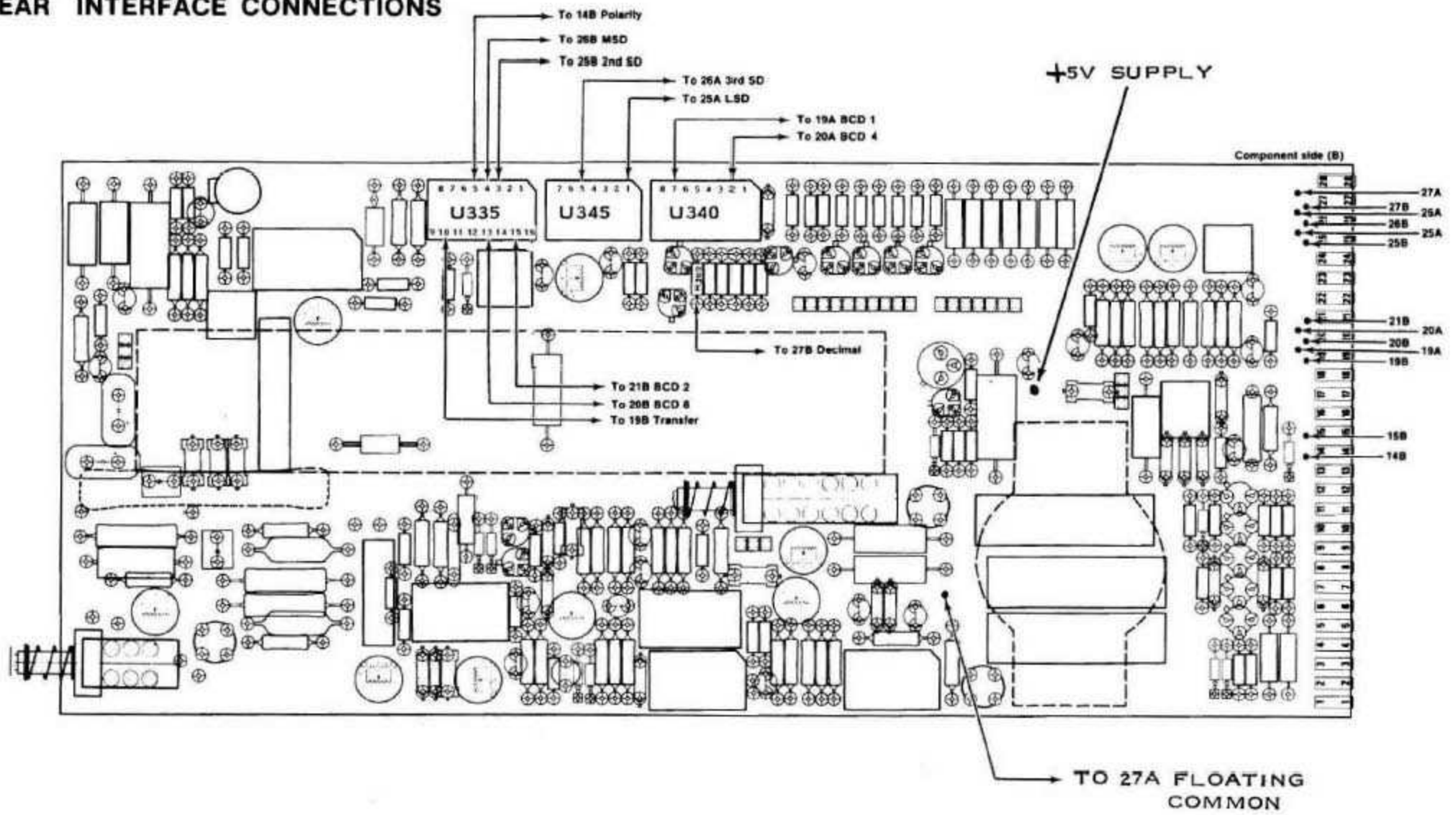
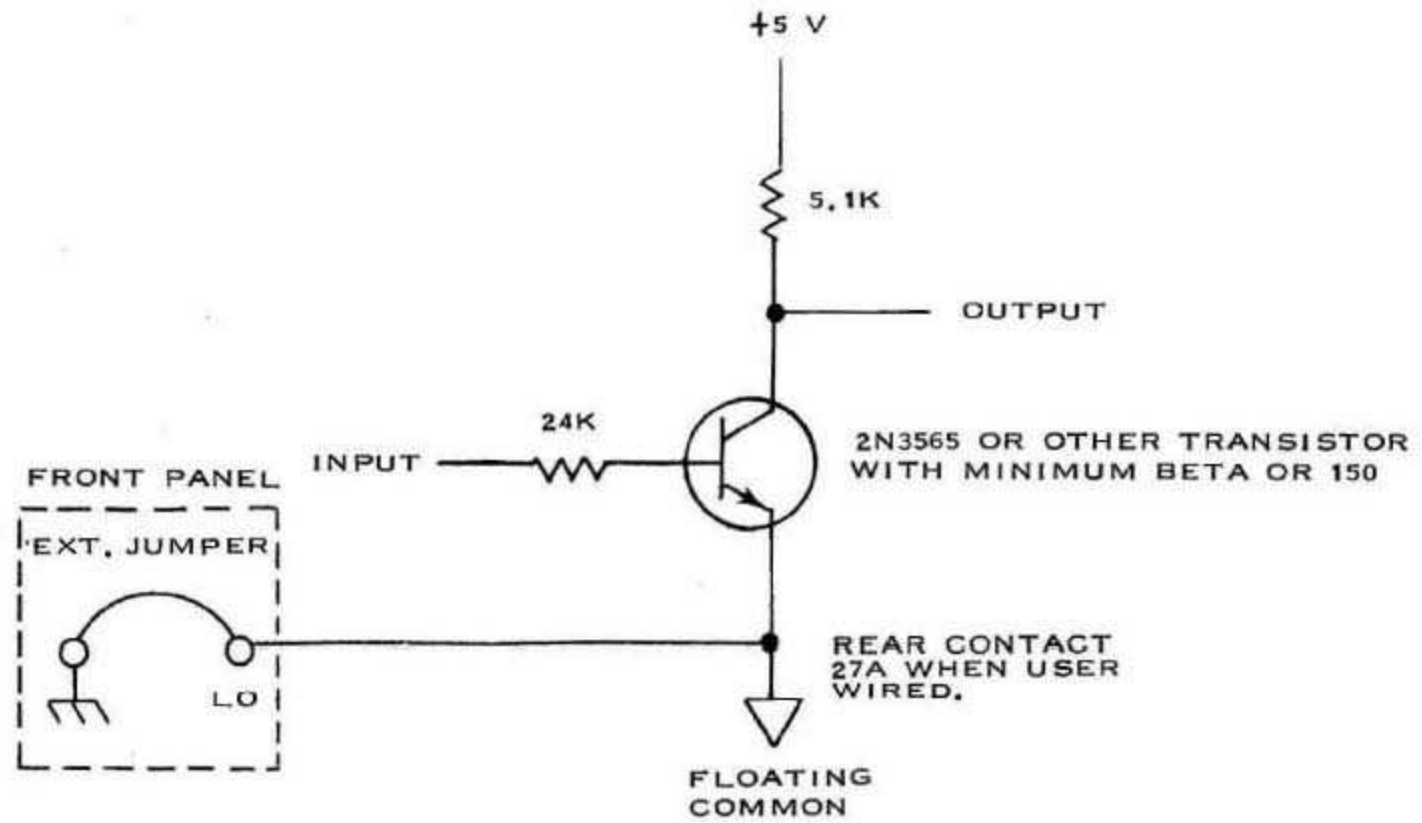

FIG. 2



TYPICAL BUFFER CIRCUIT FOR REAR CONNECTOR DATA OUTPUTS.  
UP TO 20MA MAY BE USED FORM THE DM 502 +5 V SUPPLY.

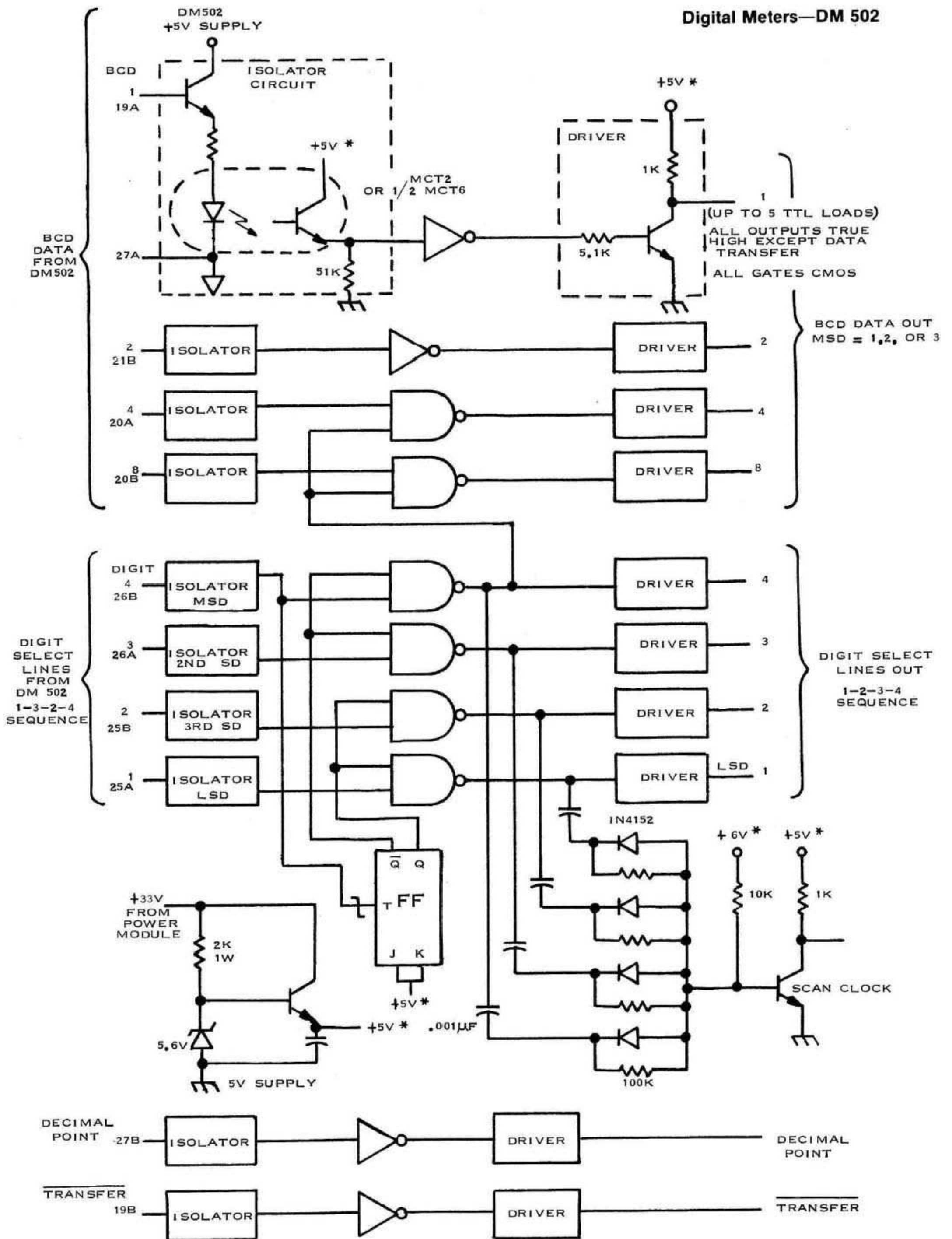

FIG. 3

Digital Meters—DM 502

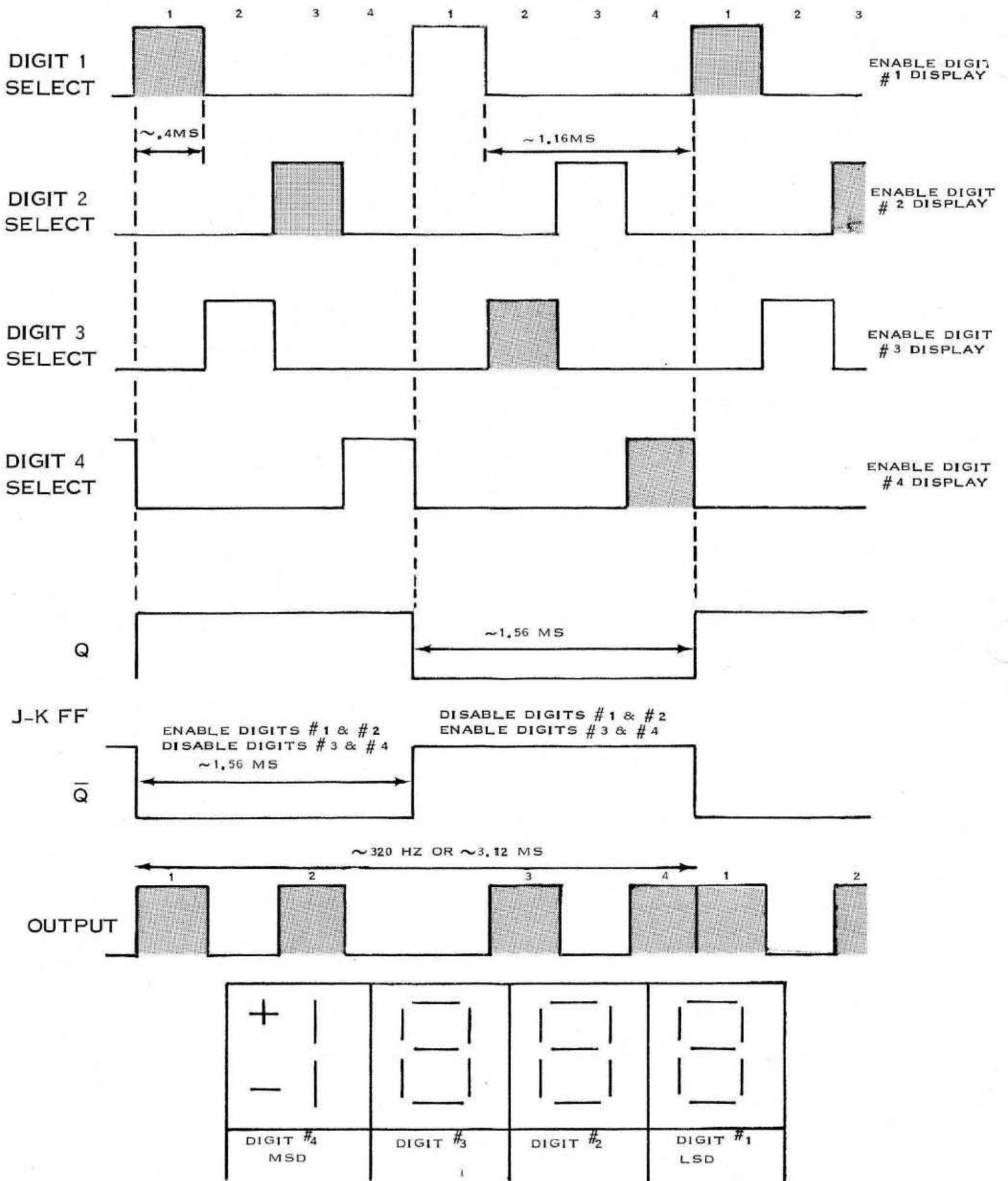

FIG. 4

# **SECTION 9**

## **FUNCTION GENERATORS**





## Plug-In or Power Module Rear View

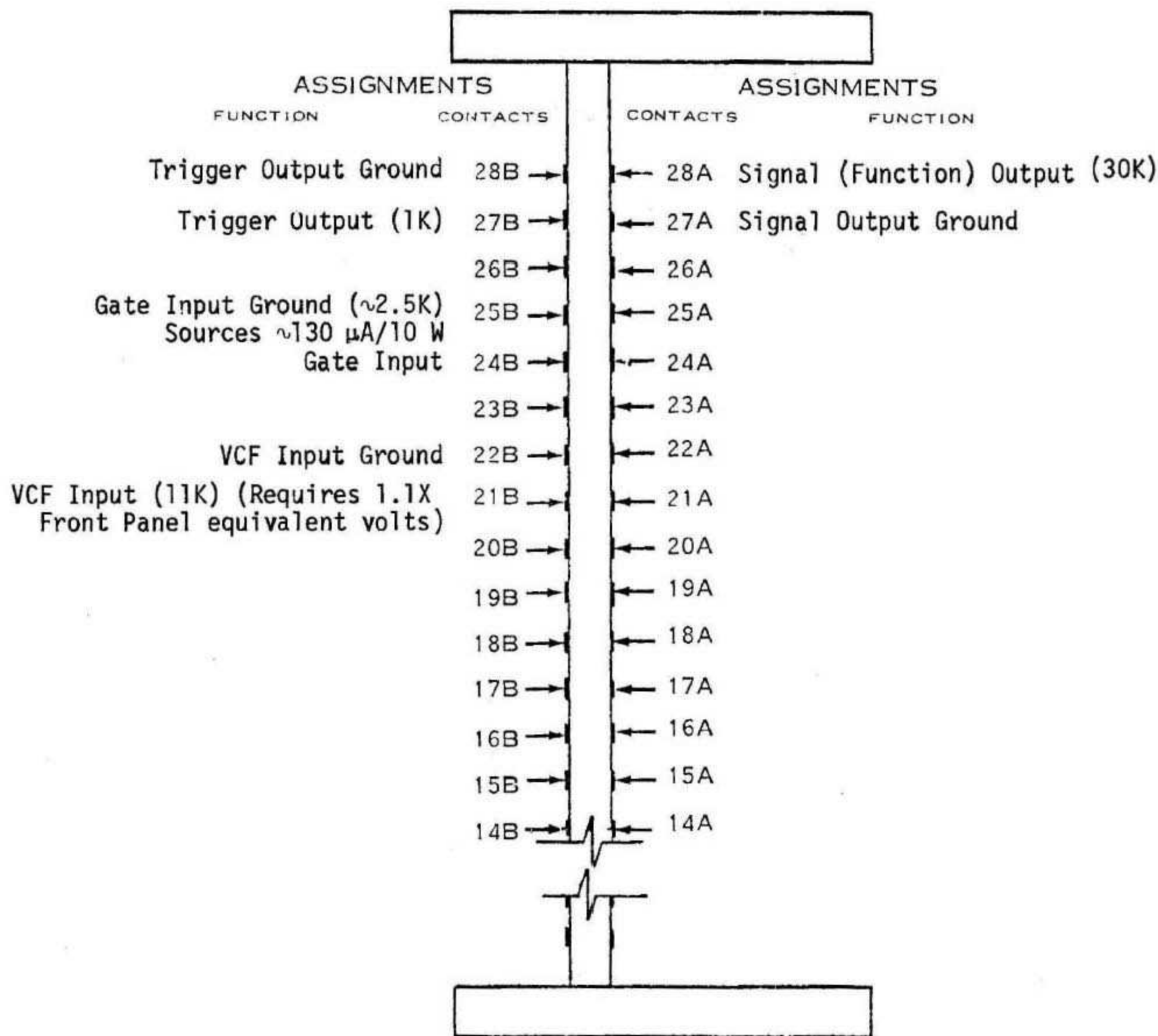

### CAUTION

When a Power Module compartment has been selected for the FG 501 and wired for a specialized interface system, a plastic barrier (Tektronix Part Number 214-1593-02) should be installed in a key slot between contacts 23 and 24 on the Power Module.

Do not insert any TM 500 Series plug-in in a live Power Module and do not use excessive force when inserting the plug-in.

## INTERFACE NOTES

### General

In order to maintain waveform fidelity all input/output connections to the Power Module interface should be done using coaxial cable, paying particular attention to cable layout to reduce cross talk to a minimum.

### Signal (Function) Output (Contacts 28A and 27A)

All waveforms (including dc offset) available at the front-panel OUTPUT connector are transmitted to the rear interface via contact 28A. Source impedance from 28A is nominally 30 k $\Omega$  (to provide external equipment isolation). Normal load impedance should be 300 k $\Omega$ , or greater. To convert contact 28A to a low impedance source, R299 can be replaced with a 47 ohm, 1 watt resistor. When this is done, the use of the front-panel OUTPUT connector and contact 28A at the same time can cause some waveform distortion. The absolute signal amplitude across the load is dependent on the voltage divider ratio of the FG 501 source and load impedance. Open-circuit output amplitudes are 15 V peak-to-peak with  $\pm$  5 V dc offset. In some cases, high-frequency compensation may be necessary. Ground coaxial-cable shield to contact 27A.

### Trigger Output (Contacts 27B and 28B)

Trigger signals from rear contact 27B are derived from a 1 k $\Omega$  source impedance with the absolute output amplitude being load dependent. Open-circuit output amplitude is about 5 V peak-to-peak. The trigger waveform is rectangular; the period and duty cycle is dependent upon the selected frequency and type of waveform selected by the FUNCTION switch. The trigger signal is the best output to drive a counter, because its waveshape and amplitude does not change with front-panel control settings. Use contact 28B to ground a coaxial-cable shield.

### Gate Input (Contacts 24B and 25B)

The Gate Input signal to contact 24B should be at least + 2 V and not more than +15 V. Refer to FG 501 Instruction Manual for operation and applications related to Gated (Burst) Output, Variable Phase, Tone-Burst Generation or Stepped-Frequency Multiplication. Use contact 25B to ground a coaxial-cable shield. Input impedance for contact 24B is about 2 k $\Omega$ .

VCF Input (Contacts 21B and 22B)

An input signal (0 V to + 11 V maximum - usually a linear ramp) applied to contact 21B can be used to operate the FG 501 in a Voltage-Controlled Frequency mode. Refer to FG 501 Instruction Manual. A positive-going signal sweeps the selected frequency upwards, while a negative-going signal sweeps the selected frequency downwards. Input impedance for contact 21B is about 11 k $\Omega$ . Use contact 22B to ground a coaxial-cable shield.





## Plug-In or Power Module Rear View

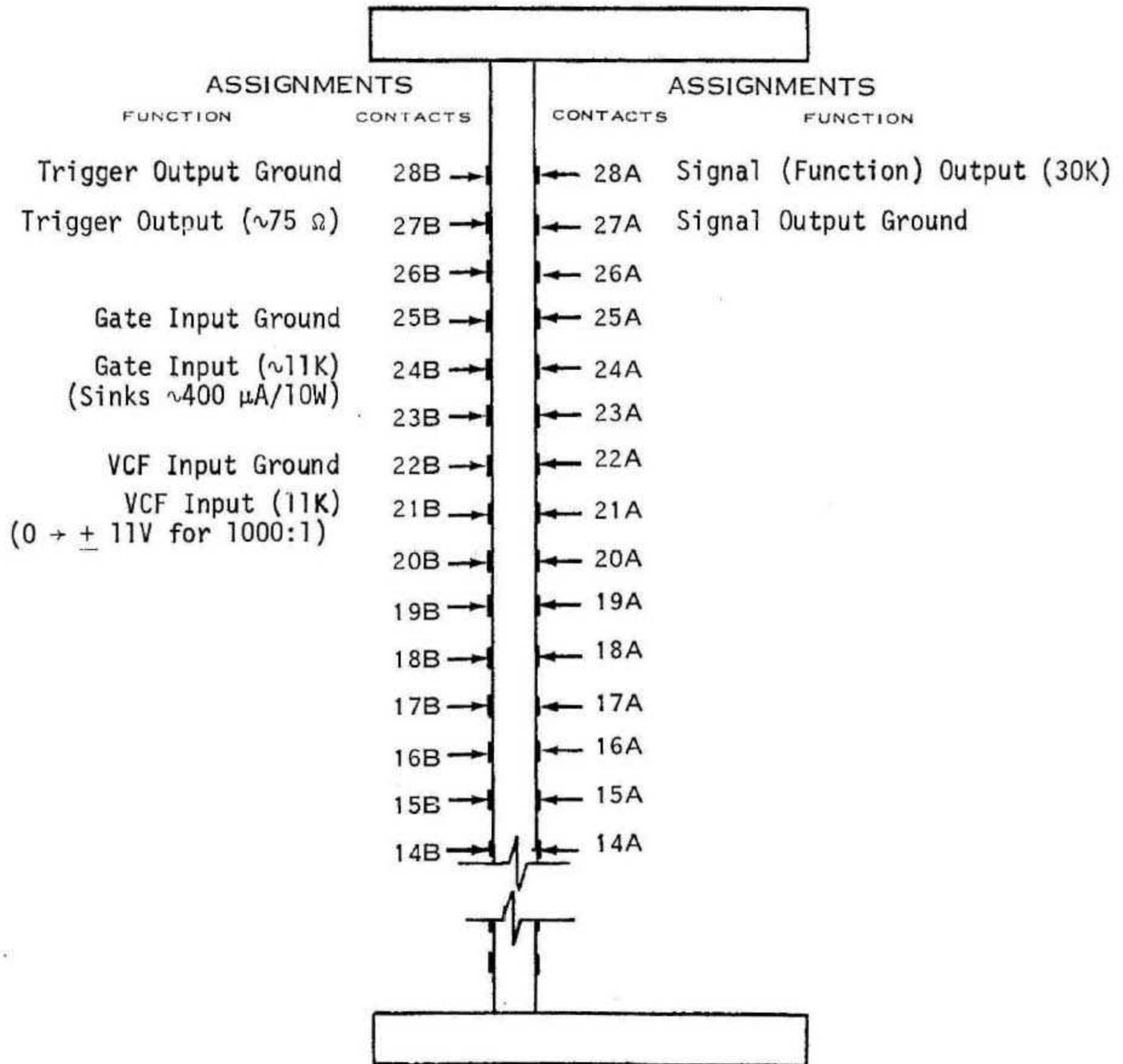

## CAUTION

When a Power Module compartment has been selected for the FG 502 and wired for a specialized interface system, a plastic barrier (Tektronix Part Number 214-1593-02) should be installed in a key slot between contacts 23 and 24 on the Power Module.

Do not insert any TM 500 Series plug-in in a live Power Module and do not use excessive force when inserting the plug-in.

## INTERFACE NOTES

### General

In order to maintain waveform fidelity all input/output connections to the Power Module interface should be done using coaxial cable, paying particular attention to cable layout to reduce cross talk to a minimum.

### Signal (Function) Output (Contacts 28A and 27A)

All waveforms (including dc offset) available at the front-panel OUTPUT connector are transmitted to the rear interface via contact 28A. Source impedance from 28A is nominally 30 k $\Omega$ , (to provide external equipment isolation). Normal load impedance should be 300 k $\Omega$ , or greater. To convert contact 28A to a low impedance source, R560 can be replaced with a 47-ohm, 1 watt resistor. When this is done, the use of the front-panel OUTPUT connector and contact 28A at the same time can cause some waveform distortion. The absolute signal amplitude across the load is dependent on the voltage divider ratio of the FG 502 source and load impedances. Open-circuit output amplitudes are 10 V peak-to-peak with +5 V dc offset. In some cases, high-frequency compensation may be necessary. Ground coaxial-cable shield to contact 27A.

### Trigger Output (Contacts 27B and 28B)

Trigger signals from rear contact 27B are derived from a  $\approx 75 \Omega$  source impedance with the absolute output amplitude being load dependent. Open-circuit output amplitude is about 5 V peak-to-peak. The trigger waveform is rectangular; the period and duty cycle is dependent upon the selected frequency and type of waveform selected by the FUNCTION switch. The trigger signal is the best output to drive a counter or edge-triggered devices, because its waveshape and amplitude does not change with front-panel control settings. Use contact 28B to ground a coaxial-cable shield.

### Gate Input (Contacts 24B and 25B)

The Gate Input signal to contact 24B should be 0 V to +2 V or greater and not to exceed +15 V. Refer to FG 502 Instruction Manual for operation and applications related to Gated Output, Tone-Burst Generation or Stepped-Frequency Multiplication. Use contact 25B to ground a coaxial-cable shield. Input impedance for contact 24B is about 11 k $\Omega$ .

VCF Input (Contacts 21 B and 22B)

An input signal (0V to +11 V maximum - usually a linear ramp) applied to contact 21B can be used to operate the FG 502 in a Voltage-Controlled Frequency mode. Refer to FG 502 Instruction Manual. A positive-going signal sweeps the selected frequency upwards, while a negative-going signal sweeps the selected frequency downwards. Input impedance for contact 21B is about 11 k $\Omega$ . Use contact 22B to ground a coaxial-cable shield.





## Plug-In or Power Module Rear View

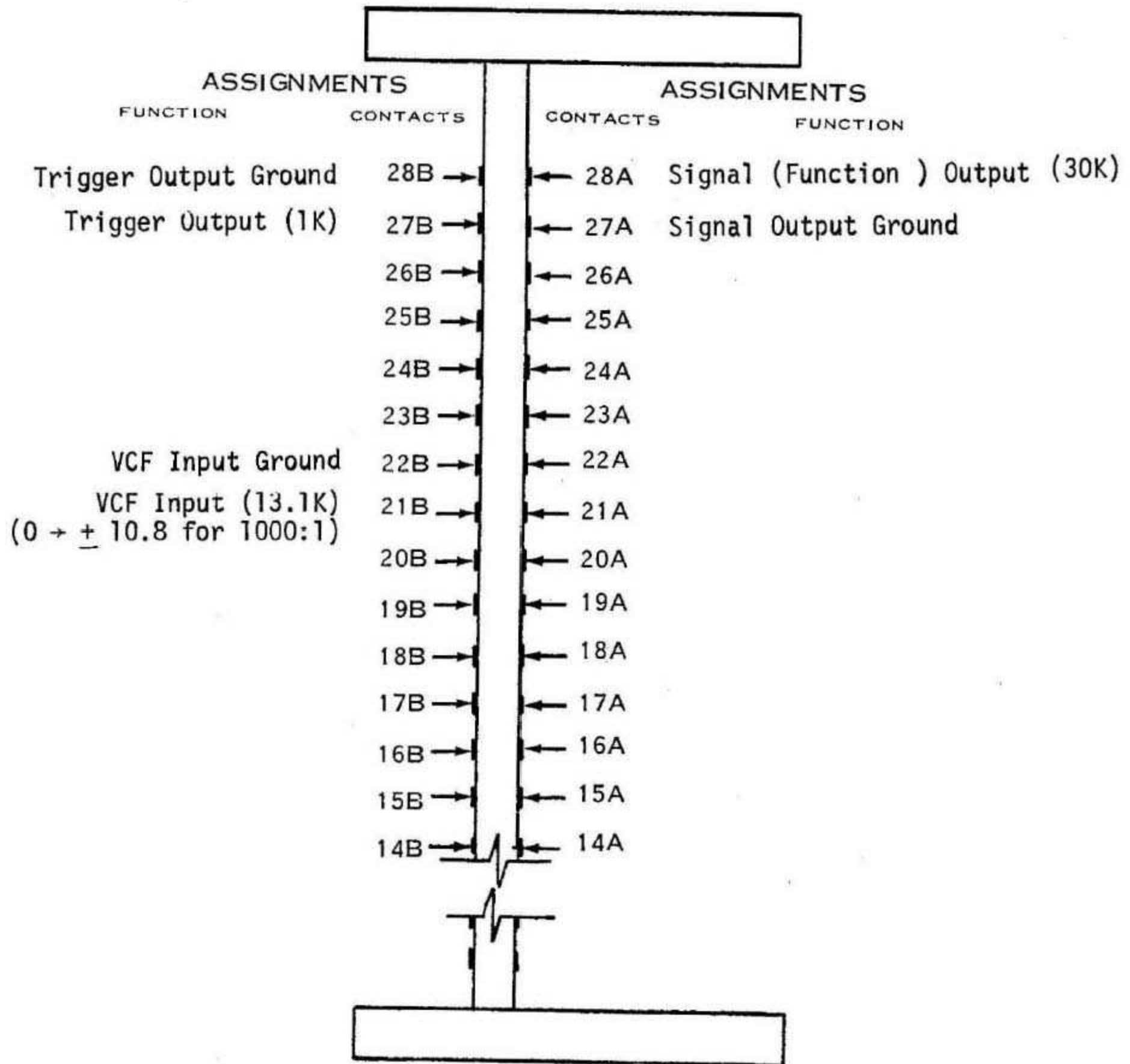

**CAUTION**

When a Power Module compartment has been selected for the FG 503 and wired for a specialized interface system, a plastic barrier (Tektronix Part Number 214-1593-02) should be installed in a key slot between contacts 23 and 24 on the Power Module.

Do not insert any TM 500 Series plug-in in a live Power Module and do not use excessive force when inserting the plug-in.

## INTERFACE NOTES

### General

In order to maintain waveform fidelity all input/output connections to the Power Module interface should be done using coaxial cable, paying particular attention to cable layout to reduce cross talk to a minimum.

### Signal (Function) Output (Contacts 28A and 27A)

All waveforms (including dc offset) available at the front-panel OUTPUT connector are transmitted to the rear interface via contact 28A. Source impedance from 28A is nominally 30 k $\Omega$  (to provide external equipment isolation). Normal load impedance should be 300 k $\Omega$ , or greater. If it is desired to convert contact 28A to a low impedance source, R412 can be replaced with a 47-ohm, 1 watt resistor. When this is done, the use of the front-panel OUTPUT connector and contact 28A at the same time can cause some waveform distortion. The absolute signal amplitude across the load is dependent on the voltage divider ratio of the FG 503 source and load impedances. Open-circuit output amplitudes are 20 V peak-to-peak with +5 V dc offset. In some cases, high-frequency compensation may be necessary. Ground coaxial-cable shield to contact 27A.

### Trigger Output (Contacts 27B and 28B)

Trigger signals from rear contact 27B are derived from a 1 k $\Omega$  source impedance with the absolute output amplitude being load dependent. Open-circuit output amplitude is about 5 V peak-to-peak. The trigger waveform is rectangular with the period and duty cycle dependent upon the selected frequency and type of waveform selected by the FUNCTION switch. The trigger signal should be used to drive a counter or edge-triggered devices, because its waveshape and amplitude does not change with front-panel control settings. Use contact 28B to ground a coaxial-cable shield.

### VCF Input (Contacts 21B and 22B)

An input signal (0V to + 10.8 V maximum - usually a linear ramp) applied to contact 21B can be used to operate the FG 503 in a Voltage-Controlled Frequency mode. Refer to FG 503 Instruction Manual. A positive-going signal sweeps the selected frequency upwards, while a negative-going signal sweeps the selected frequency downwards. Input impedance for contact 21B is about 13.1 K. Use contact 22B to ground a coaxial-cable shield.

## Plug-In or Power Module Rear View

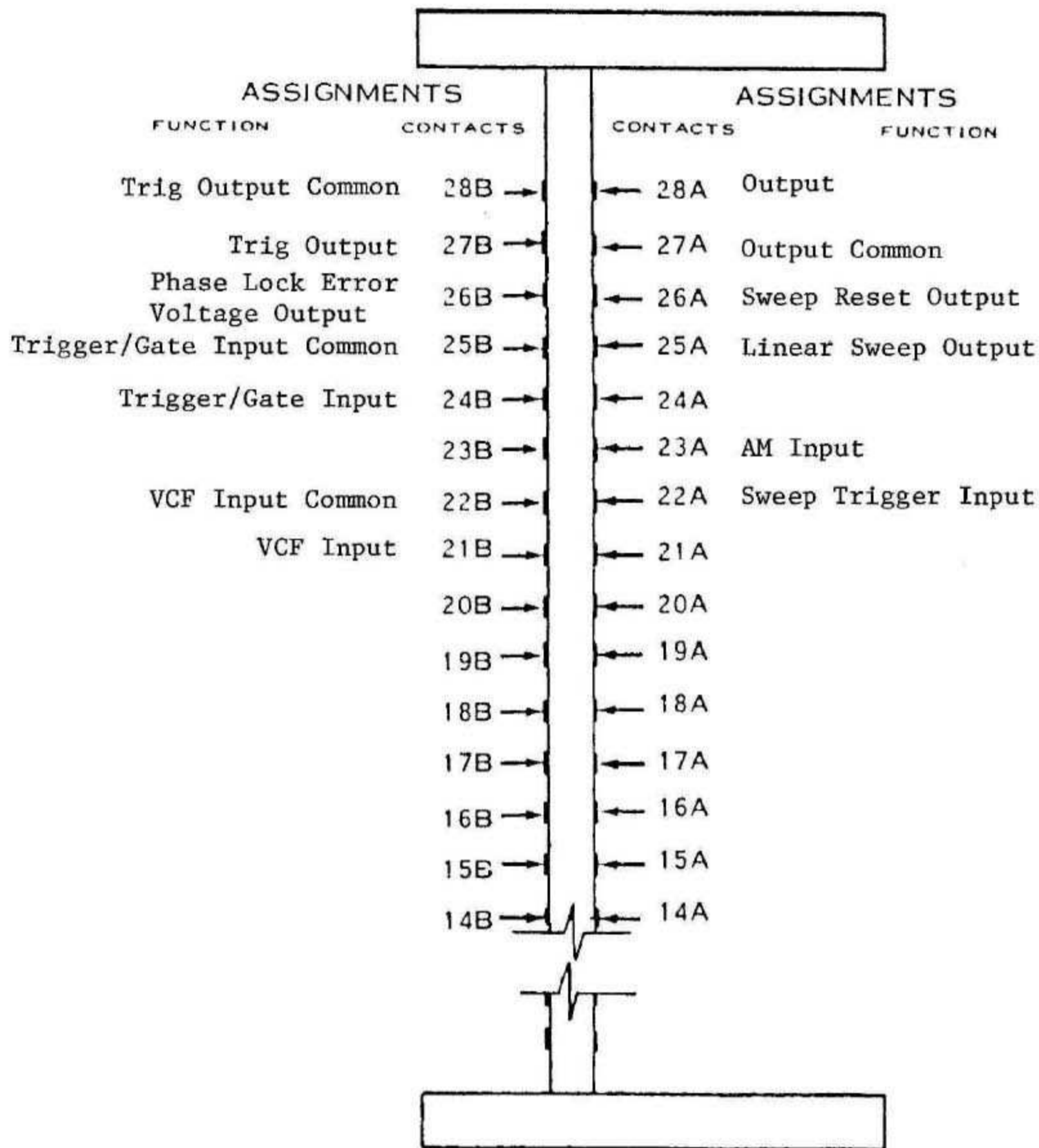

Pins 14 through 28 are not used on the Main board. All connections shown for pins 21 through 28 are on the Floating board.

### CAUTION

*When a Power Module compartment has been selected for the FG 504 and wired for a specialized interface system, a plastic barrier (Tektronix Part Number 214-1593-02) should be installed in the key slot between contacts 23 and 24 on the Power Module.*

*Do not insert any TM 500 Series plug-in in a live Power Module and do not use excessive force when inserting the plug-in.*



## INTERFACE NOTES

### Output (Pin 28A)

This terminal is connected to the front panel OUTPUT connector through a 30 k $\Omega$  resistor. The common terminal for this output is pin 27A.

### Sweep Reset Output (Pin 26A)

A positive-going pulse from about -13 V to about +9 V occurs at this connection at the time the sweep resets. This output is designed to drive at least 10 k $\Omega$ . The pulse can be used to raise the pen on a chart recorder when doing sweep frequency tests on filters or other devices or as end-of-sweep trigger for an external device. Connect the return line to chassis ground.

### Linear Sweep Output (Pin 25A)

This terminal is connected to the output of the sweep generator through a 1 k $\Omega$  resistor. The waveform at this terminal is identical with the waveform at the front panel LIN SWEEP OUTPUT terminal except in the STOP FREQ mode. In the STOP FREQ mode this rear connection continues to output the linear sweep ramp while the front panel connection outputs a dc voltage equivalent to the peak ramp voltage. To make the output at the rear terminal the same as the LIN SWEEP OUTPUT terminal, remove the lower end of R1525 from the Function board. Connect an eight inch wire from the lower end of R1525 to the lower end of R1520 also located on the Function board. The exact location of these resistors can be found from the Parts Location Grid. Use chassis ground as the return circuit.

### AM Input (Pin 23A)

This input has the same input characteristics as the AM INPUT connection on the front panel. Use chassis ground for the circuit return.

### Sweep Trigger Input (Pin 22A)

This terminal is connected to the front panel SWP TRIG INPUT connector through a 1.5 k $\Omega$  resistor. Use chassis ground for the return circuit.

### Trigger Output (Pin 27B)

This connection is made through a 510  $\Omega$  resistor to the front panel TRIG OUTPUT connector. Use connection 27B for the return circuit.

### Phase Lock Error Voltage Output (Pin 26B)

The signal at this terminal is the output of the phase locked loop filter. An output of 0 V indicates the reference frequency is the same as the free-run frequency. A voltage of +10 V open circuit indicates a generator output frequency of about 10 dial divisions higher than the free run frequency and -10 V open circuit indicates a generator frequency about 10 dial divisions lower than the free-run frequency. The output impedance is 1 k $\Omega$ . Use the chassis ground as the return circuit.

### Trigger/Gate Input (Pin 24B)

This connection has the same dc input characteristics as the front panel TRIGGER INPUT connector. Use the chassis as the return circuit.

### VCF Input (Pin 21B)

This connection has the same input characteristics as the front panel VCF INPUT connector. Use contact 22B as the return circuit.

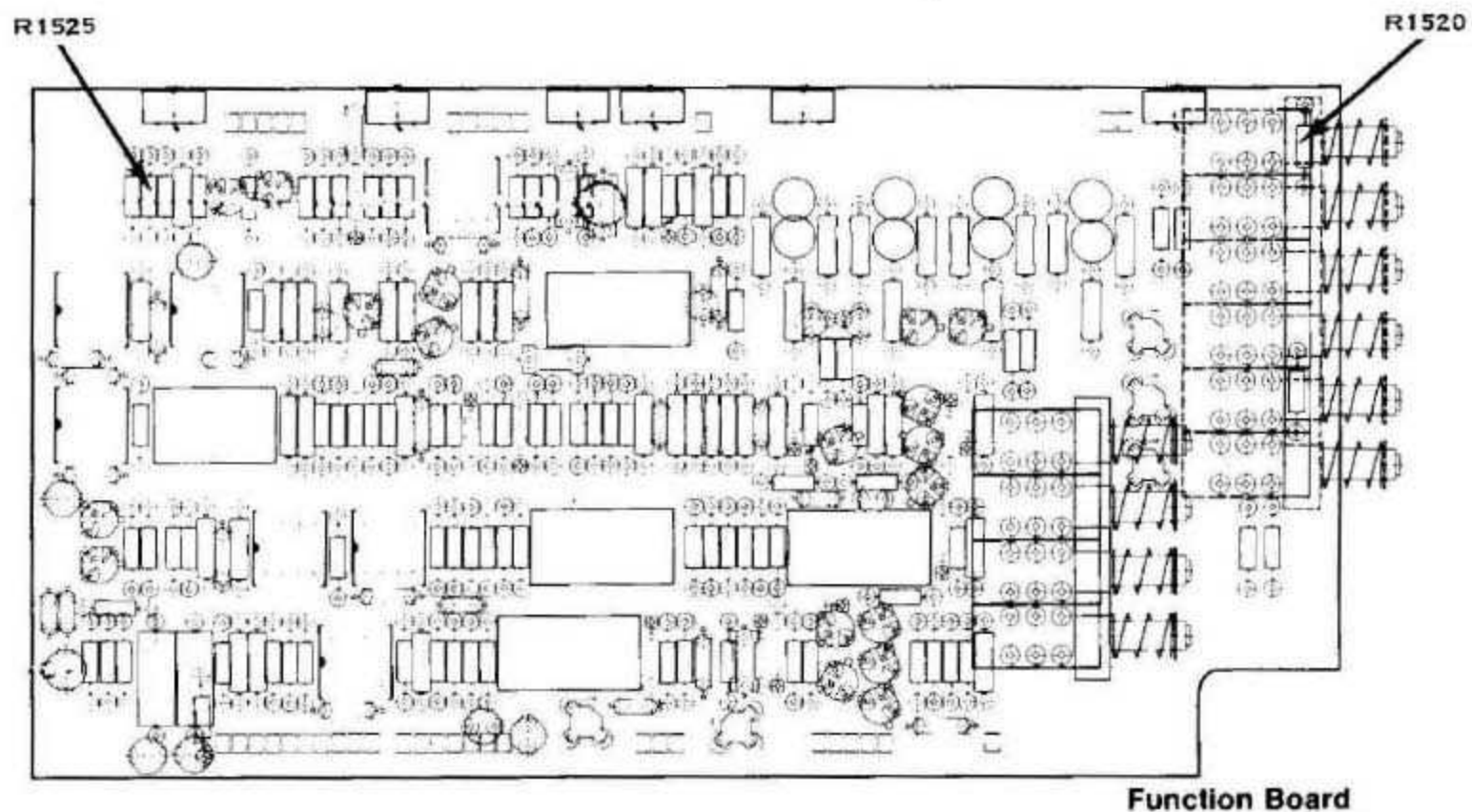

# **SECTION 10**

## **LOGIC ANALYZERS**





## Plug-In or Power Module Rear View

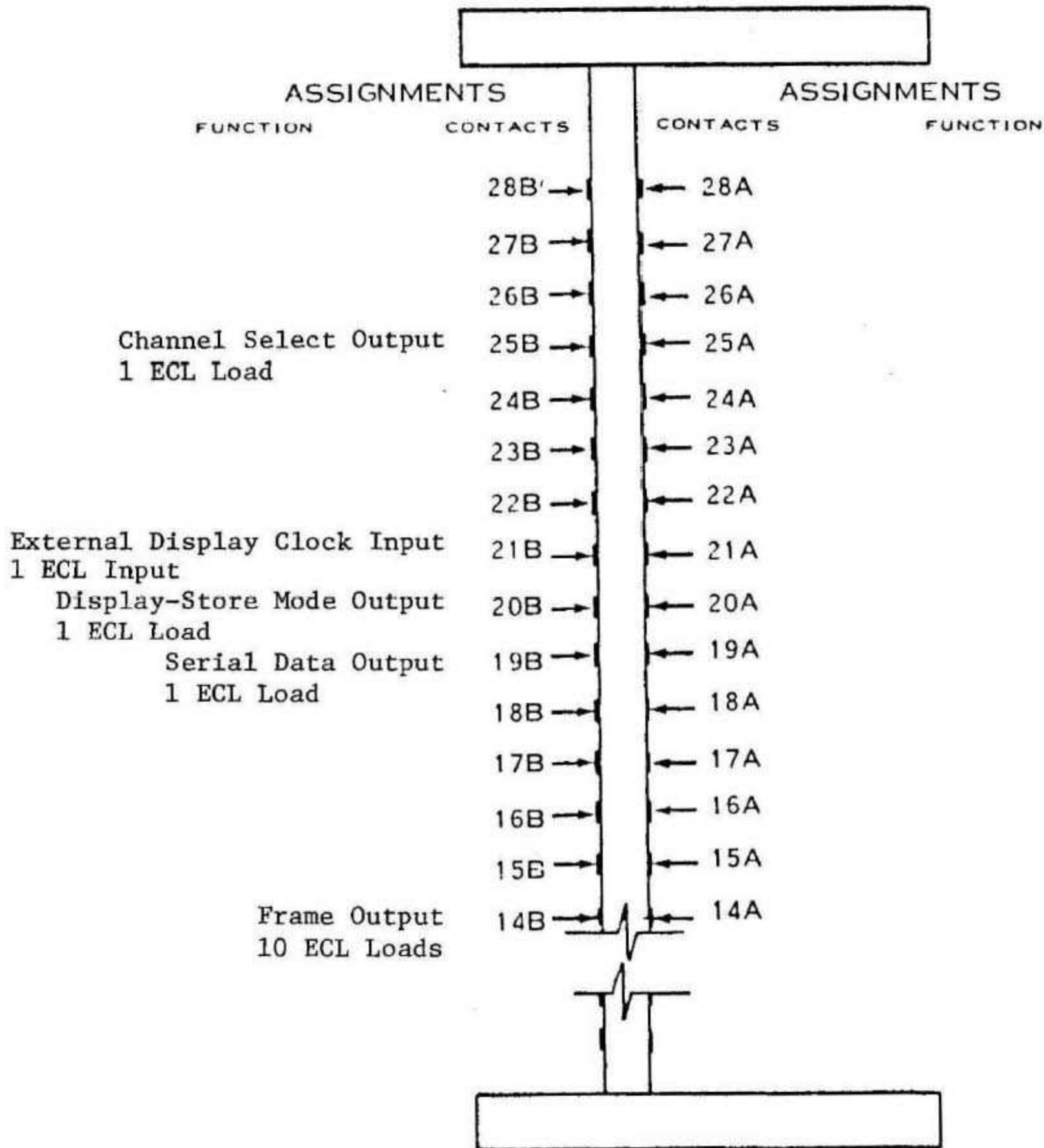

These assignments are for instruments with serial numbers of B010250 and up.

### CAUTION

*When a Power Module compartment has been selected for the LA 501 and wired for a specialized interface system, a plastic barrier (Tektronix Part No. 214-1593-02) should be installed in a key slot between contacts 24 and 25 on the Power Module.*

*Do not insert any TM 500 Series plug-in in a live Power Module and do not use excessive force when inserting the plug-in.*

## INTERFACE NOTES

### General

To maintain waveform fidelity, make connections to the power module interface with coaxial cable. Carefully place the cable to keep cross talk to a minimum.

### Frame Output (14B)

The output at contact 14B represents the scanning status of the serial data output. Channel 3 is the last channel scanned in the serial data output. The output is an ECL low pulse, which occurs once each 16 flag pulses (or every 4096 bits of data serially scanned -- see J120-14 for flag output). The leading edge of the low pulse is the start of a channel 3 serial scan and the trailing edge is the end of the channel 3 scan.

### Serial Data Output (19B)

Contact 19B is the output of the memory which has been converted from parallel data to serial data form (negative-voltage ECL). See Table 1 for channel output sequence.

### Display-Store Mode Output (20B)

This output contact 20B indicates the status of the display-store mode. The output is negative-voltage ECL. In the display mode, the output level is low and in the store mode it is high. (The output is actually the internal display clock inhibit signal).

### Ext Display Clock Input (21B)

Contact 21B is an external input used as a display clock in the display mode. Using this input involves internal switch (S835) selection. This input accepts negative-voltage ECL.

### Channel Select Output (25B)

The output at contact 25B indicates the scanning status of a channel that has been selected for positioning. The output is negative-voltage ECL. This line provides a low pulse each time a channel selected for

positioning is scanned in serial data format. When the next channel is selected for scanning, the output returns high.

Table 1

Serial Data Output Sequence

FORMAT		
4 CH	8 CH	16 CH
CHANNEL DISPLAYED		
0	4	12
1	5	13
2	6	14
3	7	15
0	0	8
1	1	9
2	2	10
3	3	11
0	4	4
1	5	5
2	6	6
3	7	7
0	0	0
1	1	1
2	2	2
3	3	3

# **SECTION 11**

## **MONITORS**





## Plug-In or Power Module Rear View

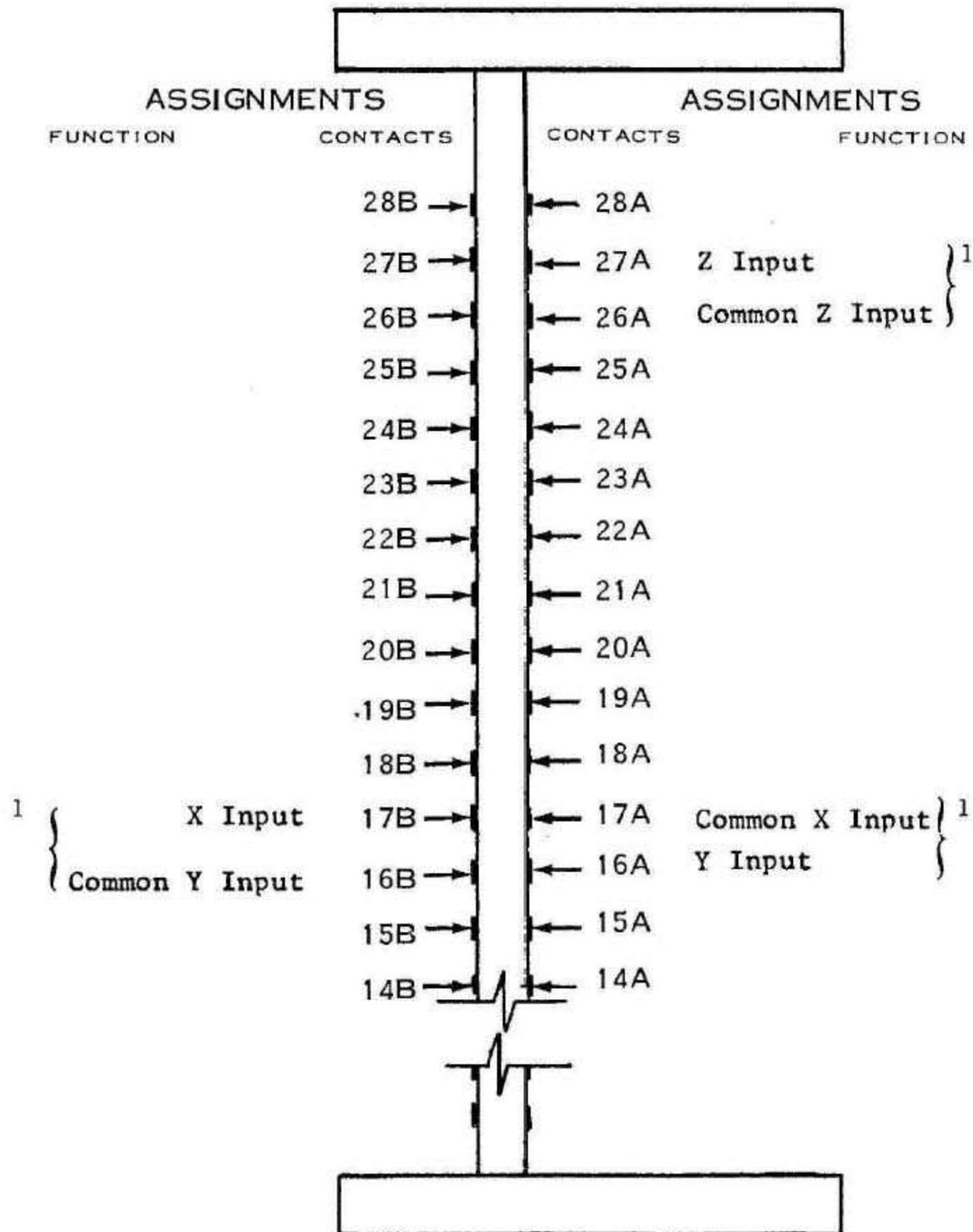

1 Customer installed wiring required.

## CAUTION

When a Power Module compartment has been selected for the MR 501 and wired for a specialized interface system, a plastic barrier (Tektronix Part Number 214-1593-02) should be installed in a key slot between contacts 21 and 22 on the Power Module.

Do not insert any TM 500 Series plug-in in a live Power Module and do not use excessive force when inserting the plug-in.

## INTERFACE NOTES

### Z Input

The Z-axis input signal can be applied to contact 27A by unsoldering the coaxial cable from the Z front-panel input connector and soldering it to contact 27A. A +5 V signal turns the crt beam on from a zero volt, off condition. The input resistance is 10 k $\Omega$ .

### X Input

To apply the horizontal (X) input signal to contact 17B, disconnect the resistor from the X front-panel input connector and solder the center conductor of a length of miniature coaxial cable to the disconnected end of the resistor. Solder the unconnected end of the X input cable to contact 17B (center conductor) and 17A (common). The input resistance is 1 M $\Omega$ .

### Y Input

To apply the vertical (Y) input signal to contact 16A, disconnect the resistor from the Y front-panel input connector and solder the center conductor of a length of miniature coaxial cable to the disconnected end of the resistor. Solder the unconnected end of the Y input cable to contact 16A (center conductor) and 16B (common). The input resistance is 1 M $\Omega$ .

### Common (Z Input, X Input, and Y Input)

Contacts 26A, 17A and 16B are electrically tied to the instrument chassis. Certain contacts are recommended for specific use for connection convenience.

@

# **SECTION 12**

## **PULSE GENERATORS**



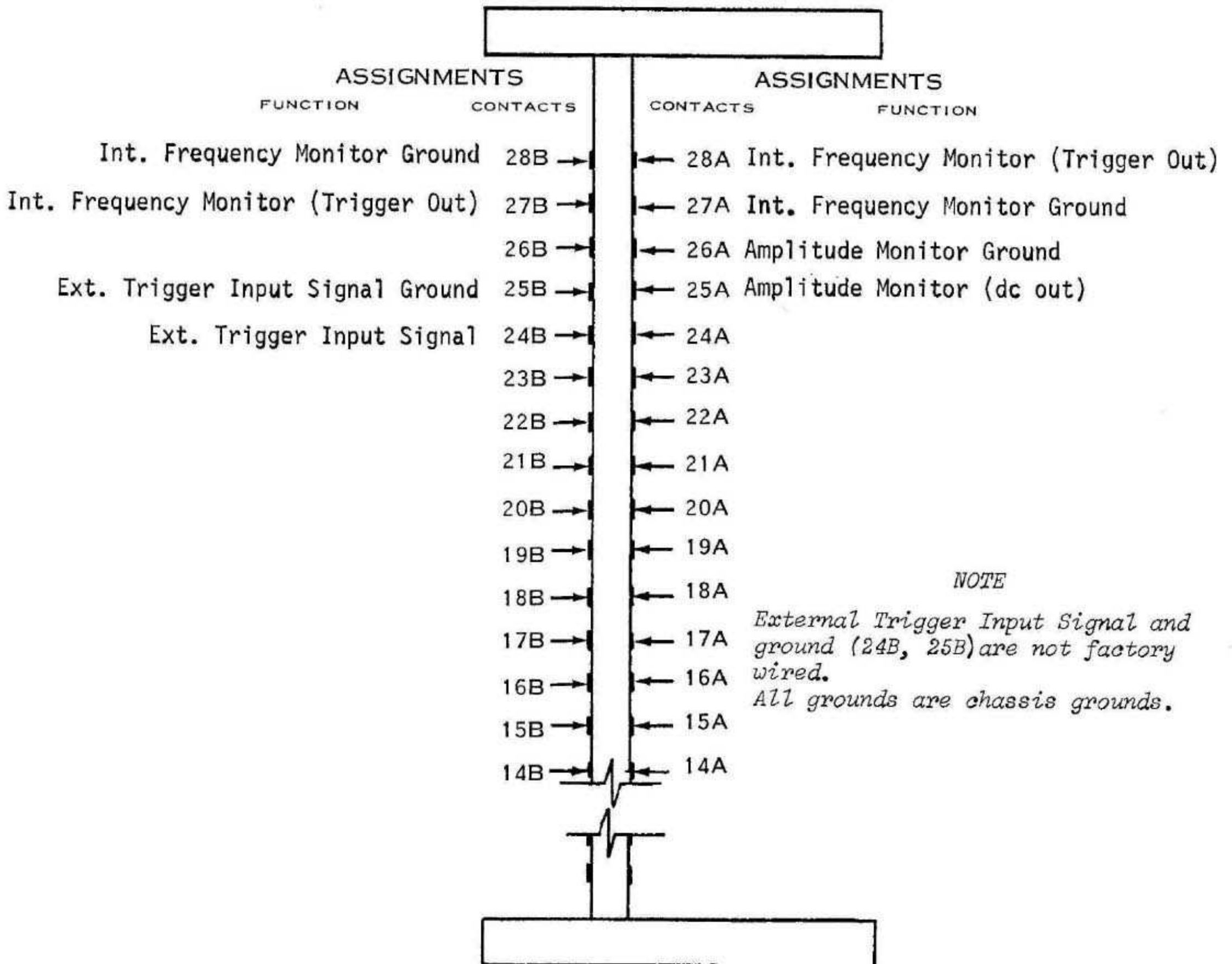

## Plug-In or Power Module Rear View

**CAUTION**

When a Power Module compartment has been selected for the PG 501 and wired for a specialized interface system, a plastic barrier (Tektronix Part Number 214-1593-02) should be installed in a key slot between contacts 23 and 24 on the Power Module.

Do not insert any TM 500 Series plug-in in a live Power Module and do not use excessive force when inserting the plug-in.

## INTERFACE NOTES

## Internal Frequency Monitor (Trigger Out)

Contacts 28A and 27B are connected together on the circuit board. These contacts provide a square wave pre-trigger with transition times occurring approximately 10 ns before the output pulse. This trigger is the complement of the front panel TRIG OUT signal. The open circuit output voltage varies between 0 V and 1 V and is in phase with the negative pulse output from a source impedance of 27  $\Omega$ . Changing R55 to 51  $\Omega$  increases the maximum output voltage to 2 V. Only period adjustments affect this square wave. These contacts may be shorted to ground without causing damage. Use contacts 27A/28B or both as ground returns.

## Amplitude Monitor (dc out)

This output, contact 25A, may be used to accurately set the plus or minus output amplitude. The polarity of the voltage at this contact is selected by the Amplitude Monitor slide switch located in the center of the A board. Connect a high impedance voltmeter to this contact. Use contact 26A as ground. Set the PULSE DURATION control to the LOCKED ON position. Now adjust the selected OUTPUT AMPLITUDE (VOLTS) control for the desired amplitude. The source resistance for this contact is 27 k $\Omega$ .

## External Trigger Input Signal

Contact 24B and its ground, 25B, are assigned to External Trigger Input Signal. These assignments are not factory wired. They provide the same feature as the front panel TRIG/DURATION IN connection. To use these connections, disconnect the coaxial cable from the front panel TRIG/DURATION IN bnc connector and reconnect the center conductor to 24B and the shield to 25B. Set the PERIOD selector to the EXT TRIG position and the PULSE DURATION control to the desired duration time or to the EXT DURATION position. In the latter position, the TRIG/DURATION signal controls both the frequency and duration of the output. When the PULSE DURATION control is not in the EXT DURATION position and the PERIOD control is in EXT TRIG position, the external TRIG/DURATION IN signal triggers the output pulse, and the duration is determined by the PULSE DURATION control settings.

## Plug-In or Power Module Rear View

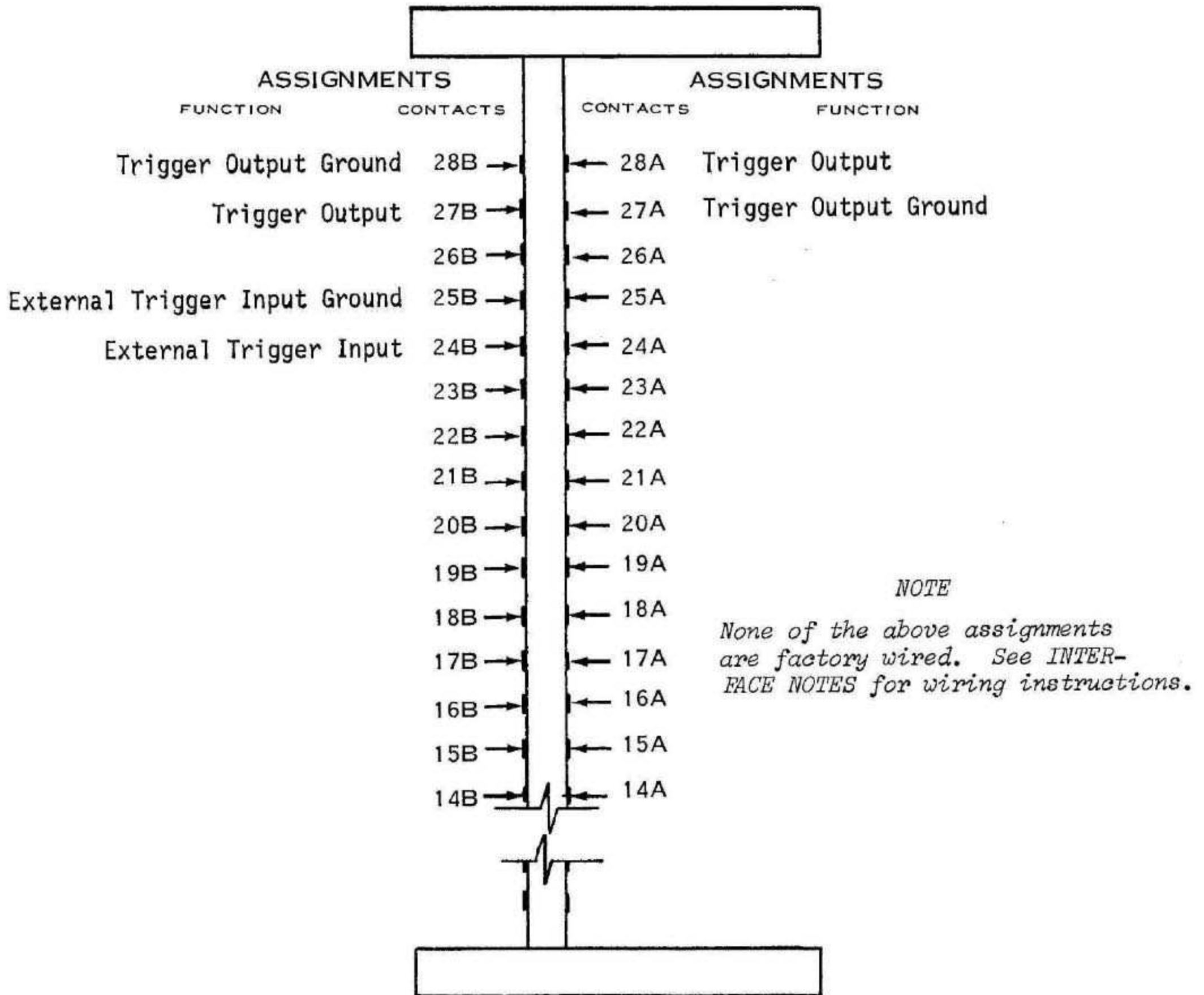

### CAUTION

When a Power Module compartment has been selected for the PG 502 and wired for a specialized interface system, a plastic barrier (Tektronix Part Number 214-1593-02) should be installed in a key slot between contacts 23 and 24 on the Power Module.

Do not insert any TM 500 Series plug-in in a live Power Module and do not use excessive force when inserting the plug-in.



## INTERFACE NOTES

## Trigger Output Signal

Contacts 28A and 27B are connected together on the circuit board as are ground contacts 27A and 28B. To obtain a + TRIG OUT signal at the rear interface connectors, pull the coaxial cable from the front panel + TRIG OUT connector and the Timing Circuit Board. Replace this cable with a miniature 50- $\Omega$  coaxial cable about ten inches long. Insert one end of the cable in the connector on the Timing Board (do not solder) and the other end to the connector on the Output Board (near the assigned rear interface connectors). If a coaxial cable with prepared end adapters is available, simply plug the ends of the cable into the connectors. The amplitude of this pulse is at least 1 V into 50  $\Omega$ . There is a fixed delay of about 10 ns between the leading edges of the trigger pulse and the output pulse. Be certain that coaxial cable shields are grounded.

## Complementary Trigger Output Signal

To obtain a complementary (opposite polarity) trigger signal, connect a 50- $\Omega$  coaxial cable from the holes marked Internal Trig Out on the Timing Board. The center conductor of the coaxial cable connects to the hole marked + and the shield to the hole marked Gnd. Connect the other end of this cable to the connector on the A side of the Output board near connector 28 and 27. This provides outputs on the same connectors as the Trigger Output Signal described above. These connections do not interfere with the + TRIG OUT signal. A one-half volt signal into 50  $\Omega$  is available at these connections

## Trigger/Duration Input

Connections for this input can also be transferred to the rear interface connector. Disconnect the cable from the front panel + TRIG/DURATION INPUT and the connector labeled Trig In on the Timing Board. Pull the cable to remove the ends from the connections. Now connect a piece of 50- $\Omega$  coaxial cable about ten inches in length from the Trig In connections on the Timing board to the holes connected to contact 25B (ground) and 24B (center conductor). Solder the cable in the rear connector holes and insert the other end in the connector on the Timing Board or obtain a cable with the proper adapters.

Set the PERIOD selector to the EXT TRIG position and the PULSE DURATION control to the desired duration time or to the EXT DURATION position. In the latter position, the +TRIG/DURATION INPUT signal controls both the frequency and duration of the output. When the PULSE DURATION control is not in the EXT DURATION position and the PERIOD control is in EXT

TRIG position, the external +TRIG/DURATION INPUT signal triggers the output pulse. The duration of the output pulse is determined by the PULSE DURATION control setting.

#### Pulse Fidelity

It is important to remember that when using the rear interface connectors some pulse degradation may occur due to increased cable lengths or additional capacity introduced by the rear interface connections, etc.



## Plug-In or Power Module Rear View

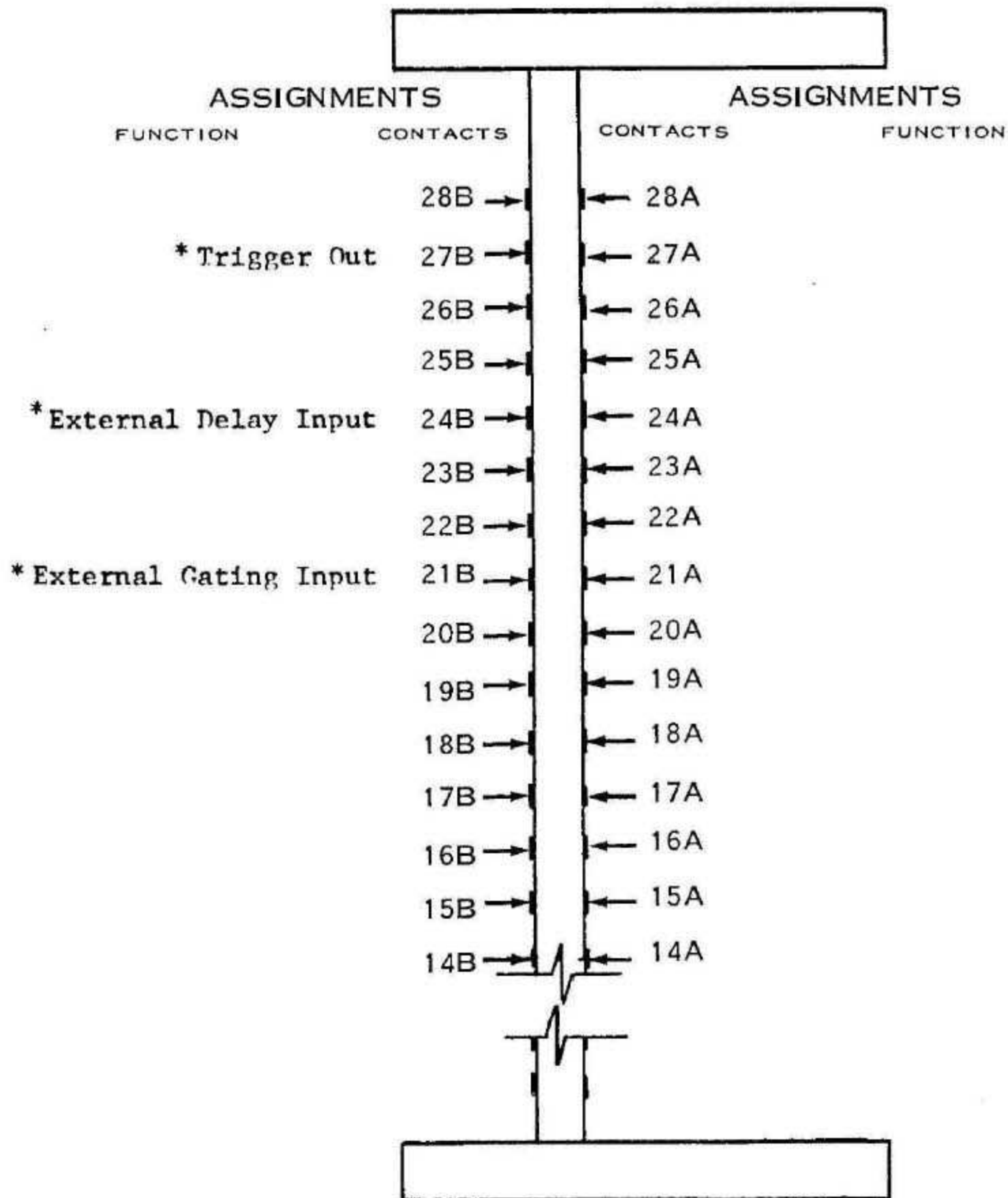

\* NOTE: Use contacts 9A or 9B for common ground.

### CAUTION

When a Power Module compartment has been selected for the PG 505 and wired for a specialized interface system, a plastic barrier (Tektronix Part No. 214-1593-02) should be installed in a key slot between contacts 23 and 24 on the Power Module.

Do not insert any TM 500 Series plug-in in a live Power Module and do not use excessive force when inserting the plug-in.



## INTERFACE NOTES

### Trigger Out

Contact 27B is in parallel with the front-panel TRIG OUT connector.

### External Delay Input

Interface contact 24B is connected in parallel with the INPUT front-panel connector.

### External Gating Input

Contact 21B is used to gate off the free-running period generator. Apply a 5 volt positive-going pulse whose duration is the same as the off time desired. Gating the pulse generator may cause some time distortion to the first and last pulse of a pulse string.

## PLUG-IN OR POWER MODULE REAR VIEW

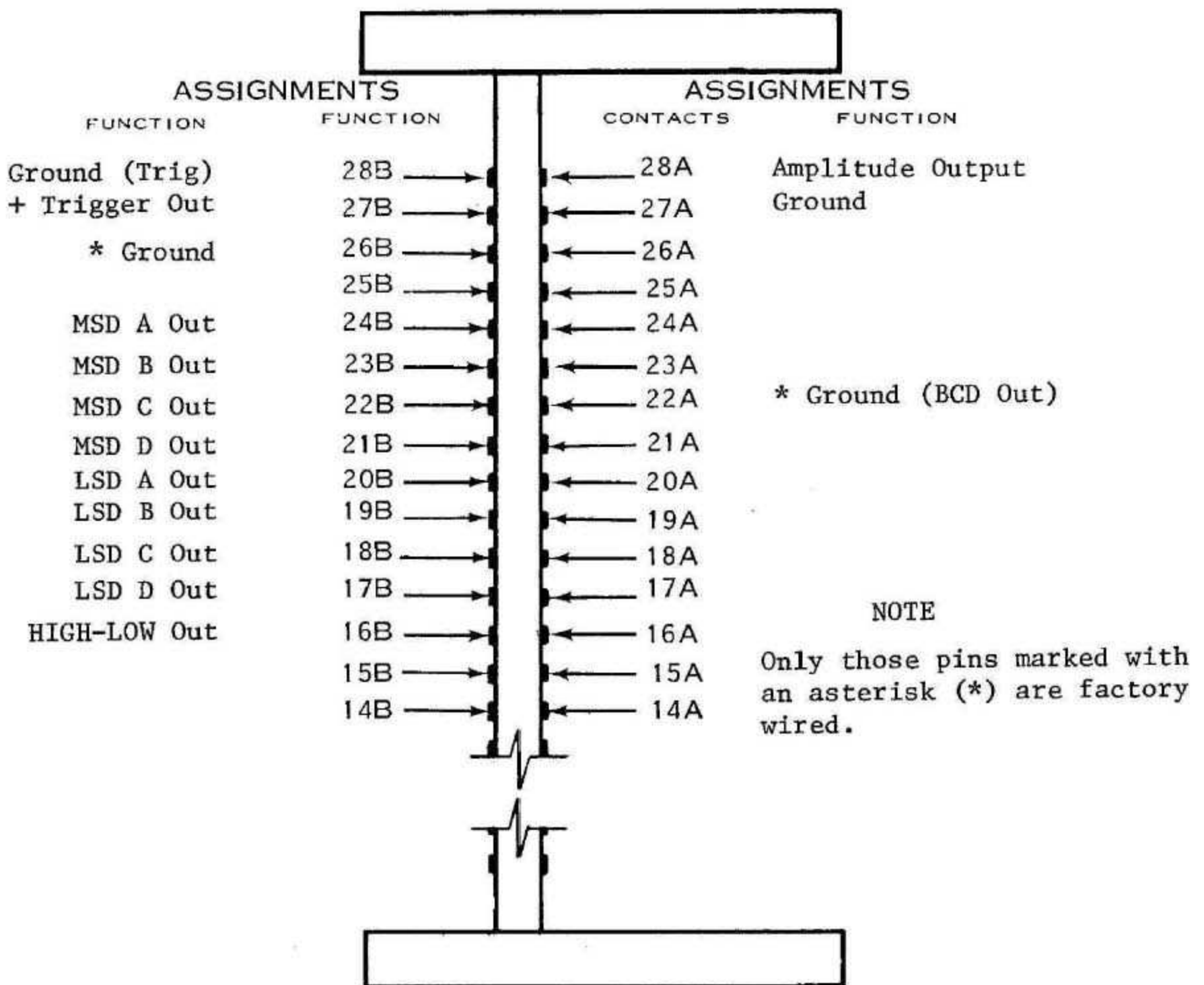

## CAUTION

When specialized rear interface wiring has been added to a Power Module compartment, the PG 506 may not be fully compatible with all other members of the signal source family. Trigger output (27B and 28B) and main output (28A and 27A) are compatible, as is the ground on 26B. The ground on 22A is not compatible with certain instruments, nor is the bcd information on 17B through 24B and the HIGH-LOW output on 16B. A plastic barrier (Tektronix Part Number 214-1593-02) should be installed in the key slot between contacts 23 and 24 on the power module. However, before inserting any other TM 500 signal source in a compartment with PG 506 interface wiring, check the diagrams in this book for pin-by-pin compatibility. Likewise, do not insert a PG 506 into a slot with rear interface wiring for any other signal source family connection without making the same compatibility check.

Do not insert any TM 500 Series plug-in in a live Power Module and do not use excessive force when inserting the plug-in.

## NOTE

The pin assignments shown above for customer-installed connections inside the PG 506 are different in some respects than those shown earlier in PG 506 manuals.

## INTERFACE NOTES

### Amplitude Output

To obtain the AMPL OUTPUT signal at the rear interface connectors, disconnect the coaxial cable from the main board (located in the lower left hand corner of the B side). Replace this cable with a miniature 50  $\Omega$  coaxial cable (Tektronix Part No. 175-1827-00). Remove the coaxial connector from the other end, and solder the cable to the rear interface connector as follows:

Shield to 27A (3rd hole down from top on the B side)  
Center conductor to 28A (4th hold down on the B side)

See Fig. 1 for pictorial interface connection detail.

### NOTE

*Connecting front panel signals to the rear interface will degrade their performance slightly.*

### Trigger Output

To connect TRIG OUT to the rear interface, disconnect the coaxial 50  $\Omega$  lead to the front panel at the DVM board end (located in the upper right-hand corner as viewed from the rear). Replace this cable with a miniature 50  $\Omega$  coaxial cable (Tektronix Part No. 175-1826-00). Remove the coaxial connector from the other end, and solder the cable to the rear interface connector as follows:

Shield to 28B (2nd hole down from top on the A side)  
Center Conductor to 27B (5th hole down on the A side)

See Fig. 1 for pictorial interface connection detail.

### NOTE

*Ground connections to 26B and 22A are the only rear interface signal connections that are factory wired.*

## INTERFACE NOTES (cont.)

## MSD &amp; LSD Outputs

To obtain readout information at the interface, use flat ribbon-wire to connect this digital information to the through-plated holes as shown in Fig. 1 and according to the following list:

MSD A to 24B	}	6 lead flat ribbon-wire
MSD B to 23B		
MSD C to 22B		
MSD D to 21B		
LSD A to 20B		
LSD B to 19B		

LSD C to 18B	}	3 lead flat ribbon-wire
LSD D to 17B		
Hi-Lo to 16B		

## NOTE

*Each of the MSD and LSD outputs is only capable of driving one TTL load. The active level of each output is high.*

*For the Hi-Lo Output, output is low when the HIGH display light on the front panel is on.*



# LOCATIONS FOR USER WIRED REAR INTERFACE CONNECTIONS

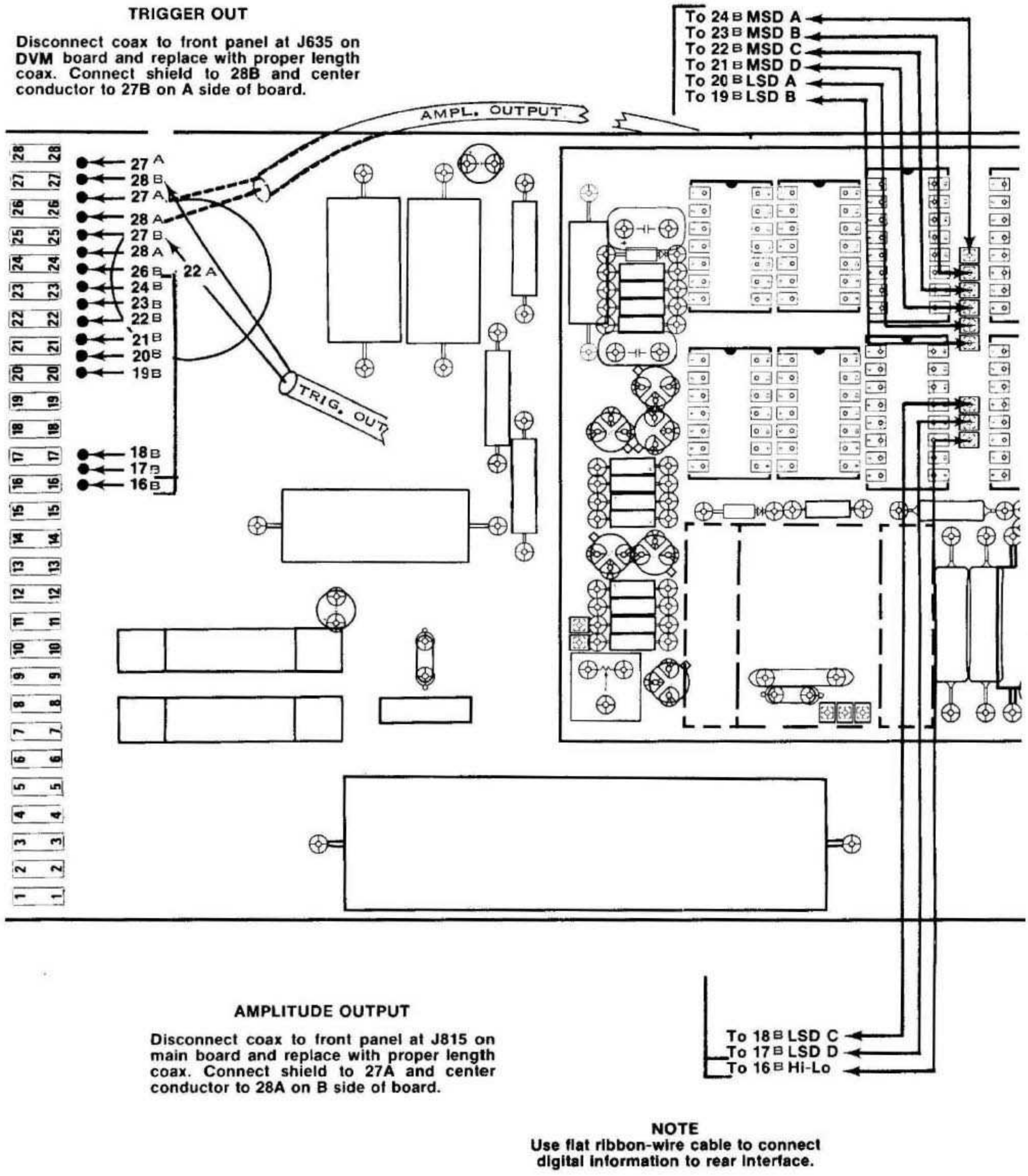
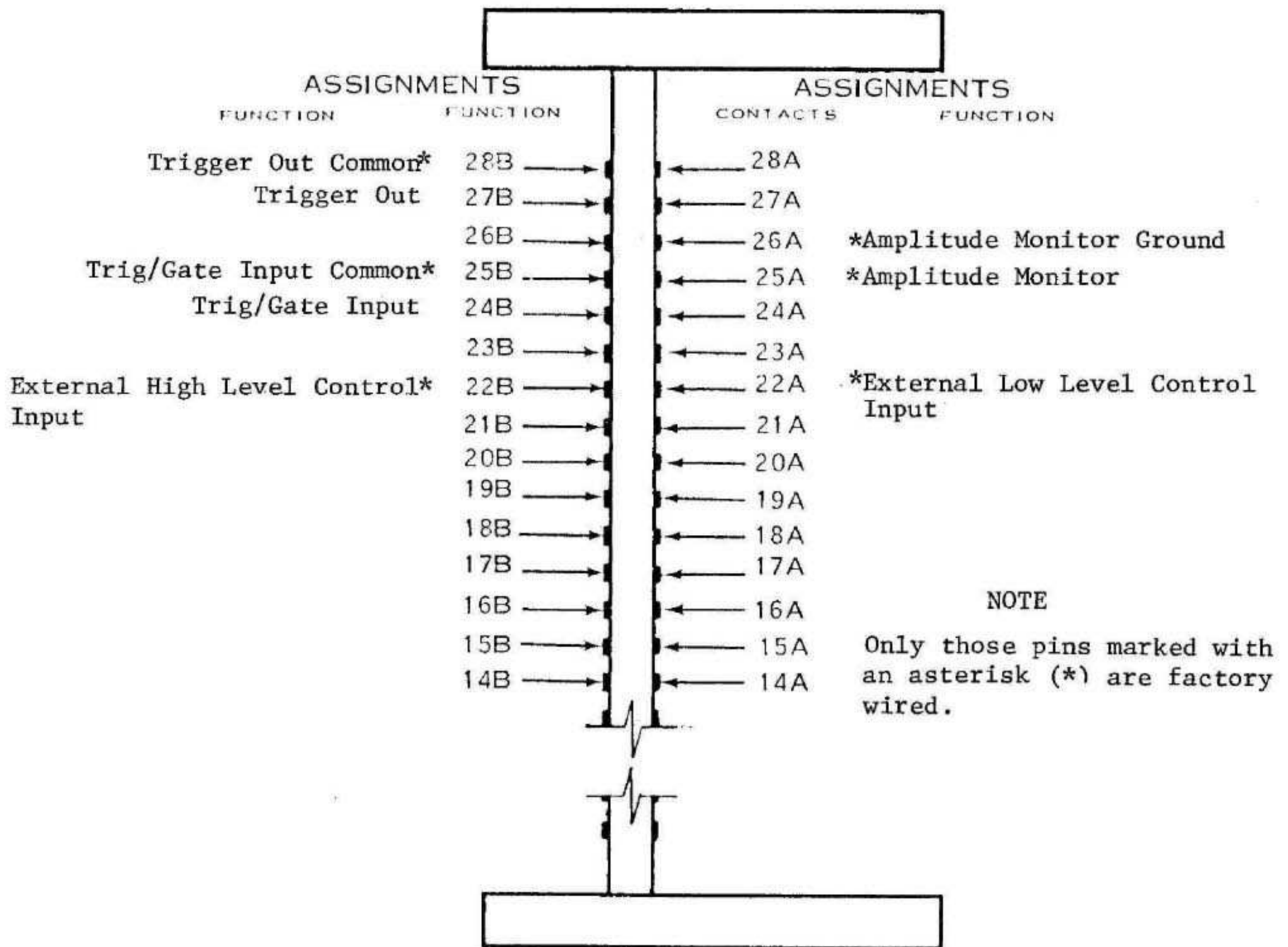

FIG. 1. PARTIAL A SIDE OF MAIN INTERFACE BOARD SHOWING AMPLITUDE AND TRIGGER CABLE CONNECTION.

# PLUG-IN OR POWER MODULE REAR VIEW



### CAUTION

*When a Power Module compartment has been selected for the PG 508 and wired for a specialized interface system, a plastic barrier (Tektronix Part Number 214-1593-02) should be installed in the key slot between contacts 23 and 24 on the Power Module.*

*Do not insert any TM 500 Series plug-in in a live Power Module and do not use excessive force when inserting the plug-in.*

## Using The Rear Interface Connectors

See the accompanying chart for rear interface connector assignments. For other functions not detailed here, the small auxiliary board (E) has numerous connectors available. Use the connections to make custom inputs or outputs to the PG 508 through the Power Module.

## Amplitude Monitor

These pins (25A) are connected to the OUTPUT terminal through a 27 k resistor and ground (26A). To use this function place the PERIOD control in the EXT TRIG OR MAN position and connect an accurate voltmeter to these terminals. Now adjust the TRIG/GATE LEVEL control cw for the high steady state output voltage and ccw for the low steady state output voltage. In this manner, the output pulse amplitude levels may be precisely monitored and set.

## External Level Control Inputs

The high and low level output voltages can be controlled externally through pins 22B and A at the rear interface connector. Fig. 1 shows the equivalent circuit. Connections must be made from pad K to pad L and pad M to pad N located as shown on Fig. 2. Use ordinary hook-up wire of the proper length. Solder the wire to the pads. Also note the location of the Ext Hi and Ext Lo potentiometers on the output board.

To use this feature set the front panel controls as follows: depress the PRESET button (PRESET), place the PERIOD switch in the EXT TRIG OR MAN position, the DURATION in EXT DUR and the NORM COMPLEMENT switch in the NORM position (out). Use a screwdriver to center the Ext Hi and the preset HIGH LEVEL controls. Supply a voltage to the external high input (pin 22B on the rear interface connector) equal to the highest external input voltage desired (maximum 20 V). Now adjust the Ext Hi potentiometer (on circuit board) for an OUTPUT voltage equal to the maximum desired output voltage. It may be necessary to adjust the preset LOW LEVEL control as the OUTPUT voltage is limited to 20 V peak to peak open circuit. The high level OUTPUT voltage is clamped by the low level OUTPUT voltage if this range is exceeded. Now apply a voltage equal to the lowest external control voltage desired to the same rear interface connector (pin 22B). Adjust the front panel preset HIGH LEVEL until the lowest desired output voltage is obtained. It may be necessary to adjust the preset LOW LEVEL control to obtain the desired output. The high level OUTPUT voltage cannot go below the low level OUTPUT voltage due to the level control voltage clamps. The Ext Hi and the preset HIGH LEVEL controls interact. It may be necessary to repeat the above procedure several times until the desired results are obtained. Now push the NORM COMPLEMENT switch (COMPLEMENT). Center the Ext. Lo and preset LOW LEVEL potentiometers. Supply a



voltage to pin 22A of the rear interface connector equal to the highest external control voltage desired. Adjust the Ext Lo potentiometer (on circuit board) for an OUTPUT voltage equal to the highest OUTPUT voltage desired. Change this voltage to the lowest desired external control voltage. Adjust the front panel preset LOW LEVEL control for the lowest OUTPUT voltage desired. As these adjustments interact, readjust the preset LOW LEVEL and the Ext Lo potentiometers for the desired results. Do not readjust the preset HIGH LEVEL or the Ext Hi potentiometers. The OUTPUT voltages now vary linearly and independently with the external control voltages.

### Trig/Gate Input

These assignments provide rear interface input capabilities for the front panel TRIG/GATE IN input. The signal lead (24B) must be user installed but the ground (25B) is factory wired. To make the proper connections, remove the cable extending from the TRIG/GATE IN connector to the input board by pulling the end from the socket on the board. Install a twelve inch cable with the proper connectors, Tektronix Part Number 175-1827-00, from the connector on the input circuit board labeled Trig/Gate In to the other connector on the output board labeled Trig/Gate In as shown in the illustration.

### Trigger Output

The signal lead (28B) must be user installed; the ground (27B) is factory wired. To route this function through the rear interface connector remove the plug on the timing circuit board connected to the cable from the + TRIG OUT front panel connector. This plug is shown on the illustration and is labeled Trig Out. Connect a six inch cable with the proper connectors, Tektronix Part Number 175-1824-00, from the connector labeled Trig Out in the illustration to the connector on the output board labeled + Trig Out in the illustration. To obtain the complement trigger out signal connect the coaxial cable to the connector labeled Trig Comp in the illustration. The normal trigger output may be used simultaneously with the complement, through the rear connector, without disturbing the operation of either.

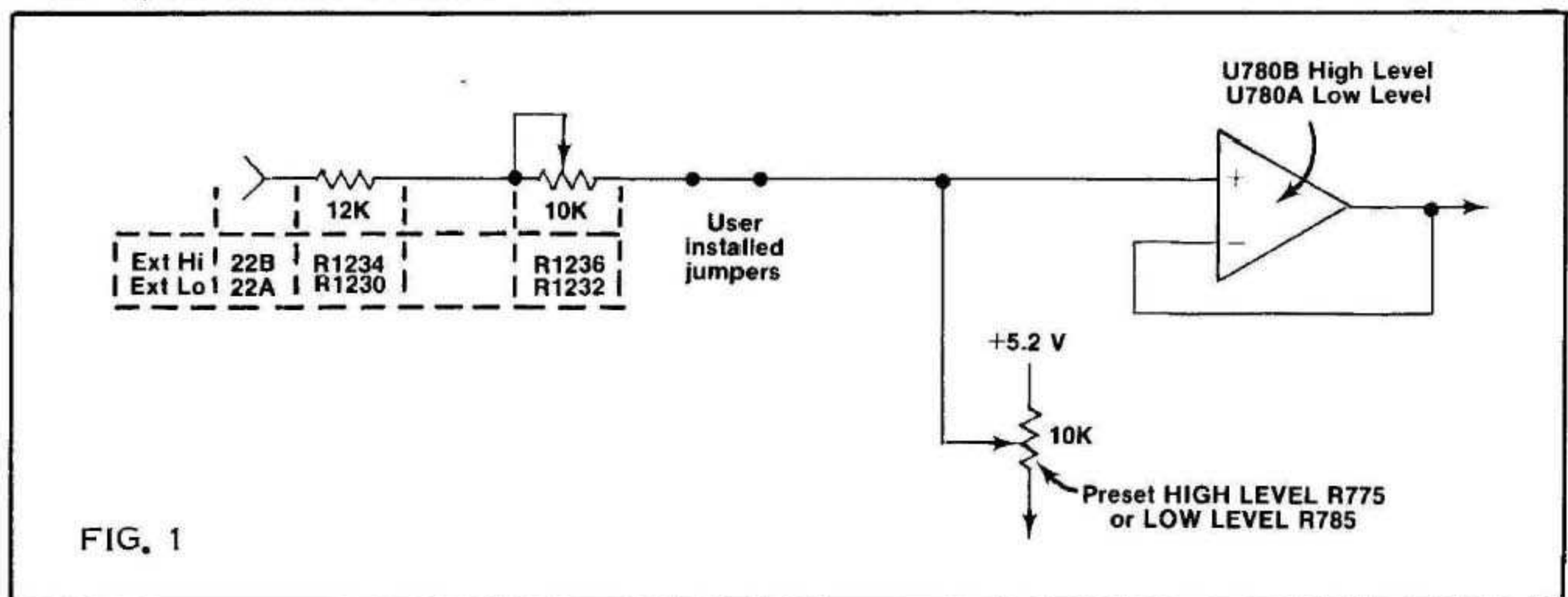



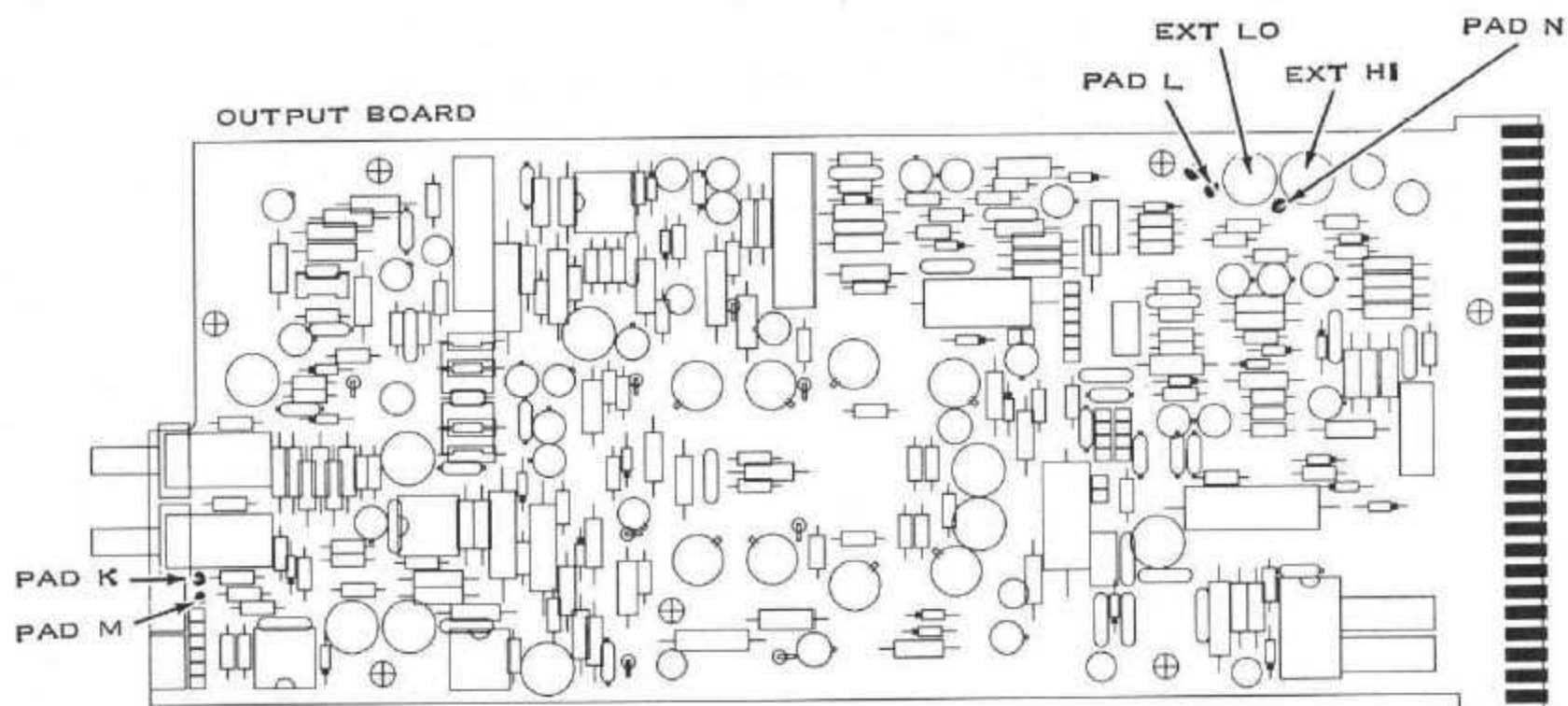

FIG. 2

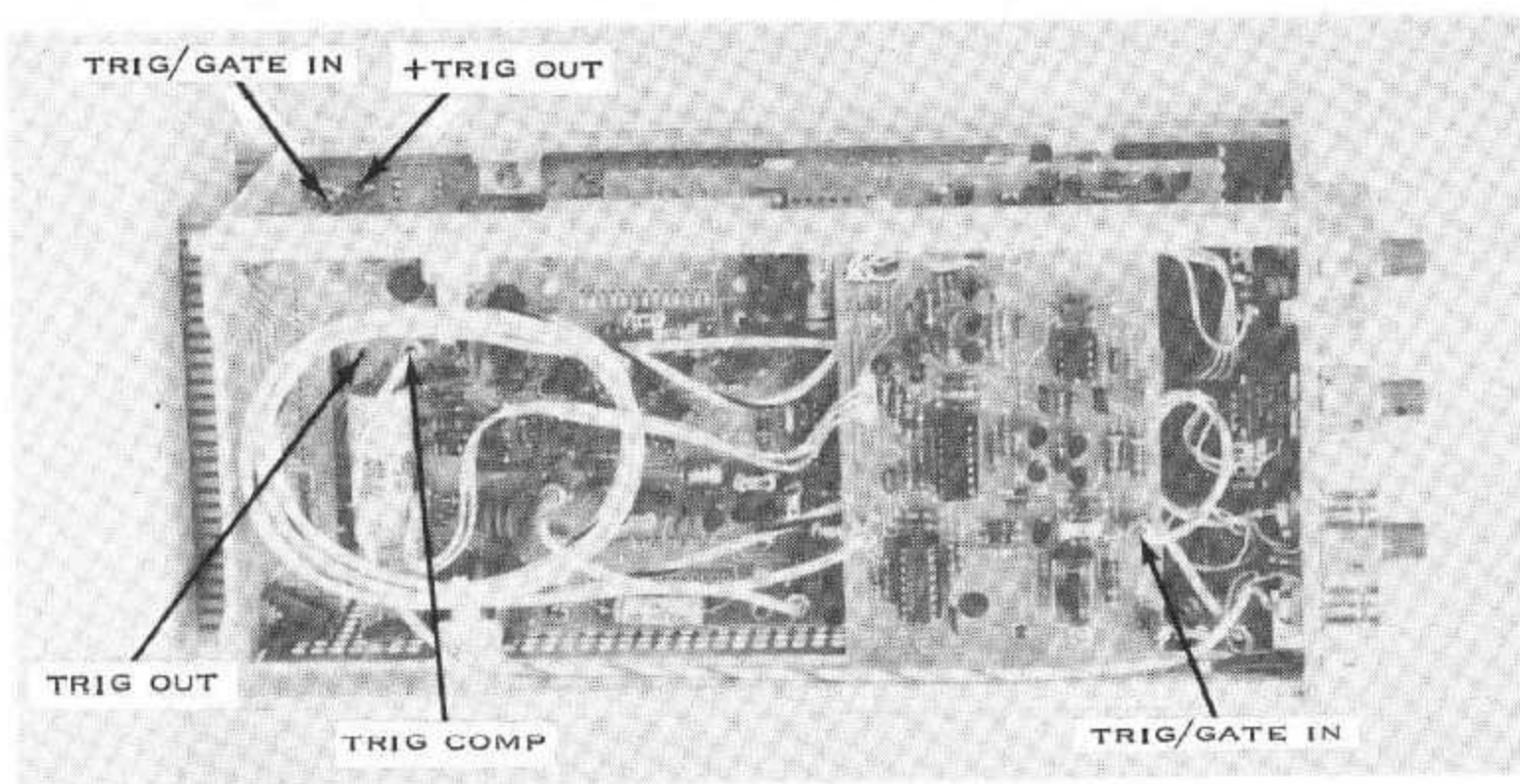

FIG. 3

# **SECTION 13**

## **POWER SUPPLIES**



## Plug-In or Power Module Rear View

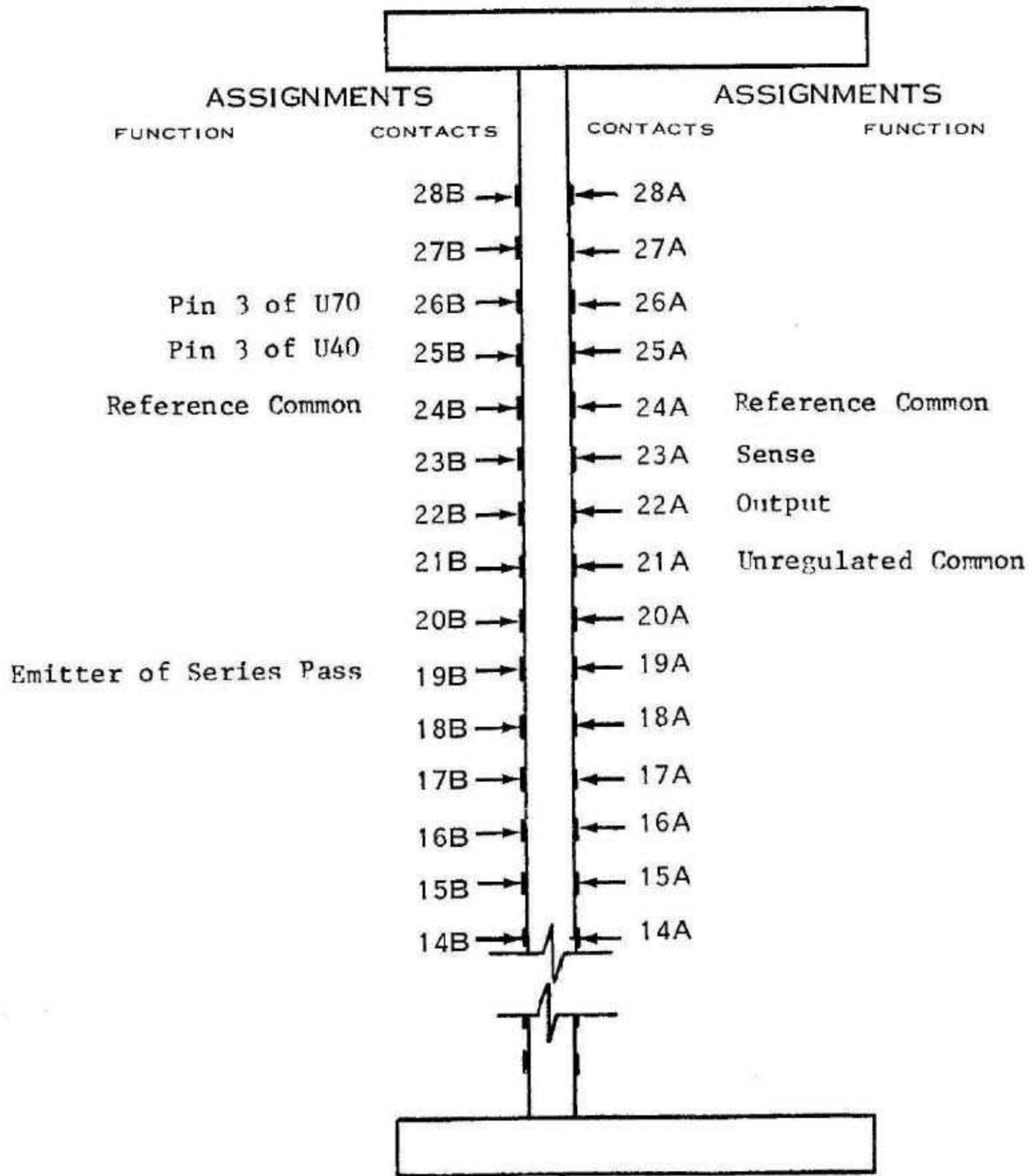

**CAUTION**

*When a Power Module compartment has been selected for the PS 501, PS 501-1 or PS 501-2 and wired for a specialized interface system, a plastic barrier (Tektronix Part No. 214-1593-02) should be installed in the Key Slot between contacts 19 and 20 on the Power Module.*

*Do not insert any TM 500 Series plug-in in a live Power Module and do not use excessive force when inserting the plug-in.*



## INTERFACE NOTES

### INTRODUCTION

Remote programming, powering and sensing of some load under the Power Module Option 2 capabilities may be desirable. Thorough understanding of the schematic diagram and the exact internal connections for Input/Output lines to the rear contacts will be an aid in designing the specialized TM 500 interface system.

### Model Deviations

PS 501-1 has several part values different than those used in the other two models of this instrument. The output voltage between J50 and J52 is a constant gain factor greater than the voltage applied to Pin 3 of U40 with respect to J52. The gain factor for the PS 501-1 is theoretically 2.22, while the theoretical gain factor for the other two versions of this instrument is 3.23. Also, there are parts tolerances within the calibration range of these instruments that can cause further deviations in this gain factor.

To measure the gain factor of your individual instrument, adjust it for exactly 20 V out (between J50 & J52). Measure the voltage at pin 25B with respect to reference common on 24A/24B. (This will give you the voltage applied to Pin 3 of U40.) Now, divide 20 V by the voltage measured between 25A and 24A/24B. This answer is the gain factor of your individual unit. This factor times whatever appropriate + voltage you apply to Pin 25B with respect to 24A/24B will be the output voltage of your unit. Be sure to disconnect the wiper arm of R42A, (see Fig. 1 for suggested point for opening this circuit) before applying the external voltage to pin 25B.

If the output voltage is taken from pin 22A with respect to reference common (24A/24B) then remote sense at pin 23A should also be connected to the load and the sensing lead to J50 should be opened up at point "P" see Fig. 2 for suggested point for opening this circuit. Sensing of the load voltage at the load gives the best regulation. You will note that reaching point "P" with a soldering iron is best achieved on the Pin 24B side of the circuit board.

### PS 501 I/O Functions and Limitations

Reference Common (both 24A & 24B in preference to 21A or possible 21B). 24A & 24B are the common return for the + voltage offered by this supply. It can be ground referenced, elevated or left open. It is suggested that elevation of this point does not exceed a +300 V with respect to ground.

Sense (23A). This is a reasonably high impedance input (close to 1.6 k $\Omega$ ), even when current limiting takes place. When remote load voltage sensing is connected

to this point, be sure to open the front panel voltage sensing circuit at point "P" (see Fig. 2). Sensing of the voltage at the load gives the best regulation.

+ Output (22A). This is the low impedance source of the voltage developed by this unit as dictated by the gain of the individual unit times the + voltage applied to Pin 3 of U40 with respect to reference common. This is done by adjusting R42A or (after opening the wiper arm of R42A, see Fig. 2) applying an appropriate + voltage to 25B with respect to reference common. Maximum current available here cannot exceed 500 mA; however, current limiting at levels below this can be achieved by setting R65 (the Current Limit front panel control).

Unregulated Common (21A). This is part of the common lead circuitry (along with 24A/24B) but there is a slight resistance to this lead due to the long board runs associated with it (approximately 2 milliohms).

Pin 3 of U40 (25B). This Input has a 10 k $\Omega$  resistance to pin 3 of U40. Pin 3 of U40 is also a high impedance input, so voltages applied to 25B will show up accurately at Pin 3. External programming of the output voltage of this unit can be achieved by applying an appropriate positive to this input after making sure the wiper arm of R42A has been opened up, see Fig. 1. The output voltage of this unit will be this unit's gain factor times the voltage applied to this point. (For gain factor, see Model Deviations.) Do not program this unit to develop an output voltage between 22A and 24A greater than 20 volts (also, 22A should be + with respect to 24A).

Pin 3 of U70 (26B). This is an external current limiting control point. If it is left open (no connection made to it) current limiting takes place as controlled by the front panel CURRENT LIMIT pot. If 26B is connected to 19B, the current limiting feature is completely disabled. If fixed at 0.6 volt below reference common, this supply is shut down and will not operate.

*NOTE*

*The +5 volts with a maximum 1 A current capability is not available at the rear interface connector.*

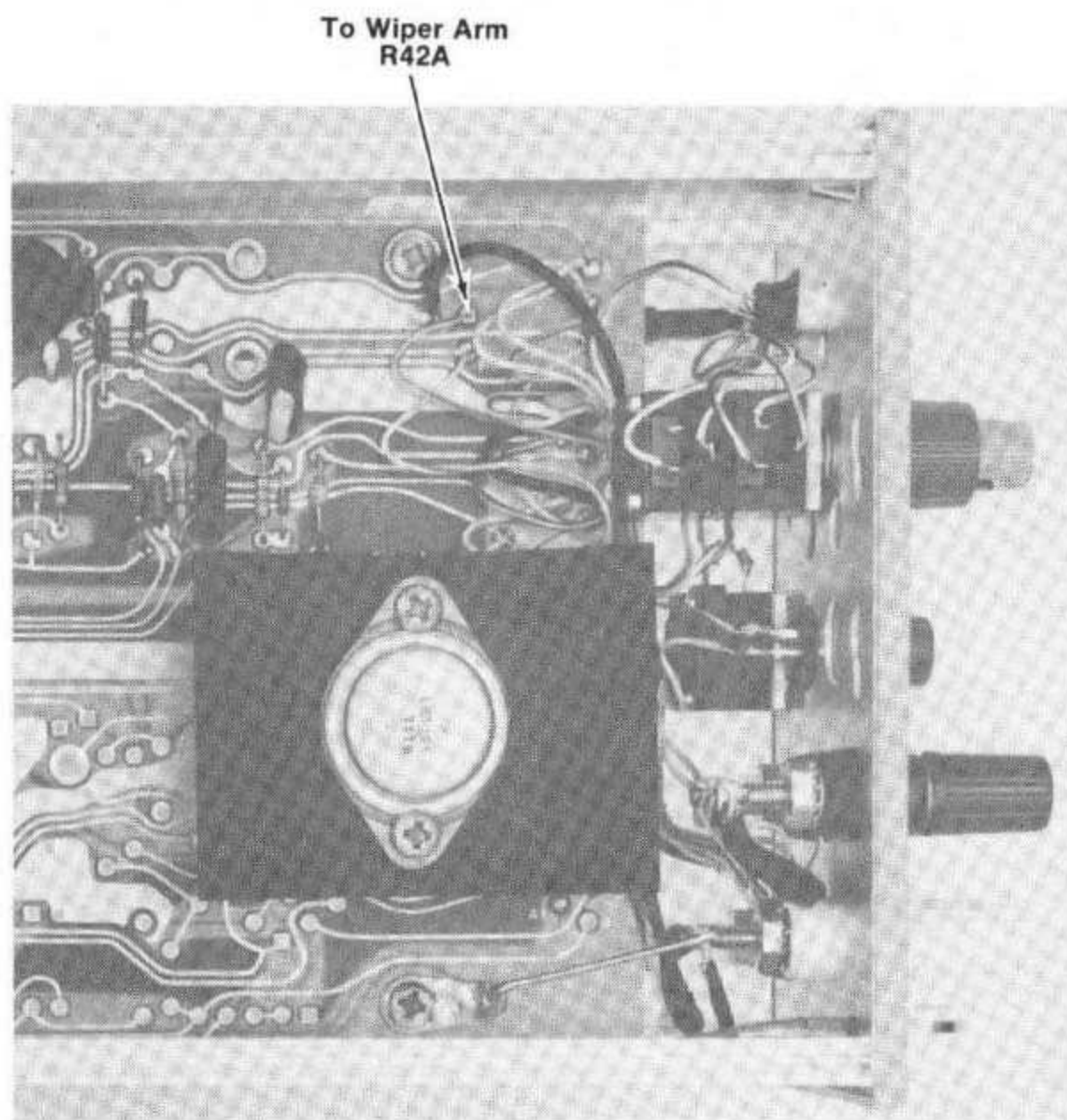

Fig. 1. Disconnect lead go to this pad to open wiper arm circuit of R42A.



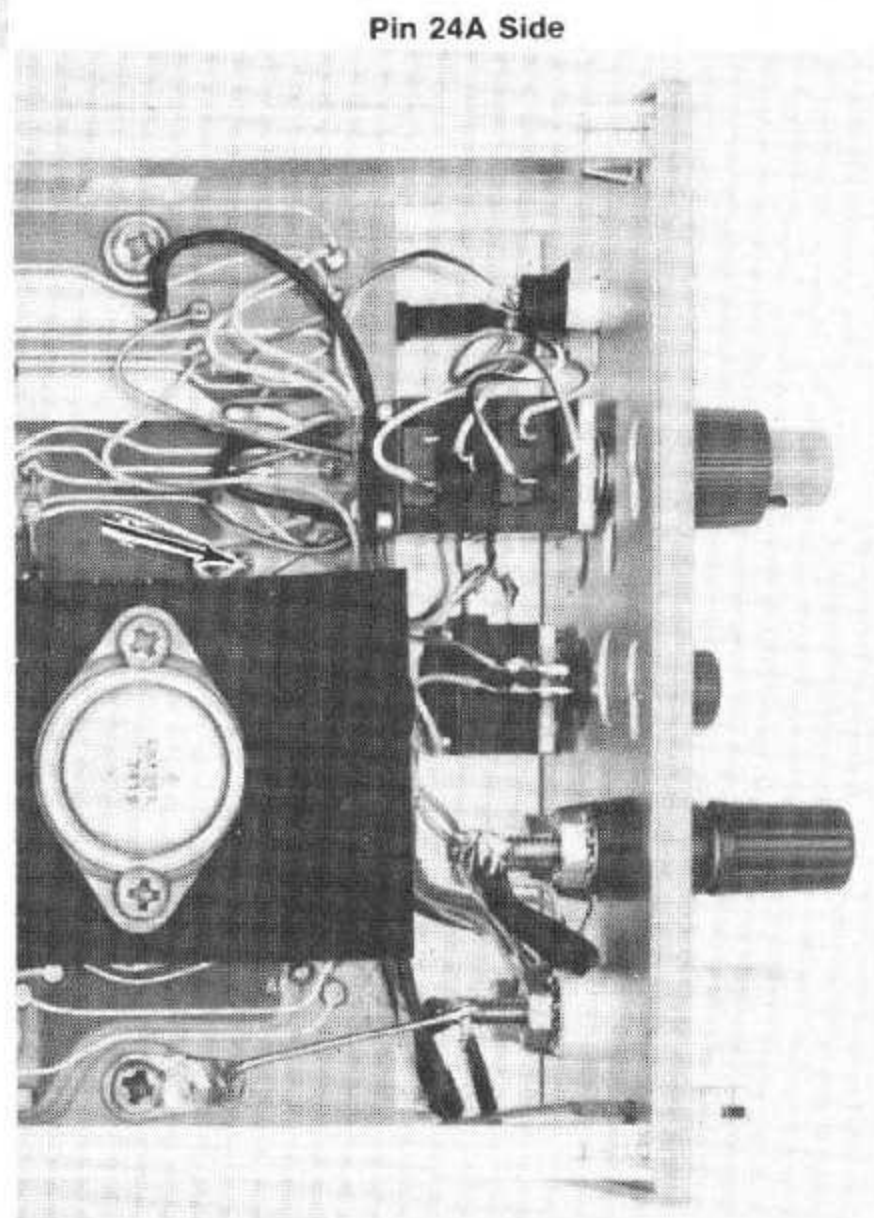
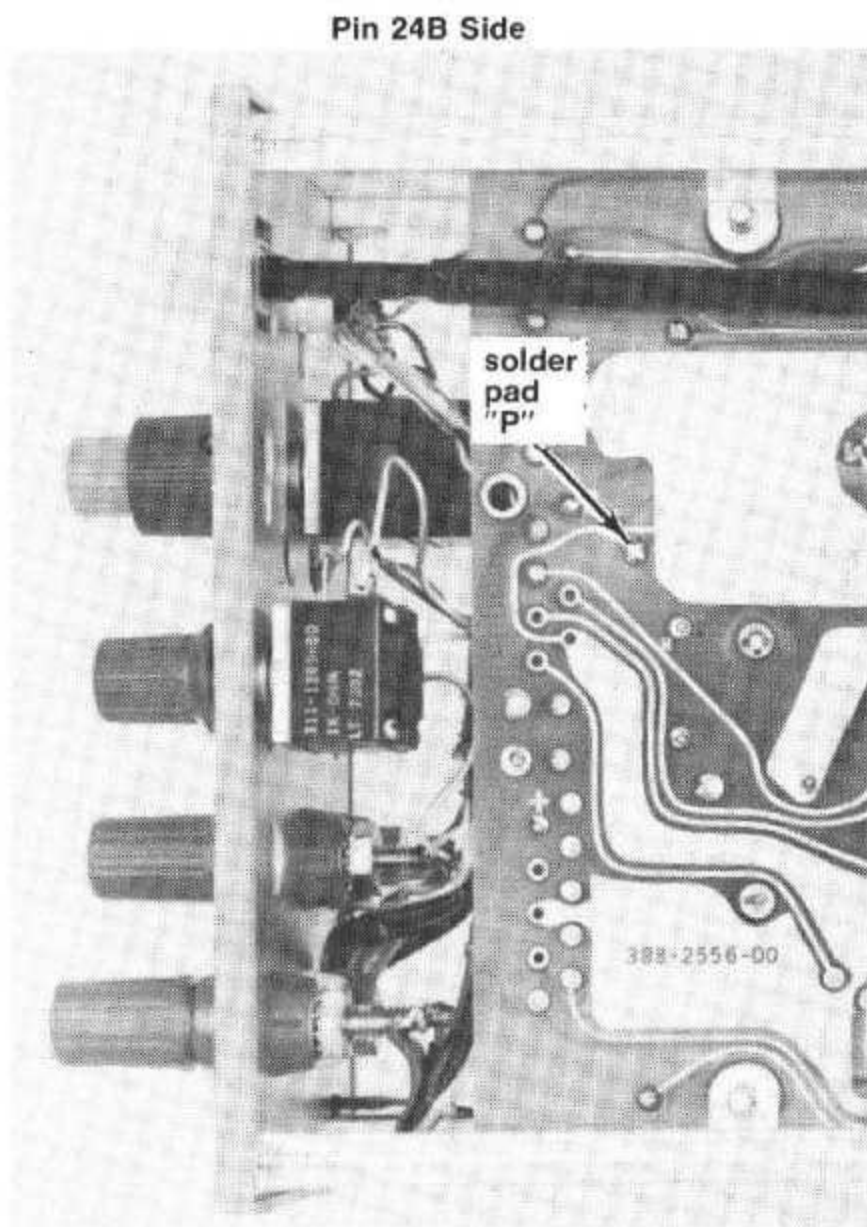
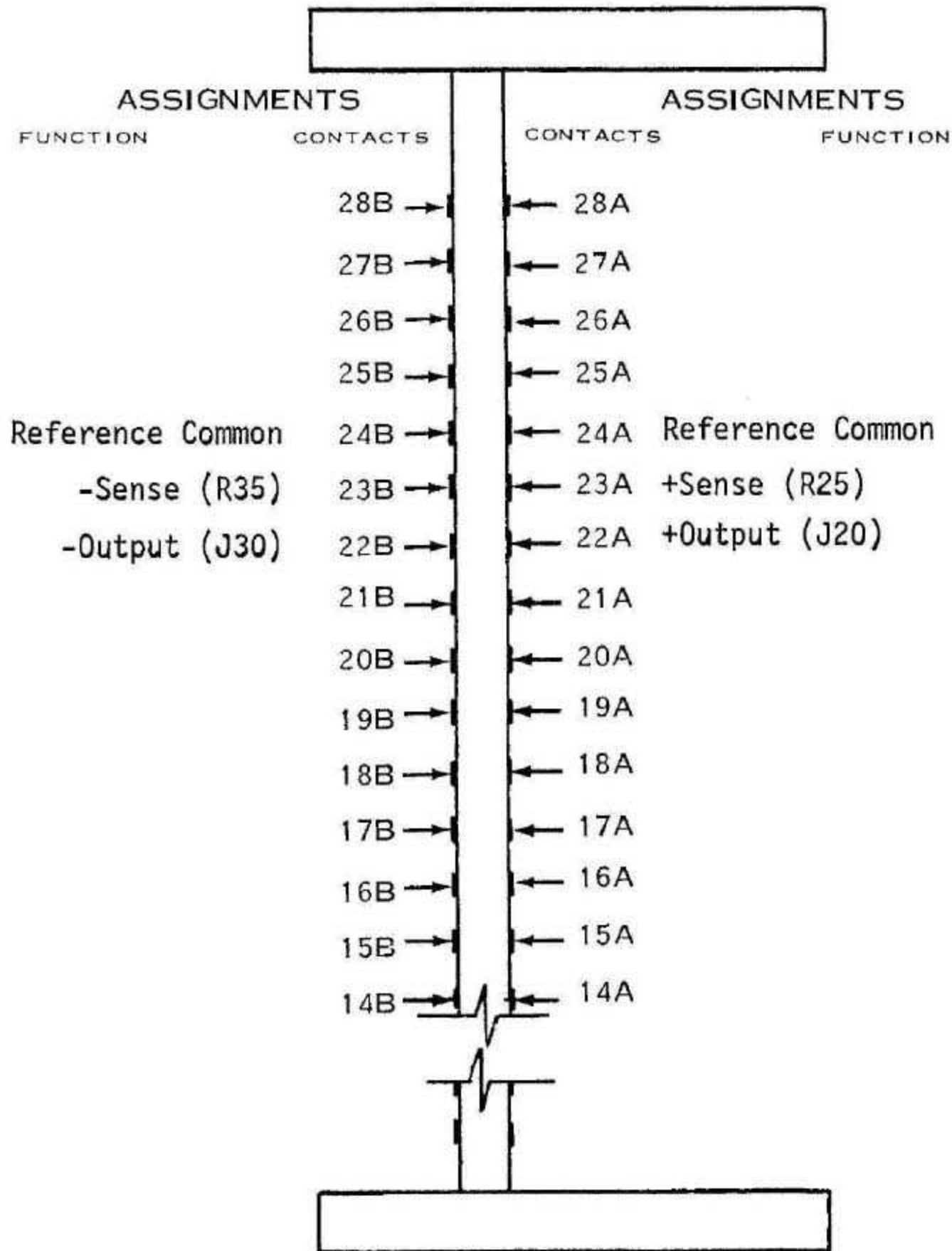

Fig. 2. Unsolder lead to pad "P" to open Sense lead from J50.





## Plug-In or Power Module Rear View

**CAUTION**

*When a Power Module compartment has been selected for the PS 502 and wired for a specialized interface system, a plastic barrier (Tektronix Part Number 214-1593-02) should be installed in the Key Slot between contacts 19 and 20 on the Power Module.*

*Do not insert any TM 500 Series plug-in in a live Power Module and do not use excessive force when inserting the plug-in.*

## Introduction

Remote sensing and remote powering of some load under the Power Module Option 2 capabilities for this instrument may be desirable. Thorough understanding of the schematic diagram and the exact internal connections for Input/Output lines to the rear contacts will be an aid in designing the specialized TM 500 interface system. Figure 1 is designed to help you in this respect.

## Actual Wiring vs. Schematic

The Sense lead should be connected as close to the load as possible to guarantee that the PS 502 lives up to its regulation specifications. Fig. 1 points out the actual difference between wiring detail and the schematic diagram. Two leads actually connect to J20 and two more to J30 on the front panel. If Sensing Input is made at Pins 23A and/or 23B on the interface board, then the Sense connection to J20 and/or J30 must be disconnected to prevent it from being active as well. The output voltage leads that are wire connected to the front panel jacks are well labeled on the "A" (contact 28A) side of the etched circuit board. So, it will be the second lead soldered to the output jacks that is the Sense lead to disconnect.

Reference Common (Both 24A and B). This is the common return for both the + and - voltages offered by this supply. It can be ground referenced for equal and opposite tracking supplies, or it can be allowed to float with the negative supply tied to ground thus giving a single +20 to +40 volt variable supply. Or, the positive supply can also be grounded, thus giving a -20 to -40 volt variable supply. The 25 Vac windings from which this unit operates have no ground reference of their own.

+Sense (R25) and -Sense (R35) (Pins 23A and B, respectively). These are normally high impedance inputs until current limiting starts to take effect. Then, they turn to low impedance inputs, shutting down the supplies and taking the overload currents to the point where diode steering shunts these higher levels of current around the control circuitry.

+Output and -Output (Both 22A and B, respectively). These are the low impedance sources of the two voltages resistance programmed into this unit with respect to the Reference Common connections mentioned above. These voltages will be well regulated up to a maximum load current of 400 mA. Loads that will demand more than 400 mA from these two voltage sources will result in power supply shut down and current limiting.

### NOTE

*The +5 volts with a maximum 1 A current capability is not available at the rear interface connection.*

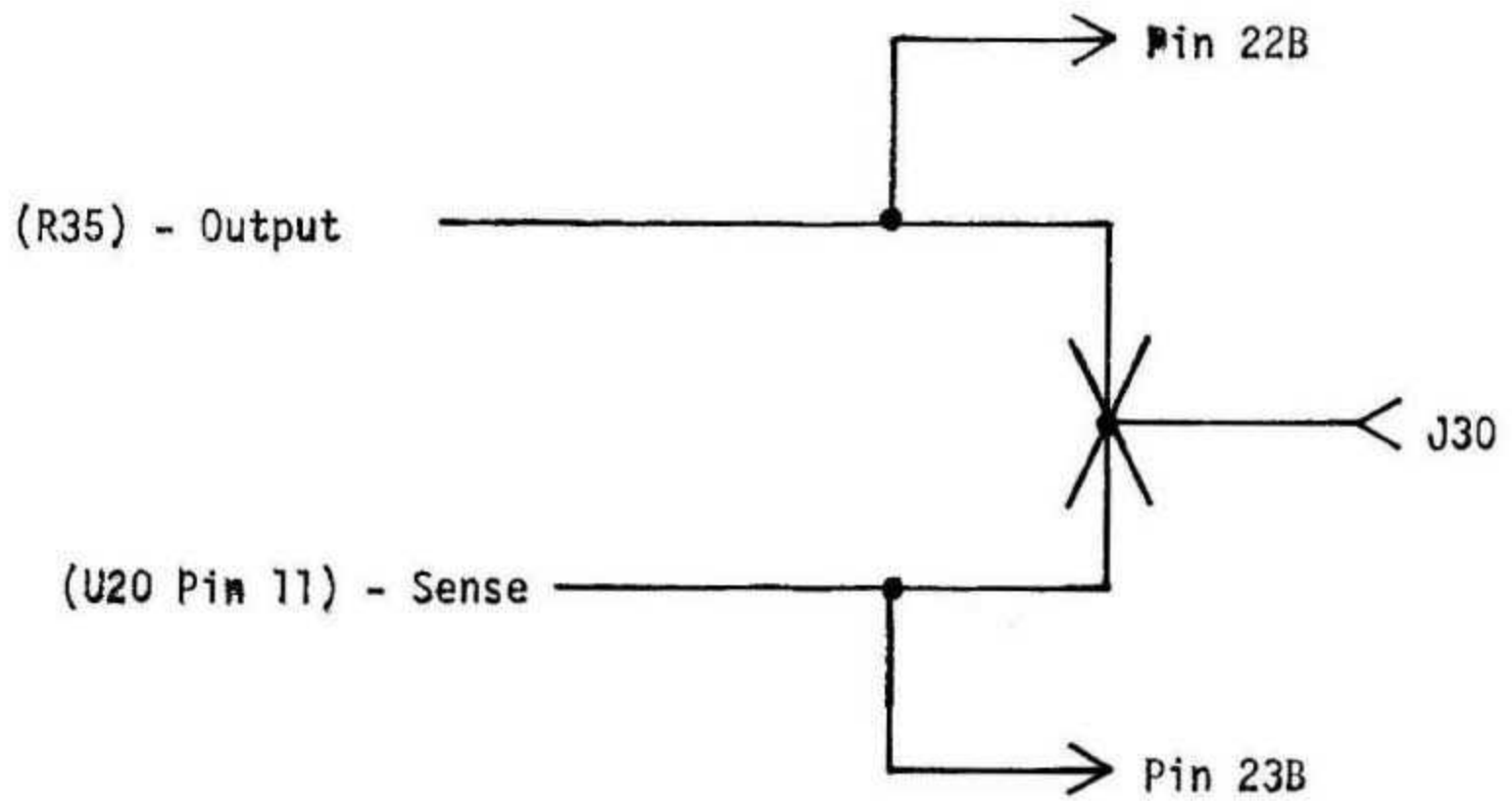
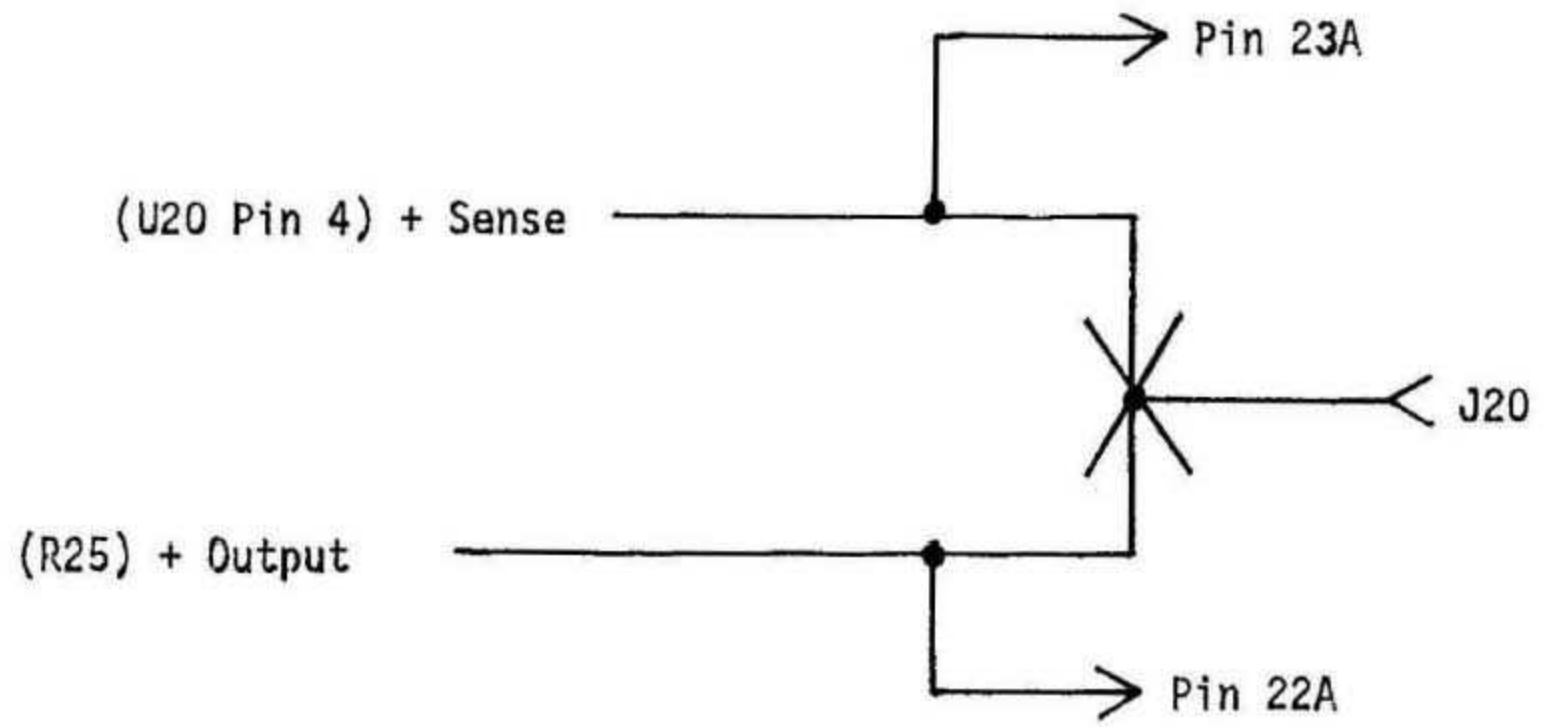





## Plug-In or Power Module Rear View

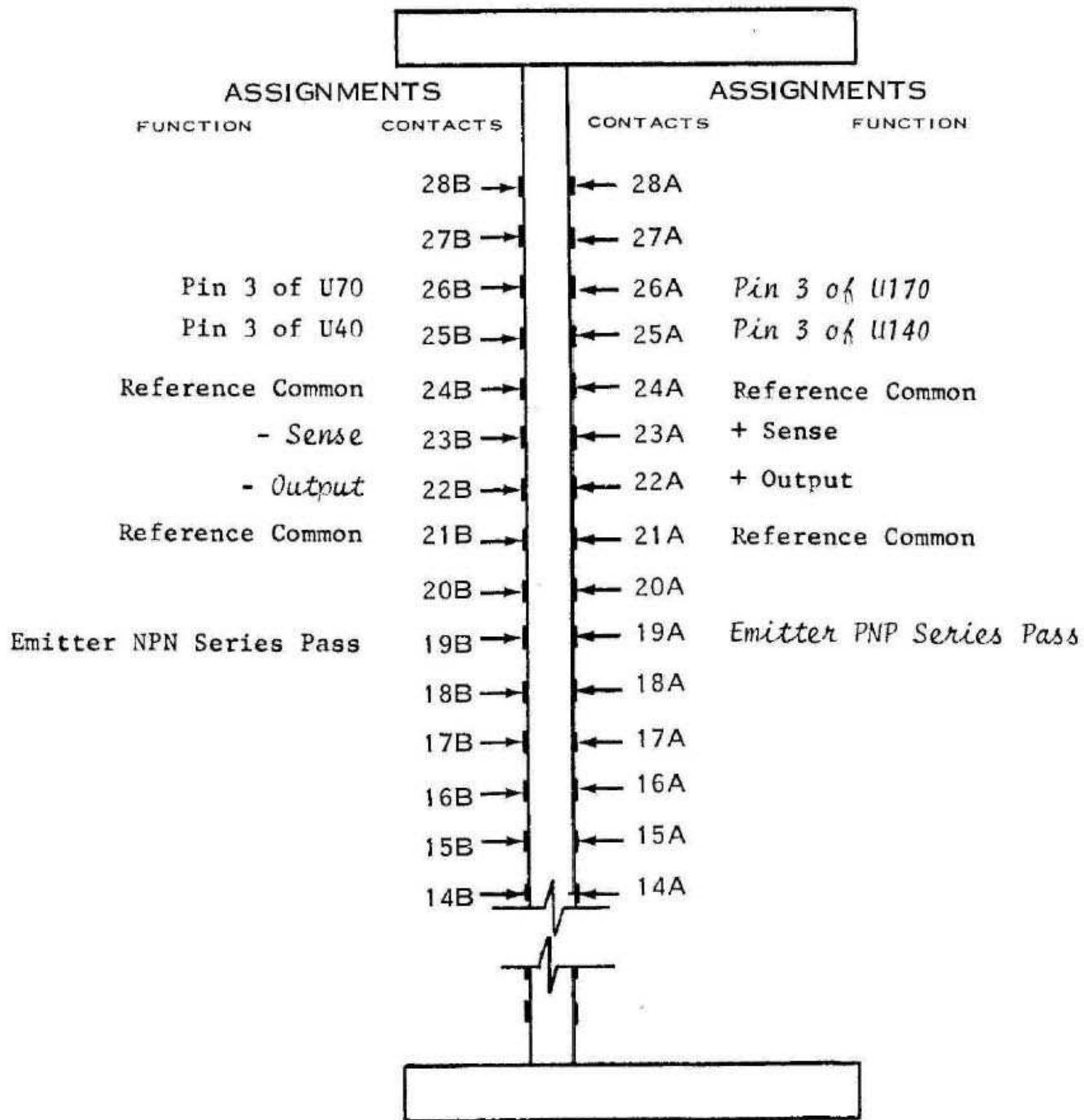

### CAUTION

When a Power Module compartment has been selected for the PS 503 and wired for a specialized interface system, a plastic barrier (Tektronix Part No. 214-1593-02) should be installed in the Key Slot between contacts 19 and 20 on the Power Module.

Do not insert any TM 500 Series plug-in in a live Power Module and do not use excessive force when inserting the plug-in.

## INTERFACE NOTES

## Introduction

Remote programming, powering and sensing of some load under the Power Module Option 2 capabilities of this line of instruments may be desirable. Thorough understanding of the schematic diagram and the exact internal connections for Input/Output lines to the rear contacts will be an aid in designing the specialized TM 500 interface system.

## Detail Circuit Considerations

The PS 503 is a dual zero to twenty volt source of power. One side is a positive supply while the other is a negative supply. The circuitry of the positive supply is almost identical with that for PS 501, while the circuitry for the negative half of this unit is a pnp version of the npn positive half. The control circuitry of the positive supply operates from -5.1 volts and +30.5 volts. The two supplies can be operated independently of each other, or ganged to operate in a Dual Tracking fashion. They share the common return circuitry, thus they are either both ground referenced, both floating or both elevated to the same common level of reference voltage.

The output voltage between J50 and J100 (the + supply) and J150 and J100 (the - supply) is directly set by a gain factor between the Pin 3 inputs of U40 and U140 and the outputs. This gain factor should be approximately 3.23. However, there are parts tolerances within the calibration range of this instrument that can cause further deviations side to side. It will pay you to measure this gain factor for both the + supply and - supply of your specific instrument. To do this, adjust both inputs to an exact +20 volts and -20 volts. Next, measure the voltage on the interface output 25B with respect to 24B (for the + input voltage) and on 25A with respect to 24A (for the - input voltage). The voltage on 25B divided into 20 will be the gain factor for the positive side, while the voltage measured on 25A divided into 20 volts will be the gain factor for the negative side. There is a good possibility they will be slightly different. Do not attempt to make them exactly the same, for the calibration of your unit may be changed as a result.

If external voltages are used to program the output of the PS 503, the wiper arms to R32 and R132 must be disconnected. For the most convenient place to do this, see Fig. 1.

If the output voltages of either or both halves of the PS 503 are taken from the interface connections, remember to disconnect the Sense connection from the front panel outlet. See Fig. 2 for the most convenient place to unsolder this lead. (For proper regulation, voltage sensing must be as close to the actual load as possible.)



## PS 503 I/O Functions and Limitations

Reference Common. Both 24A and 24B as well as 21A and 21B are the common return for both the + voltage and - voltage offered by this supply. It can be ground referenced, elevated or left open. It is suggested that elevation of this point does not exceed a + or - 300 V with respect to ground. These common return leads cannot be separated relative to the + and - supplies due to crossed over interconnections on the etched circuit board, so the two supplies cannot be elevated to two different voltage levels.

Sense (23A and 23B). These are reasonably high impedance inputs (close to 1.6 k $\Omega$ ), even when current limiting takes place. When remote Load Voltage Sensing is connected to this point, be sure to open the front panel voltage sensing circuit at point P and AG (see Fig. 2). Sensing of the voltage at the load gives the best regulation.

+ Output (22A) and - Output (22B). These are the low impedance sources of the voltages developed by this unit as dictated by the gain of the two supplies times their respective input voltages to Pin 3 of both U40 and U140. These output voltages are achieved by either adjusting R32 and R132 (or R30A and B in Dual Tracking Mode of operation), or (after opening the wiper arms to R32 and R132, see Figs. 1 and 2) applying a programming voltage to 25B and 25A via the Power Module interface board. Maximum current available from either supply will not exceed 500 mA. However, current limiting at levels below this can be achieved by setting R69 (for the + supply) and R169 (for the - supply). These two pots are front panel controls.

Pin 3 of U40 (25B) and Pin 3 of U140 (25A). Each of these two inputs has a 10 k $\Omega$  resistor between it and Pin 3 of its respective IC. These Pin 3 inputs to the ICs are high impedance inputs, so voltages applied to 25A and B will show up accurately at the ICs. External programming of the outputs of this unit can be achieved by applying an appropriate voltage to each of these two points, but remember to make sure the wiper arms to R32 and R132 are disconnected (see Figs. 1 and 2). Do not program either of these two outputs for voltages in excess of 20 volts with respect to reference common.

Pin 3 of U70 (26B) and Pin 3 of U170 (26A). Rear interface connection point 26B is an external current limiting control point for the positive supply. If 26B is left open (no connection made to it), current limiting takes place as controlled by the front panel CURRENT LIMIT pot. If it is connected to 19B, the current limiting feature is completely disabled. If fixed at 0.6 volt below REFERENCE COMMON, this supply is shut down and will not operate.

Rear interface connection point 26A is an external current limiting control point for the negative supply. If 26A is left open (no connection made to it), current limiting takes place as controlled by the front panel CURRENT LIMIT pot. If 26A is connected to 19A, the current limiting feature is completely disabled. If it is fixed at 0.6 volt above reference common, this supply is shut down and will not operate.

## NOTE

*The +5 volts with a maximum 1 A current capability is not available at the rear interface connector.*



## Power Supplies—PS 503

Voltage Regulation For Remote Load Critical. Under extremely critical voltage regulation requirements for remotely connected loads to the interface board, it may be desirable to interconnect all four commons (i.e., 21A, 21B, 24A, and 24B) at the interface board and disconnect the four leads that go to J100 at the front panel. Bear in mind that leads from 22A and 22B to their respective loads and back to the four commons should be kept as short as a practical. It is further suggested that when using a PS 503 rear interface for remote sensing, it is good practice to connect a filter capacitor across the load. (Approximately 100  $\mu$ F.) This is to prevent oscillations and spurious signals from occurring.

Output Current Monitoring. If output current monitoring is desirable, connect a voltmeter between rear I/O contacts 19B and 22A (for + supply current or between contacts 19A and 22B (for - supply current). The current limiting outputs are developed between these contacts and the internal 2  $\Omega$  resistors will drop 1 V per 500 mA of load current.

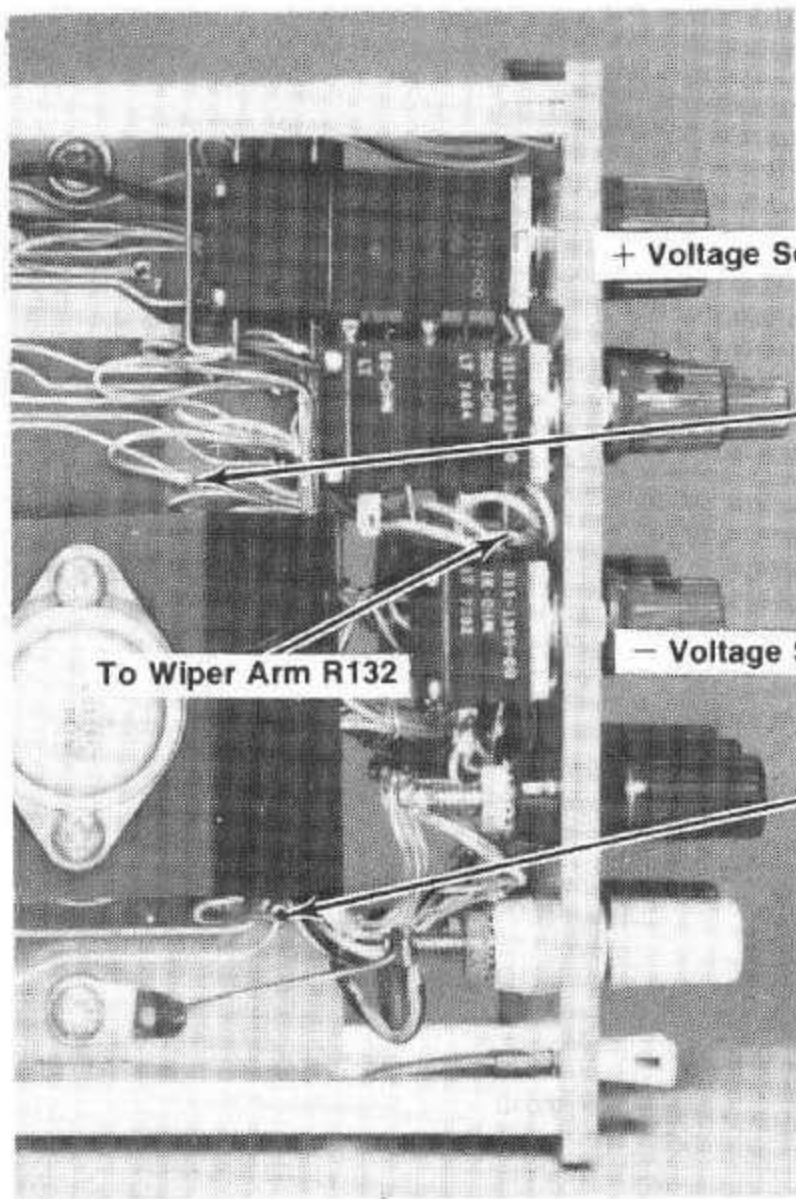

FIG. 1

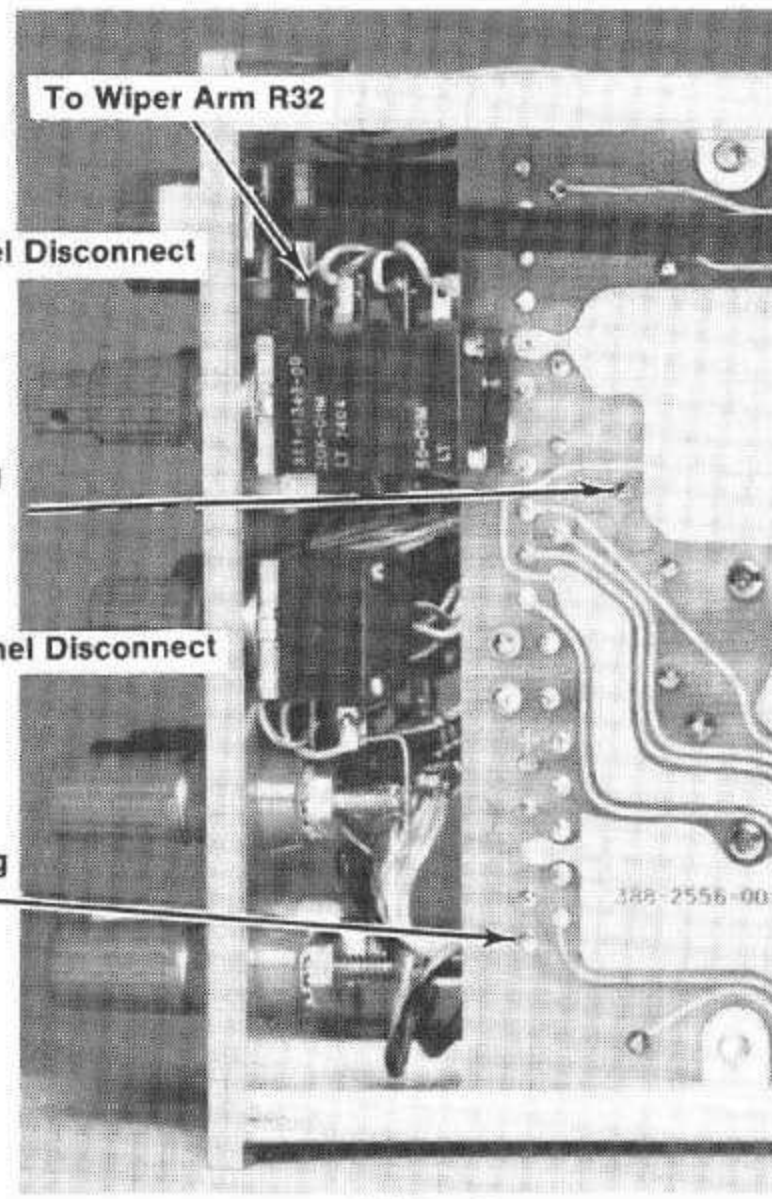
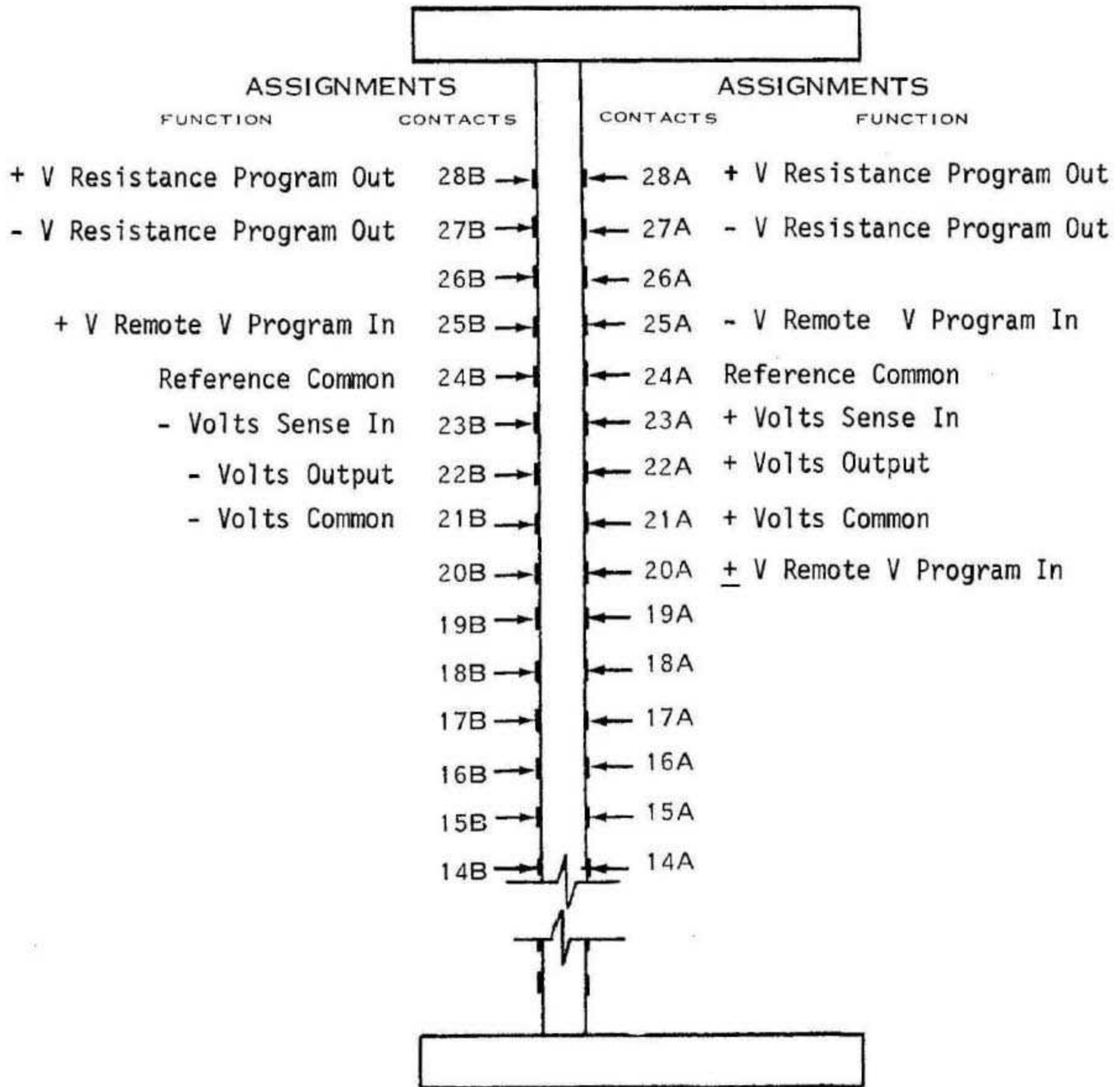

FIG. 2



## Plug-In or Power Module Rear View



**CAUTION**

*When a Power Module compartment has been selected for the PS 503A and wired for a specialized interface system, a plastic barrier (Tektronix Part Number 214-1593-02) should be installed in a key slot between contacts 19 and 20 on the Power Module.*

*Do not insert any TM 500 Series plug-in in a live Power Module and do not use excessive force when inserting the plug-in.*



## INTERFACE NOTES

## Connector Information

+ Volts Resistance Programming Output (Pins 28A and 28B). These two pins are used to remotely resistance program the + voltage output of the PS 503A. Refer to the Function Programming Information. After these pins have been programmed the load is about 500  $\Omega$ /volt of output.

- Volts Resistance Programming Output (Pins 27A and 27B). These two pins are used to remotely resistance program the - voltage output of the PS 503A. Refer to the Function Programming Information. After these pins have been programmed the load is about 500  $\Omega$ / volt of output.

+ Volts Remote Voltage Programming Input (Pin 25B). By connecting a 0 to -9 V remote variable voltage source between Pin 25B and Pin 24A or 24B, the +20 V output may be varied from 0 to 20 V. Refer to the Function Programming Information. The load presented to the remote voltage source is about 5 k $\Omega$ .

- Volts Remote Voltage Programming Input (Pin 25A). By connecting a 0 to 9 V remote variable voltage source between Pin 25A and Pin 24A or 24B, the - 20 V output may be varied from 0 to 20 V. Refer to the Function Programming Information. The load presented to the remote voltage source is about 5 k $\Omega$ .

Reference Common (Pins 24A and 24B). Used as the common return for the + Volts Remote Voltage Programming, - Volts Remote Voltage Programming, + Volts Supply Sense Input and - Volts Supply Sense Input. See Function Programming Information.

- Volts Supply Sense Input (Pin 23B). Used to place the load sensing at the remote load connection. Internal connected sense lead must be disconnected before the interface connections can be used. A large capacitor ( $\geq 50 \mu\text{F}$  at 25 Vdc) will be needed at the sense point to stop oscillations.

+ Volts Supply Sense Input (Pin 23A). Used to place the load sensing at the remote load connection. Internal connected sense lead must be disconnected before the interface connections can be used. A large capacitor ( $\geq 50 \mu\text{F}$  at 25 Vdc) will be needed at the sense point to stop oscillations.

- Volts Supply Output (Pin 22B). This output is in parallel with the front-panel -VOLTS (green) connector. 0 to -20 V at either 0 to 400 mA (plug-in in low power TM 500 Series Power Module compartment) or 0 to 1A (plug-in in high power TM 500 Series Power Module compartment).

+ Volts Supply Output (Pin 22A). This output is in parallel with the front-panel +VOLTS (red) connector. 0 to +20 V at either 0 to 400 mA (plug-in in low power TM 500 Series Power Module compartment) or 0 to 1A (plug-in in high power TM 500 Series Power Module compartment).

- Volts Common (Pin 21B). Common return for the - Volts Supply Output.

+ Volts Common (Pin 21A). Common return for the + Volts Supply Output.

+ Volts Remote Voltage Programming Input (Pin 20A). By connecting a 0 to 9 V remote variable voltage source between Pin 20A and Pin 24A or 24B, the +20 V and -20 V outputs may be varied from 0 to 20 V. Refer to the Function Programming Information. The load presented to the remote voltage source is greater than 5 k $\Omega$ .

## FUNCTION PROGRAMMING INFORMATION

### Remote Resistance Program

Remove the jumpers from F - F (+Volts supply) and H - H (-Volts supply). Install jumpers between E - E (+Volts supply) and G - G (-Volts supply).

Connect a 10.0 k $\Omega$ , 1% resistor between pins 28A and 28B (+Volts supply) and pins 27A and 27B (- Volts supply) on the interface connector. Install the PS 503A into a TM 500 Series Power Module. Connect a digital voltmeter between the +20 volt and common output terminals and between the -20 volt and common output terminals. Adjust R45, +Adj and R145, -Adj to obtain a 20 V reading for each supply or the supply being programmed. Turn off PS 503A and remove the 10.0 k $\Omega$ , 1% resistor.

#### NOTE

*Do not turn on the PS 503A without a program resistor connected between pins 28A and 28B (+ Volts supply) and pins 27A and 27B (- Volts supply) on the interface connector or the over-voltage protection circuit will cause the fuse to blow.*

The PS 503A has now been programmed at 500  $\Omega$ /volt up to 20 V, i.e., a 1 k $\Omega$  change in the program resistor results in a 2 V change in the PS 503A output.

A capacitor connected across the points marked C<sub>f</sub>+ or C<sub>f</sub>- may be needed to stop oscillations caused by the lead length associated with the program resistor.

### Remote Voltage Program

Dual Tracking. Remove the jumper from A - A, then connect a jumper between B - B.

Connect the + lead of the remote voltage to pin 20A and the - lead to pin 24A and 24B on the interface connector. Install the PS 503A into a TM 500 Series Power Module. Connect a digital voltmeter between the +20 V and common output terminals and between the -20 V and common output terminals. Apply 9 V from the remote voltage source to the PS 503A. Adjust R45, +Adj and R145, -Adj to obtain a 20 V reading for each supply.

The PS 503A has now been programmed so that a 9 V remote input voltage results in a 20 V output. By removing C34 and applying a waveform that varies between 0 and +9 V, both + and - supply outputs will follow the input remote voltage source. The slew rate and accuracy when operated this way is dependent on the load and the change in the output voltage.



## Power Supplies—PS 503A

Individual Supply. Remove the jumpers from D - D (+ Volts supply) and K - K (- Volts supply). Install jumpers between C - C (+ Volts supply) and J - J (- Volts supply).

The PS 503A plus and minus supplies can be externally programmed from the plus and minus terminals of a remote voltage source as follows:

PROGRAM + SUPPLY	
REMOTE	PS 503A
+	24A and 24B
-	25B
PROGRAM - SUPPLY	
REMOTE	PS 503A
+	25A
-	24A and 24B

Install the PS 503A into a TM 500 Series Power Module. Connect a digital volt-meter between the +20 V and common output terminals and between the -20 V and common output terminals. Apply 9 V from the remote voltage source to the PS 503A. Adjust R45, +Adj and R145, -Adj to obtain a 20 V reading for each supply or the supply being programmed.

The PS 503A individual supplies have now been programmed so that a 9 V remote input voltage results in a 20 V output. One or both supplies may now be independently swept from 0 to 20 V. The slew rate depends on the load and the change in output voltage.

### Remote Output (Remote sensing)

+ Volts Supply. Remove the + sense wire (blk-red wire) from the post of the red-connector and the + sense common wire (wht-red) from the upper front portion of the circuit board. Insulate the bare end of the wires.

Connect the remote load between pin 21A (+ Volts supply common) and pin 22A (+ Volts supply output) on the interface connector.

Connect interface connector pins 24A and 24B to pin 21A (+ Volts supply common) at the remote load connection.

Connect interface connector pin 23A (+ Volts supply sense input) to pin 22A (+ Volts supply sense output) at the remote load connection.

Install a 50  $\mu$ F, 25 Vdc (minimum rating) capacitor across the remote load. To stop oscillations caused by lead length an additional capacitor may be needed across the point marked Cf+.

- Volts Supply. Remove the - sense wire (blk-vio wire) from the post of the green connector and the - sense common wire (wht-red) from the lower front portion of the circuit board. Insulate the bare ends of the wires.

Connect the remote load between pin 21B (- Volts supply common) and pin 22B (- Volts supply output) on the interface connector.

Connect interface connector pins 24A and 24B to pin 21B (- Volts supply common) at the remote load connection.

Connect interface connector pin 23B (- Volts supply input) to pin 22B (- Volts supply output) at the remote load connection.

Install a 50  $\mu$ F, 25 Vdc (minimum rating) capacitor across the remote load. To stop oscillations caused by lead length, an additional capacitor may be needed across the point marked  $C_f^-$ .

Combined Supplies. Remove the + sense wire (blk-red wire) from the post of the red-connector and the - sense wire (blk-vio wire) from the post of the green connector. Remove from the charcoal gray connector two of the wires. Insulate the bare ends of the wires.

Connect the remote load between pin 22A (+ Volts supply output) and pin 22B (- Volts supply output) on the interface connector.

Connector interface connector pins 24A and 24B to both pin 21A (+ Volts supply common) and pin 21B (- Volts supply common).

Connect interface connector pin 23A (+ Volts supply sense input) to pin 22A (+ Volts supply sense output) and pin 23B (- Volts supply input) to pin 22B (- Volts supply output) at the remote load connections.

Install a 50  $\mu$ F, 25 Vdc (minimum rating) capacitor across the remote load. To stop oscillations caused by lead length, an additional capacitor may be needed across the points marked  $C_f^+$  and  $C_f^-$ .

Dual Operation of + Volts and - Volts Supplies. Remove the + sense wire (blk-red wire) from the post of the red-connector and the - sense wire (blk-vio wire) from the post of the green connector. Remove from the charcoal gray connector two of the wires. Insulate the bare ends of the wires.

Connect the remote load between pin 21A (+ Volts supply common) and pin 22A (+ Volts supply output) and between pin 21B (- Volts supply common) and pin 22B (- Volts supply output) on the interface connector.

Connect interface connector pins 24A and 24B to both pin 21A (+ Volts supply common) and 21B (-Volts supply common) at the remote load connection.

Connect interface connector pin 23A (+ Volts supply sense input) to pin 22A (+ Volts supply sense output) and pin 23B (- Volts supply input) to pin 22B (- Volts supply output) at the remote load connection.

Install a 50  $\mu$ F, 25 Vdc (minimum rating) capacitor across the remote load. To stop oscillations caused by lead length, an additional capacitor may be needed across the points marked  $C_f^+$  and  $C_f^-$ .





## Plug-In or Power Module Rear View

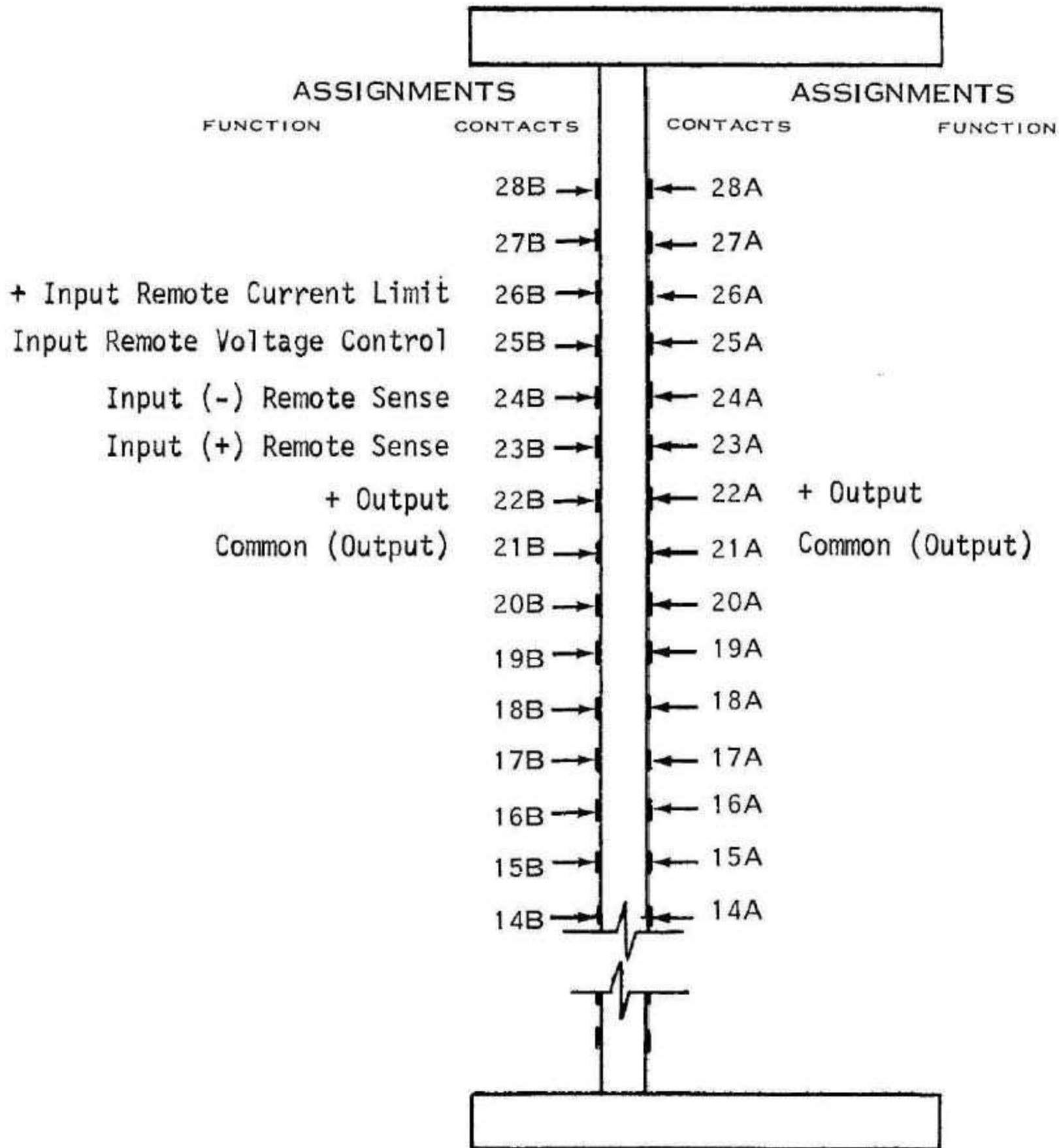

### CAUTION

*When a Power Module compartment has been selected for the PS 505 and wired for a specialized interface system, a plastic barrier (Tektronix Part Number 214-1593-02) should be installed in a key slot between contacts 19 and 20 on the Power Module.*

*Do not insert any TM 500 Series plug-in in a live Power Module and do not use excessive force when inserting the plug-in.*

## INTERFACE NOTES

### NOTE

*The following descriptions apply to PS 505 only if it is installed in the right-hand (high Power) compartment of a TM 504 or TM 506 Power Module.*

#### + Input Remote Current Limit

Applying 0 to 0.4 V between contacts 26B (positive) and 23B (negative) selects a current limit from 0 to at least 4A respectively. To use the remote current limit function, the front-panel CURRENT LIMIT control must be set to its midrange position or wiper connection removed. Parallel capacitors may be needed across the input to stop oscillation. The input resistance is about 5 k $\Omega$ .

#### Input Remote Voltage Control

Connecting a +3 V to +5.5 V between contacts 25B (positive) and 21B (negative) selects an output voltage from +3 V to +5.5 V respectively. The front-panel VOLTS control must be set to 4.25 V before using the remote voltage control function or wiper connection removed. The input resistance for contact 25B is 5 k $\Omega$ .

#### Input (-) Remote Sense and Input (+) Remote Sense

Contacts 24B and 23B are used to place the load sensing at the remote load connections. Remove from the circuit board the wires going from the - and + output terminals to the - and + solder pads. Insulate the bare end of the wires.

Connect the remote load between contacts 22A-22B (+Output) and contacts 21A-21B (Common - Output) on the interface connector. Connect contact 24B (-Sense) to contacts 21A - 21B and contact 23B (+Sense) to contacts 22A - 22B at the remote load connections.

#### + Output

Contacts 22A and 22B are in parallel with the front-panel + Output terminal.

Common (Output) And Input (-) Remote Sense

Contacts 24B (Input - Remote Sense) and 21A - 21B (Common - Output) are floating grounds and are not normally tied to chassis ground because of ground loop problems. Refer to the Operating Instructions section of the PS 505 manual.

NOTE

*If the PS 505 is operated in a compartment other than the right-hand (high power) compartment of a TM 504 or TM 506, the output current drawn from the PS 505 must be limited to 1.0 amperes maximum. However, the negative output terminal should be grounded at the front panel, since there is a possible ground path of uncertain characteristics through the rear connector when the PS 505 is operated in any place other than in the right-hand compartment.*



**SECTION 14**  
**RAMP GENERATORS**



## Plug-In or Power Module Rear View

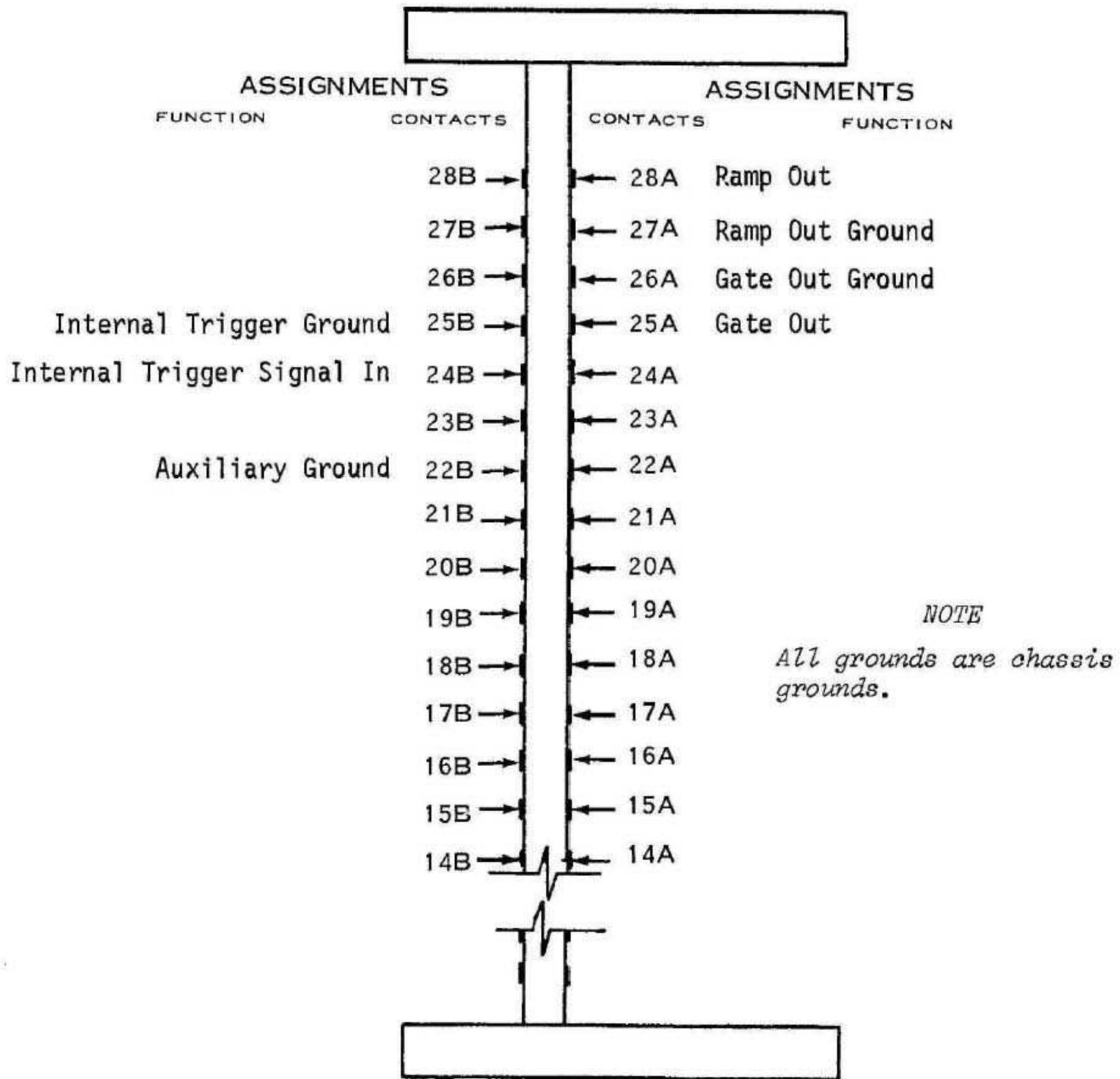

### CAUTION

*When a Power Module compartment has been selected for the RG 501 and wired for a specialized interface system, a plastic barrier (Tektronix Part Number 214-1593-02) should be installed in a key slot between contacts 23 and 24 on the Power Module.*

*Do not insert any TM 500 Series plug-in in a live Power Module and do not use excessive force when inserting the plug-in.*

## INTERFACE NOTES

### Ramp Out (Contact 28A and Ramp Out Ground (Contact 27A)

Pin 28A is connected in parallel (factory wired) with the front panel RAMP OUT bnc connector. Ramp polarity is selected by a front panel POLARITY switch. When properly calibrated, the ramp baselines start at ground level. The output amplitude is variable (by front panel RAMP AMPLITUDE control) from 50 mV or less, to at least 10 V (peak-to-peak). The output circuit is designed to drive a load resistance of 3000 ohms or greater. Maximum load capacity is 300 pF. Use contact 27A as a ground return for the Ramp Out signal.

### Gate Out (Contact 25A) and Gate Out Ground (Contact 26A)

Pin 25A is factory wired in parallel with the front panel GATE OUT bnc connector. Use contact 26A as a ground return. The Gate Out pulse is coincident with the Ramp Out signal. The Gate Out pulse is TTL compatible with the lower level within 100 mV of zero and the upper level at 3 V, within 0.6 V. The loading circuits should be designed to limit the rise and fall times to 100 nanoseconds or less. Source resistance is 160 ohms, within 5%.

### Internal Trigger In (Contacts 24B and 25B)

When triggering signals are applied to contact 24B, push the front panel button labeled INT. This connects pin (contact) 24B to the internal triggering circuitry and disconnects the front panel triggering EXT IN connector and deactivates the LINE triggering feature. Pushing the INT button does not deactivate the AUTO triggering functions. Triggering sensitivity is at least 200 mV (peak-to-peak) with a response from dc to at least 100 kHz. The input impedance is 10 k $\Omega$  (minimum) to 20 k $\Omega$  (maximum). Maximum safe input voltage is 50 V dc plus peak ac. Use contact 25B as a ground return.

### Ground (Contact 22B)

Use contact 22B as an auxiliary ground return to the RG 501 chassis.



# **SECTION 15**

# **OSCILLOSCOPES**



## Plug-In or Power Module Rear View

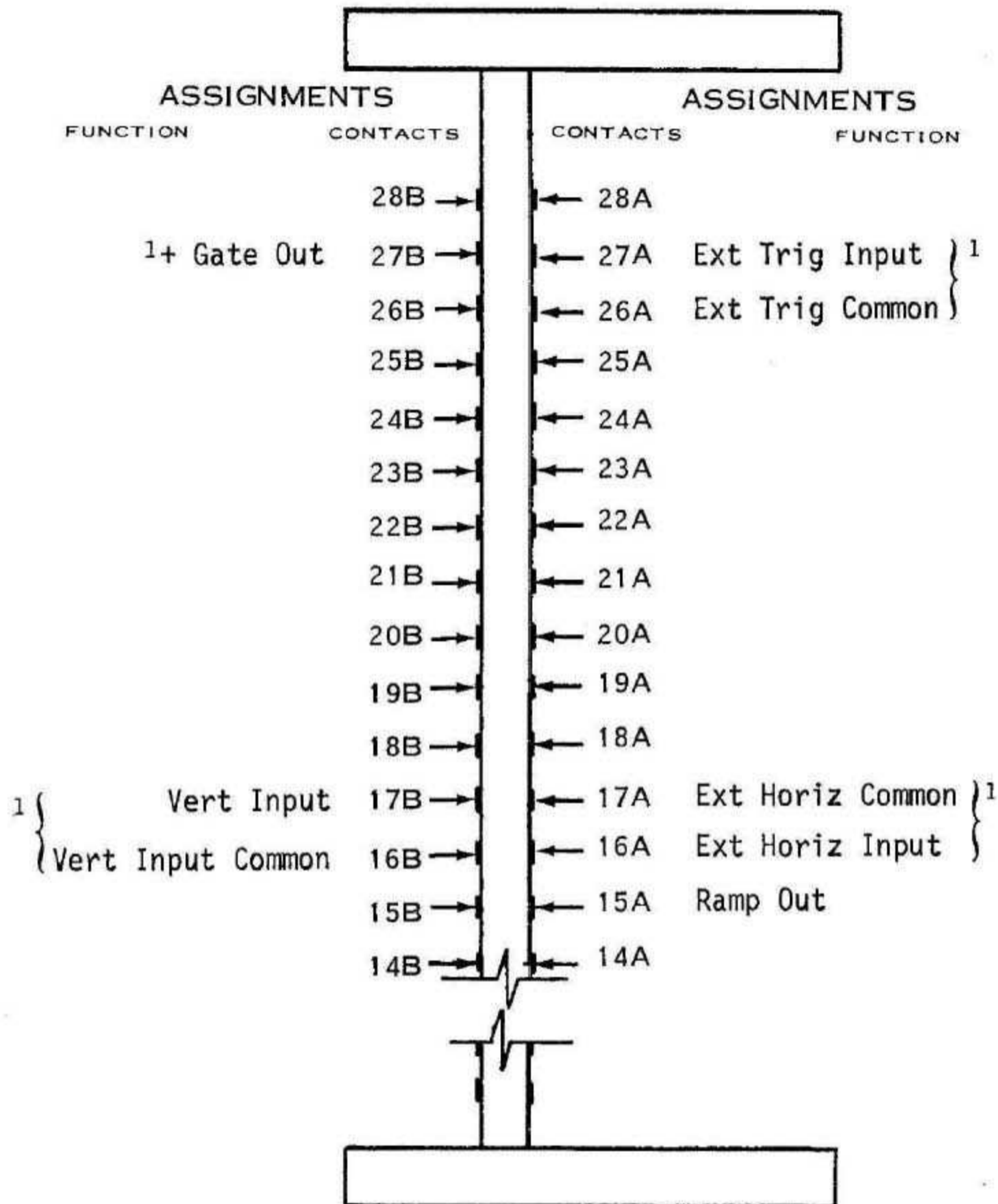

<sup>1</sup> Customer installed wiring required.

## CAUTION

When a Power Module compartment has been selected for the SC 501 and wired for a specialized interface system, a plastic barrier (Tektronix Part No. 214-1593-02) should be installed in a key slot between contacts 23 and 24 on the Power Module.

Do not insert any TM 500 Series plug-in in a live Power Module and do not use excessive force when inserting the plug-in.

## INTERFACE NOTES

## Ramp Out (Contact 15A)

The Ramp Out signal is factory wired (dc coupled) to the rear interface through contact 15A. The output impedance is about 470 ohms (R251). When the SC 501 is properly calibrated and operated in a Y - T mode (internal switch selection), the Ramp Out signal starts at about 0 V and goes positive to at least +10 V (open circuit). Absolute amplitude is load dependent. The Ramp Out duration is dependent on the sweep rate selected (approximately equal to sweep rate X 10 divisions). Time between ramps is dependent on sweep retrace time, sweep hold-off periods, and triggering frequency. Slope (Volts/second) is adjustable by the sweep VARIABLE control. X5 Sweep Magnification factor does not apply to the Ramp Out signal.

For the Y - T mode, contact 15A remains at a quiescent level of 0 V as long as no sweep is generated. When the internal switch is set to the X - Y position, the quiescent level on contact 15A shifts to about +5 V.

## + Gate Out (Contact 27B)

A + Gate Out signal at the junction of R320 (2.2 k $\Omega$ ) and the collector of Q320 can be user-wired via the center conductor of a coaxial cable to contact 27B. Coaxial-cable ground can be any convenient location. The + Gate Out signal is a rectangular pulse whose duration is approximately equal to the crt unblanking interval. Open-circuit output amplitude swings from about +0.2 V to +8 V. Absolute amplitude is load dependent.

## Vert Input (Contacts 17B and 16B)

To apply vertical input signals from the rear interface, connect the center conductor of a miniature coaxial cable to the 200 ohm resistor (R100) attached to the input bnc connector. Connect the other end of the coaxial cable: Center conductor to pin 17B and shield to pin 16B (common). The addition of coaxial cables to input circuits affects the input impedance.

## Ext Trig (Contacts 27A and 26A)

For an Ext Trig signal, connect the center conductor of a miniature coaxial cable to the EXT TRIG pin jack at the front panel. Connect the



other end of the coaxial cable: Center conductor to contact 27A and shield to 26A (common). Set the trigger source switch to the EXT position to trigger the sweep for contact 27A at the rear interface. Input resistance is about 22 k $\Omega$ .

#### Ext Horiz (Contacts 16A and 17A)

To apply external horizontal signals from the rear interface, connect the center conductor of a miniature coaxial cable to the EXT HORIZ pin jack at the front panel. Connect the other end of the coaxial cable: Center conductor to contact 16A and shield to contact 17A (common). Input resistance is about 115 k $\Omega$ . Set the internal switch to the X - Y position.

## Plug-In or Power Module Rear View

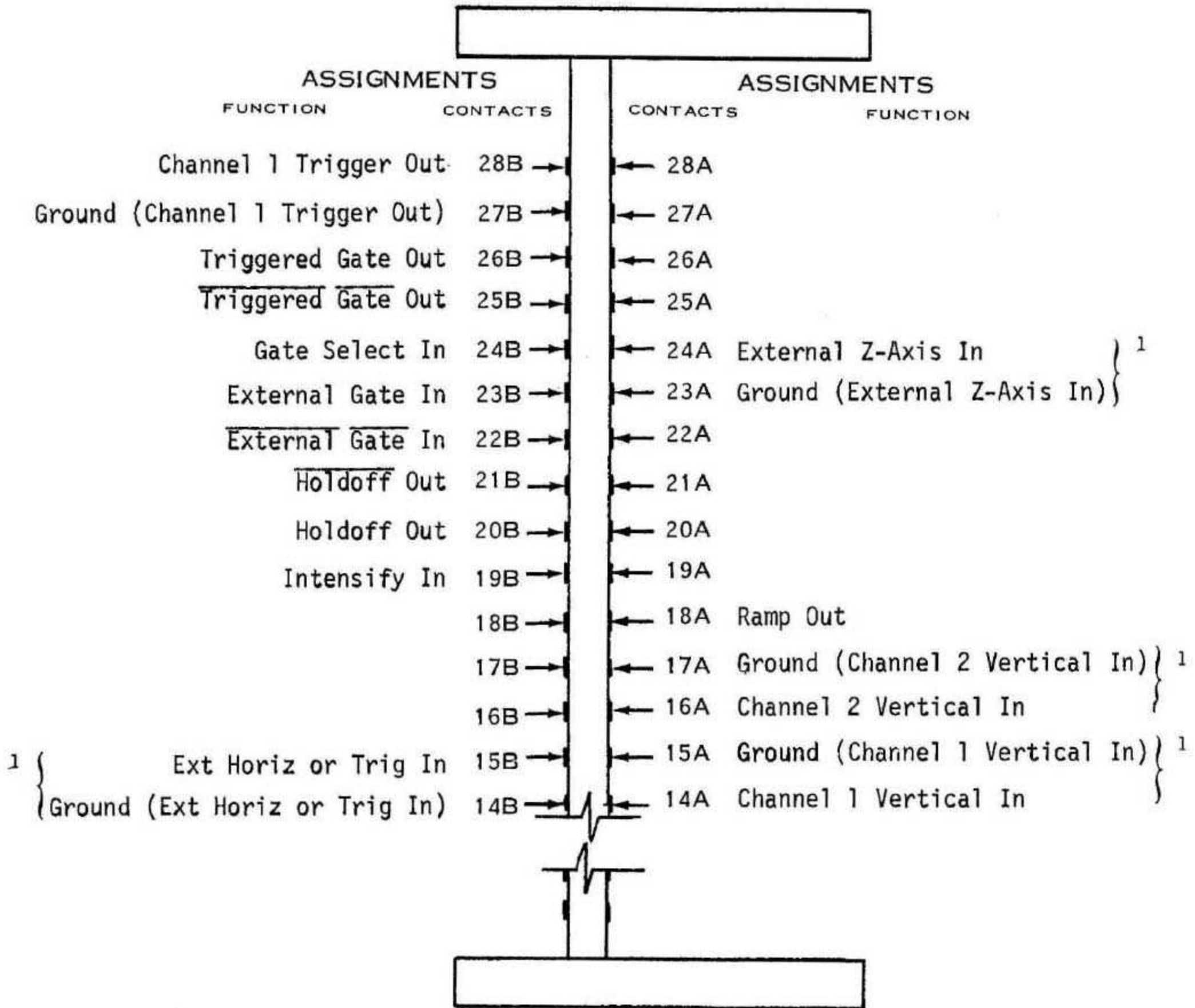

<sup>1</sup> Customer installed wiring required.

### CAUTION

When a Power Module compartment has been selected for the SC 502 and wired for a specialized interface system, a plastic barrier (Tektronix Part No. 214-1593-02) should be installed in the key slot between contacts 25 and 26 on the Power Module.

Do not insert any TM 500 Series plug-in in a live Power Module and do not use excessive force when inserting the plug-in.

## INTERFACE NOTES

## External Z-Axis In

An external Z-axis input signal can be applied to contact 24A (center coaxial conductor) and 23A (ground) to turn the crt beam on or off. This is accomplished by connecting a coaxial cable from the auxiliary Z-axis amplifier solder pads (see Fig. 1) to contacts 24A (center conductor) and 23A (ground). A +5 V signal will unblank the crt beam; a -5 V signal will blank crt beam. The input resistance is 1 k $\Omega$ .

## Ramp Out

Interface contact 18A supplies a 0 to 6.4 V positive going ramp that is coincident with the sweep. The load connected to contact 18A must have an input resistance greater than 100 k $\Omega$ .

## Channel 2 Vertical In

A vertical input signal can be connected to the input of the channel 2 vertical amplifier via interface contact 16A. To do this it is necessary to disconnect, at the circuit board, the coaxial cable going from the front-panel input connector to the circuit board. Connect the appropriate coaxial cable (available through the local Tektronix Field Office) from the channel 2 vertical input circuit board connector to contacts 16A (center coaxial conductor) and 17A (ground). The input resistance is 1 M $\Omega$  and the input capacitance is about 87 pF.

## Channel 1 Trigger Out

Contact 28B furnishes a portion of the channel 1 vertical signal which is also supplied to the trigger circuitry. The signal amplitude is 50 mV/div of crt display amplitude riding a 0 Vdc level. The output resistance is about 100  $\Omega$ ; however, it is recommended that any load connected to contact 28B exceed 10 k $\Omega$ .

Triggered Gate Out and Triggered Gate Out

The signal at contact 26B is a positive-going waveform while the contact 25B signal is negative-going. Both signals are coincident with the gate waveform for sweep generator control. Contact 26B and 25B signals are designed to drive a 100  $\Omega$  side-to-side terminated line with an ECL receiver. The ECL line driver is run between +5 V and ground, and has its outputs to contacts 26B and 25B protected with 47  $\Omega$  resistors.

## Gate Select In

Grounding contact 24B, through 1 k $\Omega$  or less of resistance, blocks the gate waveform from the trigger generator and allows an external gate via contacts 23B and 22B to control the sweep generator.



### External Gate In and $\overline{\text{External Gate In}}$

The input signal to contacts 23B and 22B must drive a 100  $\Omega$  side-to-side terminated line with an ECL receiver. The signal at contact 22B must be a negative-going waveform while the positive-going signal is applied to contact 23B. The ECL receiver is run between +5 V and ground.

### Holdoff Out and $\overline{\text{Holdoff Out}}$

The signal at contact 20B is a positive-going waveform while contact 21B is negative-going. Both signals are coincident with the holdoff signal from the sweep generator. Contact 21B and 20B signals are designed to drive a 100  $\Omega$  side-to-side terminated line with an ECL receiver. The ECL line driver is run between +5 V and ground, and has its outputs to contacts 21B and 20B protected with 47  $\Omega$  resistors.

### Intensify In

The input signal to contact 19B must be the equivalent of an output from an ECL integrated circuit that is run between +5 V and ground. A negative-going signal on contact 19B increases the display intensity. The input resistance of contact 19B is about 1 k $\Omega$ .

### Channel 1 Vertical In

A vertical input signal can be connected to the input of the channel 1 vertical amplifier via interface contact 14A. To do this it is necessary to disconnect, at the circuit board, the coaxial cable going from the front-panel input connector to the circuit board. Connect the appropriate coaxial cable (available through the local Tektronix Field Office) from the channel 1 vertical input circuit board connector to contact 14A (center coaxial conductor) and 15A (ground). The input resistance is 1 M $\Omega$  and the input capacitance is about 87 pF.

### External Horizontal or Trigger In

An external horizontal or external trigger input signal can be connected to the input of the trigger pickoff circuitry via interface contact 15B. This is accomplished by disconnecting, at the circuit board, the coaxial cable going from the front-panel EXT TRIG/AMPL connector to the circuit board. Connect the appropriate coaxial cable (available through the local Tektronix Field Office) from the trigger Pickoff input circuit board connector to contact 15B (center coaxial conductor) and 14B (ground). The input resistance is about 1 M $\Omega$  and the input capacitance is about 47 pF.

Ground (External Z-Axis In, Channel 2 Vertical In, Channel 1 Trigger Out, Channel 1 Vertical In, and External Horizontal or Trigger In)

Contact 27B is electrically tied to the instrument chassis. Contacts 23A, 17A, 15, and 14B are floating. Certain contacts are recommended for specific use for connection convenience.





**SECTION 16**  
**SINE—WAVE GENERATORS**



## Plug-In or Power Module Rear View

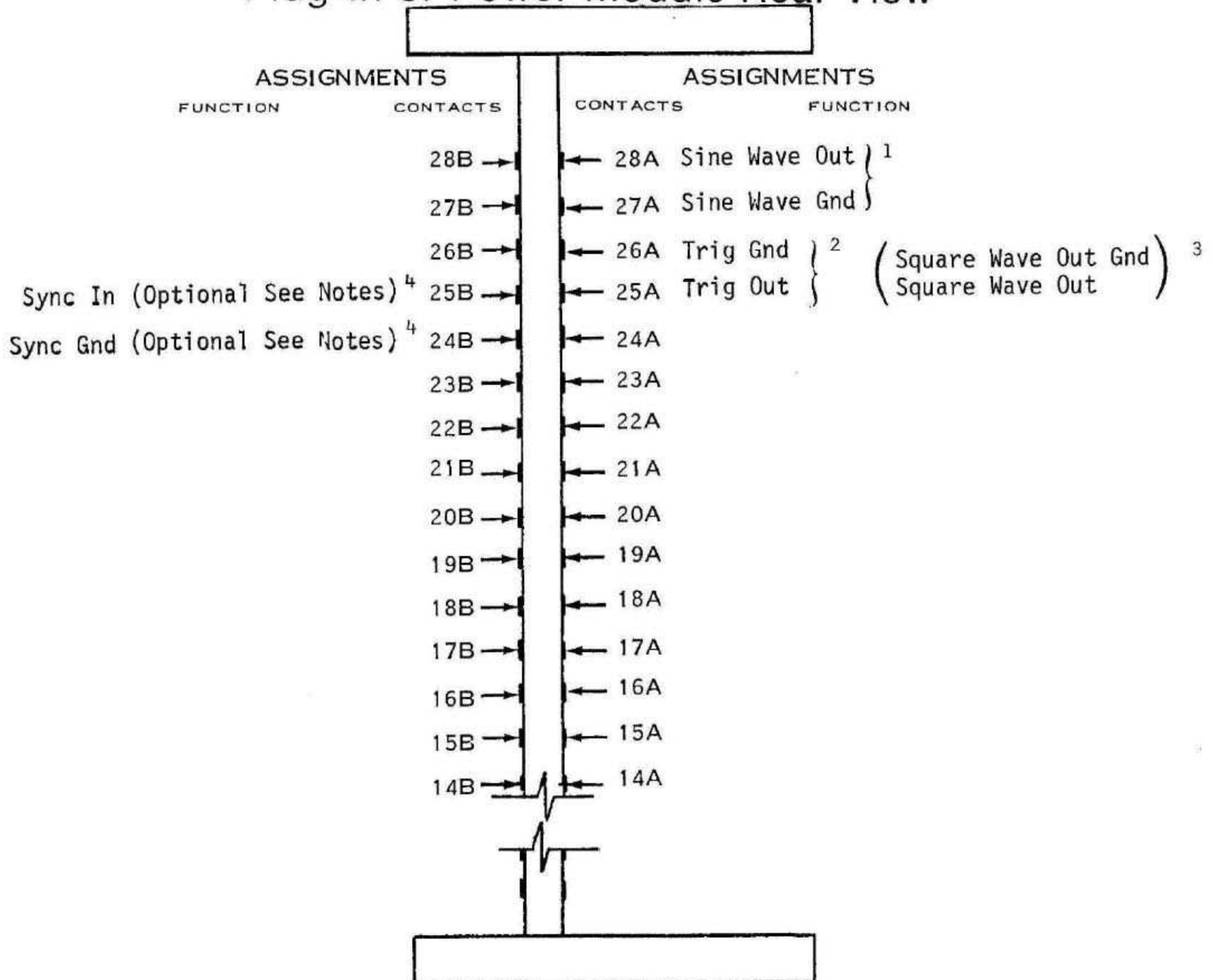

1. Customer installed wiring from SN B010100-B059999. Factory installed wiring from SN B060600-up.
2. Pins 26A and 25A furnish a Trig Out signal from SN B070751-up.
3. From SN B010100 to B069999, pins 26A and 25A furnished a square-wave output signal.
4. The pin assignments shown for sync input in this interface book and the SG 502 instrument manual are 25B sync in (signal input) and 24B sync in (signal ground). Since these connections are not factory-wired, the actual pin assignment can be arbitrary. Other instructions of this same family, such as pulse generators with an external trigger input, use 25B as ground and 24B as the high input. If it is important to maintain compatibility with these instruments, it is suggested that you interchange the assignments for pins 25B and 24B in the diagram and text notes in the SG 502. If compatibility is not important, the assignments shown are satisfactory.

**CAUTION**

When a Power Module compartment has been selected for the SG 502 and wired for a specialized interface system, a plastic barrier (Tektronix Part No. 214-2593-02) should be installed in the key slot between contacts 23 and 24 on the Power Module.

Do not insert any TM 500 Series plug-ins in a live Power Module and do not use excessive force when inserting the plug-in.



## INTERFACE NOTES

### Introduction

For external use, via the interface board connectors of this instrument, you will find a duplication of the sine wave (as available on the front panel) and a special signal for triggering purposes taken from the oscillator amplifier of this unit. User wiring can also supply an extra sync input for controlling the oscillator frequency as suggested in this write-up.

### Detail Circuit Considerations

The operator planning on using the interface connections should understand how this instrument operates. The sine wave signal available at the interface board is a duplicate of that same signal from the bnc connector on the front panel. A piece of coaxial cable is hard wired in at the factory from the back side of the bnc connector to the interface connections in the rear. This may not be evident at first from some of the early manual schematics. These schematics did not show an actual connection between the sine wave bnc connector and the leads that went to the interface connections, however, the hard wiring is there.

In the case of the SG 502, there is also a signal taken from the oscillator to the interface board, which can be used for triggering purposes. This signal is not available on the front panel.

These connections are shown in the Rear Interface Assignments illustration accompanying this article.

Since it might be desirable for the user to insert a controlling sine wave signal at the rear interface rather than through the front panel connector, the following suggestion is offered. A piece of coaxial cable of appropriate impedance (dependent upon the source of signal) can be connected to the input circuitry of C10-R10 as shown in Fig. 1. This coaxial cable should then be fed through the access hole in the shielding surrounding the output circuitry back to the two most convenient connections (i.e., 24B & 25B) at the interface. These two interconnecting points are provided with through-hole-plated solder pads and it's quite easy to make signal connection to 25B and ground connection to 24B from the opposite side of the board as shown in the illustration. See NOTE 4 on previous page.

## SG 502 I/O Functions And Limitations

28A (Sine Wave Out) & 27A (Sine Wave Gnd). Between these two points, you have a  $600\ \Omega$  impedance regardless of the Step Attenuation used (as punched up on the front panel). Considerations with regard to the loading of this source of signal are pointed out in section 1 of the manual. It should be remembered that the interface load will be in parallel with whatever load is present on the front panel bnc connector.

(SN B070751-up) 26A (Trig Gnd) & 25A (Trig Out). This is a fairly low impedance source of signal, somewhere in the neighborhood of about  $1\ \text{k}\Omega$ . Loads less than about  $600\ \Omega$  may require an emitter-follower buffer circuit.

(SN B010100 - B069999) 26A (Square Wave Out Gnd) & 25A (Square Wave Out). A  $600\ \Omega$  impedance exists between these two points. Loading considerations for this signal source are pointed out in section 1 of the instruction manual. It should be remembered that the interface load will be in parallel with any load presented to the front panel bnc connector.

25B (Sync In) & 24B (Sync Gnd). (See note 4.) A high impedance exists between these two points. If the impedance of the signal source matches the coaxial cable installed here, terminate this line at the C10/R10 end for signal purity. There is adequate room to install your terminating resistor between the input end of C10 and the ground mounting point for the shield plate pointed out in Fig. 1. For the signal voltage requirements here, see section 1 of the manual.

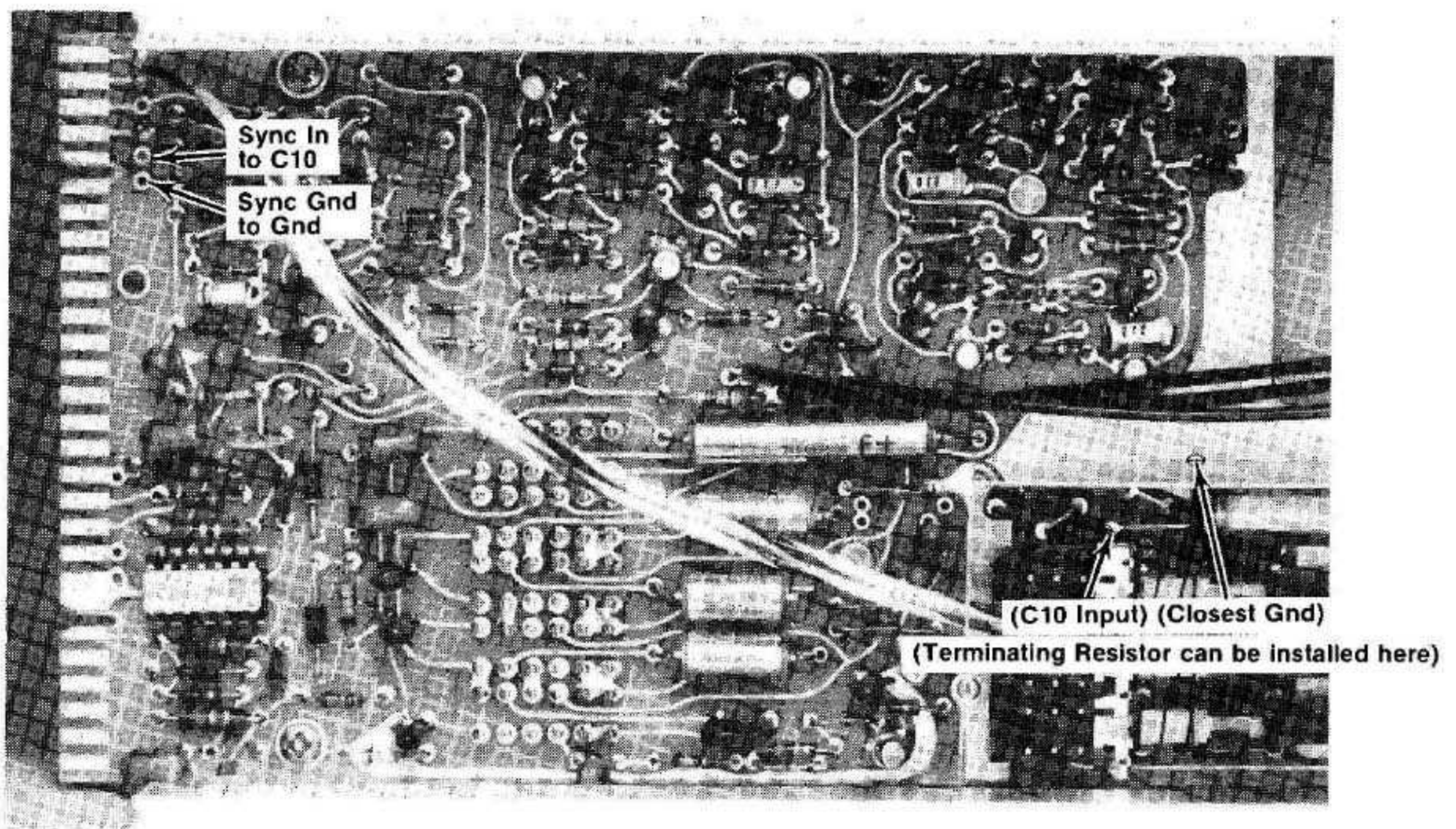
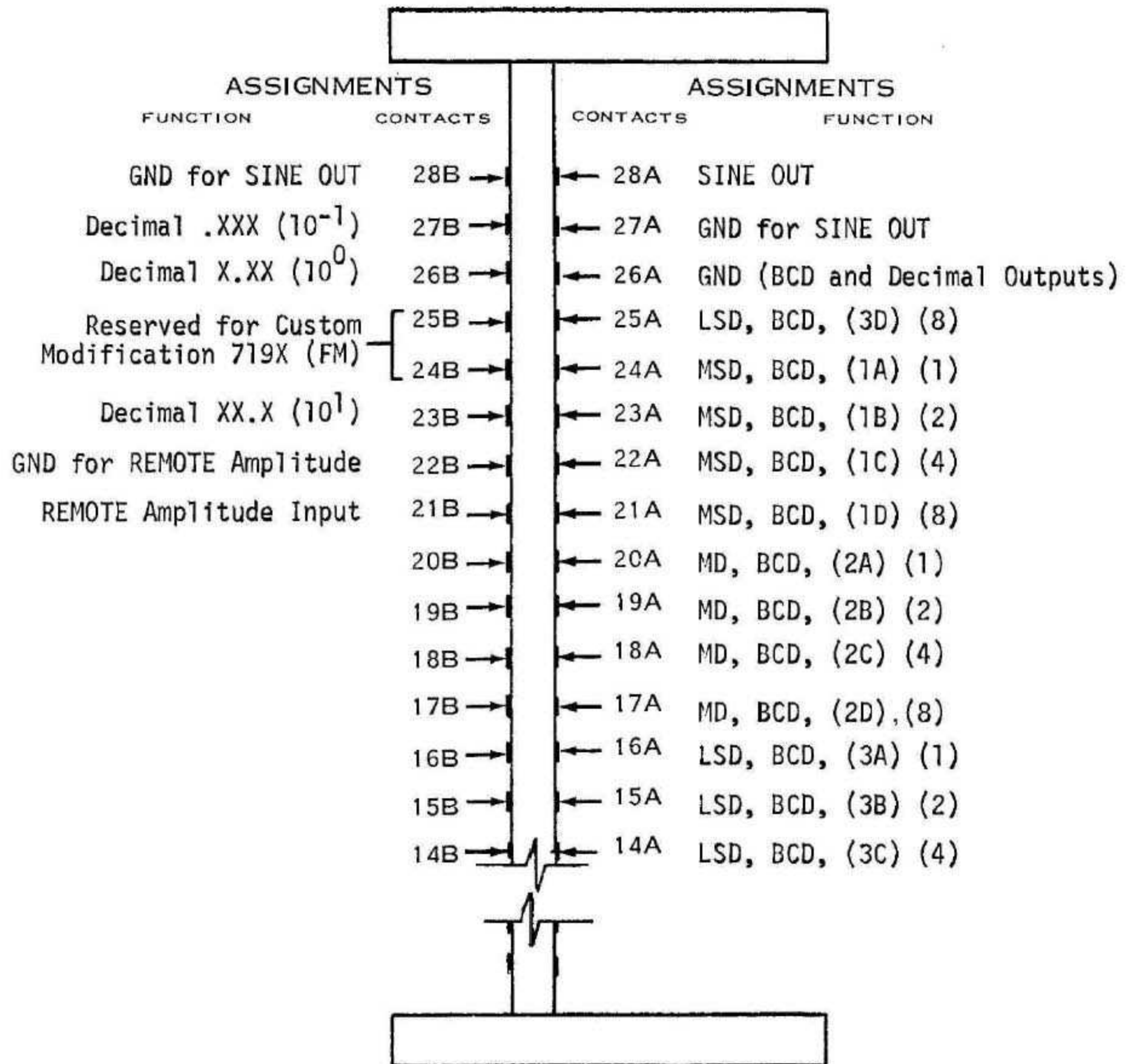

FIG. 1





## Plug-In or Power Module Rear View



NOTE: Pin 26A is the only rear connector pin that is factory wired to internal circuitry. All other inputs and outputs through the rear interface require customer wiring.

## CAUTION

When a Power Module compartment has been selected for the SG 503 and wired for a specialized interface system, a plastic barrier (Tektronix Part No. 214-1593-02) should be installed in a key slot between contacts 23 and 24 on the Power Module.

Do not insert any TM 500 Series plug-in in a live Power Module and do not use excessive force when inserting the plug-in.



## INTERFACE NOTES

### General

Pin 26A is the only rear connector pin (from 14 through 28) that is factory wired to internal circuitry. All other inputs and outputs through the rear interface must be user wired when it is desired to interface the SG 503 in a specialized Option 2 Power Module system.

SINE OUT (contact 28A) and GND for SINE OUT (contacts 27A and 28B).

#### NOTE

*Flatness specifications for the SG 503 are invalid when the output signal has been transferred from the front panel to the rear interface, because the insertion loss between the output and the 50 ohm load will be different from that of the precision coaxial cable (Tektronix Part Number 012-0482-00) provided with the instrument.*

To transfer the output signal from the front panel to the rear interface, perform the following steps;

- (1) Remove the short blue cable (with ferrite bead) between the bnc output connector and the Attenuator-Output Buffer Circuit Board (located on the "B" side of the instrument). When this short blue cable is removed, be certain that it is stored in a known location and not misplaced or lost. This cable is mandatory for repairing or recalibrating the instrument.
- (2) Locate the four holes near pins 27 and 28 on the "B" side of the Main Circuit Board. Install a pin connector socket (Tektronix Part Number 136-0252-01) in the center hole labeled SINE OUT and solder it in place from the "A" side of the board so that connection is made to pin 28A. Install a 3-prong, coaxial-cable receptacle (Tektronix Part Number 131-1003-00) in the remaining three holes and solder it in place from the "A" side of the board so that ground connections are made to pins 27A and 28B.
- (3) Install a 9.4 inch miniature coaxial cable (blue), with connectors on each end (Tektronix Part Number 175-1554-00), from the output connector on the Attenuator-Output Buffer Circuit Board to the newly installed receptacle for SINE OUT. Dress the blue coaxial cable underneath the lower rear corner of the Attenuator-Output Buffer Circuit Board. Be certain that the center conductor of the blue coaxial cable mates with the center socket pins at each end.

- (4) Place a tag to the left of the OUTPUT connector on the front panel, labeled: OUTPUT AT REAR CONNECTOR PIN 28A.

NOTE

*To prevent ground loop currents, GND for SINE OUT (pins 27A and 28B) should not be tied to any other grounds at the rear interface.*

REMOTE Amplitude Controls (Contacts 21B and 22B)

To transfer the OUTPUT AMPLITUDE control from the front panel to the rear interface, perform the following steps:

- (1) On the "A" side of the Main Circuit Board, immediately behind the front panel, locate the unused holes labeled REMOTE. Install a pin connector socket (Tektronix Part Number 136-0252-01) in the center hole, and a 3-prong, coaxial-cable receptacle (Tektronix Part Number 131-1003-00) in the remaining holes and solder in place from the "B" side of the instrument.
- (2) Locate the unused holes labeled REMOTE near rear connector pins 21 and 22 ("A" side, Main Circuit Board). Install a pin connector socket (Tektronix Part Number 136-0252-01) in the center hole, and a 3-prong, coaxial-cable receptacle (Tektronix Part Number 131-1003-00) in the remaining three holes and solder in place from the "B" side of the instrument. Be certain that the center pin socket is connected to pin 21B and that the 3-prong receptacle is providing a ground connection to pin 22B.
- (3) On the "B" side of the Main Circuit Board, locate W260 (Terminal Link). W260 looks like a solid white dummy resistor and is located immediately behind the front panel. Unsolder both ends of W260 and without bending the leads, move it horizontally to the two unused holes about one-fourth inch closer to the front panel. Resolder W260 (from the "B" side) into the new holes.
- (4) On the "B" side of the Main Circuit Board add (solder) a resistor; 51 k $\Omega$ , 1/4 W, 5%, (Tektronix Part Number 315-0513-00) between the circuit board run connected to pin 21B and the unused hole labeled GND.
- (5) Install a 12.4 inch miniature coaxial cable (white), with connectors on each end (Tektronix Part Number 175-1555-00),

between the two newly installed REMOTE receptacles, making sure that the center conductor mates with the center pin sockets at each end. Dress the white coaxial cable between the Coil Circuit Board and the bottom side rail. Do not dress the white coaxial cable along the top side rail. In some instruments, this operation may require loosening screws for the Main Circuit Board and side mount bracket (used as a heat sink); if so, remember to retighten all loosened screws.

- (6) Check with an ohmmeter to verify that a complete circuit (zero resistance) exists between rear connector pin 21B and pin 4 of P230. P230 is the flat blue plug attached to the Attenuator-Output Buffer Circuit Board on the "B" side of the instrument. Pin 4 is connected to a yellow coded wire. Refer to schematic number 1 in the SG 503 instruction manual.
- (7) Place a tag above the OUTPUT AMPLITUDE control on the front panel, labeled: OUTPUT AMPLITUDE REMOTE CONTROLLED AT REAR CONNECTOR PIN 21B.

NOTE

*A dc voltage of approximately -1 V to -11 V applied to pin 21B (after modification) will control the output amplitude over the range from 0.5 V to 5.5 V (peak-to-peak). GND for REMOTE (pin 22B) should not be tied to any other ground at the rear interface.*

BCD Outputs (Contacts 14A through 26A)

The SG 503 can be user wired to provide this type of output data to the rear interface. Each decimal digit displayed on the front panel has its own 4-bit BCD data available from the counters in the form of unused holes (solder pads) on the "A" side of the Main Circuit Board (between the upper two rows of IC's). Each set of four holes are labeled: 1A through 1D for the Most Significant Digit (MSD), 2A through 2D for the Middle Digit (MD), and 3A through 3D for the Least Significant Digit (LSD). The rear connector pins (14A through 25A) are also labeled in a one-to-one correspondence with 1A through 3D. It is only necessary to use flat ribbon-wire cable (Tektronix Part Number 175-0827-00) of the proper length to interconnect the counter BCD outputs to the proper solder pads (holes) for the rear connector pins. Solder all connections from the "B" side of the instrument.



The BCD output data uses positive logic and is TTL compatible. The 4-bit data lines have a fanout of 8. External decoding circuitry depends on the desired application. Pin 26A provides an internal ground for the BCD output data.

#### Decimal Data Output (Contacts 27B, 26B, and 23B)

To transfer Decimal Data to the rear interface, perform the following steps;

- (1) On the "A" side of the Main Circuit Board, just below U480, locate three unused holes (solder pads) labeled:  $10^{-1}$ ,  $10^1$ , and  $10^0$ .
- (2) Use flat ribbon-wire cable (Tektronix Part Number 175-0827-00) to interconnect these pads in a one-to-one correspondence with rear connector solder pads labeled  $10^{-1}$ ,  $10^1$ , and  $10^0$  (just to the left of CR680 and close to rear connector pins 25 and 26). Solder the wire connections on the "B" side of the Main Circuit Board.

Each Decimal Data line will drive only one TTL gate without external buffering. A Decimal Data line goes to an active-high state when the corresponding front-panel decimal point is turned on by the auto-ranging circuitry.



# **SECTION 17**

## **SWEEP GENERATOR**



## Plug-In or Power Module Rear View

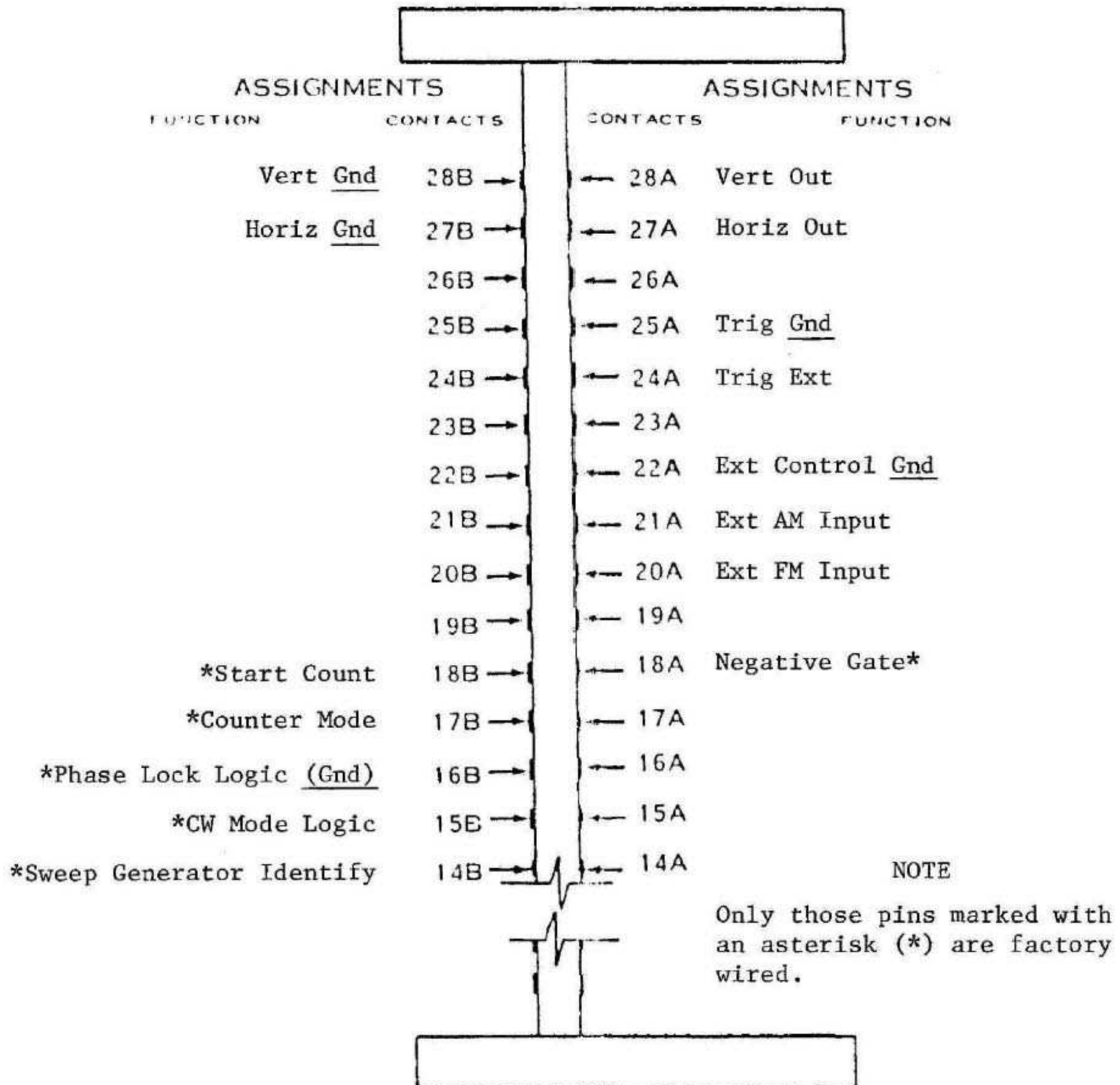

## CAUTION

When a Power Module compartment has been selected for the SW 503 and wired for a specialized interface system, a plastic barrier (Tektronix Part Number 214-1593-02) should be installed in the key slot between contacts 23 and 24 on the Power Module.

Do not insert any TM 500 Series plug-in in a live Power Module and do not use excessive force when inserting the plug-in.

## INTERFACE NOTES

### Dot Marker Interface

Contacts 14B through 18B and 18A are factory wired to interface with the DC 502 Option 7. The dot marker scheme utilizes 6 interconnecting lines between the sweeper and counter. All lines use standard TTL (0 and +5 V) voltages. Four of the lines (14B, 15B, 16B, & 17B) are control lines to preset counter functions and identify that the counter and sweeper are plugged into the Power Module. The remaining two lines (18B and 18A) trigger the counter to start count and signal the end of count. (See Fig. 1)

Other counters could be modified by the user to work with the dot marker scheme. Only two of the lines are required, the start count (18B) to trigger the counter, and the negative gate (18A) from the counter to resume the sweep. In addition, contact 16B would have to be grounded on the sweep generator.

### Suggested Connections For Other Inputs And Outputs:

#### Vert Output (Y) (28A)

The vertical output signal can be applied to contact 28A by connecting a jumper wire from the front panel VERT connector. Vertical output voltage will vary depending upon the type of detector used, but will typically be less than +5 V.

#### Horiz Output (X) (27A)

The horizontal output signal can be applied to contact 27A by connecting a jumper wire from the front panel HORIZ connector. Output voltage will be 500 mV (50 mV/DIV). If desired, an output voltage of 10 V is available from the same point by lifting one end of the 1 k resistor connected to the front panel HORIZ OUTPUT connector.

#### Trig (EXT) (24A)

The external trigger can be enabled from the rear interface by connecting a jumper wire from the front panel TRIG jack to contact 24A. A positive-going pulse of +4 to +10 V is required to remotely trigger the instrument.



## AM (EXT) (21A)

The external AM input can be enabled from the rear interface by connecting a jumper wire from the front panel AMPL jack to contact 21A. The identical functions will be available through the rear interface as through the front panel connections.

## FM (EXT) (20A)

The external FM input can be enabled from the rear interface by connecting a jumper wire from the front panel FREQ jack to contact 20A. The identical functions will be available through the rear interface as through the front panel connections.

## Common Ground (For Vert, Horiz, Trig, AM, and FM)

Eyelets are provided for GND connections adjacent to all rear interface connectors. The contacts (22A, 25A, 27B, and 28B) should be tied to contact 16B if they are to be used.

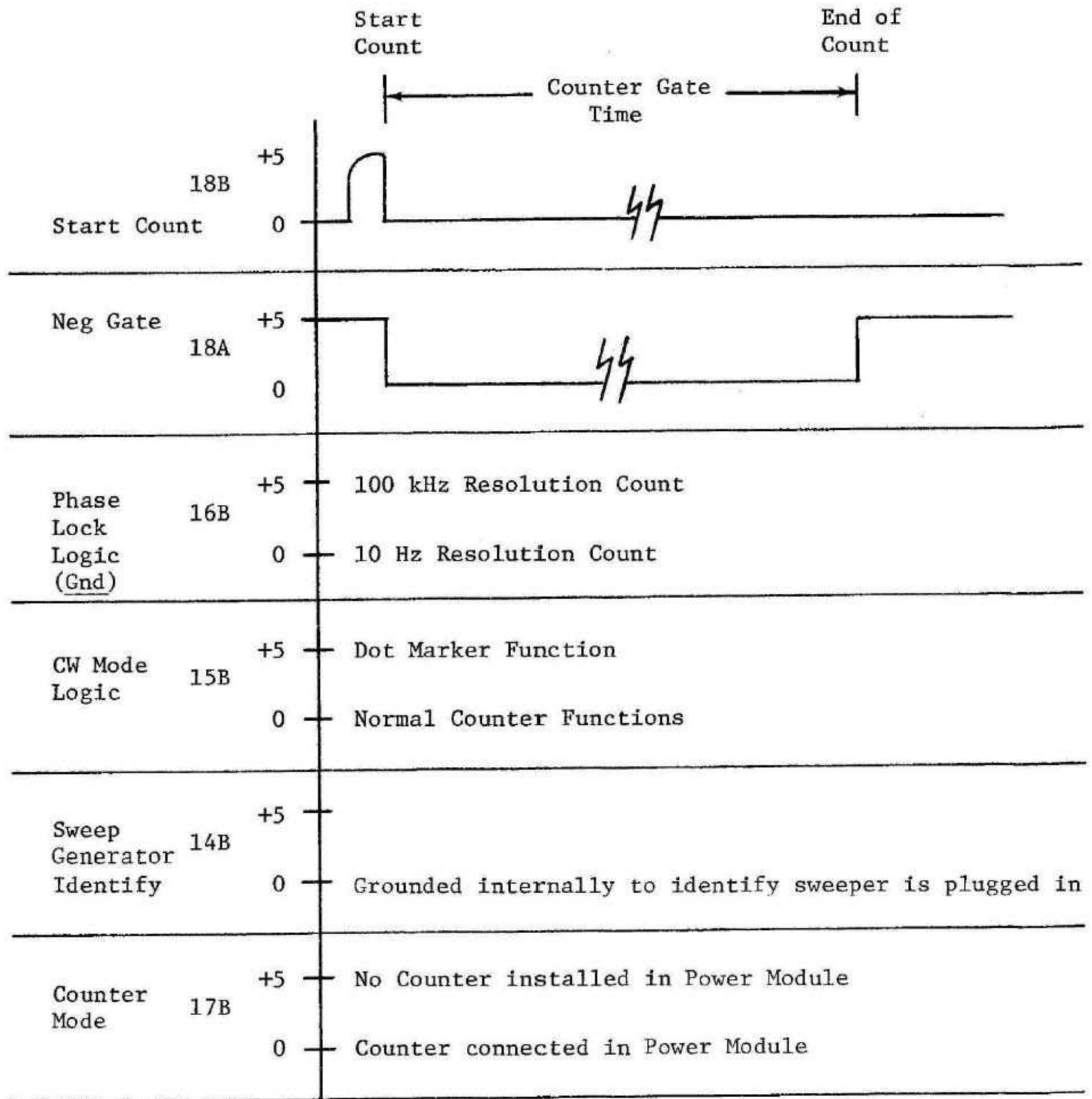
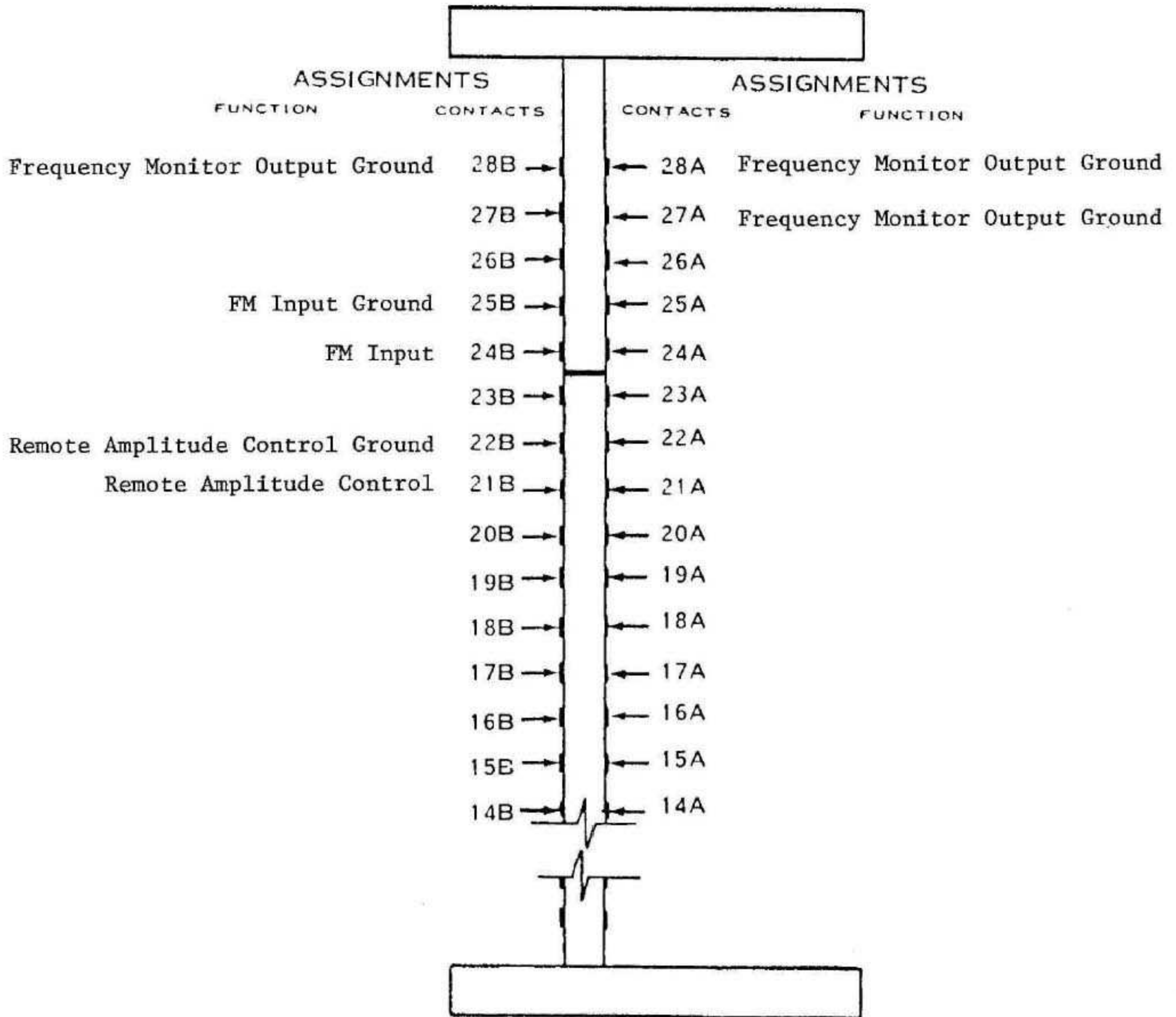

Fig. 1

## Plug-In or Power Module Rear View

**CAUTION**

*When a Power Module compartment has been selected for the SG 504 and wired for a specialized interface system, a plastic barrier (Tektronix Part Number 214-1593-02) should be installed in the key slot between contacts 23 and 24 on the Power Module.*

*Do not insert any TM 500 Series plug-in in a live Power Module and do not use excessive force when inserting the plug-in.*

## INTERFACE NOTES

### Frequency Monitor Output

To use this feature, through the rear interface connector, remove the coaxial plug from the rear of the FREQUENCY MONITOR OUT connector by pulling. Re-connect the free end of the cable to the connector marked Freq Mon as shown on the Adjustment Location Illustration.

### FM Input

To use this feature, remove the coaxial plug from the rear of the FM INPUT connector by pulling. Re-connect the free end of the cable to the connector marked Ext Fm as shown on the Adjustment Location Illustration.

### Remote Amplitude Control

This feature allows external amplitude control of the output signal through the rear interface connector. To use this feature remove the upper end of the jumper marked W265 from the circuit board located as shown on the Adjustment Location Illustration. Connect a wire from the Adjustment Location Illustration. Connect a wire from the vacant hole on the circuit board to the top hole of the double hole pair marked Remote on the rear of the circuit board. Finally install a 51 k $\Omega$ ,  $\frac{1}{4}$  W, 5% resistor from the bottom hole of the pair to the hole below the word Remote.

The voltage range at pin 21 B for full amplitude control of the output signal is -1 V to -11 V maximum. -1 V provides minimum output amplitude while -11 V provides maximum output amplitude. Do not exceed -11 V.



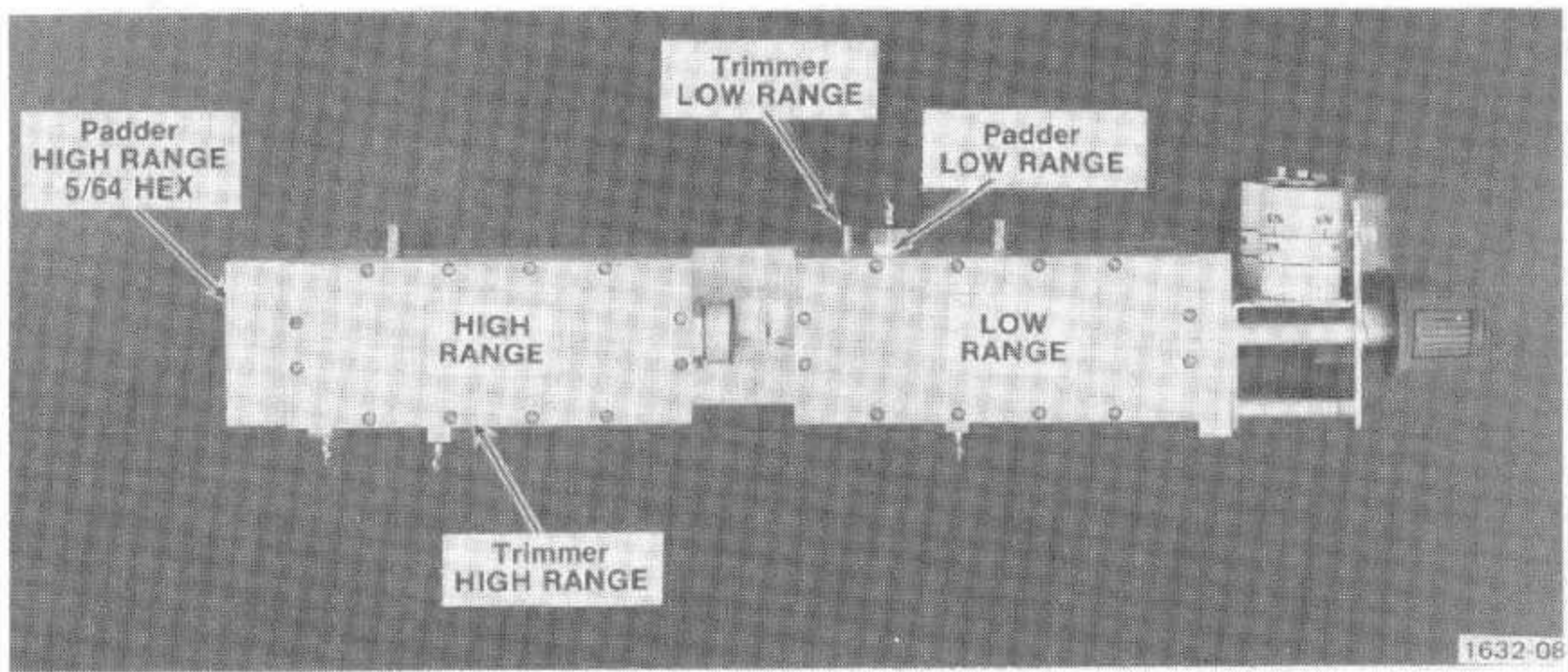
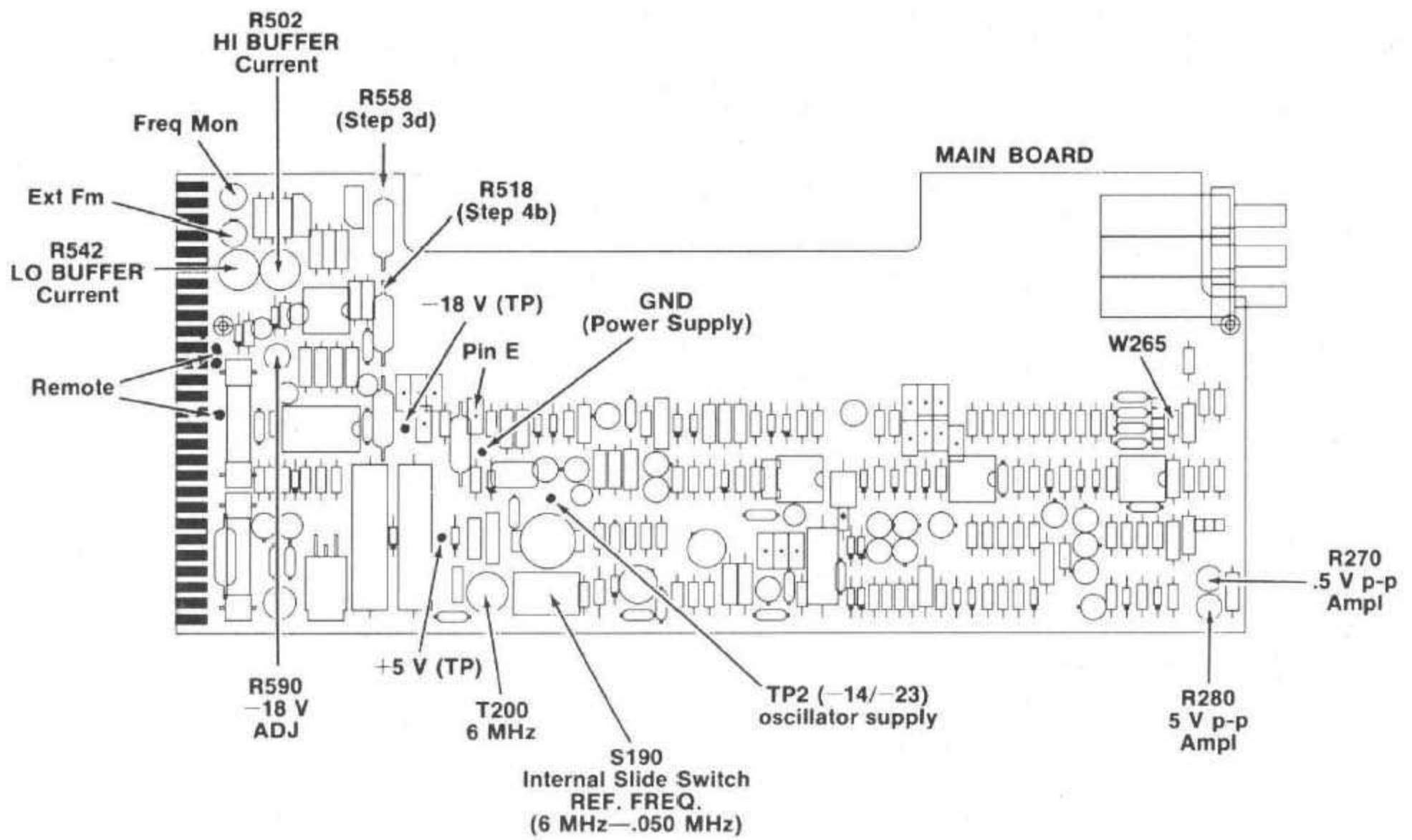

**SECTION 18**  
**TIME-MARK GENERATORS**



## Plug-In or Power Module Rear View

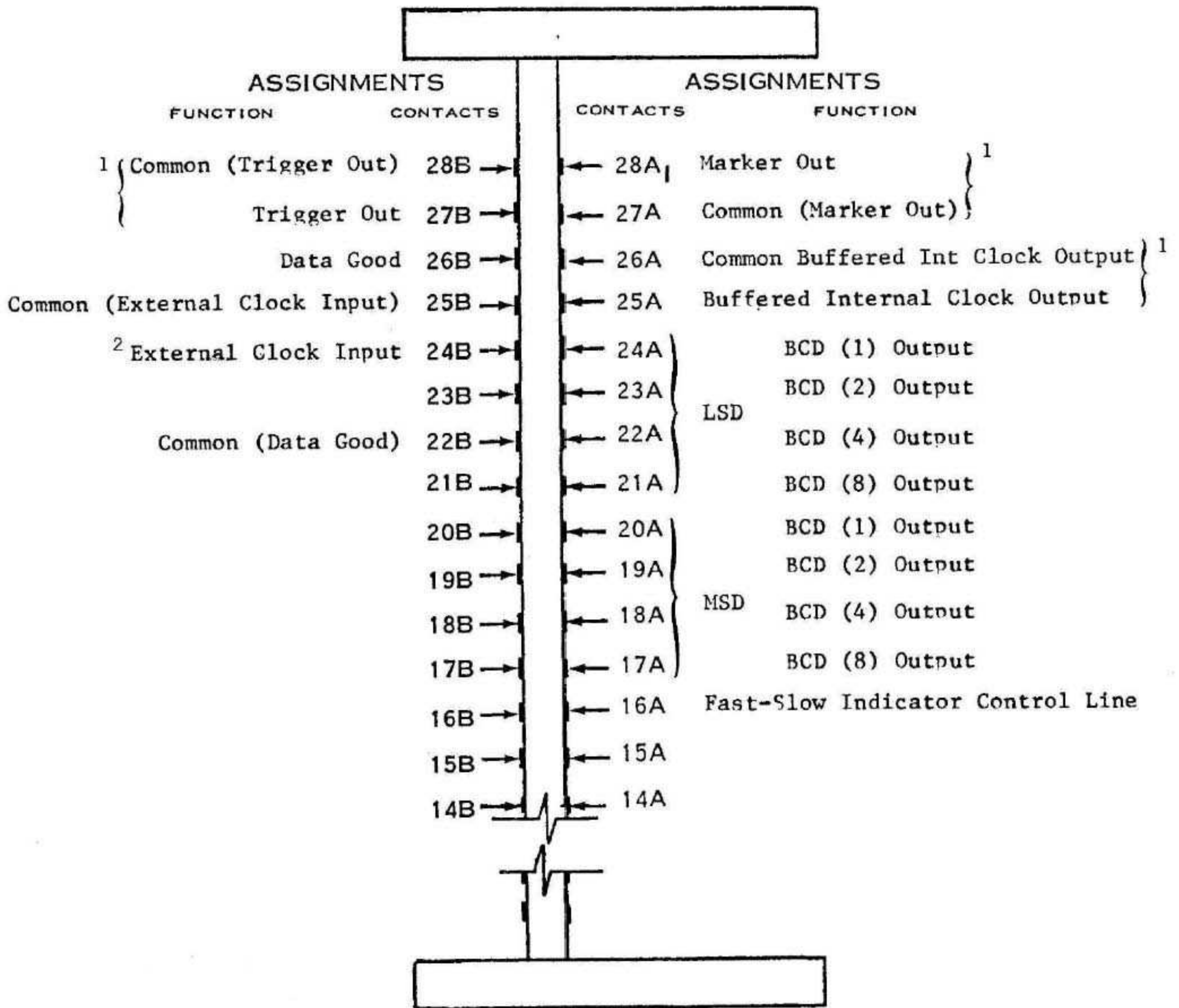

1 Customer installed wiring required.

2 Depending upon clock rate, some customer rewiring may be required.

### CAUTION

When a Power Module compartment has been selected for the TG 501 and wired for a specialized interface system, a plastic barrier (Tektronix Part No. 214-1593-02) should be installed in a key slot between contacts 23 and 24 on the Power Module.

Do not insert any TM 500 Series plug-in in a live Power Module and do not use excessive force when inserting the plug-in.

LSD - Least significant digit; MSD - Most significant digit.



## INTERFACE NOTES

## Marker Out

Marker output pulses (5 s to 2 ns) can be supplied to contact 28A by disconnecting the coaxial cable going to the MARKER OUT front-panel connector. Connect the cable to the connector at the rear of the plug-in which is connected to contact 28A, coiling the excessive cable length so that the coiled loop is near the rear of the TG 501. The output of contact 28A must be terminated into 50 ohms to maintain the integrity of the time markers.

## NOTE

*The quality of the output signal may not achieve specifications due to variables introduced by using the rear interface.*

## Buffered Internal Clock Output

Interface contact 25A supplies the internal 1 MHz clock pulses of the TG 501 for external use. To connect the internal 1 MHz clock pulses via a buffer to contact 25A, jumper J2 (see Fig. 1) must be installed. This output will drive at least 2 TTL loads (8 mA).

## BCD Outputs (LSD - 8, 4, 2, 1 and MSD - 8, 4, 2, 1 Code)

Contacts 24A, 23A, 22A, 21A, 20A, 19A, 18A and 17A provide BCD data directly to the Power Module interface. Each digit of the error count is transmitted in a serial-by-digit method. The binary levels for each digit use positive-true logic (HI=1, LO=0). Each output data line is capable of driving 2 TTL loads (3.2 mA). Caution must be exercised in connecting external loads to the BCD data lines, since they are neither buffered nor protected.

## Fast-Slow Indicator Control Line

The output level on rear contact 16A is high (about 5 V) when the SLOW indicator is lit and is low (about 0 V) when the FAST indicator is lit. This output line will drive 2 TTL load (3.2 mA). Caution must be exercised in connecting external loads to this line, since it is neither buffered nor protected.

## Trigger Out

Trigger output pulses can be supplied to contact 27B by disconnecting, at the circuit board, the coaxial cable going from the circuit board to the + TRIGGER OUT front-panel connector. Connect another 50 ohm coaxial cable (having characteristics similar to RG174U) from the circuit board

trigger output and shield solder pads (from which coaxial cable was just removed to contacts 27B (center conductor) and 28B (shield)). The output of contact 27B must be terminated into 50 ohms to maintain the integrity of the trigger pulses.

### Data Good

A positive-true pulse is transmitted directly to rear contact 26B at each updating of the counters. The Data Good pulse goes high and stays high for about 8 ms which coincides with the LED display time. This output will drive at least 2 TTL loads (3.2 mA). Caution must be exercised in connecting external loads to this line since it is neither buffered nor protected.

### External Clock Input

A 1 MHz, 5 MHz, or 10 MHz external clock can be substituted for the internal clock. Interface contact 24B is used for the external clock input with the associated ground on contact 25B.

To use an external 5 or 10 MHz clock, U50 (see manual diagram) must be installed on the back of the main circuit board (see Fig. 1) and the necessary jumpers added (see Fig. 1 and Table 1) to divide down the input to meet the 1 MHz internal requirement. For a 1 MHz external clock U50 is not required but jumpers must be added.

Standard clock. Remove U100 and disconnect pin 3 of U350 (see manual diagram) before using external clock. To disconnect pin 3 remove U350, bend pin 3 out the insert U350 back into its socket.

Option 1 clock. Remove jumper J3 (see Fig. 1) if using a 5 MHz or 10 MHz external clock. If a 1 MHz external clock is to be used, remove jumpers J3, J4 and J7, refer to Fig. 1.

If the external clock source is a TTL output, then remove R52 (see manual diagram).

TABLE 1

External Clock Frequency	Install Jumper(s) (See Fig. 1 for Location)	Remarks
1 MHz	J1 and J5	
5 MHz	J1, J4 and J7	Install U50
10 MHz	J1, J4 and J6	Install U50

Common (Marker Out, Buffered Internal Clock Output, Trigger Out, External Clock Input, and Data Good)

Contacts 27A, 26A, 28B, 25B and 22B are electrically tied to the instrument chassis. Certain contacts are recommended for specific use for connection convenience.

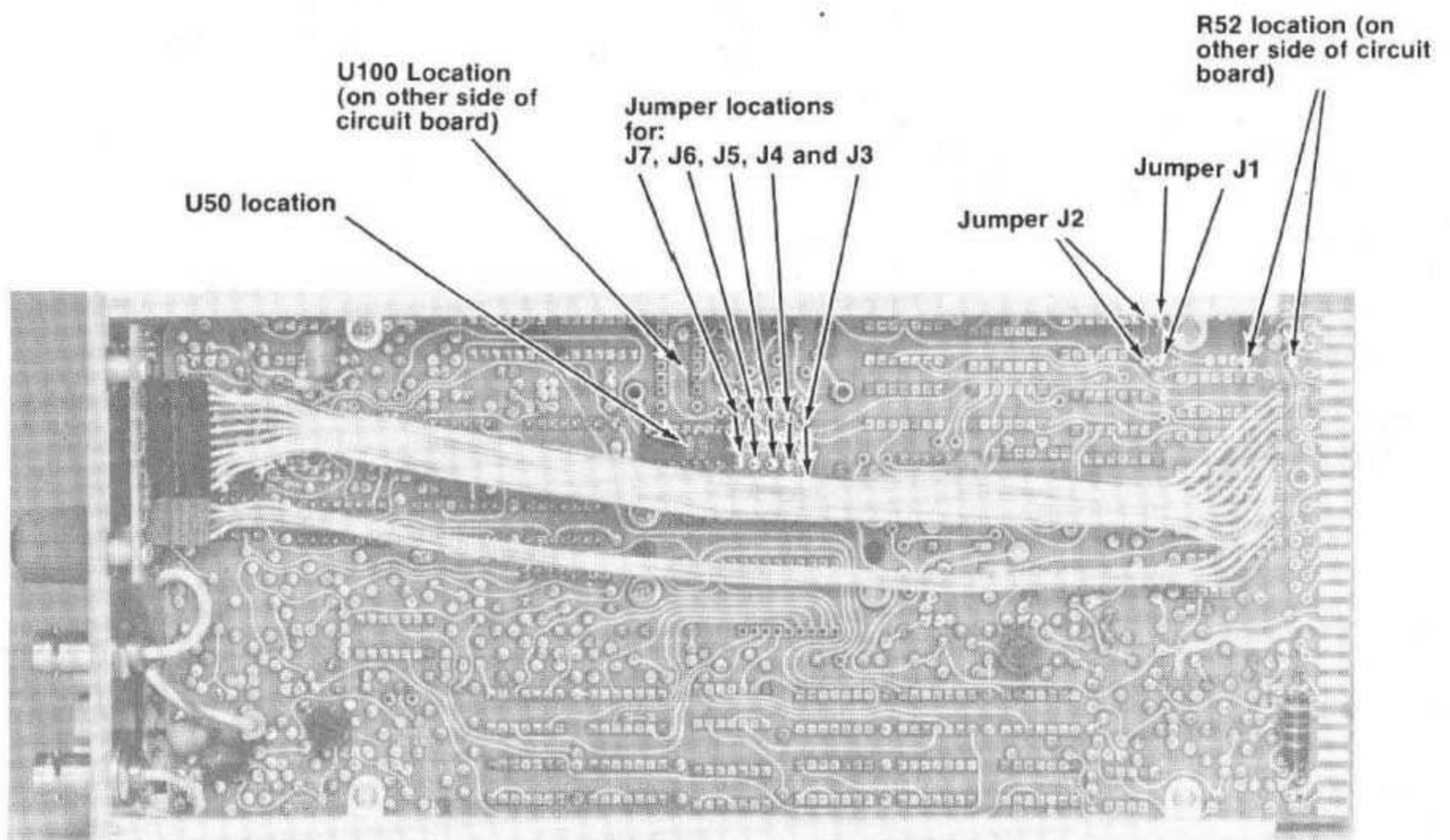

FIG. 1

**SECTION 19**  
**TRACKING GENERATORS**





## Plug-In or Power Module Rear View

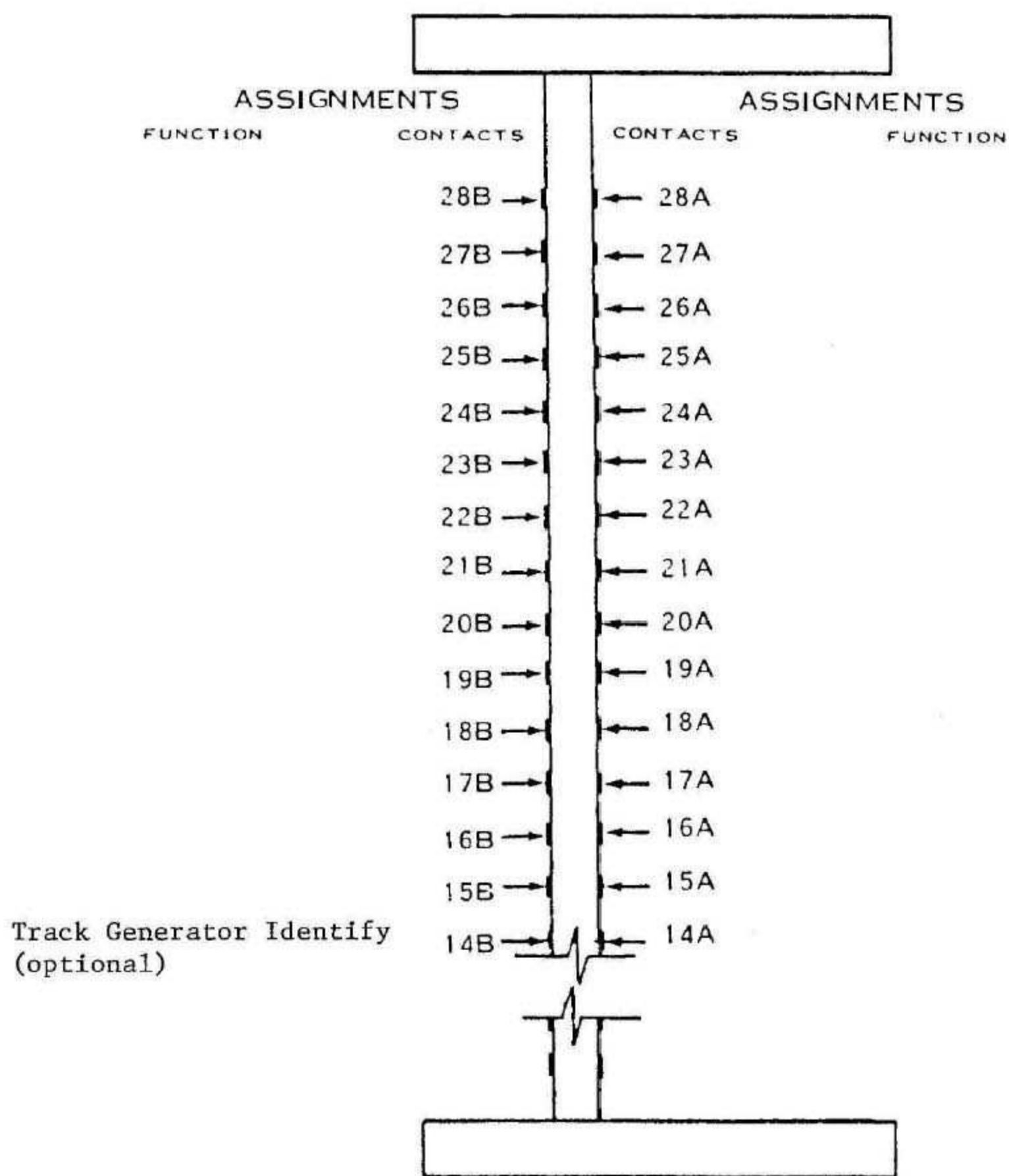

### CAUTION

*When a Power Module compartment has been selected for the TR 501 and wired for a specialized interface system, a plastic barrier (Tektronix Part Number 214-1593-02) should be installed in a key slot between contact 17 and 18 on the Power Module.*

*Do not insert any TM 500 Series plug-in in a live Power Module and do not use excessive force when inserting the plug-in.*

**Tracking—TR 501**

Track Generator Identify (14B)

This connection is grounded. Use it to identify that a TR 501 is in the particular compartment.

## Plug-In or Power Module Rear View

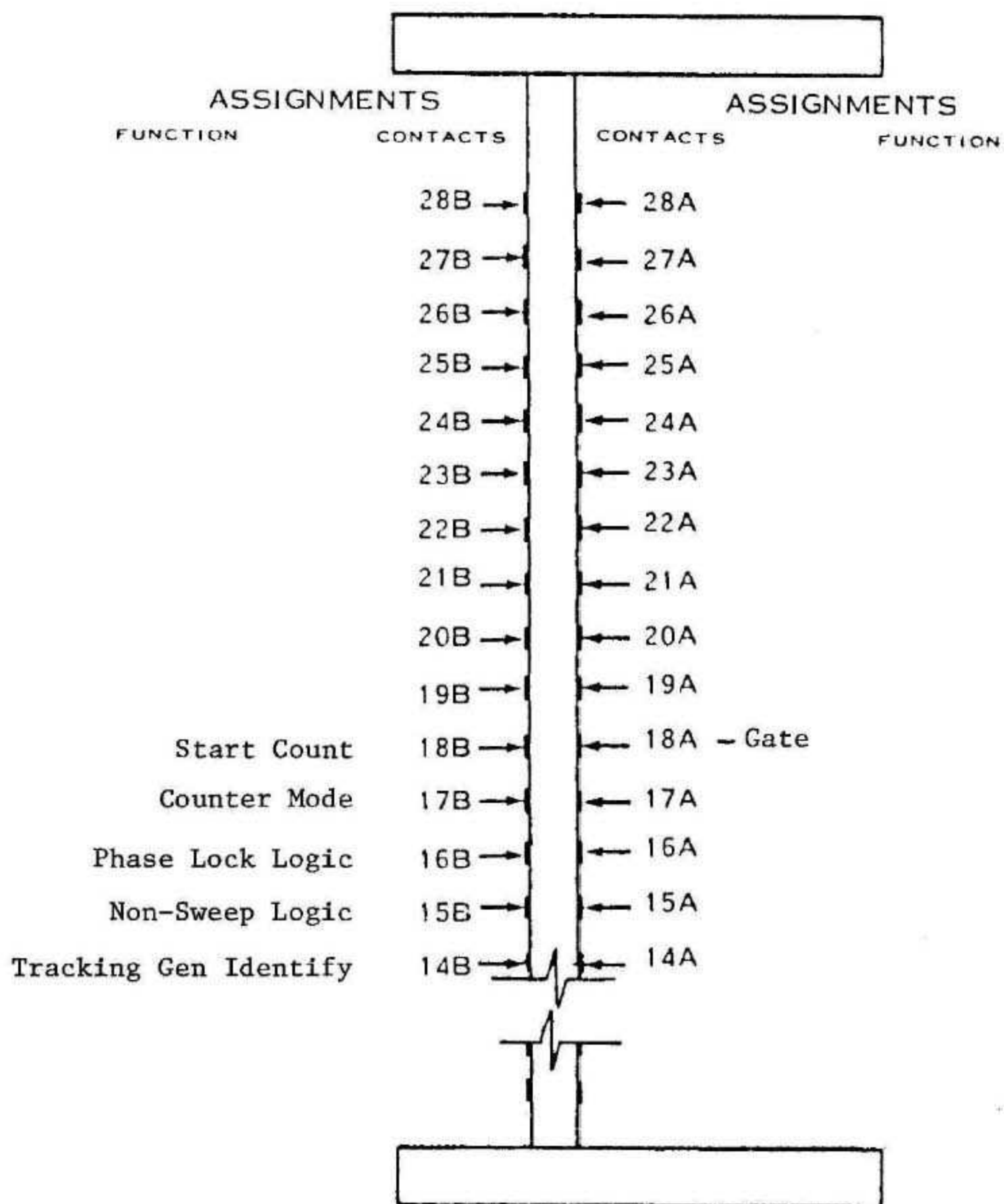

### CAUTION

When a Power Module compartment has been selected for the TR 502 and wired for a specialized interface system, (option 7) a plastic barrier (Tektronix Part Number 214-1593-02) should be installed in a key slot between contacts 17 and 18 on the Power Module.

Do not insert any TM 500 Series plug-in in a live Power Module and do not use excessive force when inserting the plug-in.



## INTERFACE NOTES

### Introduction

The rear interface connections on the TR 502 are designed for use with a TM 500 series Option 7 Power Module and DC 502 Option 7 Counter, or other counters with Option 7 available.

The TR 502 Tracking Generator is a 100 kHz to 1.8 GHz swept signal source used in conjunction with a spectrum analyzer. When used with a compatible counter, the center frequency of the sweep may be counted.

### Tracking Generator Identify (Pin 14B)

This pin is grounded. In the system it identifies the TR 502 to the counter.

### Counter Mode (Pin 17B)

This connection is a TTL input. A low at this pin identifies a counter compatible with the sweep stop scheme of frequency measurement.

### Non-sweep Logic (Pin 15B)

This TTL signal originates in the spectrum analyzer. A low at this connection indicates that the analyzer is in a non-sweep mode and for the counter to count continuously. A high at this connection identifies the sweep stop mode of counting. The counter will count on command.

### Start Count (Pin 18B)

This signal is a TTL output from the TR 502. A 1  $\mu$ s pulse on this line tells the counter to count the signal at its front panel.

### - Gate (Pin 18A)

After the compatible counter receives the start count pulse the counter responds with a TTL compatible low on this line. This pulse lasts for the duration of the count. The TR 502 holds the sweep at center while the count is made. When the count is completed, this connection returns to the high state and the frequency sweep continues.

## Phase Lock Logic (Pin 16B)

A low on this TTL line, originating in the spectrum analyzer, indicates that the local oscillator in the TR 502 is not phase locked. Frequency is read within about 100 kHz. When this line is high the local oscillator in the TR 502 is phase locked to the local oscillator in the spectrum analyzer. Counts are now accurate within 10 Hz.