



**PLEASE CHECK FOR CHANGE INFORMATION
AT THE REAR OF THIS MANUAL.**

**SG 505
OSCILLATOR
WITH OPTION 01**

Francais Deutsch 日本語

INSTRUCTION MANUAL

**Tektronix, Inc.
P.O. Box 500
Beaverton, Oregon 97077**

Serial Number _____

070-2823-00
Product Group 75

First Printing OCT 1979
Revised MAR 1986

Copyright © 1979 Tektronix, Inc. All rights reserved. Contents of this publication may not be reproduced in any form without the written permission of Tektronix, Inc.

Products of Tektronix, Inc. and its subsidiaries are covered by U.S. and foreign patents and/or pending patents.

TEKTRONIX, TEK, SCOPE-MOBILE, and  are registered trademarks of Tektronix, Inc.

Printed in U.S.A. Specification and price change privileges are reserved.

Copyright © 1979 durch Tektronix, Inc. Alle Rechte vorbehalten. Der Inhalt dieser Publikation darf ohne Genehmigung von Tektronix, Inc. nicht weitergegeben werden.

Produkte von Tektronix, Inc. und seinen Tochtergesellschaften sind durch US- und Auslandspatente und/oder schwebende Patente abgedeckt.

TEKTRONIX, TEK, SCOPE-MOBILE und  sind geschützte Warenzeichen von Tektronix, Inc.

Gedruckt in U.S.A. Spezifikations- und Preisänderungen bleiben vorbehalten.

Copyright © 1979 TEKTRONIX INC. Tous droits réservés. Le contenu de ce manuel ne peut être reproduit sous quelque forme que ce soit sans l'accord de Tektronix Inc.

Tous les produits TEKTRONIX sont brevetés US et Etranger et les logotypes TEKTRONIX, TEK SCOPE MOBILE,  sont déposés.

Imprimé aux USA. TEKTRONIX se réserve le droit de modifier : caractéristiques et prix dans le cadre de développements technologiques.

© 1979 年版權所有テクトロニクス社。不許複製。

TEKTRONIX、TEK、SCOPE-MOBILE、 はテクトロニクス社の登録商標です。

米国にて印刷。仕様及び価格は予告なく変更する場合があります。

INSTRUMENT SERIAL NUMBERS

Each instrument has a serial number on a panel insert, tag, or stamped on the chassis. The first number or letter designates the country of manufacture. The last five digits of the serial number are assigned sequentially and are unique to each instrument. Those manufactured in the United States have six unique digits. The country of manufacture is identified as follows:

B000000	Tektronix, Inc., Beaverton, Oregon, USA
100000	Tektronix Guernsey, Ltd., Channel Islands
200000	Tektronix United Kingdom, Ltd., London
300000	Sony/Tektronix, Japan
700000	Tektronix Holland, NV, Heerenveen, The Netherlands

TABLE OF CONTENTS

List of Illustrations	iii
List of Tables	iv
Operators Safety Summary	v
Servicing Safety Summary	vii

OPERATORS PART

Section 1 SPECIFICATION

Introduction	1-1
Performance Conditions	1-1
Electrical Characteristics	1-1
Front Panel	1-1
Rear Interface	1-3
Miscellaneous	1-3
Environmental	1-4
Physical Characteristics	1-4

ENGLISH VERSION

Section 2 OPERATING INSTRUCTIONS

Installation Instructions	2-1
Preparation for Use	2-1
Repackaging Information	2-2
Controls and Connectors	2-2
Operators Familiarization	2-4
General Operating Information	2-4
Output Connections	2-4
Frequency Selection	2-4
Output Level Selection	2-4
Intermodulation Test Signal	2-4
Rear Interface Signals	2-4

FRENCH VERSION

Chapitre 2 INSTRUCTIONS D'UTILISATION

Mise en route	2-1
Opérations préliminaires	2-1
Instructions d'expédition	2-1
Commandes et connecteurs	2-2
Sélection de la fréquence	2-2

Page

Sélection du niveau de sortie	2-2
Bornes de sortie	2-2
Utilisation de l'appareil	2-2
Informations générales d'utilisation ..	2-2
Connexions de sortie	2-2
Sélection de la fréquence	2-4
Sélection du niveau de sortie	2-4
Signal de test d'intermodulation (option 01)	2-4
Signaux délivrés sur le connecteur de l'interface	2-4

GERMAN VERSION

Kapitel 2 BEDIENUNGSANLEITUNG

Einbauanweisung	2-1
Bedienungselemente und Steckverbindungen	2-2
Allgemeine Bedienungsanleitung	2-4
Ausgangssignal	2-4
Frequenzwahl	2-4
Wahl des Ausgangspegels	2-4
Modulationstestsignal (Option 01) ..	2-4
Signale an der ruckseitigen Interfaceverbindung	2-4
Verpackungshinweise	2-5

JAPANESE VERSION

第 2 章 取扱説明

取付け方法	2 - 1
ご使用の前に	2 - 1
梱包方法	2 - 2
コントロールとコネクタ	2 - 2
操作方法	2 - 2
操作の前に	2 - 2
出力コネクタ	2 - 2
周波数選択	2 - 4
出力レベル選択	2 - 4
インターモジュレーション・テスト信号	2 - 4
後部インターフェイス信号	2 - 4

TABLE OF CONTENTS (cont)

SERVICE PART

WARNING

THE FOLLOWING SERVICING INSTRUCTIONS ARE FOR USE BY QUALIFIED PERSONNEL ONLY. TO AVOID PERSONAL INJURY, DO NOT PERFORM ANY SERVICING OTHER THAN THAT CONTAINED IN OPERATING INSTRUCTIONS UNLESS YOU ARE QUALIFIED TO DO SO.

Section 3	THEORY OF OPERATION	Page
	Introduction	3-1
	Phase Shift Oscillator	3-1
	Amplitude Detector	3-1
	Peak Detector	3-1
	Amplitude Control	3-1
	Output Buffer Amplifier	3-2
	Output Attenuator and Buffer Amplifier	3-2
	Sync Driver and Sync Amplifier	3-2
	Power Supply	3-2
	Intermodulation Test Signal (Option 01)	3-2
Section 4	CALIBRATION PROCEDURE	
	Introduction	4-1
	Test Equipment Requirements	4-1
	Performance Check	4-3
	Introduction	4-3
	Test Equipment Required	4-3
	Preparation	4-3
	Procedure	4-3
	Adjustments	4-13
	Introduction	4-13
	Test Equipment Required	4-13
	Preparation	4-13
	Procedure	4-13

Section 5	MAINTENANCE	Page
	Recalibration	5-1
	Obtaining Replacement Parts	5-1
	Cleaning Instructions	5-1
	Circuit Board Removal and Installation	5-1
	Low Frequency Selection (Option 01)	5-2
	Troubleshooting Aids	5-2
	Troubleshooting Equipment	5-2
	Static-Sensitive Components	5-2

Section 6 OPTIONS

Section 7 REPLACEABLE ELECTRICAL PARTS

Section 8 DIAGRAMS AND CIRCUIT BOARD ILLUSTRATIONS

Section 9 REPLACEABLE MECHANICAL PARTS AND EXPLODED VIEW

Accessories

Change Information

LIST OF ILLUSTRATIONS

Fig. No.		Page
	SG 505 Oscillator (Option 01)	viii
2-1	SG 505 installation and removal	2-1
2-2	Front panel controls and connectors	2-3
4-1	10 Hz null adjustment	4-8
4-2	10 Hz harmonic distortion display	4-8
4-3	20 Hz harmonic distortion display	4-10
4-4	20 kHz harmonic distortion display	4-10
4-5	Left side view of SG 505	4-13

NOTE

The following illustrations are located in the diagrams foldout section at the rear of this manual.

8-1	SG 505 Simplified block diagram
8-2	Oscillator board (A10)
8-3	Troubleshooting flow chart—oscillator
8-4	Troubleshooting flow chart—power supply
8-5	IMD Option board (A11)
8-6	Adjustment locations

LIST OF TABLES

Table No.		Page
1-1	Electrical Characteristics	1-1
1-2	Miscellaneous	1-3
1-3	Environmental	1-4
1-4	Physical Characteristics	1-4
4-1	List of test equipment requirements	4-1
4-2	Frequency accuracy check	4-3
4-3	Output level accuracy check	4-5
4-4	Output level step accuracy check	4-6
4-5	Level flatness check	4-7
4-6	Level flatness check	4-7
4-7	Harmonic correction factors	4-9
4-8	Factors for thd computation	4-10
5-1	Relative susceptibility to static discharge damage	5-3

NOTE

The following tables are located in the diagrams foldout section at the rear of this manual.

8-1	Rear Interface Connector Assignments
8-2	Component reference chart
8-3	Component reference chart
8-4	Component reference chart
8-5	Component reference chart

OPERATORS SAFETY SUMMARY

The general safety information in this part of the summary is for both operating and servicing personnel. Specific warnings and cautions will be found throughout the manual where they apply, but may not appear in this summary.

TERMS

In This Manual

CAUTION statements identify conditions or practices that could result in damage to the equipment or other property.

WARNING statements identify conditions or practices that could result in personal injury or loss of life.

As Marked on Equipment

CAUTION indicates a personal injury hazard not immediately accessible as one reads the marking, or a hazard to property including the equipment itself.

DANGER indicates a personal injury hazard immediately accessible as one reads the marking.

SYMBOLS

In This Manual



This symbol indicates where applicable cautionary or other information is to be found.

As Marked on Equipment



DANGER — High voltage.



Protective ground (earth) terminal.



ATTENTION — refer to manual.

Power Source

This product is intended to operate in a power module connected to a power source that will not apply more than 250 volts rms between the supply conductors or between either supply conductor and ground. A protective ground connection by way of the grounding conductor in the power cord is essential for safe operation.

Grounding the Product

This product is grounded through the grounding conductor of the power module power cord. To avoid electrical shock, plug the power cord into a properly wired receptacle before connecting to the product input or output terminals. A protective ground connection by way of the grounding conductor in the power cord is essential for safe operation.

Danger Arising From Loss of Ground

Upon loss of the protective-ground connection, all accessible conductive parts (including knobs and controls that may appear to be insulated) can render an electric shock.

Use the Proper Power Module Power Cord

Use only the power cord and connector specified for your product.

Use only a power cord that is in good condition.

Use the Proper Fuse

To avoid fire hazard, use only the fuse of correct type, voltage rating and current rating as specified in the parts list for your product.

Refer fuse replacement to qualified service personnel.

Do Not Operate in Explosive Atmospheres

To avoid explosion, do not operate this product in an explosive atmosphere unless it has been specifically certified for such operation.

Do Not Operate Without Covers

To avoid personal injury, do not operate this product without covers or panels installed. Do not apply power to the plug-in via a plug-in extender.



SERVICING SAFETY SUMMARY

FOR QUALIFIED SERVICE PERSONNEL ONLY

Refer also to the preceding Operators Safety Summary.

Do Not Service Alone

Do not perform internal service or adjustment of this product unless another person capable of rendering first aid and resuscitation is present.

Use Care When Servicing With Power On

Dangerous voltages exist at several points in this product. To avoid personal injury, do not touch exposed connections and components while power is on.

Disconnect power before removing protective panels, soldering, or replacing components.

Power Source

This product is intended to operate in a power module connected to a power source that will not apply more than 250 volts rms between the supply conductors or between either supply conductor and ground. A protective ground connection by way of the grounding conductor in the power cord is essential for safe operation.

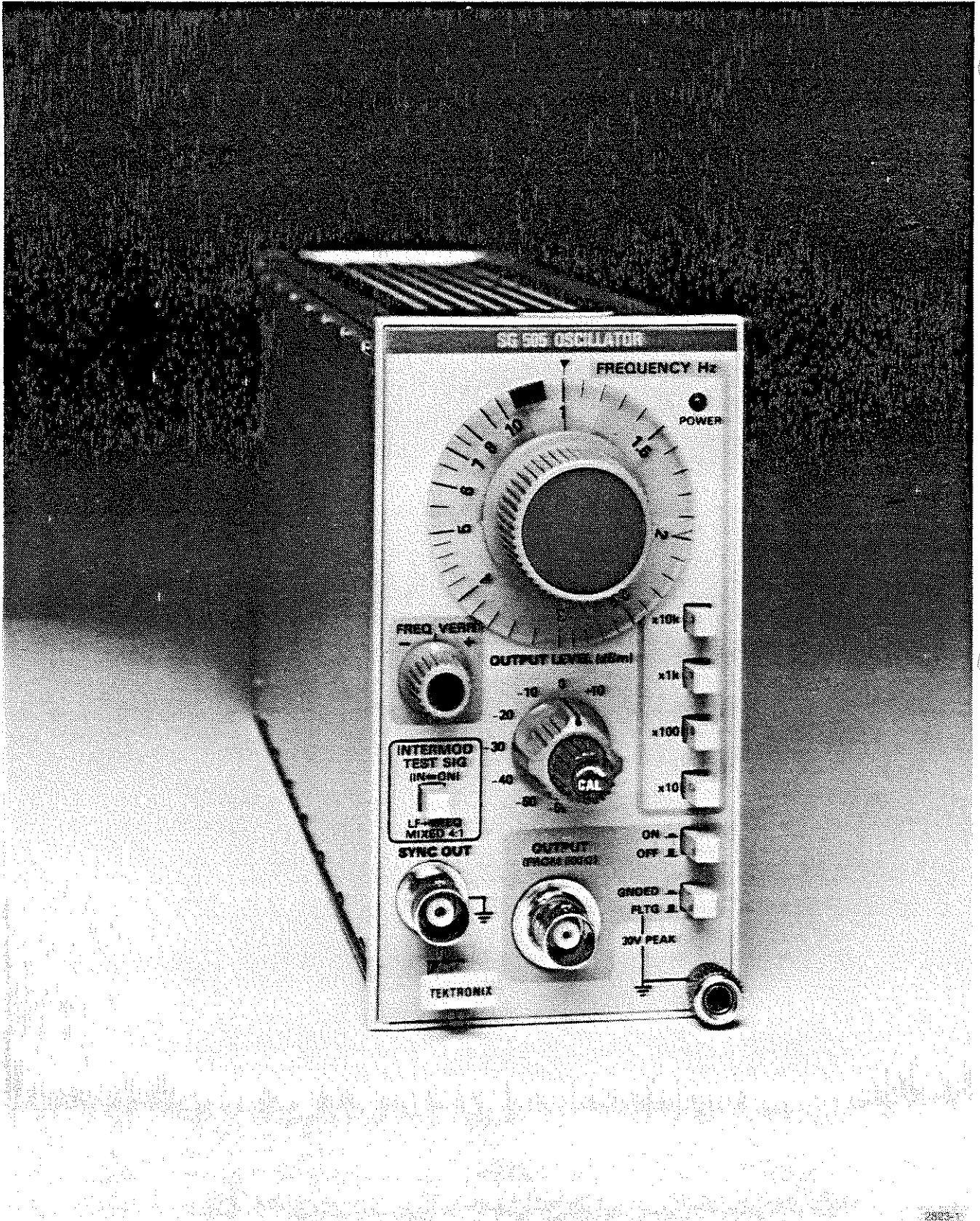

The SG 505 Oscillator.

OPERATORS PART

SPECIFICATION

Introduction

The SG 505 Oscillator generates an ultra low distortion sine wave over the frequency range from 10 Hz to 100 kHz. This signal can be floated or referenced to chassis ground. The oscillator also provides a fixed amplitude ground referenced sine wave signal at the SYNC OUT connector that is identical in frequency to the signal from the OUTPUT connector. Versions of both output signals are available at the rear interface connector.

The Option 01 SG 505 adds an intermodulation test signal function. This signal consists of a lower frequency sine wave mixed with the selected frequency in a 4:1 amplitude ratio. The lower frequency sine wave is internally selectable for 60 Hz or 250 Hz. The SG 505 is designed to operate in one compartment of any TM 500 Series Power Module.

Performance Conditions

The electrical characteristics are valid only if the SG 505 has been calibrated at an ambient temperature of +20°C to +30°C and is operating at an ambient temperature of 0°C to +50°C, unless otherwise noted.

Items listed in the Performance Requirements column of the Electrical Characteristics are verified by completing the Performance Check in the Calibration section of this manual. Items listed in the Supplemental Information column are not verified in this manual. They are either explanatory notes or performance characteristics for which no limits are specified.

Table 1-1

ELECTRICAL CHARACTERISTICS (Front Panel)

Characteristics	Performance Requirements	Supplemental Information
FREQUENCY		
Range	10 Hz to 100 kHz in four overlapping bands.	Typically 9 Hz to 110 kHz. Nominal range of each band is 0.90 to 11.0.
Vernier Range	$\geq \pm 1\%$ of frequency setting.	
Dial Accuracy	$\pm 3\%$ of setting with vernier at center.	
Drift		Typically less than 0.01%/°C and 0.03%/hour.
OUTPUT LEVEL		
Calibrated Steps	+10 dBm to -60dBm into 600 Ω in eight 10 dB steps, ± 0.2 dB at 0 dBm and 1 kHz.	
Step Accuracy	± 0.1 dB/10 dB step.	
Stability		Typically better than 0.01 dB/°C and 0.03 dB/hour.
Variable Range	$\geq +2.2$ dB to < -10 dB from calibrated position.	

Table 1-1 (cont)
ELECTRICAL CHARACTERISTICS (Front Panel)

Characteristics	Performance Requirements	Supplemental Information
OUTPUT LEVEL (cont)		
Maximum Output	-10 dBV (112.2 dBm) or 3.16 V rms into 600 Ω .	\approx 6 V rms unloaded.
Settling Time		\leq 5 seconds to 0.2 dB of final value, 20 Hz—100 kHz, typically $<$ 3 seconds above 100 Hz. Worst case transient overshoot is \leq 3 dB.
LEVEL FLATNESS (1 kHz reference)		
10 Hz—20 kHz	\pm 0.1 dB	
20 kHz—100 kHz	\pm 0.2 dB (exclude -60 dB OUTPUT LEVEL attenuator range)	
DISTORTION ($R_L \geq 600 \Omega$)		Refer to Buffered Main Output load impedance limitation under Electrical Characteristics (Rear Interface) Typically \leq 0.0003%.
20 Hz—20 kHz	\leq 0.0008% (-102 dB) thd.	
10 Hz—20 Hz, 20 kHz—50 kHz	\leq 0.0018% (-95 dB) thd.	
50 kHz—100 kHz	\leq 0.0032% (-90 dB) thd.	
OUTPUT		
Impedance	600 $\Omega \pm$ 2%.	Floating or grounded through approximately 30 Ω . Output impedance does not change with OUTPUT ON/OFF selection.
Dc Offset		\leq 1% of output ac rms voltage.
Maximum Floating Voltage		\pm 30 V peak. (0.01 μ F between output common and chassis ground in floating mode.)
Line Related Common Mode Output Voltage In Floating Mode		Typically \leq 50 mV rms into an open circuit.
SYNC OUTPUT		
Signal	Sine wave with same frequency as output. 200 mVrms \pm 20% sine wave to 20KHz, at least 120 mv at 100 KHz.	Thd is typically \leq 3% and phase shift from OUTPUT is typically \leq 5°, 20 Hz to 20 kHz.
Impedance		1 k Ω , \pm 10%, ground referenced and isolated from main output.

Table 1-1 (cont)

ELECTRICAL CHARACTERISTICS (Front Panel)

Characteristics	Performance Requirements	Supplemental Information
INTERMOD TEST SIGNAL (Optional)		
Signal	Lf sine wave mixed with normal oscillator output in a 4 (± 0.1) to 1 amplitude ratio.	SYNC OUT signal is Lf component only.
Lf Frequency	Internally selectable 60 Hz ($\pm 2\%$) or 250 Hz ($\pm 2\%$).	
Level	Composite peak-to-peak output is within ± 0.2 dB of the normal oscillator mode sine wave output.	
Residual Imd		Typically $\leq 0.0005\%$ from 2.5 kHz to 10 kHz and $\leq 0.001\%$ from 10 kHz to 20 kHz.

ELECTRICAL CHARACTERISTICS (Rear Interface)

Characteristics	Performance Requirements	Supplemental Information
Buffered Main Output		Pins 25A and 26A (common). Unity gain buffered version of the actual output signal from front panel connector. Pin 26A is electrically connected to front panel OUTPUT common. To prevent possible instrument damage, do not float output in excess of ± 30 V peak. Output impedance is approximately 600 Ω . To prevent degradation in oscillator distortion at the front panel, the rear interface load impedance must be ≥ 1 k Ω . This output is intended to provide an ac signal level reference for gain measurements. Thd is typically $\leq 0.03\%$.
Sync Output		Pins 27B and 28B (ground). Approximately 200 mV rms sine wave identical to front panel SYNC output signal. Output impedance is approximately 50 Ω and always ground referenced.

Table 1-2

MISCELLANEOUS

Characteristics	Performance Requirements	Supplemental Information
Power Consumption		6 VA or less.
Calibration Interval		1000 hours or 6 months.
Warm-up Time		30 minutes.

Table 1-3
ENVIRONMENTAL¹

Characteristics	Description	
Temperature	Meets MIL-T-28800B, class 5.	
Operating	0°C to +50°C	
Non-Operating	-55°C to +75°C	
Humidity	90-95% RH for 5 days cycled to 50°C.	Exceeds MIL-T-28800B, class 5.
Altitude	Exceeds MIL-T-28800B, class 3.	
Operating	4.6 km (15,000 ft).	
Non-operating	15 km (50,000 ft).	
Vibration	0.38 mm (0.015") 10 Hz to 55 Hz, 75 minutes. ^b	Meets or exceeds MIL-T-28800B, class 5, with exception in certain power modules. ^b
Shock	30 g's (1/2 sine), 11 ms, 18 shocks. ^c	Meets or exceeds MIL-T-28800B, class 5, with exception in certain power modules. ^c
Bench Handling	45° or 4" or equilibrium, whichever occurs first.	Meets MIL-T-28800B, class 3.
E.M.C.	MIL-STD 461A/462.	Meets MIL-T-28800B, class 3.
Electrical Discharge	20 kV maximum.	Charge applied to each protruding area of the product under test except the output terminals.
Transportation ^d	Qualified under National Safe Transit Association Preshipment Test Procedures 1A-B-1 and 1A-B-2.	
Vibration	25 mm (1") at 270 rpm for 1 hour.	
Package Drop	10 drops from 91 cm (3 ft.).	

¹ With power module except where noted.

^b 0.26 mm (0.01") 10 Hz to 55 Hz in TM 501, TM 503, TM 504, TM 506.

^c 20 g's (1/2 sine), 11 ms, 18 shocks in TM 501, TM 503, TM 504, TM 506.

^d Without power module.

Table 1-4
PHYSICAL CHARACTERISTICS

Characteristics	Description
Finish	Plastic-aluminum laminate front panel.
Net Weight	1.13 kg (2.49 lbs).
Overall Dimensions	67.06 mm (2.640") W x 308.36 mm (12.140") D x 126.24 mm (4.970") H.

OPERATING INSTRUCTIONS

INSTALLATION INSTRUCTIONS

Preparation for Use

The SG 505 Oscillator is calibrated and ready for use when received. It operates in any compartment of a TM 500 series power module. Refer to the power module instruction manual for line voltage requirements and power module operation. A list of standard accessories (and part numbers) is located in the back of this manual.

The SG 505 Option 01 instrument has an intermodulation test function that mixes a 60 Hz or 250 Hz sine wave with any selected frequency at the OUTPUT connector. The SG 505 contains an internal jumper that may be positioned to change the mixed 60 Hz sine wave to 250 Hz. The instrument is shipped with the jumper in the 60 Hz position. Refer internal jumper selection to qualified service personnel.

CAUTION

Turn the power module off before inserting or removing the plug-in; otherwise, damage may occur to the plug-in circuitry.

Check to see that the plastic barriers on the interconnecting jack of the selected power module compartment match the cutouts in the SG 505 circuit board edge connector. Align the SG 505 chassis with the upper and lower guides (see Fig. 2-1) of the selected compartment. Push the SG 505 chassis in and press firmly to seat the circuit board edge connector in the interconnecting jack. Pull out the power switch on the power module. The POWER indicator light on the front panel should light.

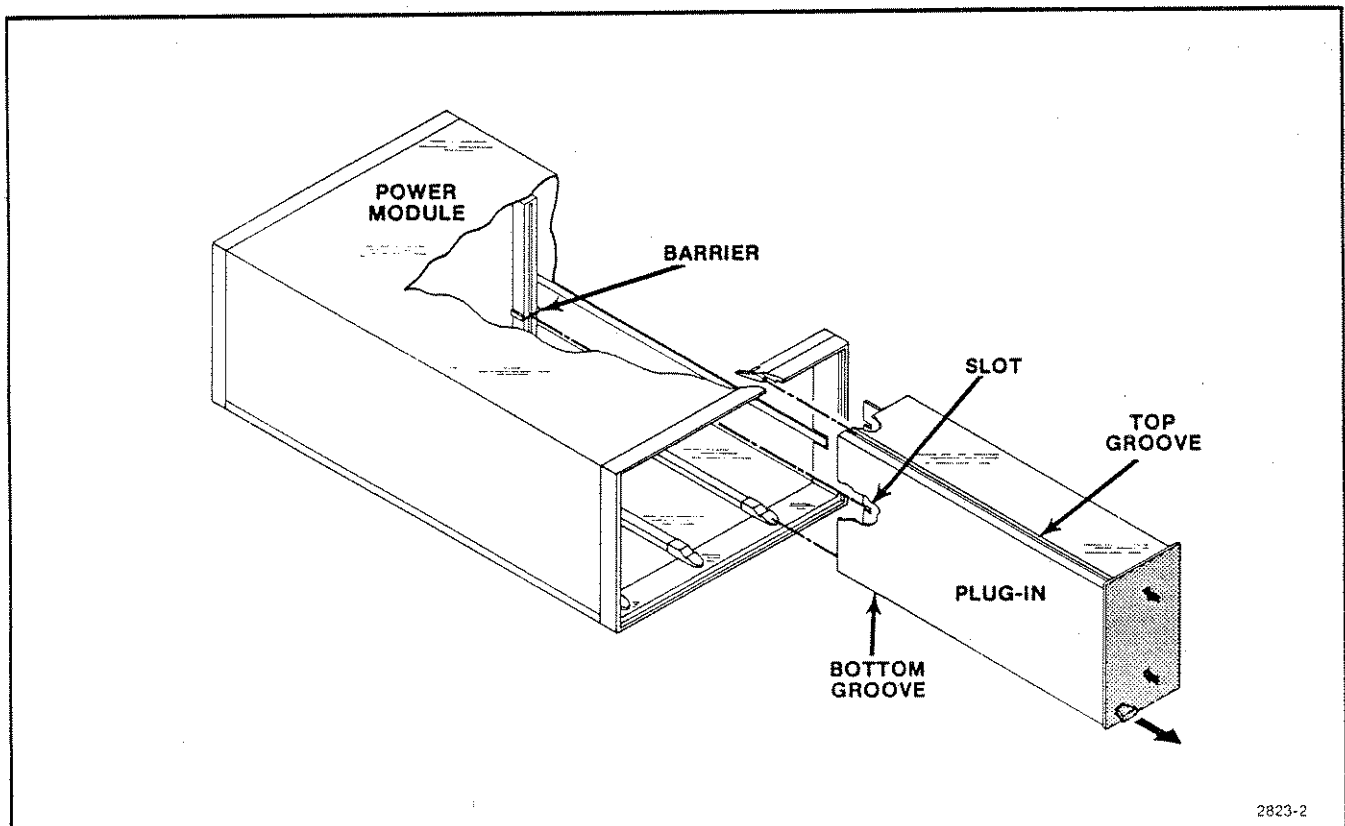

Fig. 2-1. SG 505 installation and removal.

To remove the SG 505, pull on the release latch (located in the lower left corner) until the interconnecting jack disengages and the SG 505 slides out.

Repackaging Information

If the Tektronix instrument is shipped to a Tektronix Service Center for service or repair, attach a tag showing owner (with address) and the name of an individual at your firm to contact. Include the complete instrument serial number and a description of the service required.

Save and reuse the package in which your instrument was shipped. If the original packaging is unfit for use or not available, repackage the instrument as follows:

Surround the instrument with polyethylene sheeting to protect the instrument finish. Obtain a carton of corrugated cardboard of the correct carton strength having inside dimensions of no less than six inches more than the instrument dimensions. Cushion the instrument by tightly packing three inches of dunnage or urethane foam between carton and instrument on all sides. Seal the carton with shipping tape or an industrial stapler.

The carton test strength for this instrument is 200 pounds per square inch.

CONTROLS AND CONNECTORS

FREQUENCY SELECTION

- ① **FREQUENCY Hz Dial**
Provides continuous frequency selection within each pushbutton selected frequency range.
- ② **Multiplier Pushbuttons**
Select any one of four frequency ranges.
- ③ **FREQ VERNIER Dial**
Adjusts frequency $\pm 1\%$ from selected frequency.

OUTPUT LEVEL SELECTION

- ④ **OUTPUT LEVEL (dBm) Dial**
Selects one of eight amplitude level steps, calibrated in dBm, into a 600 Ω load.
- ⑤ **OUTPUT LEVEL (dBm) CAL Dial**
Provides continuous amplitude adjustment above and below the calibrated OUTPUT LEVEL (dBm) steps.
- ⑥ **INTERMOD TEST SIG Pushbutton (Option 01)**
Pushbutton in provides a 60 Hz or 250 Hz (see Preparation for Use) sine wave mixed with any selected output frequency in a 4:1 amplitude ratio. Also provides a 60 Hz or 250 Hz sine wave at the SYNC OUT connector.
- ⑦ **ON-OFF Pushbutton**
Connects or disconnects the signal to the OUTPUT connector.

- ⑧ **GNDED-FLTG Pushbutton**
GNDED connects the OUTPUT connector outer conductor (shield) to chassis ground through a low impedance.
FLTG connects the outer conductor to ground through a capacitor for floating operation.

OUTPUT CONNECTORS

- ⑨ **OUTPUT Connector**
Provides a sine wave signal at a frequency selected by the FREQUENCY Hz dial and multiplier pushbutton at an amplitude selected by the OUTPUT LEVEL (dBm) dial (Option 01, see INTERMOD TEST SIG Pushbutton (6)).
- ⑩ **SYNC OUT Connector**
Provides ≈ 200 mV rms fixed amplitude and ground referenced sinusoidal signal at the same frequency as the OUTPUT signal. (Option 01, see INTERMOD TEST SIG Pushbutton (6)).
- ⑪ **Ground Binding Post**
Chassis ground.
- ⑫ **Release Latch**
Pull to remove plug-in from the power module.
- ⑬ **POWER Indicator**
Indicator lights when power is applied to instrument from power module.

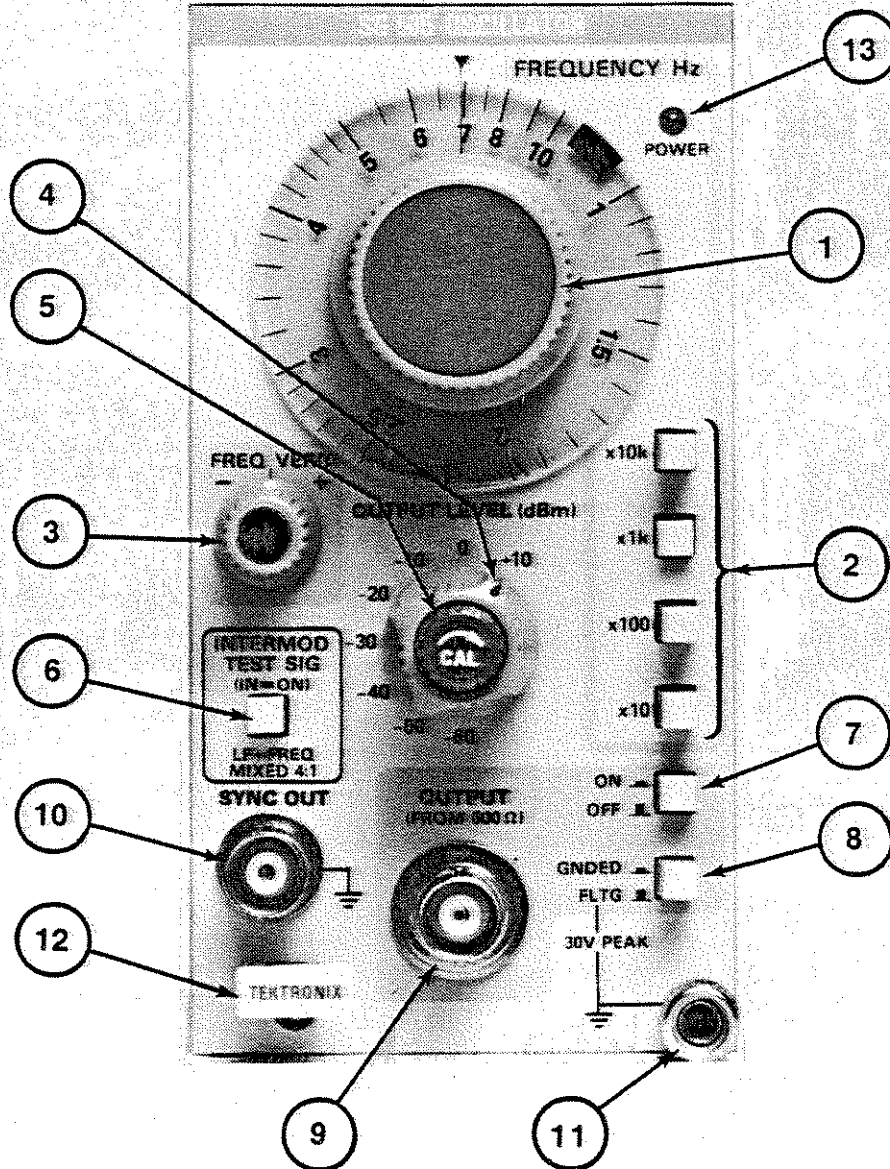

Fig. 2-2. Front panel controls and connectors.

OPERATORS FAMILIARIZATION

General Operating Information

With the SG 505 properly installed in the power module, allow thirty minutes warmup time for operation to specified accuracy.

Output Connections

The output of the SG 505 at the OUTPUT connector is designed to operate as a 600 Ω voltage source working into a 600 Ω load. At higher frequencies, an unterminated or improperly terminated output may reduce amplitude accuracy. Loads less than 600 Ω may cause waveform distortion. To ensure waveform purity, observe the following precautions:

1. Use good quality coaxial cables and connectors.
2. Make all connections tight and as short as possible.

The signal at the SYNC OUT connector is designed for use as an external trigger for a counter, oscilloscope, or other device. This output is approximately 200 mV rms with a source impedance of 1 k Ω , and is always referenced to chassis ground (even when the main OUTPUT is floating).

With the Option 01 INTERMOD TEST SIG pushbutton in, the OUTPUT signal at the SYNC OUT connector is replaced by either 60 Hz or 250 Hz (depending on the internal jumper setting).

CAUTION

To avoid damage to the SG 505 circuitry, do not apply a voltage exceeding 30 V peak, with respect to chassis ground, to any front panel connector or to rear interface connector pins 14A-28A and 14B-28B.

Frequency Selection

The SG 505 produces a sine wave signal at any frequency from 10 Hz to 100 kHz. To set the frequency, set the FREQUENCY Hz dial to the desired frequency and press the appropriate multiplier pushbutton. The FREQUENCY VERNIER dial may be used to adjust the OUTPUT frequency 1 percent above and below the frequency selected by the FREQUENCY Hz dial and multiplier pushbutton. With the FREQUENCY VERNIER dial at the center position, the output frequency produced is the FREQUENCY Hz dial setting multiplied by the active multiplier value. Signals at the OUTPUT and SYNC OUT connectors are of the same frequency. The SYNC OUT signal can be used as an external signal for monitoring the OUTPUT,

provided no more than approximately 200 mV is required from the SYNC OUT connector.

Output Level Selection

The OUTPUT LEVEL dial selects eight level steps from +10 dBm to -60 dBm. The CAL control, concentric within the OUTPUT LEVEL (dBm) dial, permits continuous adjustment above and below the calibrated output level steps. The signal at the OUTPUT connector may be ground referenced or floated up to ± 30 V peak, using the FLTG-GNDED pushbutton. The ON-OFF pushbutton connects or disconnects the signal at the OUTPUT connector.

Intermodulation Test Signal (Option 01)

With the INTERMOD TEST SIG pushbutton in, a 60 Hz or 250 Hz sine wave is mixed with any selected frequency at the OUTPUT connector in a 4:1 amplitude ratio. The composite peak-to-peak amplitude is set equal to the peak-to-peak amplitude of the unmodulated OUTPUT signal. The Intermod Test Sig LF frequency sine wave is selectable (60 Hz or 250 Hz) by means of an internal jumper. The SG 505 is shipped with the internal jumper in the 60 Hz position. Refer internal frequency selection to qualified service personnel. (Information for internal selection is provided in the Maintenance Section of this manual.)

In the INTERMOD TEST SIG mode, the SYNC OUT connector provides only the 60 Hz or 250 Hz sine wave.

Rear Interface Signals

A unity gain buffered OUTPUT signal is available at rear interface connector pins 25A and 26A (common). When the rear interface OUTPUT signal is used, the rear interface load impedance (pins 25A and 26A) must be ≥ 1 k Ω , to prevent OUTPUT amplitude distortion. The ON-OFF and FLTG-GNDED pushbuttons affect the rear interface output signal as previously described for the front panel OUTPUT signal.

The signal at the front panel SYNC OUT connector is also available at the rear interface connector, pins 27B and 28B (ground). The output impedance at these rear interface pins is approximately 50 Ω and the signal is always referenced to ground. In an Option 01 instrument, the INTERMOD TEST SIG pushbutton also affects the rear interface SYNC OUT signal as described for the front panel SYNC OUT signal.

WARNING

THE FOLLOWING SERVICING INSTRUCTIONS ARE FOR USE BY QUALIFIED PERSONNEL ONLY. TO AVOID PERSONAL INJURY, DO NOT PERFORM ANY SERVICING OTHER THAN THAT CONTAINED IN OPERATING INSTRUCTIONS UNLESS YOU ARE QUALIFIED TO DO SO. REFER TO OPERATORS SAFETY SUMMARY AND SERVICE SAFETY SUMMARY PRIOR TO PERFORMING ANY SERVICE.

SERVICE PART

THEORY OF OPERATION

Introduction

This section describes the SG 505 circuitry. The description is divided into parts that correspond to the circuit blocks shown on the block diagram in the Diagrams section of this manual. Each of these circuit blocks is also outlined in gray on the circuit diagram on which it is shown. The numbered diamond by each title of the following description refers to the corresponding circuit diagram number. The A10 or A11 number identifies the board assembly containing the circuit.

Phase Shift Oscillator A10

The phase shift or state variable oscillator consists of U1510, U1400, U1401, and associated components. Two integrators, U1400 and U1401, each having a 90° phase shift, are cascaded in a loop with inverter U1510. Combining the phase inversion of U1510 with the two 90° phase shifts of the integrators causes a 360° phase shift necessary for oscillation. Feedback occurs from pin 6 of U1401 to pin 2 of U1510 through R1517 and R510.

The output voltage rate of change of an integrator is proportional to the input voltage amplitude. The integrator timing capacitors and gain determine the oscillator frequency. The gain around the loop is unity at the oscillation frequency.

Multiplier pushbuttons S1410 select the timing capacitors across the integrators for each frequency range. The FREQUENCY Hz dial adjusts R520 and R530 to control the gain of the integrators. A small adjustment in the gain of U1510, through R510, providing a $\pm 1\%$ change in frequency, is accomplished by the frequency vernier dial.

The signal from U1401 is routed to a network consisting of Q1410, Q1411, and associated resistors and diodes. This network composes a clamp that limits the maximum output voltage from U1401 to no greater than 3 dB above the selected oscillator output level. Output voltage surges created at initial instrument turn on, or due to switching transients, are effectively eliminated.

Amplitude Detector A10

This circuitry provides an accurate relatively long time constant agc voltage. The output signal from U1401 is also fed to the amplitude detector circuit U1500 (an amplitude controlled integrator). U1500 compares the output of U1401 to the reference voltage (-15 V supply). The average current through R1504 equals the current through R1503 when the output of U1401 is 2 V rms. The output of U1500 sets the input offset voltage to the peak detector, Q1600 and Q1610.

Peak Detector A10

This circuitry provides a fast agc correction voltage. The offset voltage from U1500 and the ac signal from U1510 (coupled through C1603) are fed to a peak detector consisting of Q1600. This circuitry produces a negative dc output voltage on the agc line proportional to the negative peak voltage of the ac signal from U1510. Agc filter capacitors consist of combinations of C1611 and C1421, C1523, and C1420, depending on the frequency range selected. Between peaks, the agc filter capacitors charge from positive current source Q1611. Thus, the signal at the agc test point is a sawtooth waveform with a fast negative transition and a positive-going linear ramp. The network consisting of R1502 and C1502 provides cancellation of the fundamental frequency component of the agc signal.

Amplitude Control A10

The amplitude of the phase shift oscillator output is controlled by Q1501. Agc voltage generated by the peak detector and the amplitude detector controls the gate of Q1501. Components R1511, R1512, R1510, R1513, C1511, and C1510 form a voltage divider network. This voltage divider causes an ac signal that is one-half the amplitude of the signal appearing at the drain to drive the gate of Q1501. A more positive gate voltage at Q1501 causes an increase in oscillator amplitude by reducing the input signal at pin 3 of U1510.

Output Buffer Amplifier  **A10**

The output signal from U1401 is fed through R1520, R1521, R1423, and R1518 to the output buffer amplifier U1520. The voltage gain of U1520 is set by R1518, the OUTPUT LEVEL (dBm) CAL control, and is variable from about 0.3 to 3. When this control is fully cw, the ganged switch is open and the buffer output amplitude is at the calibrated level set by R1423. Trimmer R1423 is internally adjusted to set the level at the OUTPUT connector to 0 dBm (with S1710 in the 0 dBm position).

Output Attenuator and Buffer Amplifier  **A10**

The signal from the output buffer amplifier is fed through ON-OFF switch S1410E to output attenuator network R1720. This network has a constant output impedance of 600 Ω and provides eight output levels. Switch S1710 selects the output level tap for each of the eight output levels from +10 dBm to -60 dBm. From S1710, the signal passes to the front panel OUTPUT connector and to the main output buffer amplifier, U1700. Amplifier U1700 isolates the front panel OUTPUT connector from rear interface connector pin 25A.

Sync Driver and Sync Amplifier  **A10**

An optical isolator is used in this circuitry because the SYNC OUT connector is connected to chassis ground. Output from U1401 also passes through U1300 to the base of Q1300. Transistor Q1301 produces a dc bias current (necessary to operate the LED in the linear region) which is combined with the ac current at the oscillator frequency. Sync Level Adjustment R1301 sets the gain of U1300 for an output of 200 mV rms at the SYNC OUT connector. The current through the LED section of optical isolator U1300 varies the intensity of emitted light. This light intensity controls the current through the transistor section of the optical isolator. The sync amplifier, consisting of Q1300, R1201, and R1200, converts the output current from U1300 to voltage. The output of Q1300 is coupled through R1204 to the front panel SYNC OUT connector and through R1202 to rear interface connector pin 27B.

Power Supply  **A10**

Power is supplied to the SG 505 from the 25 V ac floating winding of the power module. The 25 V ac is applied to the primary winding of T1220. Each of the two secondary windings supplies 25 V ac, which is rectified by bridge rectifiers CR1113 and CR1114 and filtered by C1212 and C1211.

The two series pass transistors in the power module and U1101A and U1101B regulate the +15 V and -15 V

supply voltages. Resistors R1206 and R1205 divide the +15 V to +8.2 V at pin 5 of U1101B. Operational amplifier U1101B compares the voltage at pin 5 with the +8.2 V reference voltage at pin 6, supplied by VR1201. The output of U1101B drives the series pass transistor in the power module. If the voltage at pin 5 of U1101B moves below +8.2 V, the output of U1101B goes more negative, causing more base current flow in the PNP series pass transistor. This raises the +15 V to the level where U1101B can function. Resistor R1207 and C1200 decouple the +15 V used in the output amplifier.

The -15 V supply tracks the +15 V supply. Operational amplifier U1101A compares the voltage at pin 3 to the floating ground potential at pin 2. The voltage at the junction of the voltage divider R1102 and R1101 is 0 V if the +15 V and -15 V supply voltages are correct. If the -15 V supply voltage moves toward ground, the output of U1101A goes more positive, causing increased base current and conduction in the NPN series pass transistor which causes the -15 V to go more negative. FET Q1110 provides base current to the PNP series pass transistor at instrument turn on.

Current limit for the +15 V supply is provided by CR1111, CR1112, and R1120. The maximum output for each supply is 200 mA. At this current the series pass transistor base voltage is ≈ 1.4 V more negative than ground. If the output of U1101B attempts to drive the transistor base voltage more negative than -1.4 V, the current limiting diodes conduct, clamping the base at -1.4 V. The base to emitter voltage of the series pass transistor is limited by the voltage drop across R1120. The negative current limit operates in a similar manner.

Intermodulation Test Signal (Option 01)  **A11**

Option 01 instruments include an intermodulation test signal that mixes a 60 Hz or 250 Hz sine wave with the selected frequency in a 4:1 amplitude ratio (four parts low frequency to one part selected frequency). The circuit contains a Wein-bridge oscillator composed of U1100 and associated components. To select a 60 Hz output at U1100, jumper P1100 is removed from the circuit. The oscillator frequency is set to 60 Hz by C1100, C1200, R1102, and R1103. With the jumper positioned across J1100, resistors R1101 and R1104 are added to the circuit changing the frequency to 250 Hz.

A peak detector consisting of CR1110 and Q1110 controls the gain of the oscillator by adjusting the voltage at the gate of Q1111. Resistor R1211 is an internal adjustment that sets the amplitude of the signal from U1100.

CALIBRATION PROCEDURE

Introduction

This section consists of a Performance Check and an Adjustments procedure. The Performance Check verifies the electrical specifications listed under Performance Requirements in the Specifications section of this manual. The Adjustments procedure describes a sequential adjustment of internal controls should it be necessary to restore the instrument performance to the electrical specifications listed in the Specifications section.

Tektronix, Inc. provides complete instrument repair and calibration at local Field Service Centers and at the

Factory Service Center. Contact your local Tektronix Field Office or representative for further information.

Test Equipment Requirements

Below is a list of equipment required to perform the Performance Check and Adjustments procedure. Other equipment may be substituted when suitable. Tolerances that are specified in the Performance Check and Adjustments procedure apply to the instrument under test and do not include test equipment error.

Table 4-1

LIST OF TEST EQUIPMENT REQUIREMENTS

Description	Performance Requirements	Application		Example
		Performance Check Step	Adjustments Step	
TM 500 Series Power Module		All steps	All steps	TEKTRONIX TM 503, TM 504, or TM 506
Counter	0.1 Hz resolution at 100 kHz.	1, 2, 13	1	TEKTRONIX DC 504 Digital Counter ^b
Calibration Fixture	80 dB notch at 10 Hz, 20 Hz; 60 dB notch at 20 kHz, 50 kHz, 100 kHz.	3, 4, 5, 6, 7, 8, 9, 10	2	TEKTRONIX 067-0938-00 Calibration Fixture ^b
Wide Band Rms Voltmeter ^a	±0.4% from 25 Hz to 100 kHz. ±0.6% from 10 Hz to 25 Hz.	3, 4, 6, 7, 10, 11	2, 3	Hewlett Packard 3403C True Rms Voltmeter
Rms Voltmeter ^a	±0.2% at 1 kHz.	3, 6, 10, 11	2, 3	TEKTRONIX DM 501A Digital Multimeter ^b
Oscilloscope		5, 8, 9, 12	4	TEKTRONIX 7704A or 7603 Oscilloscope
Vertical Amplifier	General purpose, Bandwidth; 10 MHz.	12	4	TEKTRONIX 7A15A Vertical Amplifier
Differential Comparator Amplifier	Comparison voltage; 6 V overload capability, 50 mV/div gain.	5, 8		TEKTRONIX 7A13 Differential Comparator
Time Base	General purpose, 10 μs/div sweep rate.	5, 8, 12	4	TEKTRONIX 7B50A Time Base

Table 4-1 (cont)

Description	Performance Requirements	Application		Example
		Performance Check Step	Adjustments Step	
Spectrum Analyzer	10 Hz resolution; 80 dB dynamic range; -60 dB reference level.	9		TEKTRONIX 7L5/L3 Spectrum Analyzer
Differential Amplifier	Gain of 10, 100, 1000; output swing >10 V.	4, 5, 9		TEKTRONIX AM 502 Differential Amplifier ^b
4 ea. coaxial cables with male bnc connectors	50 Ω	All steps	All steps	-Tektronix Part No. 012-0057-01
1 ea. Extender Cable			All steps	Tektronix Part No. 067-0645-02
Bnc T Adapter		10		Tektronix Part No. 103-0030-00
Termination	50 Ω	9		Tektronix Part No. 011-0049-01
1 ea. coaxial cable	50 Ω, 18 inch	3, 4, 5, 6, 7, 8, 9	2	Tektronix Part No. 012-0076-00

^a Either rms voltmeter may be used for those steps listed in common.

^b Requires a TM 500 Series Power Module.

The numbers in Table 4-1 columns refer to the Performance Check or Adjustment Step in which the equipment is used. The following list indexes the steps for each procedure.

Performance Check steps:

1. Check Frequency Accuracy
2. Check Frequency Vernier Range
3. Check Output Level Accuracy
4. Check Output Level Step Accuracy
5. Check Output Level Step Accuracy (alternative method)
6. Check Output Level Variable Range
7. Check Level Flatness
8. Check Level Flatness (alternative method)

9. Check Distortion
10. Check Output Impedance
11. Check Sync Out Amplitude
12. Check Intermodulation Test Signal Ratio (Option 01)
13. Check Intermodulation Test Signal Frequency (Option 01)

Adjustment Procedure steps:

1. Adjust Frequency Hz Dial
2. Adjust Output Level Amplitude
3. Adjust Sync Out Amplitude
4. Adjust Intermodulation Test Signal Ratio (Option 01)

PERFORMANCE CHECK

Introduction

This procedure checks the electrical characteristics of the SG 505 listed under Performance Requirements in the Specifications section of this manual. If the instrument fails to meet the requirements given in this Performance Check, the Adjustments procedure should be performed. Do the Performance Check with the instrument operating at an ambient temperature of 0°C to 50°C. For convenience, some steps in this procedure check the performance of this instrument at only one value in the specified performance range. Any value, with appropriate limits, within the specified range may be substituted.

Test Equipment Required

Test equipment used in the Performance Check is listed in Table 4-1 at the beginning of this section.

Preparation

1. Ensure that all power switches are off and that the power module and all test equipment are adapted for the line voltage available.

2. Install the SG 505 in the power module and connect the power module and test equipment to the line voltage source.

3. Turn on the power module and test equipment. Allow at least 30 minutes warm-up time for the SG 505 (60 minutes after storage in a high humidity environment).

b. Connect the SG 505 SYNC OUT through a coaxial cable to the counter input.

c. Set the counter resolution and the SG 505 controls as listed in Table 4-2.

Table 4-2
FREQUENCY ACCURACY CHECK

Counter Resolution	SG 505 Frequency Hz		Counter Reading Limits (kHz)
	Dial	Pushbutton	
0.1 Hz	1	x 10	0.0097 to 0.0103
	2		0.0194 to 0.0206
	5		0.0485 to 0.0515
	7		0.0679 to 0.0721
	10		0.0970 to 0.1030
1 Hz	1	x 100	0.097 to 0.103
	2		0.194 to 0.206
	5		0.485 to 0.515
	7		0.679 to 0.721
	10		0.970 to 1.030
1 Hz	1	x 1k	0.970 to 1.030
	2		1.940 to 2.060
	5		4.850 to 5.150
	7		6.790 to 7.210
	10		9.700 to 10.300
10 Hz	1	x 10k	9.70 to 10.30
	2		19.40 to 20.60
	5		48.50 to 51.50
	7		67.90 to 72.10
	10		97.00 to 103.00

d. CHECK—that the counter reads within the limits listed in Table 4-2.

e. Leave the connections and control settings and proceed to the next step.

PROCEDURE

1. Check Frequency Accuracy

a. Set the SG 505 controls as follows:

FREQ VERNIER	centered
OUTPUT LEVEL (dBm)	0
OUTPUT LEVEL (dBm)	
CAL	fully cw
ON-OFF	ON (in)
GND-FLTG	FLTG (out)
INTERMOD TEST SIG	
Pushbutton (Opt.)	OFF (out)

2. Check Frequency Vernier Range

a. Change the SG 505 controls as follows:

FREQUENCY Hz Dial	1
FREQUENCY Hz	
Pushbutton	x 1k

**Calibration Procedure—SG 505
Performance Check**

- b. Set the counter resolution to 1 Hz.
- c. Adjust the FREQUENCY Hz dial for a counter reading of 1000 Hz.
- d. Rotate the FREQ VERNIER control fully ccw.
- e. CHECK—that the counter reading is ≤ 0.990 kHz.
- f. Rotate the FREQ VERNIER control fully cw.
- g. CHECK—that the counter reads ≥ 1.010 kHz.
- h. Remove all connections to the SG 505.

3. Check Output Level Accuracy

- a. Set the SG 505 controls as follows:

FREQUENCY Hz Dial	1
FREQUENCY Hz	
Pushbutton	x 1k
FREQ VERNIER	centered
OUTPUT LEVEL (dBm)	0
OUTPUT LEVEL (dBm)	
CAL	fully cw
ON-OFF	ON (in)
GNDED-FLTG	FLTG (out)
INTERMOD TEST SIG	
Pushbutton (Opt.)	OFF (out)

- b. Connect the SG 505 OUTPUT through a coaxial cable to the calibration fixture (067-0938-00) input.
- c. Connect the calibration fixture Output through an 18 inch coaxial cable to the rms voltmeter input.
- d. Set the calibration fixture Mode to Flat (out) and Atten to 0 dB (out).
- e. CHECK—that the rms voltmeter reads between 0.757 and 0.793 V rms.
- f. Remove all connections to the SG 505.

4. Check Output Level Step Accuracy

Step 5 is an alternative method for checking output level step accuracy. Either step 4 or step 5 may be performed.

- a. Set the SG 505 controls as follows:

FREQUENCY Hz Dial	1
FREQUENCY Hz	
Pushbutton	x 1k
FREQ VERNIER	centered
OUTPUT LEVEL (dBm)	+10
OUTPUT LEVEL (dBm)	
CAL	fully cw
ON-OFF	ON (in)
GNDED-FLTG	FLTG (out)
INTERMOD TEST SIG	
Pushbutton (Opt.)	OFF (out)

- b. Connect the SG 505 OUTPUT through a coaxial cable to the calibration fixture Input.
- c. Connect the calibration fixture Output through an 18 inch coaxial cable to the differential amplifier + input.
- d. Connect the differential amplifier output through a coaxial cable to the wide band rms voltmeter input. Set the differential amplifier inputs to dc coupled and not grounded. Set the high frequency 3 dB control to 1 MHz and the low frequency 3 dB control to 0.1 Hz.
- e. Set the calibration fixture Mode to Flat (out) and Atten to 0 dB (out).
- f. Set the differential amplifier gain to the first value shown in Table 4-3.
- g. Set the SG 505 OUTPUT LEVEL (dBm) control to the first value listed in the table.
- h. Adjust the differential amplifier variable gain for the first rms voltmeter reading shown in the table.
- i. Set the SG 505 OUTPUT LEVEL (dBm) control to the second value listed in the table.
- j. CHECK—that the rms voltmeter reads within the limits listed in Table 4-3.
- k. Repeat step 4 parts f through j for each of the remaining lines in the table.

Table 4-3

OUTPUT LEVEL STEP ACCURACY CHECK

Differential Amplifier Gain	SG 505 OUTPUT LEVEL	Adjust Gain for Rms Voltmeter Reading	SG 505 OUTPUT LEVEL	Rms Voltmeter Reading Limits
x1	+10 dBm	1.800 V	0 dBm	0.562 to 0.576 V
x1	0 dBm	0.700 V	-10 dBm	0.218 to 0.224 V
x10	-10 dBm	1.800 V	-20 dBm	0.562 to 0.576 V
x10	-20 dBm	0.700 V	-30 dBm	0.218 to 0.224 V
x100	-30 dBm	1.800 V	-40 dBm	0.562 to 0.576 V
x100	-40 dBm	0.700 V	-50 dBm	0.218 to 0.224 V
x1000	-50 dBm	1.800 V	-60 dBm	0.562 to 0.576 V

l. Remove all connections to the SG 505.

5. Check Output Level Step Accuracy (alternative method)

a. Set the SG 505 controls as follows:

FREQUENCY Hz Dial 1
 FREQUENCY Hz
 Pushbutton x 1k
 FREQ VERNIER centered
 OUTPUT LEVEL (dBm) +10
 OUTPUT LEVEL (dBm)
 CAL fully cw
 ON-OFF ON (in)
 GNDED-FLTG FLTG (out)
 INTERMOD TEST SIG
 Pushbutton (opt.) OFF (out)

b. Connect the SG 505 OUTPUT through a coaxial cable to the calibration fixture Input.

c. Connect the calibration fixture Output through an 18 inch coaxial cable to the differential amplifier + input. Set the differential amplifier inputs to dc coupled and not grounded. Set the high frequency 3 dB control to 1 MHz and the low frequency 3 dB control to 0.1 Hz.

d. Connect the differential amplifier Output through a coaxial cable to the oscilloscope differential comparator + input.

e. Set the calibration fixture Mode to Flat (out) and set the Atten to 60 dB (in).

f. Set the vertical amplifier volts/div to 50 mV/div. Set the differential comparator input to gnd and adjust the vertical position control to place the trace on the center horizontal graticule line. Make certain the dc comparison voltage is connected to the - input of the differential comparator via front panel selection and the + input is dc coupled.

g. Set the differential amplifier gain control and pushbutton as listed in the first line of Table 4-4.

h. Set the differential comparator voltage to the first value shown in the table.

i. Adjust the differential comparator variable gain to position the waveform peaks on the oscilloscope display to the center horizontal graticule line.

j. Change the SG 505 OUTPUT LEVEL (dBm) control to the value shown in the table.

k. Adjust the differential comparator voltage to position the waveform peaks on the center horizontal graticule line.

l. CHECK—that the differential comparator voltage is within the limits shown in the table.

m. Repeat step 5 parts g through l for the remaining lines of the table.

Table 4-4

OUTPUT LEVEL STEP ACCURACY CHECK

Differential Amplifier Gain	Differential Amplifier Mode	Differential Comparator Voltage	SG 505 OUTPUT LEVEL (dBm) Control	Differential Comparator Voltage Limits
100	÷ 100	3.200 V	0 dBm	1.000 to 1.024 V
100	÷ 100	1.012 V	-10 dBm	0.316 to 0.324 V
1 K	÷ 100	3.200 V	-20 dBm	1.000 to 1.024 V
1 K	÷ 100	1.012 V	-30 dBm	0.316 to 0.324 V
100	NORM	3.200 V	-40 dBm	1.000 to 1.024 V
100	NORM	1.012 V	-50 dBm	0.316 to 0.324 V
1 K	NORM	3.200 V	-60 dBm	1.000 to 1.024 V

n. Remove all connections to the SG 505.

6. Check Output Level Variable Range

a. Set the SG 505 controls as follows:

FREQUENCY Hz Dial 1
 FREQUENCY Hz
 Pushbutton x 1k
 FREQ VERNIER centered
 OUTPUT LEVEL (dBm) 0
 OUTPUT LEVEL (dBm)
 CAL fully cw
 ON-OFF ON (in)
 GNDED-FLTG GNDED (in)
 INTERMOD TEST SIG
 Pushbutton (Opt.) OFF (out)

b. Connect the SG 505 OUTPUT through a coaxial cable to the calibration fixture Input.

c. Connect the calibration fixture Output through an 18 inch coaxial cable to the rms voltmeter input.

d. Set the calibration fixture Mode to Flat (out) and Atten to 0 dB (out).

e. Turn the SG 505 OUTPUT LEVEL (dBm) CAL control slightly ccw (just out of detent).

f. CHECK—that the rms voltmeter reads ≥ 1.000 V rms.

g. Turn the SG 505 OUTPUT LEVEL (dBm) CAL control fully ccw.

h. CHECK—that the rms voltmeter reads ≤ 0.245 V rms.

i. Leave the connections and control settings and proceed to the next step.

7. Check Level Flatness

Step 8 is an alternative method for checking level flatness. Either step 7 or step 8 may be performed.

a. Change the SG 505 controls as follows:

OUTPUT LEVEL (dBm)
 CAL fully cw

b. Connect the calibration fixture Output through an 18 inch coaxial cable to the wide band rms voltmeter input.

c. Adjust the OUTPUT LEVEL (dBm) CAL control for a voltmeter reading of 0.775 V. Do not change this control position for the rest of step 7.

d. Set the SG 505 FREQUENCY Hz dial and FREQUENCY Hz pushbutton as listed in Table 4-5.

e. CHECK—that the rms voltmeter reading is within the limits listed in Table 4-5.

f. Repeat step 7 parts c through e for the remaining lines of the table.

Table 4-5
LEVEL FLATNESS CHECK

SG 505 FREQUENCY Hz Dial	SG 505 FREQUENCY Hz Pushbutton	Rms Voltmeter Reading Limits
1	x 10	0.765 to 0.784 V rms
2	x 10K	
5	x 10K	0.757 to 0.793 V rms
10	x 10K	

g. Remove all connections to the SG 505.

8. Check Level Flatness (alternative method)

a. Set the SG 505 controls as follows:

FREQUENCY Hz Dial	1
FREQUENCY Hz Pushbutton	x 1k
FREQ VERNIER	centered
OUTPUT LEVEL (dBm)	+10
OUTPUT LEVEL (dBm)	
CAL	fully cw
ON-OFF	ON (in)
GNDED-FLTG	FLTG (out)
INTERMOD TEST SIG Pushbutton (Opt.)	OFF (out)

b. Connect the SG 505 OUTPUT through a coaxial cable to the calibration fixture Input.

c. Connect the calibration fixture Output through an 18 inch coaxial cable to the oscilloscope differential comparator + input.

d. Set the calibration fixture Mode to Flat (out) and set the Atten to -60 dB (in).

e. Set the input coupling to ground and adjust vertical position to place the trace on the center horizontal graticule line. Make certain the dc comparison voltage is connected to the - input of the differential comparator via front panel selection and the + input is dc coupled.

f. Adjust the differential comparator voltage to 1.727 V. Adjust the SG 505 OUTPUT LEVEL (dBm) CAL control to position the waveform peaks on the center horizontal graticule line.

g. Change the SG 505 FREQUENCY Hz dial and pushbutton as listed in Table 4-6.

h. Adjust the differential comparator voltage to reposition the waveform peaks on the center horizontal graticule line.

i. CHECK—that the comparator voltage readout is within the limits listed in Table 4-6 for each frequency setting.

Table 4-6
LEVEL FLATNESS CHECK

SG 505 FREQUENCY Hz		Comparator Voltage Limits
Dial	Pushbutton	
1	x 10	1.707 to 1.747 V
2	x 10	
2	x 10K	
10	x 10K	1.687 to 1.767 V

j. Remove all connections to the SG 505.

9. Check Distortion

NOTE

A complex and lengthy procedure is required to verify the SG 505 ultra-low distortion. Unless there is reason to suspect the SG 505 may not meet its distortion specification because of recent repair or accidental abuse, it is suggested that this procedure be omitted. Distortion can be easily and quickly checked to the residual limits of almost any commercially available distortion or spectrum analyzer.

Performance Check

a. Set the SG 505 controls as follows:

FREQUENCY Hz Dial	1
FREQUENCY Hz	
Pushbutton	x 10
FREQ VERNIER	centered
OUTPUT LEVEL (dBm)	+10
OUTPUT LEVEL (dBm)	
CAL	just out of detent
ON-OFF	ON (in)
GNDED-FLTG	FLTG (out)
INTERMOD TEST SIG	
Pushbutton (Opt.)	OFF (out)

b. Connect the SG 505 OUTPUT through a coaxial cable to the calibration fixture Input. Connect the calibration fixture Output through an 18 inch coaxial cable to the differential amplifier + input. Connect the differential amplifier output through a coaxial cable to L3 input. Connect a 50 Ω termination or short to the differential amplifier - input. Set the differential amplifier gain to 100. Set both input coupling to dc. Set the high frequency 3 dB control to 1 MHz and the low frequency 3 dB control to 0.1 Hz.

c. Set the calibration fixture controls as follows:

NOTCH FREQUENCY	10 Hz
MODE	Flat (out)
ATTEN	-60 dB (in)

d. Set the 7L5 controls as follows:

FREQUENCY	50 Hz/div
RESOLUTION	10 Hz
TIME/DIV	10 sec/div
LOG	10 dB/div
SOURCE MODE	FREE RUN, NORMAL

Set the L3 controls to 1 M Ω , dBv.

e. Set the 7L5 A & B to off and manual sweep. Adjust the 7L5 manual sweep dial to position the dot horizontally in line with the 10 Hz graticule mark (see Fig. 4-1). Adjust the 7L5 Reference level control to position the dot vertically on the top graticule line. This line is the -60 dB reference level

f. Set the calibration fixture Mode to Notch (in) position and the Atten to 0 dB (out). Adjust the SG 505 FREQ VERNIER dial and the calibration fixture Adj For Null controls to position the dot vertically to the most stable point below the -80 dB level on the display. (See Fig. 4-1.) Set the 7L5 A & B to the on position and normal sweep mode.

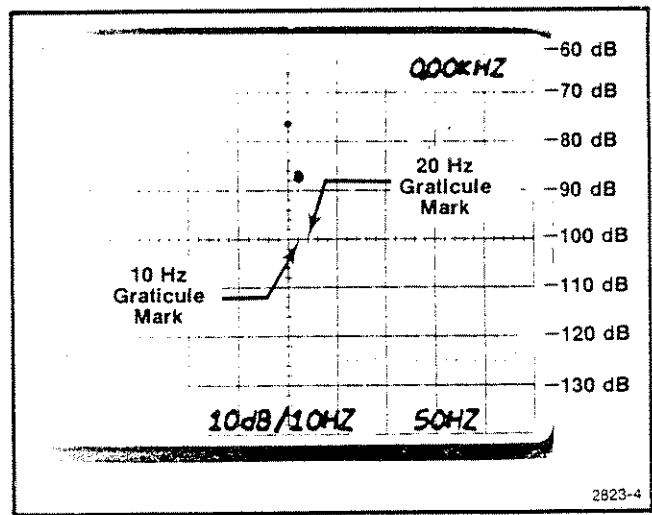

Fig. 4-1. 10 Hz null adjustment.

g. Note the 2nd, 3rd, 4th, and 5th harmonics on the displayed waveform (see Fig. 4-2). If the harmonic amplitudes on either side of the 0 Hz are slightly different, average the two readings for each harmonic.

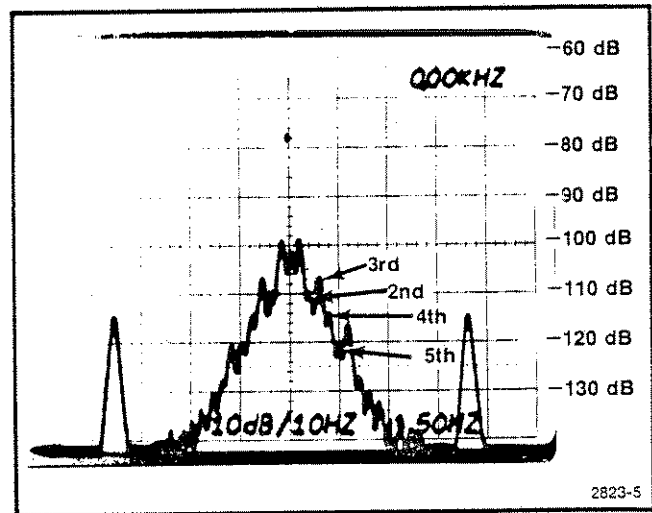

Fig. 4-2. 10 Hz harmonic distortion display.

NOTE

Due to the purely passive nature of the 067-0938-00 Calibration Fixture, the losses at the various harmonics must be taken into account to correct the harmonic values noted on the spectrum analyzer display. The following loss (correction) factors must be added to the displayed values to obtain corrected values.

Table 4-7

HARMONIC CORRECTION FACTORS

Harmonic	Notch Frequency Setting		
	10 Hz to 20 kHz	50 kHz	100 kHz
2nd	9.5	10	10.5
3rd	6.0	6.5	7
4th	4.5	5	5.5
5th	3.5	4	4.5

h. Compute the total harmonic distortion (thd) using the harmonic values noted and either of the two following methods.

Formula Method for Computing thd:

Substitute the harmonic values (in dB), noted in step 9 part g, in the following formula:

$$\text{thd} = 20 \times \log_{10} A$$

$$\sqrt{10^{(2\text{nd} + 9.5)/10} + 10^{(3\text{rd} + 6)/10} + 10^{(4\text{th} + 4.5)/10} + 10^{(5\text{th} + 3.5)/10}}$$

The numbers added to the harmonic values in the formula are correction factors for the calibration fixture at 10 Hz Notch Frequency.

h. For example, using the harmonic distortion levels in Fig. 4-2 and the corrections factors in the previous formula:

$$\begin{aligned} 2\text{nd harmonic} &= -110 \text{ dB} + 9.5 = -100.5 \\ 3\text{rd harmonic} &= -107 \text{ dB} + 6 = -101 \\ 4\text{th harmonic} &= -115 \text{ dB} + 4.5 = -110.5 \\ 5\text{th harmonic} &= -121 \text{ dB} + 3.5 = -117.5 \end{aligned}$$

dividing by 10 and raising 10 to this power gives:

$$\begin{aligned} -100.5 \div 10 &= -10.05 \quad 10^{-10.05} = 89.12 \times 10^{-12} \\ -101 \div 10 &= -10.1 \quad 10^{-10.1} = 79.43 \times 10^{-12} \\ -110.5 \div 10 &= -11.05 \quad 10^{-11.05} = 8.91 \times 10^{-12} \\ -117.5 \div 10 &= -11.75 \quad 10^{-11.75} = 1.77 \times 10^{-12} \\ &= 179.2 \times 10^{-12} \end{aligned}$$

taking the square root results in:

$$\sqrt{179.2 \times 10^{-12}} = 1.34 \times 10^{-5}$$

taking the log:

$$\log_{10} 1.34 \times 10^{-5} = -4.87$$

multiplying by 20:

$$-4.87 \times 20 = -97.46 \text{ dB thd}$$

Table Method for Computing thd:

Add the calibration fixture correction factors to the harmonic distortion levels noted in step 9 part g. For example, using the harmonic distortion levels in Fig. 4-2 and the calibration fixture correction factors for 10 Hz Notch Frequency.

$$\begin{aligned} 2\text{nd harmonic} &= -110 \text{ dB} + 9.5 = -100.5 \\ 3\text{rd harmonic} &= -107 \text{ dB} + 6 = -101 \\ 4\text{th harmonic} &= -115 \text{ dB} + 4.5 = -110.5 \\ 5\text{th harmonic} &= -121 \text{ dB} + 3.5 = -117.5 \end{aligned}$$

Compute the arithmetic difference between the two numerically lower dB values—in this case, -100.5 and -101. Locate this difference value (0.5) in Table 4-8. If the difference value falls between two of the difference values in the table, interpolate the corresponding value in the Additive Factor column. Algebraically add the number in the Additive Factor column (2.77) to the numerically lower dB value:

$$\begin{aligned} &-100.50 \\ &\quad \underline{2.77} \\ &-97.73 \end{aligned}$$

Now repeat the process (find the arithmetic difference) using the resulting number (-97.73) and the next numerically lower dB value:

$$\begin{aligned} &-110.50 \\ &\quad \underline{-97.73} \\ &\quad \quad \underline{12.77} \end{aligned}$$

The value opposite 12.77 in Table 4-8 is approximately 0.23. Algebraically adding 0.23 to -97.73 = -97.50. Repeat the process using -97.50 and the remaining dB value to the combined, -117.5:

$$\begin{aligned} &-117.5 \\ &\quad \underline{-97.50} \\ &\quad \quad \underline{20.00} \end{aligned}$$

The value opposite 20.00 in the table is approximately 0.04.

$$\begin{aligned} &-97.50 \\ &\quad \underline{0.04} \\ &\quad \underline{-97.46} = \text{thd} \end{aligned}$$

Table 4-8

FACTORS FOR THD COMPUTATION

Difference Value	Additive Factor
0.0	3.01
0.5	2.77
1.0	2.54
2.0	2.12
3.0	1.76
4.0	1.46
5.0	1.19
6.0	0.97
7.0	0.79
8.0	0.64
9.0	0.51
10.0	0.41
11.0	0.33
12.0	0.27
13.0	0.21
14.0	0.17
15.0	0.14
16.0	0.11
17.0	0.09
18.0	0.07
19.0	0.05
20.0	0.04

- i. CHECK— that the calculated thd is less than -95 dB.
- j. Change the SG 505 FREQUENCY Hz dial to 2. Change the calibration fixture Notch Frequency to 20 Hz.

NOTE

Due to the microvolt nature of the SG 505's distortion products, their measurement is somewhat susceptible to interference from external magnetic fields. This is particularly true at the third harmonic of 20 Hz, where care should be exercised to avoid confusion with or interference from 60 Hz components. In particular, it may be necessary to move the calibration fixture (067-0938-00) away from stray magnetic fields (transformers).

- k. Repeat step 9 parts e through h using the 20 Hz graticule mark on the display for step 9 part e (see Fig. 4-1).

- l. CHECK— that the calculated thd is less than -102 dB (see Fig. 4-3 for harmonics at 20 Hz).

- m. Set the SG 505 FREQUENCY Hz pushbutton to 10 kHz (in). Change the calibration fixture Notch Frequency to 20 kHz.

- n. Set the calibration fixture Mode to Flat (out) and the Atten to -60 dB (in) position. Change the 7L5 to 10 kHz/div and 0.1 sec/div. Remove the differential amplifier and connect the calibration fixture output through the 18 inch coaxial cable to the 7L5/L3 input.

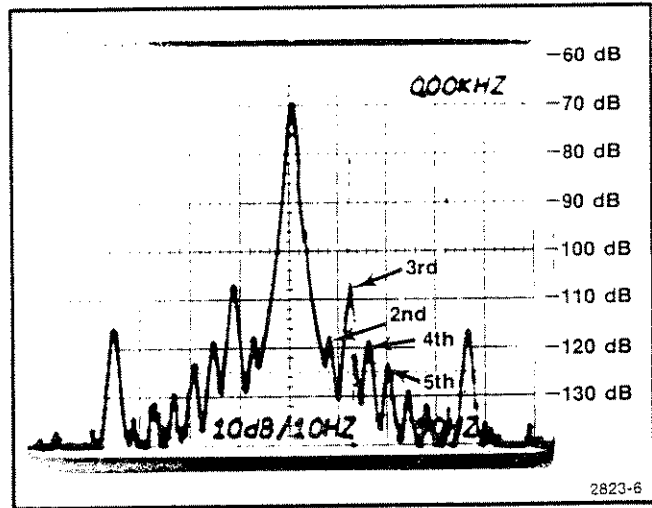

Fig. 4-3. 20 Hz harmonic distortion display.

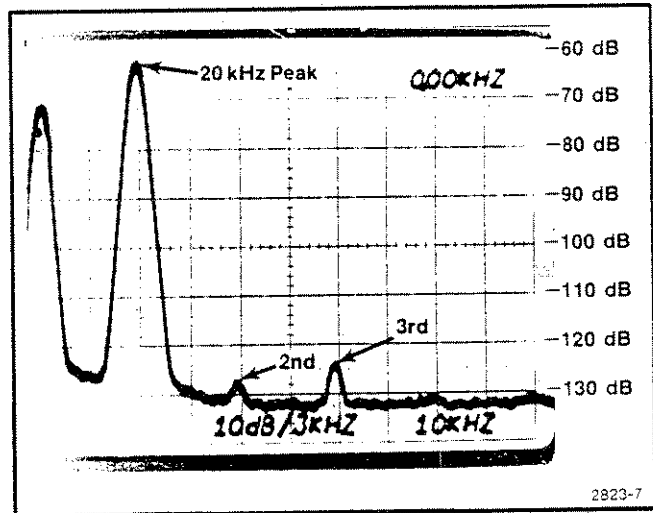

Fig. 4-4. 20 kHz harmonic distortion display.

- o. Adjust the 7L5 reference level control to position the 20 kHz peak on the top horizontal graticule line. This line is the -60 dB reference level (see Fig. 4-4).

- p. Set the calibration fixture Mode to Notch (in) and Atten to 0 dB (out). Adjust the SG 505 FREQ VERNIER control and the two calibration fixture Adjust For Null controls to position the 20 kHz peak below the top horizontal graticule line (see Fig. 4-4).

- q. Note the 2nd, 3rd, 4th, and 5th harmonics on the waveform, or as many of these harmonics as are visible. See Fig. 4-4 and compute the thd using the formula in step 9 part h.

r. CHECK—that the calculated thd is less than -102 dB.

s. Set the SG 505 FREQUENCY Hz dial to 5. Change the calibration fixture Notch Frequency to 50 kHz.

t. Repeat step 9 parts n through q, except position the 50 kHz peak (2nd peak) of the waveform (see Fig. 4-4).

NOTE

The loss (correction) factors for the 067-0938-00 Calibration Fixture at the 50 kHz and 100 kHz frequencies are slightly different from the correction factors for the lower frequencies (see Table 4-7).

u. CHECK—that the calculated thd is less than -95 dB.

v. Set the SG 505 FREQUENCY Hz dial to 10. Change the calibration fixture Notch Frequency to 100 kHz.

w. Repeat step 9 parts n through q, except position the 100 kHz peak (2nd peak) of the waveform. The waveform is similar to that in Fig. 4-4.

x. CHECK—that the calculated thd is less than -90 dB.

y. Remove all connections to the SG 505.

10. Check Output Impedance

a. Set the SG 505 controls as follows:

FREQUENCY Hz Dial	1
FREQUENCY Hz	
Pushbutton	x 1k
FREQ VERNIER	centered
OUTPUT LEVEL (dBm)	0
OUTPUT LEVEL (dBm)	
CAL	fully cw
ON-OFF	ON (in)
GNDED-FLTG	GNDED (in)
INTERMOD TEST SIG	
Pushbutton (Opt.)	OFF (out)

b. Connect the SG 505 OUTPUT through a T-adaptor and two coaxial cables to the rms voltmeter input.

c. Adjust the SG 505 OUTPUT LEVEL (dBm) CAL control for a voltmeter reading of 1.800 V.

d. Set the calibration fixture Mode to Flat (out) and Atten to 0 dB (out).

e. Connect the T-adaptor to the calibration fixture Input.

f. CHECK—that the voltmeter reading is between 0.891 and 0.909 V rms.

g. Remove all connections to the SG 505.

11. Check Sync Out Amplitude

a. Set the SG 505 controls as follows:

FREQUENCY Hz Dial	1
FREQUENCY Hz	
Pushbutton	x 1k
FREQ VERNIER	centered
OUTPUT LEVEL (dBm)	0
OUTPUT LEVEL (dBm)	
CAL	fully cw
ON-OFF	ON (in)
GNDED-FLTG	GNDED (in)
INTERMOD TEST SIG	
Pushbutton (Opt.)	OFF (out)

b. Connect the SG 505 SYNC OUT through a coaxial cable to the rms voltmeter input.

c. CHECK—that the voltmeter reads between 0.160 and 0.240 V rms.

d. Remove all connections to the SG 505.

12. Check Intermodulation Test Signal Ratio (Option 01)

a. Set the SG 505 controls as follows:

FREQUENCY Hz Dial	7
FREQUENCY Hz	
Pushbutton	x 1k
FREQ VERNIER	centered
OUTPUT LEVEL (dBm)	0
OUTPUT LEVEL (dBm)	
CAL	fully cw
ON-OFF	ON (in)
GNDED-FLTG	FLTG (out)
INTERMOD TEST SIG	
Pushbutton (Opt.)	OFF (out)

**Calibration Procedure—SG 505
Performance Check**

b. Connect the SG 505 OUTPUT through a coaxial cable to the oscilloscope vertical input.

c. Set the oscilloscope vertical sensitivity to 1 V/div.

d. Adjust the SG 505 OUTPUT LEVEL (dBm) CAL control and the oscilloscope vertical gain for a 5 V p-p display.

e. Set the SG 505 INTERMOD TEST SIG pushbutton on (in).

f. CHECK—that the amplitude of the composite signal on the display is between 4.89 and 5.12 divisions, peak-to-peak.

g. Adjust the SG 505 OUTPUT LEVEL (dBm) CAL control for a vertical trace width (high frequency portion of this waveform) one division in amplitude.

h. CHECK—that the vertical distance from the top of the lowest portion of the composite trace to the upper peak level of this trace is 3.9 to 4.1 divisions high. (4:1 Ratio).

i. Remove all connections to the SG 505.

13. Check Intermodulation Test Signal Frequency (Option 01)

a. Determine the low frequency of the intermodulation test signal.

b. Connect the SYNC OUT through a coaxial cable to the counter input.

c. Set the counter to 0.1 Hz resolution.

d. CHECK—that the counter reads between 58.8 and 61.2 Hz if the low frequency is 60 Hz or between 245 and 255 Hz if the low frequency is 250 Hz.

e. Remove all connections to the SG 505.

This completes the Performance Check procedure for the SG 505.

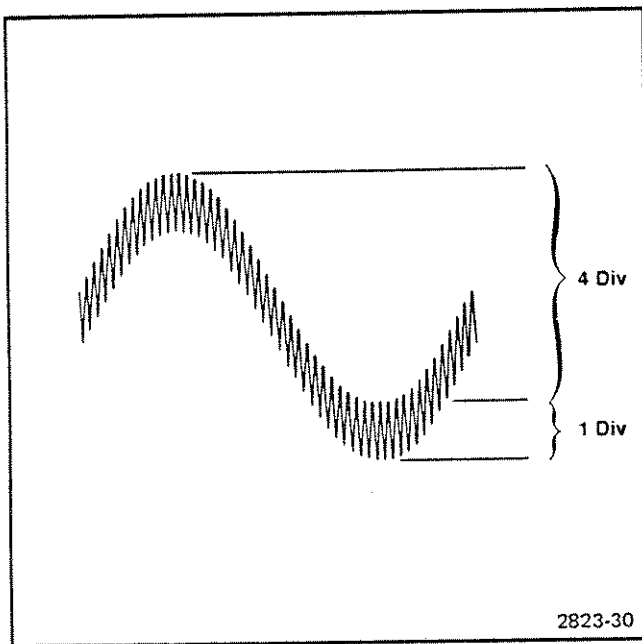

Fig. 4-4A. 4:1 Ratio.

ADJUSTMENTS

Introduction

This procedure need not be performed unless the instrument fails to meet the performance requirements of the electrical characteristics listed in the Specification section of this manual. To ensure instrument accuracy, perform the adjustment of the instrument every 1000 hours of operation or every six months if used infrequently. Adjustment may be required after a repair has been made. If adjustment of internal controls does not bring the instrument performance within the limits listed in the Specification section, troubleshooting is indicated. Adjustments should be made with the instrument operating at an ambient temperature of 20°C to 30°C.

Test Equipment Required

Test equipment used for adjustment of the SG 505 is listed at the beginning of the Calibration section of this manual.

Preparation

To gain access to the adjustable components, remove the left side cover of the SG 505 by pulling the rear of the side cover outward from the instrument. Adjustment locations are shown in the adjustment locations illustration located in the pullout pages in the rear of this manual.

Connect the SG 505 to the power module via the extender cable. Connect the test equipment and the power module to a suitable line voltage source. Turn on the power module and test equipment; allow at least 30 minutes warm-up time for the SG 505.

b. Connect the SG 505 SYNC OUT through a coaxial cable to the counter Input. Set the counter for 1 Hz resolution.

c. CHECK/ADJUST—the SG 505 frequency for 4,000 kHz as follows: Loosen internal set screw #1 located on the reduction drive shaft of the FREQUENCY Hz potentiometer assembly R530 and R520 (see Fig. 4-5). Position the FREQUENCY Hz dial to 4. Loosen set screw #2 and turn the potentiometer shaft with pliers until the counter reading is 4,000 kHz. Tighten set screw #2 without moving the FREQUENCY Hz dial. Turn the FREQUENCY Hz dial to gain access to set screw #1 and tighten.

d. Remove all connections to the SG 505.

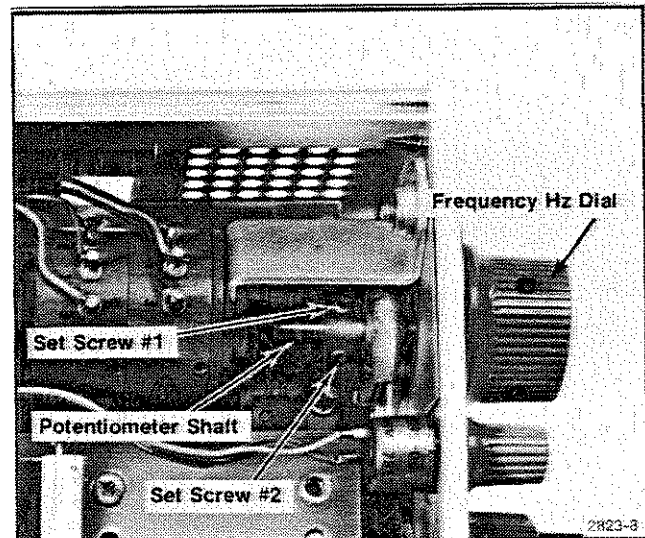

Fig. 4-5. Left side view of SG 505.

PROCEDURE

1. Adjust Frequency Hz Dial

a. Set the SG 505 controls as follows:

FREQUENCY Hz Dial	4
FREQUENCY Hz Pushbutton	x 1k
FREQ VERNIER	centered
OUTPUT LEVEL (dBm)	0
OUTPUT LEVEL (dBm) CAL	fully cw
ON-OFF	ON (in)
GNDED-FLTG	FLTG (out)
INTERMOD TEST SIG Pushbutton (Opt.)	OFF (out)

2. Adjust Output Level Amplitude

a. Set the SG 505 controls as follows:

FREQUENCY Hz Dial	1
FREQUENCY Hz Pushbutton	x 1k
FREQ VERNIER	centered
OUTPUT LEVEL (dBm)	0
OUTPUT LEVEL (dBm) CAL	fully cw
ON-OFF	ON (in)
GNDED-FLTG	FLTG (out)
INTERMOD TEST SIG Pushbutton (Opt.)	OFF (out)

**Calibration Procedure—SG 505
Adjustments**

b. Connect the SG 505 OUTPUT through a coaxial cable to the calibration fixture Input.

c. Connect the calibration fixture Output through an 18 inch coaxial cable to the rms voltmeter input.

d. Set the calibration fixture Mode to Flat (out) and Atten to 0 dB (out).

e. CHECK/ADJUST—A10 R1423, 0 dBm Adj, for a voltmeter reading of 0.775 V rms.

f. Remove all connections to the SG 505.

3. Adjust Sync Out Amplitude

a. Set the SG 505 controls as follows:

FREQUENCY Hz Dial	1
FREQUENCY Hz	
Pushbutton	x 1k
FREQ VERNIER	centered
OUTPUT LEVEL (dBm)	0
OUTPUT LEVEL (dBm)	
CAL	fully cw
ON-OFF	ON (in)
GNDED-FLTG	FLTG (out)
INTERMOD TEST SIG	
Pushbutton (Opt.)	OFF (out)

b. Connect the SG 505 SYNC OUT through a coaxial cable to the rms voltmeter.

c. CHECK/ADJUST—A10 R1301, Sync Level Adj, for a voltmeter reading of 0.2 V rms.

d. Remove all connections to the SG 505.

**4. Adjust Intermodulation Test Signal Ratio
(Option 01)**

a. Set the SG 505 controls as follows:

FREQUENCY Hz Dial	7
FREQUENCY Hz	
Pushbutton	x 1k
FREQ VERNIER	centered
OUTPUT LEVEL (dBm)	0
OUTPUT LEVEL (dBm)	
CAL	fully cw
ON-OFF	ON (in)
GNDED-FLTG	FLTG (out)
INTERMOD TEST SIG	
Pushbutton (Opt.)	OFF (out)

b. Connect the SG 505 OUTPUT through a coaxial cable to the oscilloscope vertical input.

c. Set the oscilloscope vertical sensitivity to 1 V/div.

d. Rotate the SG 505 OUTPUT LEVEL (dBm) CAL control and the oscilloscope vertical position for a 5 V p-p display.

e. Set the SG 505 INTERMOD TEST SIG to ON (in).

f. CHECK/ADJUST—A11 R1211, Imd Ratio Adj, so the composite signal amplitude is 5 divisions, peak-to-peak.

g. Remove all connections to the SG 505.

This completes the Adjustments procedure for the SG 505.

MAINTENANCE

Recalibration

To ensure accurate measurements, check the calibration of this instrument after each 1000 hours of operation or every six months if used infrequently. In addition, replacement of components may necessitate recalibration of the affected circuits. Complete adjustment instructions are given in the Calibration section.

Tektronix, Inc. provides complete instrument repair and calibration at local Field Service Centers and at the Factory Service Center. Contact your local Tektronix Field Office or representative for further information.

Obtaining Replacement Parts

Most electrical and mechanical parts can be ordered through your local Tektronix Field Office or representative. However, you should be able to obtain many of the standard electronic components from a local commercial source in your area. Before you purchase or order a part from a source other than Tektronix, Inc., please check the electrical parts list for the proper value, rating, tolerance, and description.

Ordering Parts. When ordering replacement parts from Tektronix, Inc., it is important that all of the following information be included to ensure receiving the proper parts.

1. Instrument type (include modification or option numbers).
2. Instrument serial number.
3. A description of the part (if electrical, include circuit and assembly numbers).
4. Tektronix part number.

Cleaning Instructions

This instrument should be cleaned as often as operating conditions require. Accumulation of dirt on components acts as an insulating blanket and prevents efficient heat dissipation, which can cause overheating and component breakdown.

Exterior

Loose dust accumulated on the front panel can be removed with a soft cloth or a small brush. Dirt that remains can be removed with a soft cloth dampened with a mild detergent and water solution. Abrasive cleaners should not be used.

CAUTION

To prevent getting water inside the instrument during external cleaning, use only enough water to dampen the cloth or swab.

DO NOT use chemical cleaning agents as they may damage the plastics used in the instrument. In particular, avoid chemicals that contain benzene, toluene, xylene, acetone or similar solvents.

Interior

Dust in the interior of the instrument should be removed occasionally due to its electrical conductivity under high humidity conditions. The best way to clean the interior is to blow off the accumulated dust with dry, low pressure air. Then use a soft brush.

Isopropyl alcohol can be used to clean major repairs to the circuit board; however, flush the board well with clean, isopropyl alcohol. Make certain that resin or dirt is carefully removed from board areas of high impedance circuitry.

Circuit Board Removal and Installation

Remove the two snap-in side covers by pulling out on the rear of each side cover.

For an Option 01 SG 505, remove the IMD board (Assy A11) as follows:

Remove the INTERMOD TEST SIG pushbutton shaft by spreading the ends of the shaft attached to the pushbutton and pulling the shaft forward. Remove the two screws located to the left rear and to the right front on top of OUTPUT LEVEL switch S1710. Disconnect the two multi-pin connectors attached to the IMD board. Lift the board up and out.

Remove the oscillator board (Assy A10) as follows:

1. Disconnect the multi-pin connector (P1500) from the FREQUENCY Hz potentiometer assembly (R520 and R530) to the oscillator board. Loosen the two set screws located on the reduction drive shaft. Using a 5/16" open end wrench, remove the nut that holds the potentiometer to the metal bracket.

2. Loosen the two set screws in the OUTPUT LEVEL (dBm) and OUTPUT LEVEL (dBm) CAL knobs and remove the knobs. Remove the nut and washer on the OUTPUT LEVEL shaft.

3. Disconnect the multi-pin connector (P1510) that connects the FREQ VERNIER potentiometer (R510) to the oscillator board.

4. Carefully unsolder, at the oscillator board, the two connections from OUTPUT connector J540. Also unsolder the connection from the SYNC OUT connector (J550) at the oscillator board.

5. On the back of the oscillator board, carefully pull out the socket holding the POWER LED (DS510).

6. Remove the two guide screws and the two Phillips screws on the rear metal frame and remove the frame.

7. Remove the four screws holding the oscillator board to the side panels.

8. Carefully slide the oscillator board toward the rear of the instrument.

To reassemble the instrument, reverse the above procedure. After placing the oscillator board within the chassis side panels, position the two plastic circuit board guides approximately midway on each side of the oscillator board. Make certain the circuit board guides do not contact components or component leads. After instrument reassembly, perform the Frequency Hz Dial adjustment (Step 1 in the Adjustments procedure), to calibrate the reduction drive and knob position to the FREQUENCY Hz potentiometer shaft position.

Low Frequency Selection (Option 01)

The SG 505 Option 01 instrument contains an internal jumper (P1100) that may be positioned to select either a 60 Hz or 250 Hz low frequency in the intermodulation test signal mode. The jumper is located toward the rear of the IMD Option board (Assy. A11). When the jumper is

positioned on the two pins marked 60 Hz (A11 J1102), the low frequency is 60 Hz. If the jumper is placed on the four pins marked 250 Hz (A11 J1100), the low frequency is 250 Hz.

Troubleshooting Aids

Troubleshooting Charts. As an aid in locating problem areas, troubleshooting charts are provided for the SG 505. These charts are located in the foldout pages in the Diagrams and Illustrations section. The numbered diamond by the troubleshooting chart title refers to the corresponding schematic diagram number.

Diagrams. Complete circuit diagrams are located in the foldout pages in the Diagrams and Illustrations section. The portions of the circuit mounted on circuit boards are enclosed by a solid line. The circuit number of each component in this instrument is shown on a diagram. See the first page of the Diagrams and Illustrations section for definitions of the symbols and reference designators used on the diagrams.

Circuit Board Illustrations. In conjunction with each circuit diagram is a circuit board illustration. Each component shown on a diagram is also identified on the circuit board illustration by its circuit number. A table is provided with each diagram listing components by assembly and circuit number. The table also lists the component grid locations on both the diagram and circuit board illustrations.

Adjustment Locations Illustration. To aid in locating test points and adjustable components, the adjustment locations pullout page (normally used with the Adjustment procedure) permits rapid location of test points and adjustments.

Troubleshooting Equipment

Before using any test equipment to make measurements on static sensitive components or assemblies, be certain that any voltage or current supplied by the test equipment does not exceed the limits of the component to be tested.

Static-Sensitive Components



Static discharge can damage any semiconductor component in this instrument.

This instrument contains electrical components that are susceptible to damage from static discharge. See

Table 5-1 for relative susceptibility of various classes of semiconductors. Static voltages of 1 kV to 30 kV are common in unprotected environments.

Observe the following precautions to avoid damage:

1. Minimize handling of static-sensitive components.
2. Transport and store static-sensitive components or assemblies in their original containers, on a metal rail, or on conductive foam. Label any package that contains static-sensitive assemblies or components.
3. Discharge the static voltage from your body by wearing a wrist strap while handling these components. Servicing static-sensitive assemblies or components should be performed only a static-free work station by qualified service personnel.
4. Nothing capable of generating or holding a static charge should be allowed on the work station surface.
5. Keep the component leads shorted together whenever possible.
6. Pick up components by the body, never by the leads.
7. Do not slide the components over any surface.
8. Avoid handling components in areas that have a floor or work-surface covering capable of generating a static charge.
9. Use a soldering iron that is connected to earth ground.

10. Use only special antistatic suction type or wick type desoldering tools.

Table 5-1
RELATIVE SUSCEPTIBILITY TO
STATIC DISCHARGE DAMAGE

Semiconductor Classes	Relative Susceptibility Levels ^a
MOS or CMOS microcircuits or discretes, or linear microcircuits with MOS inputs. (Most Sensitive)	1
ECL	2
Schottky signal diodes	3
Schottky TTL	4
High-frequency bipolar transistors	5
JFETs	6
Linear microcircuits	7
Low-power Schottky TTL	8
TTL (Least Sensitive)	9

^a Voltage equivalent for levels:

- | | | |
|------------------|------------------|--------------------------|
| 1 = 100 to 500 V | 4 = 500 V | 7 = 400 to 1000 V (est.) |
| 2 = 200 to 500 V | 5 = 400 to 600 V | 8 = 900 V |
| 3 = 250 V | 6 = 600 to 800 V | 9 = 1200 V |
- (Voltage discharged from a 100 pF capacitor through a resistance of 100 ohms.)

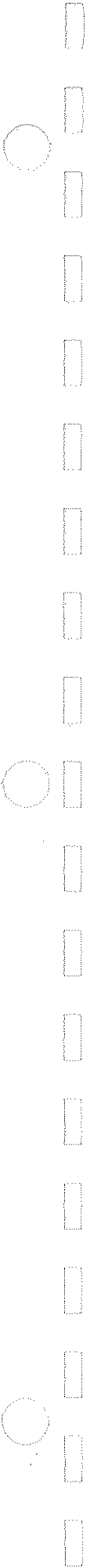

OPTIONS

The information in this manual describes only the Option 01 version of the SG 505 Oscillator. A separate instruction manual is available which contains information for both the standard and Option 02 SG 505 Oscillator.



REPLACEABLE ELECTRICAL PARTS

PARTS ORDERING INFORMATION

Replacement parts are available from or through your local Tektronix, Inc. Field Office or representative.

Changes to Tektronix instruments are sometimes made to accommodate improved components as they become available, and to give you the benefit of the latest circuit improvements developed in our engineering department. It is therefore important, when ordering parts, to include the following information in your order: Part number, instrument type or number, serial number, and modification number if applicable.

If a part you have ordered has been replaced with a new or improved part, your local Tektronix, Inc. Field Office or representative will contact you concerning any change in part number.

Change information, if any, is located at the rear of this manual.

SPECIAL NOTES AND SYMBOLS

X000 Part first added at this serial number

00X Part removed after this serial number

ITEM NAME

In the Parts List, an Item Name is separated from the description by a colon (:). Because of space limitations, an Item Name may sometimes appear as incomplete. For further Item Name identification, the U.S. Federal Cataloging Handbook H6-1 can be utilized where possible.

ABBREVIATIONS

ACTR	ACTUATOR	PLSTC	PLASTIC
ASSY	ASSEMBLY	QTZ	QUARTZ
CAP	CAPACITOR	RECP	RECEPTACLE
CER	CERAMIC	RES	RESISTOR
CKT	CIRCUIT	RF	RADIO FREQUENCY
COMP	COMPOSITION	SEL	SELECTED
CONN	CONNECTOR	SEMICOND	SEMICONDUCTOR
ELCTLT	ELECTROLYTIC	SENS	SENSITIVE
ELEC	ELECTRICAL	VAR	VARIABLE
INCAND	INCANDESCENT	WW	WIREWOUND
LED	LIGHT EMITTING DIODE	XFMR	TRANSFORMER
NONWIR	NON WIREWOUND	XTAL	CRYSTAL

CROSS INDEX - MFR. CODE NUMBER TO MANUFACTURER

Mfr. Code	Manufacturer	Address	City, State, Zip Code
00853	SANGAMO WESTON INC	SANGAMO RD	PICKENS SC 29671
01121	SANGAMO CAPACITOR DIV	P O BOX 128	
01295	ALLEN-BRADLEY CO	1201 SOUTH 2ND ST	MILWAUKEE WI 53204
02111	TEXAS INSTRUMENTS INC	13500 N CENTRAL EXPRESSWAY	DALLAS TX 75265
	SEMICONDUCTOR GROUP	P O BOX 225012 M/S 49	
03508	SPECTROL ELECTRONICS CORP	17070 E GALE AVE	CITY OF INDUSTRY CA 91749
	SUB OF CARRIER CORP	P O BOX 1220	
04222	GENERAL ELECTRIC CO	W GENESEE ST	AUBURN NY 13021
	SEMI-CONDUCTOR PRODUCTS DEPT		
04713	AVX CERAMICS DIV OF AVX CORP	19TH AVE SOUTH	MYRTLE BEACH SC 29577
		P O BOX 867	
05397	MOTOROLA INC	5005 E MCDOWELL RD	PHOENIX AZ 85008
	SEMICONDUCTOR GROUP		
07716	UNION CARBIDE CORP MATERIALS SYSTEMS DIV	11901 MADISON AVE	CLEVELAND OH 44101
08806	TRM INC	2850 MT PLEASANT AVE	BURLINGTON IA 52601
	TRM ELECTRONICS COMPONENTS		
09019	TRM IRC FIXED RESISTORS/BURLINGTON	NELA PK	CLEVELAND OH 44112
	GENERAL ELECTRIC CO		
13511	MINIATURE LAMP PRODUCTS DEPT	ELECTRONICS PARK	SYRACUSE NY 13201
14752	GENERAL ELECTRIC CO		
14936	SEMI-CONDUCTOR PRODUCTS DEPT		
19701	OPERATIONAL PLANNING AND CUSTOMER ENGINEERING		
22526	AMPHENOL CADRE DIV BUNKER RAMO CORP	1710 S DEL MAR AVE	LOS GATOS CA
24546	ELECTRO CUBE INC	600 W JOHN ST	SAN GABRIEL CA 91776
24931	GENERAL INSTRUMENT CORP		HICKSVILLE NY 11802
27014	DISCRETE SEMI CONDUCTOR DIV	P O BOX 760	MINERAL WELLS TX 76067
31433	MPCO/ELECTRA INC		
32997	A NORTH AMERICAN PHILIPS CO	30 HUNTER LANE	CAMP HILL PA 17011
54473	DU PONT E I DE NEMOURS AND CO INC	550 HIGH ST	BRADFORD PA 16701
55680	DU PONT CONNECTOR SYSTEMS	2620 ENDRESS PLACE	GREENWOOD IN 46142
56289	CORNING GLASS WORKS	P O BOX D	
57668	SPECIALTY CONNECTOR CO INC	2900 SEMICONDUCTOR DR	SANTA CLARA CA 95051
58361	NATIONAL SEMICONDUCTOR CORP	PO BOX 5928	GREENVILLE SC 29606
59821	UNION CARBIDE CORP		
71400	ELECTRONICS DIV	1200 COLUMBIA AVE	RIVERSIDE CA 92507
80009	BOURNS INC		
TK1483	TRIMPOT DIV		
	MATSUSHITA ELECTRIC CORP OF AMERICA	ONE PANASONIC WAY	SECAUCUS NJ 07094
	NICHICON /AMERICA/ CORP	927 E STATE PKY	SCHAUMBURG IL 60195
	SPRAGUE ELECTRIC CO	87 MARSHALL ST	NORTH ADAMS MA 01247
	ROHM CORP	16931 WILLIKEN AVE	IRVINE CA 92713
	GENERAL INSTRUMENT CORP	3400 HILLVIEW AVE	PALO ALTO CA 94304
	OPTOELECTRONICS DIV		
	CENTRALAB INC	7158 MERCHANT AVE	EL PASO TX 79915
	SUB NORTH AMERICAN PHILIPS CORP		
	BUSSMANN MFG CO	114 OLD STATE RD	ST LOUIS MO 63178
	MCGRAW EDISON CO	PO BOX 14460	
	TEKTRONIX INC	4900 S W GRIFFITH DR	BEAVERTON OR 97077
		P O BOX 500	
		45 SALEM ST	PROVIDENCE RI 02907

Component No.	Tektronix Part No.	Serial/Assembly No. Effective	Dscont	Name & Description	Mfr. Code	Mfr. Part No.
A10	670-6337-02	8010100	8052439	CIRCUIT 80 ASSY:OSC (STANDARD ONLY)	80009	670-6337-02
A10	670-6337-03	8052440	8052740	CIRCUIT 80 ASSY:OSC (STANDARD ONLY)	80009	670-6337-03
A10	670-6337-04	8052741		CIRCUIT 80 ASSY:OSC (STANDARD ONLY)	80009	670-6337-04
A10	670-6338-02	8010100	8052429	CIRCUIT 80 ASSY:OSC (OPTION 01 ONLY)	80009	670-6338-02
A10	670-6338-03	8052430	8052740	CIRCUIT 80 ASSY:OSC (OPTION 01 ONLY)	80009	670-6338-03
A10	670-6338-04	8052741		CIRCUIT 80 ASSY:OSC (OPTION 01 ONLY)	80009	670-6338-04
A11	670-6339-00			CIRCUIT 80 ASSY:IMD (OPTION 01 ONLY)	80009	670-6339-00
A10	670-6337-02	8010100	8052439	CIRCUIT 80 ASSY:OSC (STANDARD ONLY)	80009	670-6337-02
A10	670-6337-03	8052440	8052740	CIRCUIT 80 ASSY:OSC (STANDARD ONLY)	80009	670-6337-03
A10	670-6337-04	8052741		CIRCUIT 80 ASSY:OSC (STANDARD ONLY)	80009	670-6337-04
A10	670-6338-02	8010100	8052429	CIRCUIT 80 ASSY:OSC (OPTION 01 ONLY)	80009	670-6338-02
A10	670-6338-03	8052430	8052740	CIRCUIT 80 ASSY:OSC (OPTION 01 ONLY)	80009	670-6338-03
A10	670-6338-04	8052741		CIRCUIT 80 ASSY:OSC (OPTION 01 ONLY)	80009	670-6338-04
A10C1100	281-0775-00			CAP, FXD, CER 01:0.1UF, 20%, 50V	04222	MA205E104MAA
A10C1101	290-0525-00			CAP, FXD, ELCTLT:4.7UF, 20%, 50V	05397	T368B475M050AAS
A10C1200	290-0721-00	8010100	8031979	CAP, FXD, ELCTLT:100UF, 20%, 20V (STANDARD ONLY)	56289	196D107X0020TE3
A10C1200	290-0770-00	8031980		CAP, FXD, ELCTLT:100UF, +50-10%, 25VDC (STANDARD ONLY)	54473	ECE-A25V100L
A10C1200	290-0721-00	8010100	8032089	CAP, FXD, ELCTLT:100UF, 20%, 20V (OPTION 01 ONLY)	56289	196D107X0020TE3
A10C1200	290-0770-00	8032090		CAP, FXD, ELCTLT:100UF, +50-10%, 25VDC (OPTION 01 ONLY)	54473	ECE-A25V100L
A10C1201	290-0721-00	8010100	8031979	CAP, FXD, ELCTLT:100UF, 20%, 20V (STANDARD ONLY)	56289	196D107X0020TE3
A10C1201	290-0770-00	8031980		CAP, FXD, ELCTLT:100UF, +50-10%, 25VDC (STANDARD ONLY)	54473	ECE-A25V100L
A10C1201	290-0721-00	8010100	8032089	CAP, FXD, ELCTLT:100UF, 20%, 20V (OPTION 01 ONLY)	56289	196D107X0020TE3
A10C1201	290-0770-00	8032090		CAP, FXD, ELCTLT:100UF, +50-10%, 25VDC (OPTION 01 ONLY)	54473	ECE-A25V100L
A10C1202	290-0724-00	8010100	8031979	CAP, FXD, ELCTLT:330UF, 20%, 6V (STANDARD ONLY)	56289	196D337X0006TE3
A10C1202	290-0771-00	8031980		CAP, FXD, ELCTLT:220UF, +50-10%, 10VDC (STANDARD ONLY)	55680	ULB1A221TPAANA
A10C1202	290-0724-00	8010100	8032089	CAP, FXD, ELCTLT:330UF, 20%, 6V (OPTION 01 ONLY)	56289	196D337X0006TE3
A10C1202	290-0771-00	8032090		CAP, FXD, ELCTLT:220UF, +50-10%, 10VDC (OPTION 01 ONLY)	55680	ULB1A221TPAANA
A10C1203	290-0534-00	8010100	8031979	CAP, FXD, ELCTLT:1UF, 20%, 35V (STANDARD ONLY)	05397	T368A105M035AZ
A10C1203	290-0920-00	8031980		CAP, FXD, ELCTLT:33UF, +50-10%, 35V (STANDARD ONLY)	55680	ULB1V330TEAANA
A10C1203	290-0534-00	8010100	8032089	CAP, FXD, ELCTLT:1UF, 20%, 35V (OPTION 01 ONLY)	05397	T368A105M035AZ
A10C1203	290-0920-00	8032090		CAP, FXD, ELCTLT:33UF, +50-10%, 35V (OPTION 01 ONLY)	55680	ULB1V330TEAANA
A10C1210	290-0721-00	8010100	8031979	CAP, FXD, ELCTLT:100UF, 20%, 20V (STANDARD ONLY)	56289	196D107X0020TE3

Component No.	Tektronix Part No.	Serial/Assembly No. Effective	Dscont	Name & Description	Mfr. Code	Mfr. Part No.
A10C1210	290-0770-00	8031980		CAP, FXD, ELCTLT:100UF, +50-10%, 25VOC (STANDARD ONLY)	54473	ECE-A25V100L
A10C1210	290-0721-00	8010100	8032089	CAP, FXD, ELCTLT:100UF, 20%, 20V (OPTION 01 ONLY)	56289	196D107X0020TE3
A10C1210	290-0770-00	8032089		CAP, FXD, ELCTLT:100UF, +50-10%, 25VOC (OPTION 01 ONLY)	54473	ECE-A25V100L
A10C1211	290-0831-00			CAP, FXD, ELCTLT:470UF, +50-10%, 50V	54473	ECE-A1HV471S
A10C1212	290-0831-00			CAP, FXD, ELCTLT:470UF, +50-10%, 50V	54473	ECE-A1HV471S
A10C1300	295-0191-00			CAP SET, MATCHED:2 EACH 1.0UF/0.1UF/0.01UF/9 95PF, 1.5%	80009	295-0191-00
A10C1301	295-0191-00			CAP SET, MATCHED:2 EACH 1.0UF/0.1UF/0.01UF/9 95PF, 1.5%	80009	295-0191-00
A10C1310	-----			(PART OF A10C1300)		
A10C1311	-----			(PART OF A10C1300)		
A10C1312	-----			(PART OF A10C1301)		
A10C1316	283-0766-00			CAP, FXD, MICA DI:47 PF, 1%, 500V	00853	D155E47000
A10C1320	-----			(PART OF A10C1301)		
A10C1321	-----			(PART OF A10C1300)		
A10C1322	-----			(PART OF A10C1301)		
A10C1400	283-0603-00			CAP, FXD, MICA DI:113PF, 2%, 300V	00853	D155F1130G0
A10C1401	283-0603-00			CAP, FXD, MICA DI:113PF, 2%, 300V	00853	D155F1130G0
A10C1402	281-0763-00			CAP, FXD, CER DI:47PF, 10%, 100V	04222	MA101A470KAA
A10C1403	281-0775-00			CAP, FXD, CER DI:0.1UF, 20%, 50V	04222	MA205E104MAA
A10C1405	281-0763-00			CAP, FXD, CER DI:47PF, 10%, 100V	04222	MA101A470KAA
A10C1406	281-0763-00	8030000		CAP, FXD, CER DI:47PF, 10%, 100V	04222	MA101A470KAA
A10C1407	281-0775-00			CAP, FXD, CER DI:0.1UF, 20%, 50V	04222	MA205E104MAA
A10C1420	290-0671-00	8010100	8031979	CAP, FXD, ELCTLT:150UF, 20%, 15V (STANDARD ONLY)	05397	T3680157M015AS
A10C1420	290-0987-00	8031980		CAP, FXD, ELCTLT:150UF, 20%, 16V (STANDARD ONLY)	55680	ULB1C151MEA
A10C1420	290-0671-00	8010100	8032089	CAP, FXD, ELCTLT:150UF, 20%, 15V (OPTION 01 ONLY)	05397	T3680157M015AS
A10C1420	290-0987-00	8032090		CAP, FXD, ELCTLT:150UF, 20%, 16V (OPTION 01 ONLY)	55680	ULB1C151MEA
A10C1421	290-0527-00	8010100	8031979	CAP, FXD, ELCTLT:15UF, 20%, 20V (STANDARD ONLY)	05397	T3688156M020AS
A10C1421	290-0745-00	8031980		CAP, FXD, ELCTLT:22UF, +50-10%, 25V (STANDARD ONLY)	54473	ECE-A25V22L
A10C1421	290-0527-00	8010100	8032089	CAP, FXD, ELCTLT:15UF, 20%, 20V (OPTION 01 ONLY)	05397	T3688156M020AS
A10C1421	290-0745-00	8032090		CAP, FXD, ELCTLT:22UF, +50-10%, 25V (OPTION 01 ONLY)	54473	ECE-A25V22L
A10C1500	283-0597-00			CAP, FXD, MICA DI:470PF, 10%, 300V	00853	D155F471K0
A10C1501	283-0597-00			CAP, FXD, MICA DI:470PF, 10%, 300V	00853	D155F471K0
A10C1502	290-0574-00	8010100	8031979	CAP, FXD, ELCTLT:47UF, 10%, 20V (STANDARD ONLY)	05397	T368C476K0202AS
A10C1502	290-0746-00	8031980		CAP, FXD, ELCTLT:47UF, +50-10%, 16V (STANDARD ONLY)	54473	ECE-A6V47L
A10C1502	290-0574-00	8010100	8032089	CAP, FXD, ELCTLT:47UF, 10%, 20V (OPTION 01 ONLY)	05397	T368C476K0202AS
A10C1502	290-0746-00	8032090		CAP, FXD, ELCTLT:47UF, +50-10%, 16V (OPTION 01 ONLY)	54473	ECE-A6V47L
A10C1503	281-0775-00			CAP, FXD, CER DI:0.1UF, 20%, 50V	04222	MA205E104MAA
A10C1504	281-0775-00			CAP, FXD, CER DI:0.1UF, 20%, 50V	04222	MA205E104MAA
A10C1505	290-0523-00			CAP, FXD, ELCTLT:2.2UF, 20%, 20V	05397	T368A225M020AS
A10C1510	290-0574-00	8010100	8031979	CAP, FXD, ELCTLT:47UF, 10%, 20V (STANDARD ONLY)	05397	T368C476K0202AS
A10C1510	290-0746-00	8031980		CAP, FXD, ELCTLT:47UF, +50-10%, 16V (STANDARD ONLY)	54473	ECE-A6V47L
A10C1510	290-0574-00	8010100	8032089	CAP, FXD, ELCTLT:47UF, 10%, 20V (OPTION 01 ONLY)	05397	T368C476K0202AS
A10C1510	290-0746-00	8032090		CAP, FXD, ELCTLT:47UF, +50-10%, 16V	54473	ECE-A6V47L

Component No.	Tektronix Part No.	Serial/Assembly No. Effective	Dscont	Name & Description	Mfr. Code	Mfr. Part No.
A10C1511	290-0574-00	8010100	8031979	(OPTION 01 ONLY) CAP, FXD, ELCTLT:47UF, 10%, 20V	05397	T368C476K0202AS
A10C1511	290-0746-00	8031980		(STANDARD ONLY) CAP, FXD, ELCTLT:47UF, +50-10%, 16V	54473	ECE-A6V47L
A10C1511	290-0574-00	8010100	8032089	(STANDARD ONLY) CAP, FXD, ELCTLT:47UF, 10%, 20V	05397	T368C476K0202AS
A10C1511	290-0746-00	8032090		(OPTION 01 ONLY) CAP, FXD, ELCTLT:47UF, +50-10%, 16V	54473	ECE-A6V47L
A10C1512	281-0811-00			CAP, FXD, CER DI:10PF, 10%, 100V	04222	MA101A100KAA
A10C1513	281-0775-00			CAP, FXD, CER DI:0.1UF, 20%, 50V	04222	MA205E104MAA
A10C1514	281-0763-00	8030000		CAP, FXD, CER DI:47PF, 10%, 100V	04222	MA101A470KAA
A10C1520	281-0767-00			CAP, FXD, CER DI:330PF, 20%, 100V	04222	MA106C331MAA
A10C1521	281-0775-00			CAP, FXD, CER DI:0.1UF, 20%, 50V	04222	MA205E104MAA
A10C1522	290-0534-00	8010100	8031979	CAP, FXD, ELCTLT:1UF, 20%, 35V	05397	T368A105M035AZ
A10C1522	290-0920-00	8031980		(STANDARD ONLY) CAP, FXD, ELCTLT:33UF, +50-10%, 35V	55680	ULB1V330TEAANA
A10C1522	290-0534-00	8010100	8032089	(STANDARD ONLY) CAP, FXD, ELCTLT:1UF, 20%, 35V	05397	T368A105M035AZ
A10C1522	290-0920-00	8032090		(OPTION 01 ONLY) CAP, FXD, ELCTLT:33UF, +50-10%, 35V	55680	ULB1V330TEAANA
A10C1523	290-0671-00	8010100	8031979	(OPTION 01 ONLY) CAP, FXD, ELCTLT:150UF, 20%, 15V	05397	T368D157M015AS
A10C1523	290-0987-00	8031980		(STANDARD ONLY) CAP, FXD, ELCTLT:150UF, 20%, 16V	55680	ULB1C151MEA
A10C1523	290-0671-00	8010100	8032089	(STANDARD ONLY) CAP, FXD, ELCTLT:150UF, 20%, 15V	05397	T368D157M015AS
A10C1523	290-0987-00	8032090		(OPTION 01 ONLY) CAP, FXD, ELCTLT:150UF, 20%, 16V	55680	ULB1C151MEA
A10C1524	281-0811-00			(OPTION 01 ONLY) CAP, FXD, CER DI:10PF, 10%, 100V	04222	MA101A100KAA
A10C1600	290-0718-00	8010100	8031979	CAP, FXD, ELCTLT:22UF, 20%, 35V	56289	1960226X0035PE4
A10C1600	290-0745-00	8031980		(STANDARD ONLY) CAP, FXD, ELCTLT:22UF, +50-10%, 25V	54473	ECE-A25V22L
A10C1600	290-0718-00	8010100	8032089	(STANDARD ONLY) CAP, FXD, ELCTLT:22UF, 20%, 35V	56289	1960226X0035PE4
A10C1600	290-0745-00	8032090		(OPTION 01 ONLY) CAP, FXD, ELCTLT:22UF, +50-10%, 25V	54473	ECE-A25V22L
A10C1601	290-0517-00			(OPTION 01 ONLY) CAP, FXD, ELCTLT:6.8UF, 20%, 35V	05397	T3688685M035AZ
A10C1602	283-0212-00			CAP, FXD, CER DI:2UF, 20%, 50V	04222	SR405E205MAA
A10C1603	283-0059-00			CAP, FXD, CER DI:1UF, +80-20%, 50V	31433	C330C105M5R5CA
A10C1610	281-0775-00			CAP, FXD, CER DI:0.1UF, 20%, 50V	04222	MA205E104MAA
A10C1611	290-0523-00			CAP, FXD, ELCTLT:2.2UF, 20%, 20V	05397	T368A225M020AS
A10C1620	281-0775-00			CAP, FXD, CER DI:0.1UF, 20%, 50V	04222	MA205E104MAA
A10C1621	281-0759-00			CAP, FXD, CER DI:22PF, 10%, 100V	04222	MA101A220KAA
A10C1622	281-0763-00	8030000		CAP, FXD, CER DI:47PF, 10%, 100V	04222	MA101A470KAA
A10C1720	281-0773-00			CAP, FXD, CER DI:0.01UF, 10%, 100V	04222	MA201C103KAA
A10CR1100	152-0141-02			SEMICOND DVC, DI:SM, SI, 30V, 150MA, 30V	03508	DA2527 (1N4152)
A10CR1110	152-0141-02			SEMICOND DVC, DI:SM, SI, 30V, 150MA, 30V	03508	DA2527 (1N4152)
A10CR1111	152-0141-02			SEMICOND DVC, DI:SM, SI, 30V, 150MA, 30V	03508	DA2527 (1N4152)
A10CR1112	152-0141-02			SEMICOND DVC, DI:SM, SI, 30V, 150MA, 30V	03508	DA2527 (1N4152)
A10CR1113	152-0585-00			SEMICOND DVC, DI:RECT, SI, 200V, 1A	14936	MO2M-30
A10CR1114	152-0585-00			SEMICOND DVC, DI:RECT, SI, 200V, 1A	14936	MO2M-30
A10CR1200	152-0141-02			SEMICOND DVC, DI:SM, SI, 30V, 150MA, 30V	03508	DA2527 (1N4152)
A10CR1201	152-0141-02	8052440		SEMICOND DVC, DI:SM, SI, 30V, 150MA, 30V	03508	DA2527 (1N4152)
A10CR1201	152-0141-02	8052430		(STANDARD ONLY) SEMICOND DVC, DI:SM, SI, 30V, 150MA, 30V	03508	DA2527 (1N4152)
A10CR1412	152-0141-02			(OPTION 01 ONLY) SEMICOND DVC, DI:SM, SI, 30V, 150MA, 30V	03508	DA2527 (1N4152)
A10CR1413	152-0141-02			SEMICOND DVC, DI:SM, SI, 30V, 150MA, 30V	03508	DA2527 (1N4152)
A10CR1500	152-0141-02	8052440		SEMICOND DVC, DI:SM, SI, 30V, 150MA, 30V	03508	DA2527 (1N4152)

Component No.	Tektronix Part No.	Serial/Assembly No. Effective	Dscont	Name & Description	Mfr. Code	Mfr. Part No.
A10CR1500	152-0141-02	8052430		(STANDARD ONLY) SEMICON DVC,DI:SM,SI,30V,150MA,30V (OPTION 01 ONLY)	03508	0A2527 (1N4152)
A10CR1501	152-0141-02			SEMICON DVC,DI:SM,SI,30V,150MA,30V	03508	0A2527 (1N4152)
A10CR1502	152-0141-02			SEMICON DVC,DI:SM,SI,30V,150MA,30V	03508	0A2527 (1N4152)
A10CR1510	152-0141-02			SEMICON DVC,DI:SM,SI,30V,150MA,30V	03508	0A2527 (1N4152)
A10OS1424	150-0077-01			LAMP, INCAND:14V,0.08A,#22820,WIRE LEADS	08806	21620
A10F1220	159-0025-00			FUSE,CARTRIDGE:3AG,0.5A,250V,0.25SEC	71400	AGC-CM-1/2
A10J1300	131-1857-00			TERM SET,PIN:36/0.025 SQ PIN,ON 0.1 CTRS (OPTION 01 ONLY)	TK1483	082-3643-SS10
A10J1500	131-1857-00			TERM SET,PIN:36/0.025 SQ PIN,ON 0.1 CTRS	TK1483	082-3643-SS10
A10J1510	131-1857-00			TERM SET,PIN:36/0.025 SQ PIN,ON 0.1 CTRS	TK1483	082-3643-SS10
A10J1520	131-1857-00			TERM SET,PIN:36/0.025 SQ PIN,ON 0.1 CTRS (OPTION 01 ONLY)	TK1483	082-3643-SS10
A10Q1110	151-1025-00			TRANSISTOR:FET,N-CHAN,SI,TO-92	04713	SPF3036
A10Q1300	151-0301-00			TRANSISTOR:PMP,SI,TO-18	04713	ST898
A10Q1301	151-0302-00			TRANSISTOR:NPN,SI,TO-18	04713	ST899
A10Q1410	151-0301-00			TRANSISTOR:PMP,SI,TO-18	04713	ST898
A10Q1411	151-0302-00			TRANSISTOR:NPN,SI,TO-18	04713	ST899
A10Q1501	151-1021-00			TRANSISTOR:FET,N-CHAN,SI,TO-18	80009	151-1021-00
A10Q1600	151-0301-00			TRANSISTOR:PMP,SI,TO-18	04713	ST898
A10Q1610	151-0302-00			TRANSISTOR:NPN,SI,TO-18	04713	ST899
A10Q1611	151-0301-00			TRANSISTOR:PMP,SI,TO-18	04713	ST898
A10Q1620	151-1025-00			TRANSISTOR:FET,N-CHAN,SI,TO-92	04713	SPF3036
A10R1100	315-0301-00			RES,FXD,FILM:300 OHM,5%,0.25W	57668	NTR25J-E300E
A10R1101	321-0356-00			RES,FXD,FILM:49.9K OHM,1%,0.125W,TC=TO	19701	5033ED49K90F
A10R1102	321-0356-00			RES,FXD,FILM:49.9K OHM,1%,0.125W,TC=TO	19701	5033ED49K90F
A10R1103	315-0751-00	8010100	8052439	RES,FXD,FILM:750 OHM,5%,0.25W (STANDARD ONLY)	57668	NTR25J-E750E
A10R1103	315-0821-00	8052440		RES,FXD,FILM:820 OHM,5%,0.25W (STANDARD ONLY)	19701	5043CX820R0J
A10R1103	315-0751-00	8010100	8052429	RES,FXD,FILM:750 OHM,5%,0.25W (OPTION 01 ONLY)	57668	NTR25J-E750E
A10R1103	315-0821-00	8052430		RES,FXD,FILM:820 OHM,5%,0.25W (OPTION 01 ONLY)	19701	5043CX820R0J
A10R1104	315-0301-00			RES,FXD,FILM:300 OHM,5%,0.25W	57668	NTR25J-E300E
A10R1110	315-0751-00			RES,FXD,FILM:750 OHM,5%,0.25W	57668	NTR25J-E750E
A10R1111	315-0751-00			RES,FXD,FILM:750 OHM,5%,0.25W	57668	NTR25J-E750E
A10R1120	307-0103-00			RES,FXD,CMPNSN:2.7 OHM,5%,0.25W	01121	CB2705
A10R1121	307-0103-00			RES,FXD,CMPNSN:2.7 OHM,5%,0.25W	01121	CB2705
A10R1200	303-0202-00			RES,FXD,CMPNSN:2K OHM,5%,1M	01121	GB 2025
A10R1201	315-0471-00			RES,FXD,FILM:470 OHM,5%,0.25W	57668	NTR25J-E470E
A10R1202	315-0470-00			RES,FXD,FILM:47 OHM,5%,0.25W	57668	NTR25J-E470E
A10R1203	315-0103-00			RES,FXD,FILM:10K OHM,5%,0.25W	19701	5043CX10K00J
A10R1204	315-0102-00			RES,FXD,FILM:1K OHM,5%,0.25W	57668	NTR25J-E10K0
A10R1205	321-0336-00	8010100	8052439	RES,FXD,FILM:30.9K OHM,1%,0.125W,TC=TO (STANDARD ONLY)	19701	5043ED30K90F
A10R1205	321-0322-00	8052440		RES,FXD,FILM:22.1K OHM,0.1%,0.125W,TC=TO (STANDARD ONLY)	19701	5033ED22K10F
A10R1205	321-0336-00	8010100	8052429	RES,FXD,FILM:30.9K OHM,1%,0.125W,TC=TO (OPTION 01 ONLY)	19701	5043ED30K90F
A10R1205	321-0322-00	8052430		RES,FXD,FILM:22.1K OHM,0.1%,0.125W,TC=TO (OPTION 01 ONLY)	19701	5033ED22K10F
A10R1206	321-0333-00			RES,FXD,FILM:28.7K OHM,1%,0.125W,TC=TO	19701	5043ED28K70F
A10R1207	315-0560-00			RES,FXD,FILM:56 OHM,5%,0.25W	57668	NTR25J-E560E
A10R1208	315-0100-00			RES,FXD,FILM:10 OHM,5%,0.25W	19701	5043CX10R00J
A10R1300	301-0821-00			RES,FXD,FILM:820 OHM,5%,0.5W	19701	5053CX820R0J
A10R1301	311-1560-00			RES,VAR,NONNM:TRMR,5K OHM,0.5W	32997	3352T-1-502
A10R1400	321-0222-07			RES,FXD,FILM:2.0K OHM,0.1%,0.125W,TC=T9	19701	5033RE2K000B
A10R1401	321-0222-07			RES,FXD,FILM:2.0K OHM,0.1%,0.125W,TC=T9	19701	5033RE2K000B
A10R1405	315-0471-00	8030000		RES,FXD,FILM:470 OHM,5%,0.25W	57668	NTR25J-E470E

Component No.	Tektronix Part No.	Serial/Assembly No.		Name & Description	Mfr. Code	Mfr. Part No.
		Effective	Dscont			
A10R1410	321-0300-00			RES,FXD,FILM:13.0K OHM,1%,0.125M,TC=TO	07716	CEAD13001F
A10R1411	321-0236-00			RES,FXD,FILM:2.80K OHM,1%,0.125M,TC=TO	07716	CEAD28000F
A10R1412	321-0236-00			RES,FXD,FILM:2.80K OHM,1%,0.125M,TC=TO	07716	CEAD28000F
A10R1413	321-0300-00			RES,FXD,FILM:13.0K OHM,1%,0.125M,TC=TO	07716	CEAD13001F
A10R1414	315-0104-00			RES,FXD,FILM:100K OHM,5%,0.25M	57668	NTR25J-E100K
A10R1415	315-0104-00			RES,FXD,FILM:100K OHM,5%,0.25M	57668	NTR25J-E100K
A10R1420	315-0104-00			RES,FXD,FILM:100K OHM,5%,0.25M	57668	NTR25J-E100K
A10R1421	315-0514-00			RES,FXD,FILM:510K OHM,5%,0.25M	19701	5043CX510K0J
A10R1422	315-0104-00			RES,FXD,FILM:100K OHM,5%,0.25M	57668	NTR25J-E100K
A10R1423	311-1562-00			RES,VAR,NONMM:TRMR,2K OHM,0.5M	32997	3352T-DY7-202
A10R1500	321-0204-00			RES,FXD,FILM:1.30K OHM,1%,0.125M,TC=TO	19701	5033ED1K300F
A10R1501	321-0204-00			RES,FXD,FILM:1.30K OHM,1%,0.125M,TC=TO	19701	5033ED1K300F
A10R1502	321-0279-00			RES,FXD,FILM:7.87K OHM,1%,0.125M,TC=TO	07716	CEAD78700F
A10R1503	321-0421-00	8010100	8052439	RES,FXD,FILM:237K OHM,1%,0.125M,TC=TO (STANDARD ONLY)	07716	CEAD23702F
A10R1503	321-0407-00	8052440		RES,FXD,FILM:169K OHM,1%,0.125M,TC=TO (STANDARD ONLY)	07716	CEAD16902F
A10R1503	321-0421-00	8010100	8052429	RES,FXD,FILM:237K OHM,1%,0.125M,TC=TO (OPTION 01 ONLY)	07716	CEAD23702F
A10R1503	321-0407-00	8052430		RES,FXD,FILM:169K OHM,1%,0.125M,TC=TO (OPTION 01 ONLY)	07716	CEAD16902F
A10R1504	321-0289-00			RES,FXD,FILM:10.0K OHM,1%,0.125M,TC=TO	19701	5033ED10K0F
A10R1505	315-0105-00			RES,FXD,FILM:1M OHM,5%,0.25M	19701	5043CX1M000J
A10R1506	315-0105-00			RES,FXD,FILM:1M OHM,5%,0.25M	19701	5043CX1M000J
A10R1507	315-0104-00	8030000		RES,FXD,FILM:100K OHM,5%,0.25M	57668	NTR25J-E100K
A10R1508	315-0104-00	8052439		RES,FXD,FILM:100K OHM,5%,0.25M (STANDARD ONLY)	57668	NTR25J-E100K
A10R1508	315-0104-00	8052430		RES,FXD,FILM:100K OHM,5%,0.25M (OPTION 01 ONLY)	57668	NTR25J-E100K
A10R1510	321-0289-07			RES,FXD,FILM:10.0K OHM,0.1%,0.125M,TC=T9	19701	5033RE10K008
A10R1511	321-0481-00			RES,FXD,FILM:1M OHM,1%,0.125M,TC=TO	19701	5043ED1M000F
A10R1512	321-0481-00			RES,FXD,FILM:1M OHM,1%,0.125M,TC=TO	19701	5043ED1M000F
A10R1513	321-0289-07			RES,FXD,FILM:10.0K OHM,0.1%,0.125M,TC=T9	19701	5033RE10K008
A10R1514	321-0214-00			RES,FXD,FILM:1.65K OHM,1%,0.125M,TC=TO	19701	5033ED1K65F
A10R1515	321-0353-00	8010100	8052740	RES,FXD,FILM:46.4K OHM,1%,0.125M,TC=TO	07716	CEAD46401F
A10R1515	321-0360-00	8052741		RES,FXD,FILM:54.9K OHM,1%,0.125M,TC=TO	19701	5033ED54K90F
A10R1516	315-0473-00			RES,FXD,FILM:47K OHM,5%,0.25M	57668	NTR25J-E47K0
A10R1517	321-0225-06			RES,FXD,FILM:2.15K OHM,0.25%,0.125M,T=T9M1	07716	CEAE21500C
A10R1518	311-1403-00			RES,VAR,NONMM:PNL,5K OHM,1M,1/SM	01121	18M651
A10R1519	315-0104-00			RES,FXD,FILM:100K OHM,5%,0.25M	57668	NTR25J-E100K
A10R1520	321-0164-00			RES,FXD,FILM:499 OHM,1%,0.125M,TC=TO (STANDARD ONLY)	19701	5033ED499R0F
A10R1521	321-0230-00			RES,FXD,FILM:2.43K OHM,1%,0.125M,TC=TO	19701	5043ED2K430F
A10R1522	321-0276-00			RES,FXD,FILM:7.32K OHM,1%,0.125M,TC=TO	19701	5043ED7K320F
A10R1523	315-0512-00			RES,FXD,FILM:5.1K OHM,5%,0.25M	57668	NTR25J-E05K1
A10R1524	315-0103-00			RES,FXD,FILM:10K OHM,5%,0.25M	19701	5043CX10K00J
A10R1525	321-0256-00			RES,FXD,FILM:4.53K OHM,1%,0.125M,TC=T9	19701	5033ED4K530F
A10R1526	315-0331-00	8030000		RES,FXD,FILM:330 OHM,5%,0.25M	57668	NTR25J-E330E
A10R1600	315-0683-00			RES,FXD,FILM:68K OHM,5%,0.25M	57668	NTR25J-E68K0
A10R1601	315-0752-00			RES,FXD,FILM:7.5K OHM,5%,0.25M	57668	NTR25J-E07K5
A10R1609	315-0123-00			RES,FXD,FILM:12K OHM,5%,0.25M	57668	NTR25J-E12K0
A10R1610	315-0182-00			RES,FXD,FILM:1.8K OHM,5%,0.25M	57668	NTR25J-E1K8
A10R1611	315-0102-00			RES,FXD,FILM:1K OHM,5%,0.25M	57668	NTR25JE01K0
A10R1612	321-1263-02			RES,FXD,FILM:5.42K OHM,0.5%,0.125M,TC=T2	19701	5033RC5K4200
A10R1613	321-0361-00			RES,FXD,FILM:56.2K OHM,1%,0.125M,TC=TO	07716	CEAD56201F
A10R1620	315-0511-00			RES,FXD,FILM:510 OHM,5%,0.25M	19701	5043CX510R0J
A10R1621	315-0680-00			RES,FXD,FILM:68 OHM,5%,0.25M	57668	NTR25J-E68E0
A10R1701	315-0102-00			RES,FXD,FILM:1K OHM,5%,0.25M	57668	NTR25JE01K0
A10R1711	321-0680-03			RES,FXD,FILM:35.3K OHM,0.25%,0.125M,TC=T2	19701	5033RC35K300

Component No.	Tektronix Part No.	Serial/Assembly No. Effective	Dscont	Name & Description	Mfr. Code	Mfr. Part No.
A10R1712	321-0680-03			RES,FXD,FILM:35.3K OHM,0.25%,0.125M,TC=T2	19701	5033RC35K300
A10R1720	307-0669-00			RES NTMK,FXD,FI:STEP ATTENUATOR	80009	307-0669-00
A10R1721	315-0100-00			RES,FXD,FILM:10 OHM,5%,0.25M	19701	5043CX10RR00J
A10S1410	260-1985-00			SWITCH,PUSH:6 BTN,0/2/4 POLE,FREQ RANGE	59821	A2KBM1230001266
A10S1710	263-1182-00			SM CAM ACTR AS:ATTENUATOR	80009	263-1182-00
A10T1220	120-1284-00			XFMR,PMR,STPON:LOW FREQUENCY	80009	120-1284-00
A10TP1510	214-0579-00			TERM,TEST POINT:8RS CD PL	80009	214-0579-00
A10U1101	156-0158-00			MICROCKT,LINEAR:DUAL OPNL AMPL	04713	MC1458P1/MC1458U
A10U1300	156-0109-00			CPLR,OPTOELECTR:LED & PHOTOTRANSISTOR	09019	H11AX881
A10U1400	156-1338-00			MICROCKT,LINEAR:OPERATIONAL AMPLIFIER	01295	NE5534P
A10U1401	156-1338-00			MICROCKT,LINEAR:OPERATIONAL AMPLIFIER	01295	NE5534P
A10U1500	156-1149-00			MICROCKT,LINEAR:OPERATIONAL AMP,JFET INPUT	27014	LF351N/GLEA134
A10U1510	156-1338-00			MICROCKT,LINEAR:OPERATIONAL AMPLIFIER	01295	NE5534P
A10U1520	156-1338-00			MICROCKT,LINEAR:OPERATIONAL AMPLIFIER	01295	NE5534P
A10U1700	156-1149-00			MICROCKT,LINEAR:OPERATIONAL AMP,JFET INPUT	27014	LF351N/GLEA134
A10VR1201	152-0437-00	8010100	8052439	SEMICOND OVC,DI:ZEN,SI,8.2V,ZZ,0.4M,00-7 (STANDARD ONLY)	04713	SZG14RL
A10VR1201	152-0760-00	8052440		SEMICOND OVC,DI:ZEN,SI,6.2V,ZZ,400MM,00-35 (STANDARD ONLY)	04713	SZG30205
A10VR1201	152-0437-00	8010100	8052429	SEMICOND OVC,DI:ZEN,SI,8.2V,ZZ,0.4M,00-7 (OPTION 01 ONLY)	04713	SZG14RL
A10VR1201	152-0760-00	8052430		SEMICOND OVC,DI:ZEN,SI,6.2V,ZZ,400MM,00-35 (OPTION 01 ONLY)	04713	SZG30205
A10VR1600	152-0395-00			SEMICOND OVC,DI:ZEN,SI,4.3V,5%,0.4M	04713	SZG35009K18
A10W1300	131-0566-00			BUS,COND:DUMMY RES,0.094 OD X 0.225L (STANDARD ONLY)	24546	0MA 07
A11	670-6339-00			CIRCUIT 80 ASSY:IMD (OPTION 01 ONLY)	80009	670-6339-00
A11C1100	285-1050-00			CAP,FXD,PLASTIC:0.1UF,1%,200V	14752	23081C104F
A11C1101	281-0773-00			CAP,FXD,CER DI:0.01UF,10%,100V	04222	MA201C103KAA
A11C1110	281-0775-00			CAP,FXD,CER DI:0.1UF,20%,50V	04222	MA205E104MAA
A11C1111	281-0775-00			CAP,FXD,CER DI:0.1UF,20%,50V	04222	MA205E104MAA
A11C1112	290-0846-00			CAP,FXD,ELCTLT:47UF,+75-10%,35V	54473	ECE-A35V47LU
A11C1113	290-0846-00			CAP,FXD,ELCTLT:47UF,+75-10%,35V	54473	ECE-A35V47LU
A11C1200	285-1050-00			CAP,FXD,PLASTIC:0.1UF,1%,200V	14752	23081C104F
A11CR1110	152-0141-02			SEMICOND OVC,DI:SM,SI,30V,150MA,30V	03508	0A2527 (1N4152)
A11J1100	131-0608-00			TERMINAL,PIN:0.365 L X 0.025 BRZ GLD PL (QUANTITY 4)	22526	48283-036
A11J1101	131-0608-00			TERMINAL,PIN:0.365 L X 0.025 BRZ GLD PL (QUANTITY 2)	22526	48283-036
A11J1102	131-0608-00			TERMINAL,PIN:0.365 L X 0.025 BRZ GLD PL (QUANTITY OF 2)	22526	48283-036
A11J1110	131-0608-00			TERMINAL,PIN:0.365 L X 0.025 BRZ GLD PL (QUANTITY 5)	22526	48283-036
A11Q1110	151-0188-00			TRANSISTOR:PMP,SI,TO-92	80009	151-0188-00
A11Q1111	151-1025-00			TRANSISTOR:FET,N-CHAN,SI,TO-92	04713	SPF3036
A11R1100	321-0748-06			RES,FXD,FILM:4.95K OHM,0.25%,0.125M,TC=T9	19701	5033RE4K950C
A11R1101	321-1619-07			RES,FXD,FILM:8.334K OHM,0.1%,0.125M,TC=T9	19701	5033RE8K3348
A11R1102	321-1329-03			RES,FXD,FILM:26.4K OHM,0.25%,0.125M,TC=T2	19701	5033RC26K40C
A11R1103	321-1329-03	8010100	8052439	RES,FXD,FILM:26.4K OHM,0.25%,0.125M,TC=T2 (STANDARD ONLY)	19701	5033RC26K40C
A11R1104	321-1619-07			RES,FXD,FILM:8.334K OHM,0.1%,0.125M,TC=T9	19701	5033RE8K3348
A11R1106	315-0103-00			RES,FXD,FILM:10K OHM,5%,0.25M	19701	5043CX10K00J
A11R1107	315-0103-00			RES,FXD,FILM:10K OHM,5%,0.25M	19701	5043CX10K00J
A11R1110	321-0164-00			RES,FXD,FILM:499 OHM,1%,0.125M,TC=TO	19701	5033ED499R0F
A11R1111	321-0231-00			RES,FXD,FILM:2.49K OHM,1%,0.125M,TC=TO	19701	5033ED2K49F
A11R1112	321-0202-00			RES,FXD,FILM:1.24K OHM,1%,0.125M,TC=TO	24546	NA55D1241F
A11R1113	321-0202-00			RES,FXD,FILM:1.24K OHM,1%,0.125M,TC=TO	24546	NA55D1241F
A11R1115	315-0105-00			RES,FXD,FILM:1M OHM,5%,0.25M	19701	5043CX1M000J
A11R1116	315-0102-00			RES,FXD,FILM:1K OHM,5%,0.25M	57668	NTR25JED1K0

Component No.	Tektronix Part No.	Serial/Assembly No. Effective	Dscont	Name & Description	Mfr. Code	Mfr. Part No.
A11R1210	321-0639-00			RES,FXD,FILM:9.6K OHM,1%,0.125M,TC=TO	19701	5043ED9K600F
A11R1211	311-1564-00			RES,VAR,NONMM:TRMR,500 OHM,0.5M	32997	3352T-CK5501
A11R1212	321-0257-00			RES,FXD,FILM:4.64K OHM,1%,0.125M,TC=TO	19701	5043ED4K640F
A11R1213	321-0297-00			RES,FXD,FILM:12.1K OHM,1%,0.125M,TC=TO	07716	CEAD12101F
A11S1110	260-1486-00			SWITCH,PUSH:1 BUTTON,4 POLE,MAGNIFIER	80009	260-1486-00
A11U1100	156-0742-00			MICROCKT,LINEAR:OPNL AMPL	01295	LM318P
DS510	150-1029-00			LT EMITTING DIO:GREEN,565NM,35MA	58361	Q6480/MV5274C
J540	131-0274-00			CONN,RCPT,ELEC:BNC,FEMALE	24931	28JR209-1 IP-23
J550	131-0955-00			CONN,RCPT,ELEC:BNC,FEMALE	13511	31-279
P1101	175-2772-00			CA ASSY,SP,ELEC:2,26 AWG,5.0 L (OPT 01 ONLY-FROM A11J1101 TO A10J1300)	80009	175-2772-00
P1110	175-2774-00	8010100	8052749	CA ASSY,SP,ELEC:5,26 AWG,3.0 L	80009	175-2774-00
P1110	175-2774-01	8052750		CA ASSY,SP,ELEC:5,26 AWG,3.0 L,RIBBON (OPT 01 ONLY-FROM A11J1110 TO A10J1520)	80009	175-2774-01
P1500	175-2773-00			CA ASSY,SP,ELEC:6,26 AWG,4.0 L (FROM J1500 TO R520,R530)	80009	175-2773-00
P1510	175-2771-00			CA ASSY,SP,ELEC:3,26 AWG,5.0 L (FROM J1510 TO R510)	80009	175-2771-00
R510	311-1095-00			RES,VAR,NONMM:PNL,10K OHM,0.5M	01121	W-7708
R520	311-1502-00			RES,VAR,MM:PNL,2 X 10K OHM,2.75M	02111	100-9625
R530	-----			(PART OF R520)		



11/11/11

DIAGRAMS AND CIRCUIT BOARD ILLUSTRATIONS

Symbols

Graphic symbols and class designation letters are based on ANSI Standard Y32.2-1975.

Logic symbology is based on ANSI Y32.14-1973 in terms of positive logic. Logic symbols depict the logic function performed and may differ from the manufacturer's data.

The overline on a signal name indicates that the signal performs its intended function when it is in the low state.

Abbreviations are based on ANSI Y1.1-1972.

Other ANSI standards that are used in the preparation of diagrams by Tektronix, Inc. are:

- Y14.15, 1966 Drafting Practices.
- Y14.2, 1973 Line Conventions and Lettering.
- Y10.5, 1968 Letter Symbols for Quantities Used in Electrical Science and Electrical Engineering.

American National Standard Institute
1430 Broadway
New York, New York 10018

Component Values

Electrical components shown on the diagrams are in the following units unless noted otherwise:

- Capacitors = Values one or greater are in picofarads (pF).
Values less than one are in microfarads (μ F).
- Resistors = Ohms (Ω).

The following special symbols may appear on the diagrams:

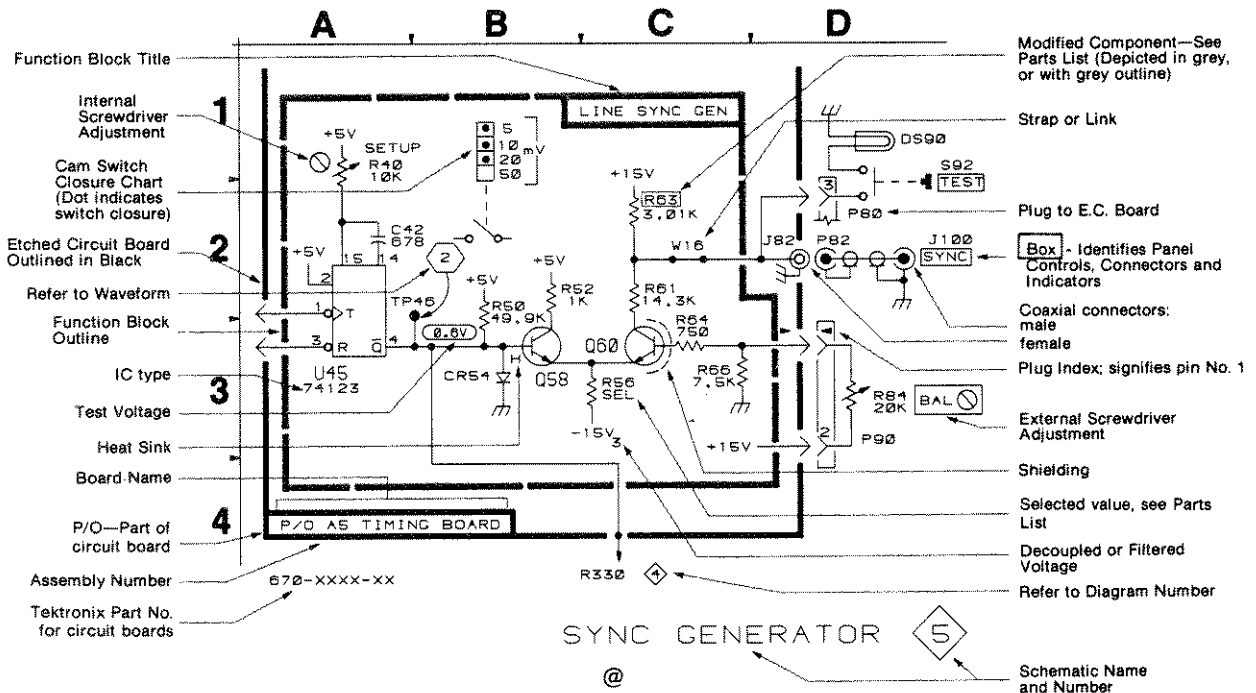

Assembly Numbers and Grid Coordinates

Each assembly in the instrument is assigned an assembly number (e.g., A20). The assembly number appears on the circuit board outline on the diagram, in the title for the circuit board component location illustration, and in the lookup table for the schematic diagram and corresponding component locator illustration. The Replaceable Electrical Parts list is arranged by assemblies in numerical sequence; the components are listed by component number (see following illustration for constructing a component number).

COMPONENT NUMBER EXAMPLE

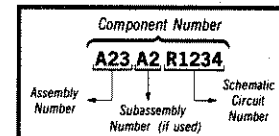

Chassis-mounted components have no Assembly Number prefix—see end of Replaceable Electrical Parts List.

The schematic diagram and circuit board component location illustration have grids. A lookup table with the grid coordinates is provided for ease of locating the component. Only the components illustrated on the facing diagram are listed in the lookup table. When more than one schematic diagram is used to illustrate the circuitry on a circuit board, the circuit board illustration may only appear opposite the first diagram on which it was illustrated; the lookup table will list the diagram number of other diagrams that the circuitry of the circuit board appears on.

TABLE 8-1

REAR INTERFACE CONNECTOR ASSIGNMENTS

Output or Input	Pin B		Pin A	Output or Input
Sync Common	28	SG Barrier Slot	28	
Sync Output	27		27	
	26		26	Buffered Main Output Common
	25		25	Buffered Main Output
	24		24	
	23	TM 500 Barrier Slot	23	
	22		22	
	21		21	
	20		20	
	19		19	
	18		18	
	17		17	
	16		16	
	15		15	
	14		14	
	13		13	
	12		12	
Collector lead of PNP Series-Pass	11		11	Base lead of PNP Series-Pass
	10		10	Emitter lead of PNP Series-Pass
-33.5 V Common	9		9	-33.5 V Common
	8	8	-33.5 V dc	
Collector Lead of NPN Series-Pass	7	7	Emitter lead of NPN Series-Pass	
	6	Rear View of Plug-in	6	Base lead of NPN Series-Pass
	5		5	
+11.5 V Common	4		4	+11.5 V Common
+11.5 V Common	3		3	+11.5 V Common
	2		2	+11.5 V filtered DC
25 V ac	1		1	25 V ac
	B		A	

SG 505 SIMPLIFIED BLOCK DIAGRAM

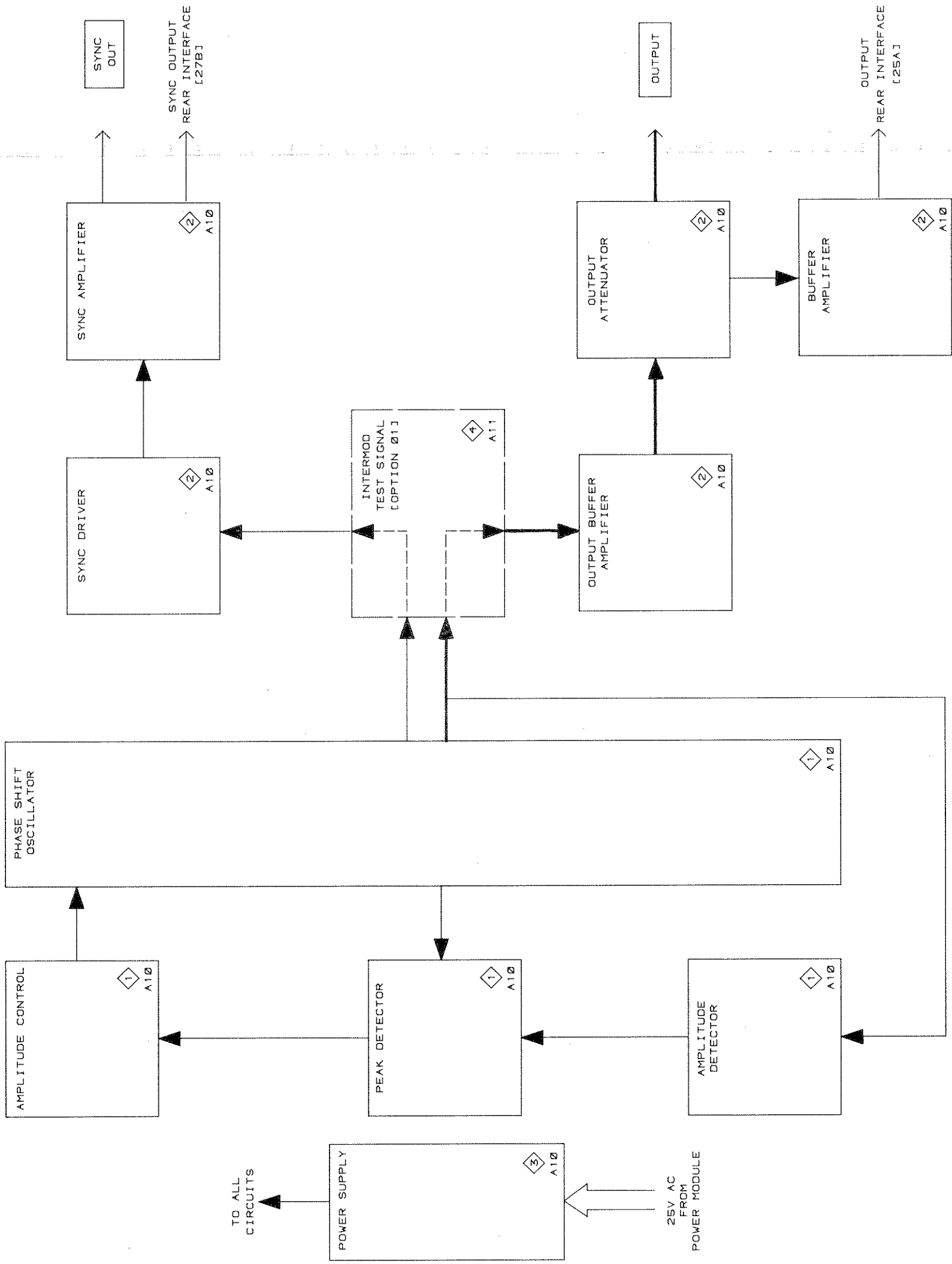

2823-25

@

Fig. 8-1. SG 505 Simplified block diagram.

PARTS LOCATION GRID

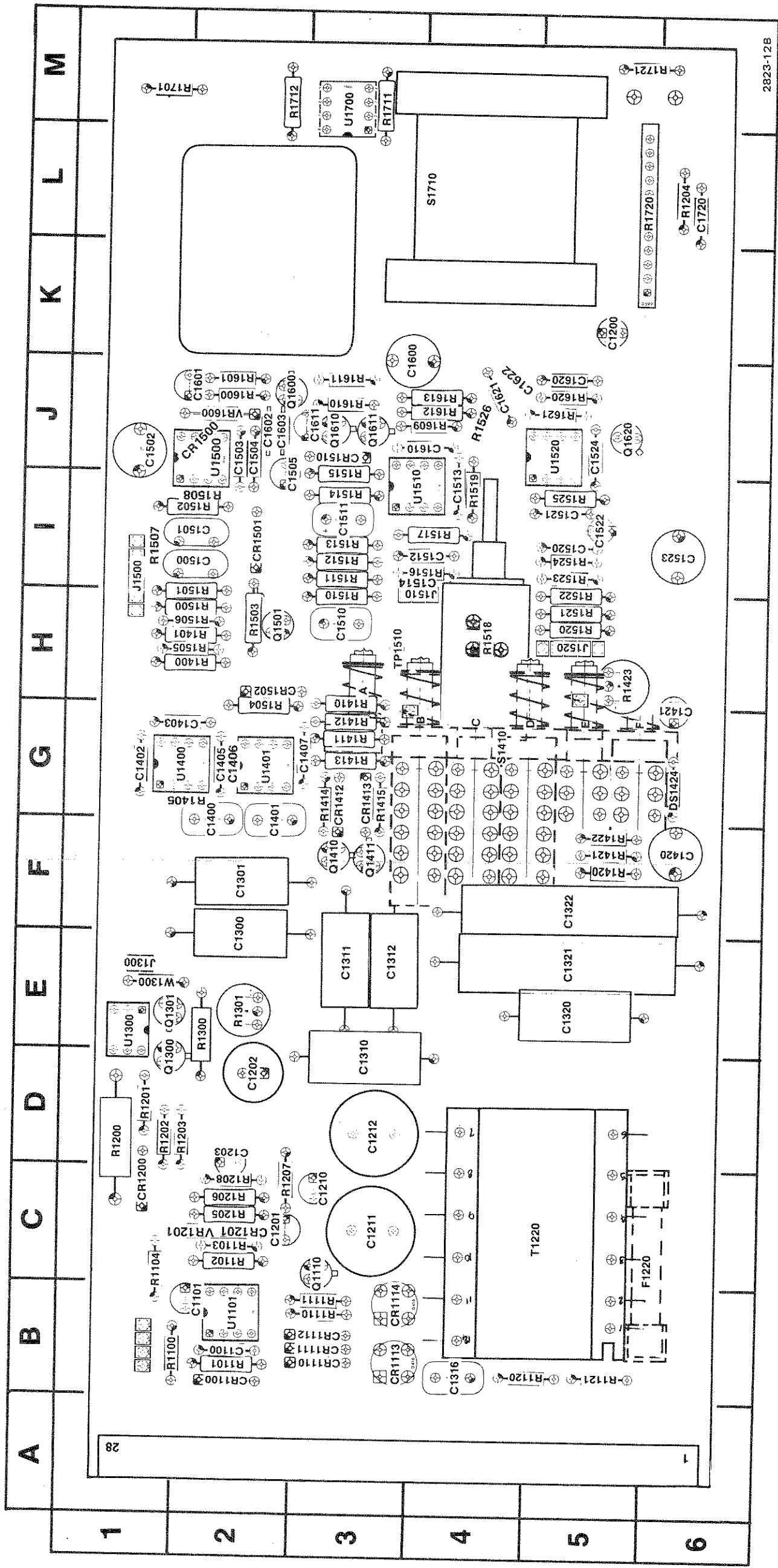
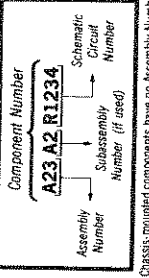

Fig. 8-2. Oscillator board (A10).

COMPONENT NUMBER EXAMPLE



 Static Sensitive Devices
See Maintenance Section

Table 8-2 COMPONENT REFERENCE CHART

P/O A10 ASSY			Oscillator 1		
Circuit Number	Schematic Location	Board Location	Circuit Number	Schematic Location	Board Location
C1300	L3	E2	R520	F3	CHASSIS
C1301	H2	F2	R530	J4	CHASSIS
C1310	L2	D3	R1400	K4	H2
C1311	L2	E3	R1401	F3	H2
C1312	J2	E3	R1405*†	L5	G2
C1320	J2	E5	R1410	K5	G3
C1321	L2	E5	R1411	K5	G3
C1322	J1	F5	R1412	J6	G3
C1400	H3	F2	R1413	J6	G3
C1401	L3	F2	R1414	K4	G3
C1402	H4	G1	R1415	K6	G3
C1403	H3	G2	R1420	F1	F5
C1405	L4	G2	R1421	K2	F5
C1406*†	L4	G2	R1422	K2	F5
C1407	L4	G3	R1500	J5	H2
C1420	A6	F6	R1501	F4	H2
C1421	C6	G6	R1502	A4	I2
C1500	J5	I2	R1503	H7	H2
C1501	E4	I2	R1504	J6	G2
C1502	A4	J1	R1505	J4	H2
C1503	F7	J2	R1506	F3	H2
C1504	F6	J2	R1507*†	A5	I1
C1505	H6	J2	R1508*†	H7	I2
C1510	D5	H3	R1510	D5	H3
C1511	D4	I3	R1511	D4	I3
C1512	D2	I4	R1512	D5	I3
C1513	D3	I4	R1513	D4	I3
C1514*†	E2	I4	R1514	C3	I3
C1523	B6	I6	R1515*	C3	I3
C1600	D7	J3	R1516	C3	I4
C1601	F5	J2	R1517	D2	I4
C1602	D7	J2	R1519	D4	I4
C1603	E5	J2	R1523	H5	I5
C1610	D3	J4	R1600	E7	J2
C1611	D6	J3	R1601	F6	J2
CR1412	K4	G3	R1609	E3	J4
CR1413	K6	G3	R1610	D7	J3
CR1500*†	F7	J2	R1611	D7	J3
CR1501	H6	I2	R1612	D2	J4
CR1502	H6	H2	R1613	D6	J4
CR1510	D6	J3	S1410B	C6	G4
J1500	J4	I1	S1410B	H2	G4
J1500	F3	I1	S1410C	B6	G4
J1510	B3	H4	S1410C	L2	G4
P1500	J4	CHASSIS	S1410C	H2	G4
P1500	F3	CHASSIS	S1410D	A5	G4
P1510	B3	CHASSIS	S1410D	H1	G4
Q1410	K5	F3	S1410D	H5	G4
Q1411	K6	F3	S1410D	K2	G4
Q1501	C4	H2	TP1510	A7	H3
Q1600	E7	J2	U1400	H3	G2
Q1610	D7	J3	U1401	L4	G2
Q1611	D6	J3	U1500	H6	J2
R510	B3	CHASSIS	U1510	D3	I3
			VR1600	F7	J2

PO/ A10 ASSY also shown on 2 3

*SEE PARTS LIST FOR SERIAL NUMBER RANGES.

†LOCATED ON BACK OF BOARD

1
2
3
4
5
6
7
8
9
10
11
12
13
14
15
16
17
18
19
20
21
22
23
24
25
26
27
28
29
30
31
32
33
34
35
36
37
38
39
40
41
42
43
44
45
46
47
48
49
50
51
52
53
54
55
56
57
58
59
60
61
62
63
64
65
66
67
68
69
70
71
72
73
74
75
76
77
78
79
80
81
82
83
84
85
86
87
88
89
90
91
92
93
94
95
96
97
98
99
100

A | B | C | D | E | F | G | H | J | K | L | M

1 | 2 | 3 | 4 | 5 | 6 | 7 | 8

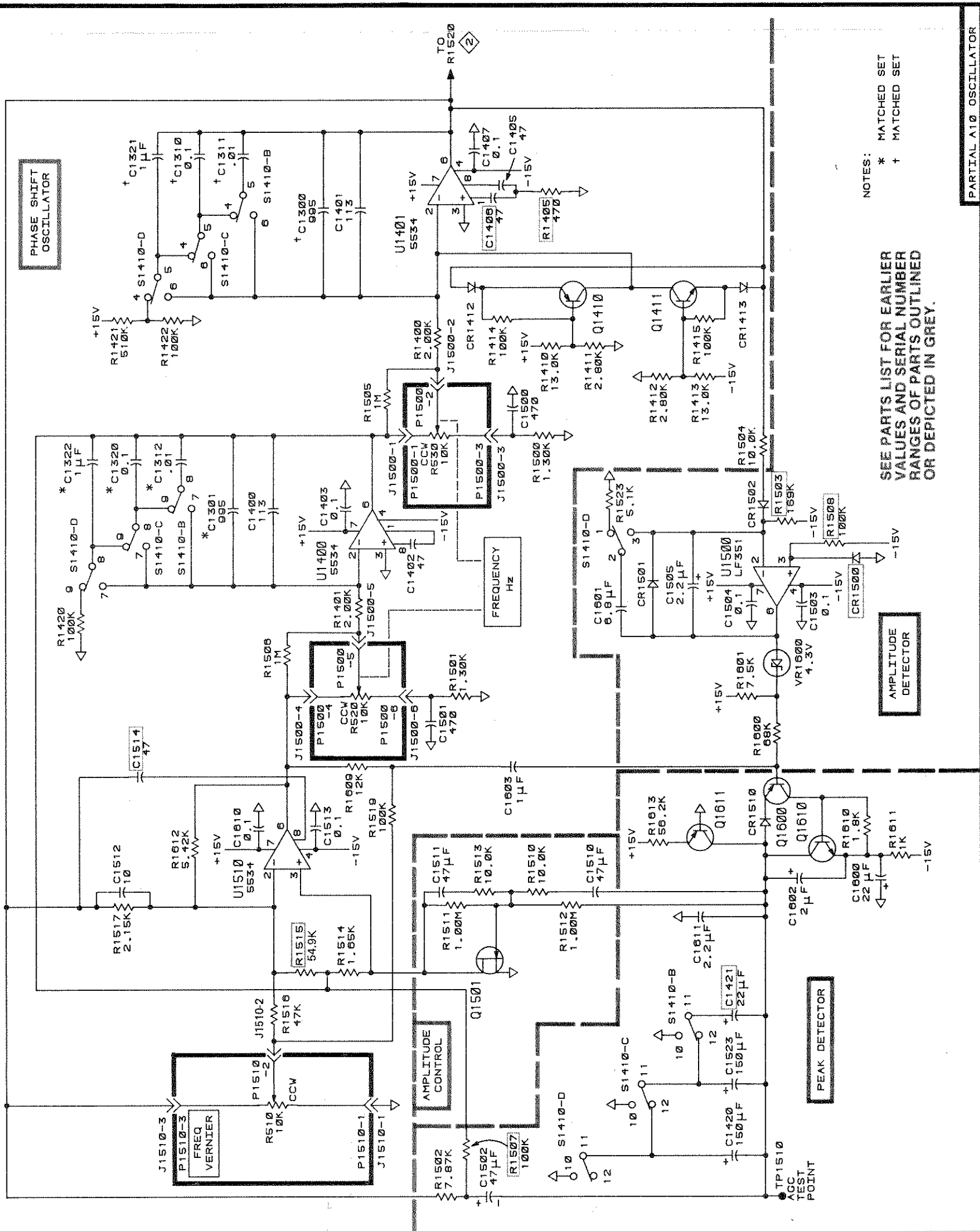

STATIC SENSITIVE DEVICES
SEE MAINTENANCE SECTION

COMPONENT NUMBER EXAMPLE

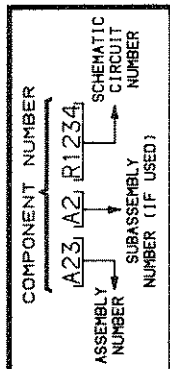

CHASSIS-MOUNTED COMPONENTS HAVE NO ASSEMBLY NUMBER PREFIX - SEE END OF REPLACEABLE ELECTRICAL PARTS LIST

NOTES:
* MATCHED SET
† MATCHED SET

SEE PARTS LIST FOR EARLIER VALUES AND SERIAL NUMBER RANGES OF PARTS OUTLINED OR DEPICTED IN GREY.

AMPLITUDE DETECTOR

PEAK DETECTOR

PARTIAL A10 OSCILLATOR

OSCILLATOR 1

2823-26
REV MAR 1986

SG 505

JP

OSCILLATOR 1 2

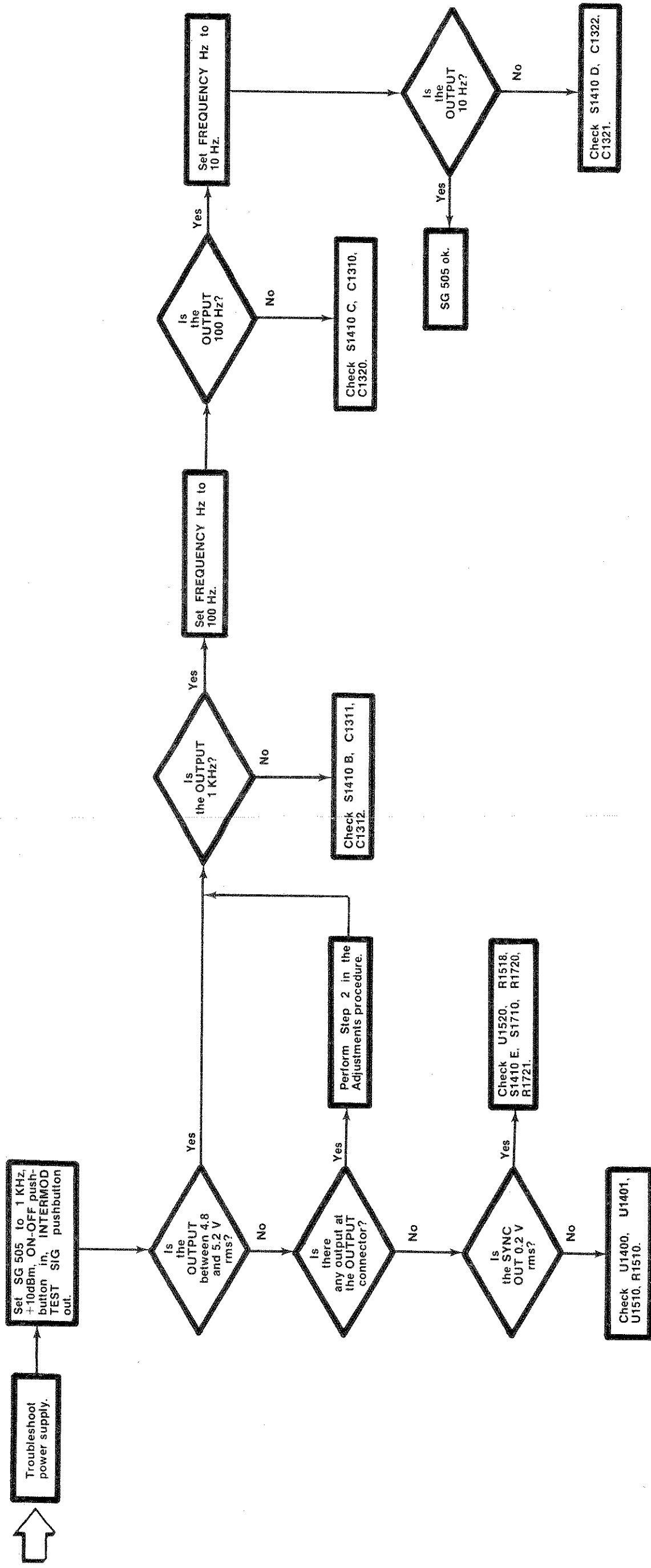





Fig. 8-3. Troubleshooting flow chart—Oscillator

Table 8-3 COMPONENT REFERENCE CHART

P/O A10 ASSY			Output 		
Circuit Number	Schematic Location	Board Location	Circuit Number	Schematic Location	Board Location
C1202	J3	D2	R1201	E2	D1
C1203	F1	D2	R1202	K2	D1
C1520	C7	I5	R1203	J3	D2
C1521	D7	I5	R1204	K3	C1
C1522	B7	I5	R1208	E1	C2
C1524	D6	J5	R1300	E3	E2
C1620	D6	J5	R1301	E3	E2
C1621	D7	J4	R1423	E4	H5
C1622*	D6	J4	R1518	E5	H4
C1720	K6	L6	R1520	C4	H5
CR1200	F2	C1	R1521	D4	H5
			R1522	D5	H5
DS1424	K6	G6	R1524	C7	I5
			R1525	E5	I5
J540	M6	CHASSIS	R1526*	C5	J4
J550	M3	CHASSIS	R1620	B7	J5
J600	M6	CHASSIS	R1621	D6	J5
J1300	C2	E1	R1711	J5	M3
J1520	B3	H5	R1712	K4	M2
			R1720	F4	L5
P1300	C2	CHASSIS	R1721	J6	M5
P1520	B3	CHASSIS	S1410E	E6	G5
			S1410F	L6	G5
Q1300	H2	D1	S1710	J8	L4
Q1301	E2	E1			
Q1620	B7	J5	U1300	E2	E1
			U1520	D6	J5
R1100	L4	B2	U1700	K4	M3
R1104	L5	C1			
R1200	E3	D1	W1300	C3	E1

P/O A10 ASSY also shown on  

*SEE PARTS LIST FOR SERIAL NUMBER RANGES

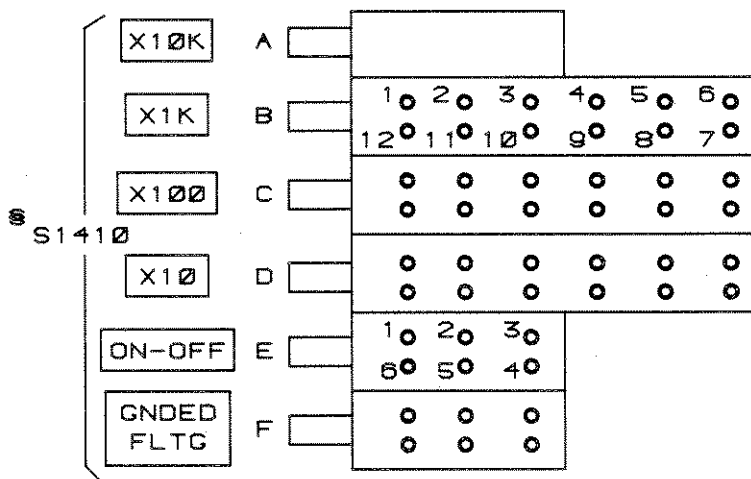

NOTES:

§ VIEWED FROM BACK OF BOARD

A | B | C | D | E | F | H | J | K | L | M

2

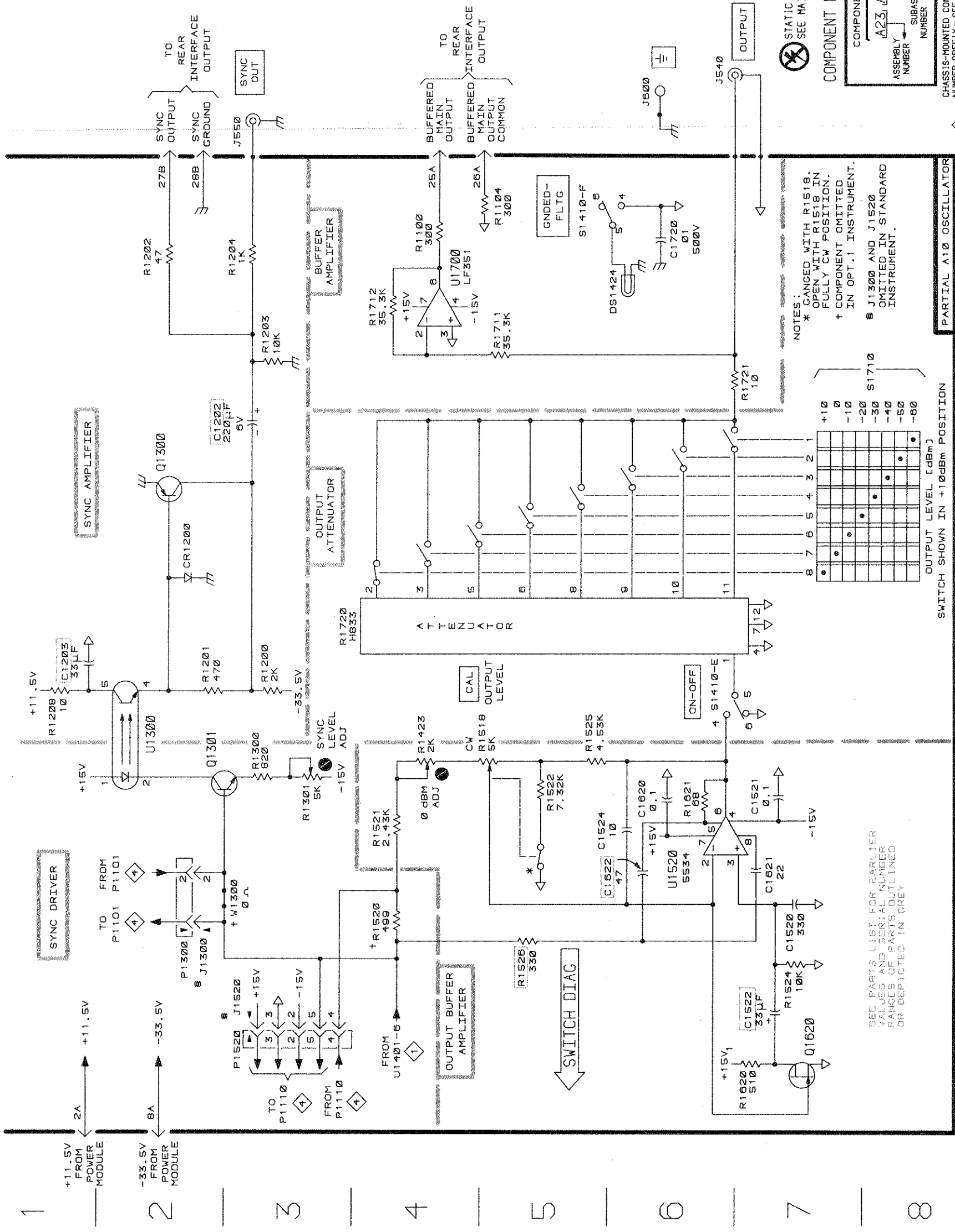

STATIC SENSITIVE DEVICES
SEE MAINTENANCE SECTION

COMPONENT NUMBER EXAMPLE

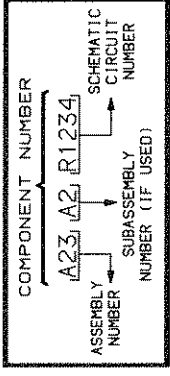

NOTES:

- * GANGED WITH R1518, OPEN WITH R1518 IN FULLY CW POSITION.
- + COMPONENT OMITTED IN OPT. 1 INSTRUMENT.
- § J1300 AND J1520 OMITTED IN STANDARD INSTRUMENT.

SWITCH POSITION	OUTPUT LEVEL [dBm]
1	+10
2	0
3	-10
4	-20
5	-30
6	-40
7	-50
8	-60
9	
10	
11	

OUTPUT SHOWN IN +10dBm POSITION

SEE PARTS LIST FOR EARLIER VALUES AND SERIAL NUMBER RANGES OF PARTS OUTLINED OR DEPICTED IN GREY

CHASSIS-MOUNTED COMPONENTS HAVE NO ASSEMBLY NUMBER PREFIX - SEE END OF REPLACEABLE ELECTRICAL PARTS LIST

2

OUTPUT

2623-27
REV NOV 1985

SG 505

POWER SUPPLY

3

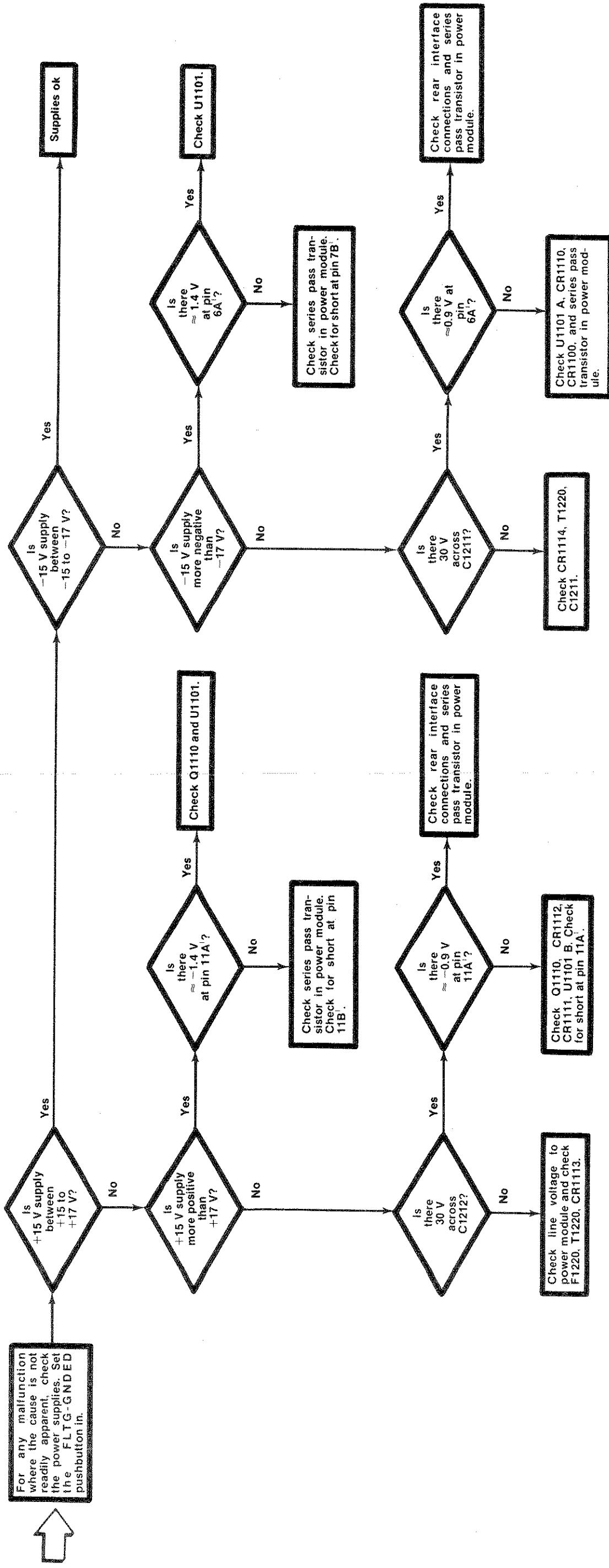



¹ On rear interface connector.

Fig. 8-4. Troubleshooting flow chart—power supply.

**Table 8-4
COMPONENT REFERENCE CHART**

P/O A10 ASSY			Power Supply 		
Circuit Number	Schematic Location	Board Location	Circuit Number	Schematic Location	Board Location
C1100	F7	B2	Q1110	J3	C3
C1101	H2	B2	R1101	E7	B2
C1200	L2	K5	R1102	E2	C2
C1201	L1	C2	R1103	F2	C2
C1210	L8	C3	R1110	J6	B3
C1211	E6	C3	R1111	J2	B3
C1212	E2	D3	R1120	L2	B5
C1316	C7	B4	R1121	L7	B5
CR1100	K7	B2	R1205	F2	C2
CR1110	K7	B3	R1206	F2	C2
CR1111	K2	B3	R1207	L1	C2
CR1112	K2	B3	R1701	L4	M1
CR1113	D2	B3	T1220	C2	C5
CR1114	D6	B3	U1101A	J6	B2
CR1201*†	F3	C2	U1101B	H3	B2
DS510	L4	CHASSIS	VR1201	F3	C2
F1220	B4	C6			

P/O A10 ASSY also shown on  

1
2
3
4
5
6
7
8
9
10
11
12
13
14
15
16
17
18
19
20
21
22
23
24
25
26
27
28
29
30
31
32
33
34
35
36
37
38
39
40
41
42
43
44
45
46
47
48
49
50
51
52
53
54
55
56
57
58
59
60
61
62
63
64
65
66
67
68
69
70
71
72
73
74
75
76
77
78
79
80
81
82
83
84
85
86
87
88
89
90
91
92
93
94
95
96
97
98
99
100
101
102
103
104
105
106
107
108
109
110
111
112
113
114
115
116
117
118
119
120
121
122
123
124
125
126
127
128
129
130
131
132
133
134
135
136
137
138
139
140
141
142
143
144
145
146
147
148
149
150
151
152
153
154
155
156
157
158
159
160
161
162
163
164
165
166
167
168
169
170
171
172
173
174
175
176
177
178
179
180
181
182
183
184
185
186
187
188
189
190
191
192
193
194
195
196
197
198
199
200
201
202
203
204
205
206
207
208
209
210
211
212
213
214
215
216
217
218
219
220
221
222
223
224
225
226
227
228
229
230
231
232
233
234
235
236
237
238
239
240
241
242
243
244
245
246
247
248
249
250
251
252
253
254
255
256
257
258
259
260
261
262
263
264
265
266
267
268
269
270
271
272
273
274
275
276
277
278
279
280
281
282
283
284
285
286
287
288
289
290
291
292
293
294
295
296
297
298
299
300
301
302
303
304
305
306
307
308
309
310
311
312
313
314
315
316
317
318
319
320
321
322
323
324
325
326
327
328
329
330
331
332
333
334
335
336
337
338
339
340
341
342
343
344
345
346
347
348
349
350
351
352
353
354
355
356
357
358
359
360
361
362
363
364
365
366
367
368
369
370
371
372
373
374
375
376
377
378
379
380
381
382
383
384
385
386
387
388
389
390
391
392
393
394
395
396
397
398
399
400
401
402
403
404
405
406
407
408
409
410
411
412
413
414
415
416
417
418
419
420
421
422
423
424
425
426
427
428
429
430
431
432
433
434
435
436
437
438
439
440
441
442
443
444
445
446
447
448
449
450
451
452
453
454
455
456
457
458
459
460
461
462
463
464
465
466
467
468
469
470
471
472
473
474
475
476
477
478
479
480
481
482
483
484
485
486
487
488
489
490
491
492
493
494
495
496
497
498
499
500
501
502
503
504
505
506
507
508
509
510
511
512
513
514
515
516
517
518
519
520
521
522
523
524
525
526
527
528
529
530
531
532
533
534
535
536
537
538
539
540
541
542
543
544
545
546
547
548
549
550
551
552
553
554
555
556
557
558
559
560
561
562
563
564
565
566
567
568
569
570
571
572
573
574
575
576
577
578
579
580
581
582
583
584
585
586
587
588
589
590
591
592
593
594
595
596
597
598
599
600
601
602
603
604
605
606
607
608
609
610
611
612
613
614
615
616
617
618
619
620
621
622
623
624
625
626
627
628
629
630
631
632
633
634
635
636
637
638
639
640
641
642
643
644
645
646
647
648
649
650
651
652
653
654
655
656
657
658
659
660
661
662
663
664
665
666
667
668
669
670
671
672
673
674
675
676
677
678
679
680
681
682
683
684
685
686
687
688
689
690
691
692
693
694
695
696
697
698
699
700
701
702
703
704
705
706
707
708
709
710
711
712
713
714
715
716
717
718
719
720
721
722
723
724
725
726
727
728
729
730
731
732
733
734
735
736
737
738
739
740
741
742
743
744
745
746
747
748
749
750
751
752
753
754
755
756
757
758
759
760
761
762
763
764
765
766
767
768
769
770
771
772
773
774
775
776
777
778
779
780
781
782
783
784
785
786
787
788
789
790
791
792
793
794
795
796
797
798
799
800
801
802
803
804
805
806
807
808
809
810
811
812
813
814
815
816
817
818
819
820
821
822
823
824
825
826
827
828
829
830
831
832
833
834
835
836
837
838
839
840
841
842
843
844
845
846
847
848
849
850
851
852
853
854
855
856
857
858
859
860
861
862
863
864
865
866
867
868
869
870
871
872
873
874
875
876
877
878
879
880
881
882
883
884
885
886
887
888
889
890
891
892
893
894
895
896
897
898
899
900
901
902
903
904
905
906
907
908
909
910
911
912
913
914
915
916
917
918
919
920
921
922
923
924
925
926
927
928
929
930
931
932
933
934
935
936
937
938
939
940
941
942
943
944
945
946
947
948
949
950
951
952
953
954
955
956
957
958
959
960
961
962
963
964
965
966
967
968
969
970
971
972
973
974
975
976
977
978
979
980
981
982
983
984
985
986
987
988
989
990
991
992
993
994
995
996
997
998
999
1000

A | B | C | D | E | F | H | J | K | L | M

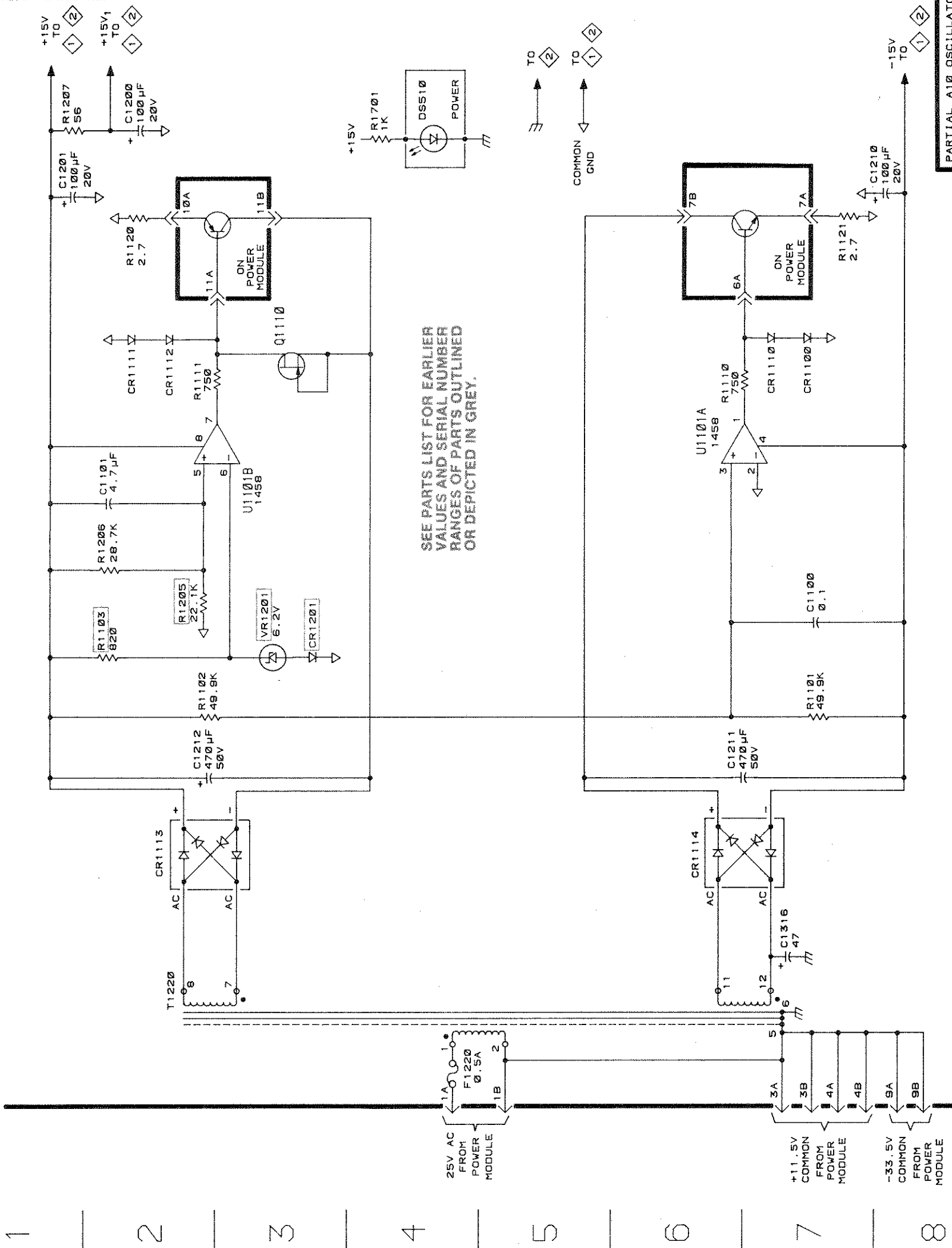

SEE PARTS LIST FOR EARLIER VALUES AND SERIAL NUMBER RANGES OF PARTS OUTLINED OR DEPICTED IN GREY.

COMPONENT NUMBER EXAMPLE

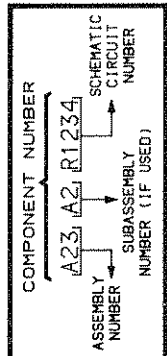

CHASSIS-MOUNTED COMPONENTS HAVE NO ASSEMBLY NUMBER PREFIX - SEE END OF REPLACEABLE ELECTRICAL PARTS LIST

⊗ STATIC SENSITIVE DEVICES SEE MAINTENANCE SECTION

PARTIAL A10 OSCILLATOR

POWER SUPPLY 3 JP

2823-28 REV MAY 1985

SG 505

PARTS LOCATION GRID

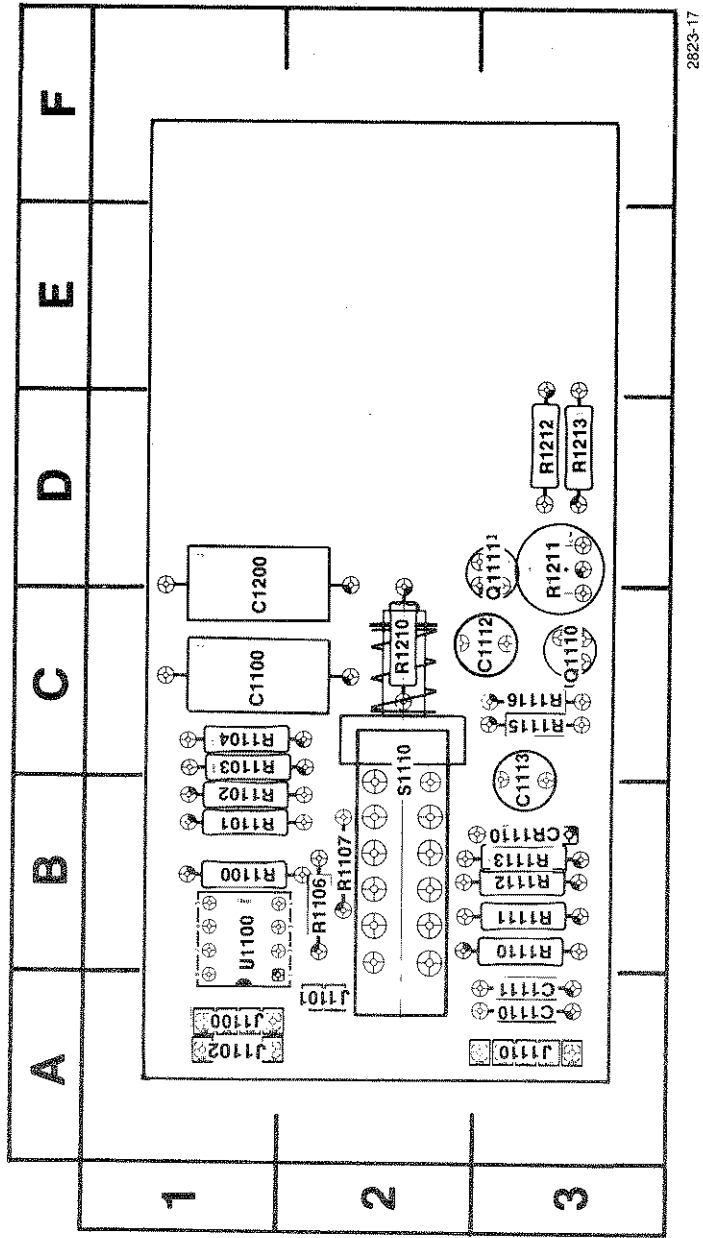

2823-17

Table 8-5
COMPONENT REFERENCE CHART

A11 ASSY				IMD Option 4			
Circuit Number	Schematic Location	Board Location	Circuit Number	Schematic Location	Board Location		
C1100	H4	C1	R1100	E2	B1		
C1110	B4	A3	R1101	F4	B1		
C1111	B5	A3	R1102	H4	B1		
C1112	E7	C3	R1103	E4	C1		
C1113	E7	B3	R1104	E3	C1		
C1200	E4	D1	R1105	J3	B2		
CR1110	J4	B3	R1106	J4	B2		
J1100	D5	A1	R1107	K1	B3		
J1101	B7	A2	R1110	K2	B3		
J1101	M7	A2	R1111	L2	B3		
J1102	D5	A1	R1112	K3	B3		
J1110	B2	A3	R1115	J7	C3		
J1110	B4	A3	R1116	E7	C3		
J1110	B5	A3	R1210	C6	C2		
J1110	M1	A3	R1211	H6	D3		
J1110	M1	A3	R1212	H6	D3		
J1110	M1	A3	R1213	H5	D3		
P1100	D5	JUMPER FOR J1100 or J1102	S1110	C2	C2		
Q1110	J6	C3	S1110	J2	C2		
Q1111	C7	D3	S1110	K7	C2		
			S1110	L2	C2		
			U1100	H3	B1		

Fig. 8-5. IMD option board (A11).

COMPONENT NUMBER EXAMPLE

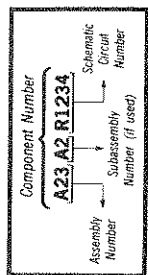

Static Sensitive Devices
See Maintenance Section

@

A | B | C | D | E | F | H | J | K | L | M

1 — 2 — 3 — 4 — 5 — 6 — 7 — 8

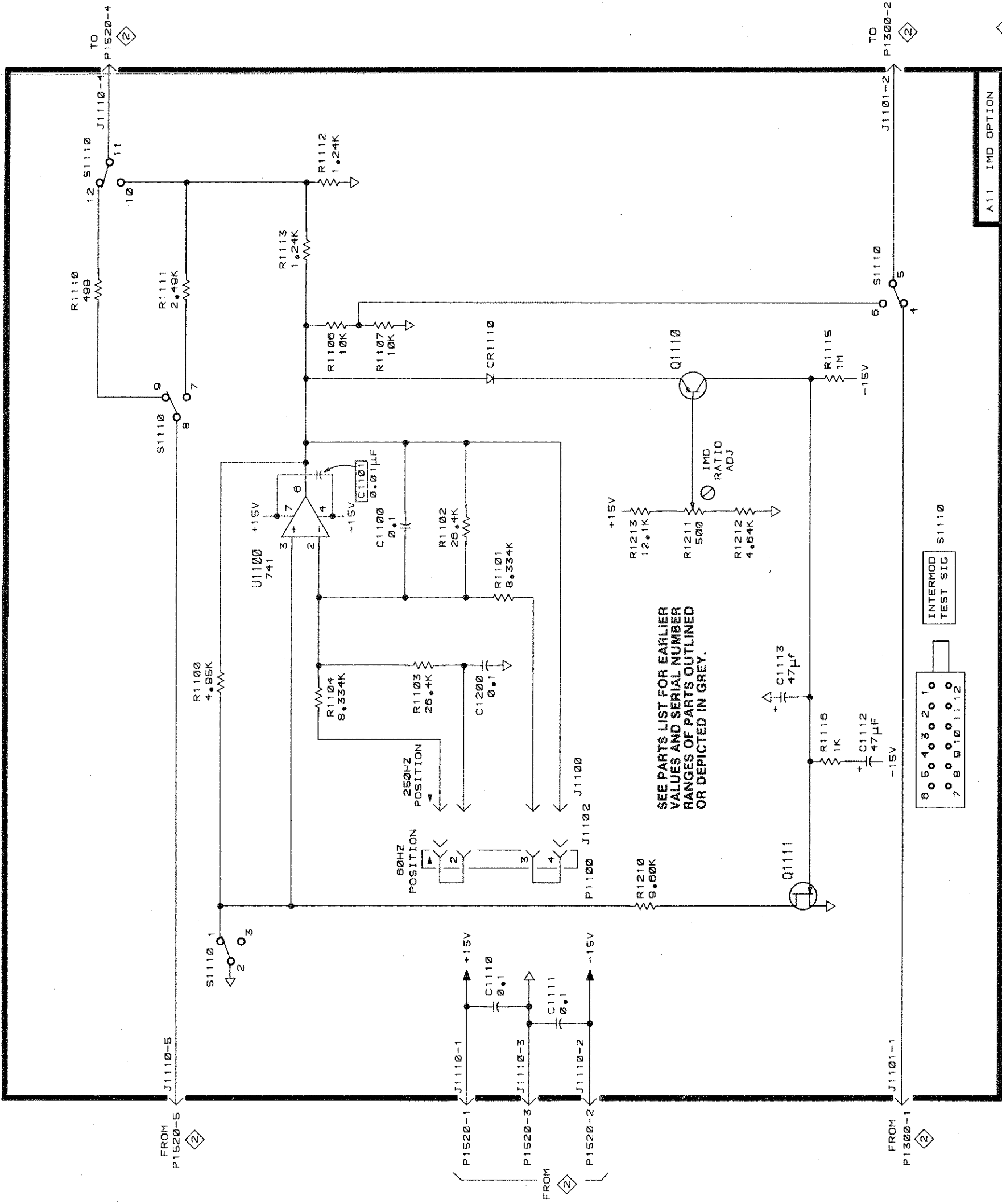

⊗ Static Sensitive Devices
See Maintenance Section

COMPONENT NUMBER EXAMPLE

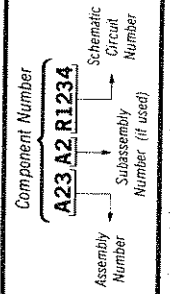

Chassis-mounted components have an Assembly Number prefix—see end of Replaceable Electrical Parts List.

A11 IMD OPTION

IMD OPTION

2023-29

SG 505

REV A MAY 1980

JP

INTERMOD TEST SIC S1110

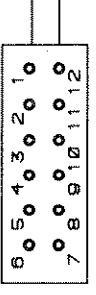

ADJUSTMENT LOCATIONS

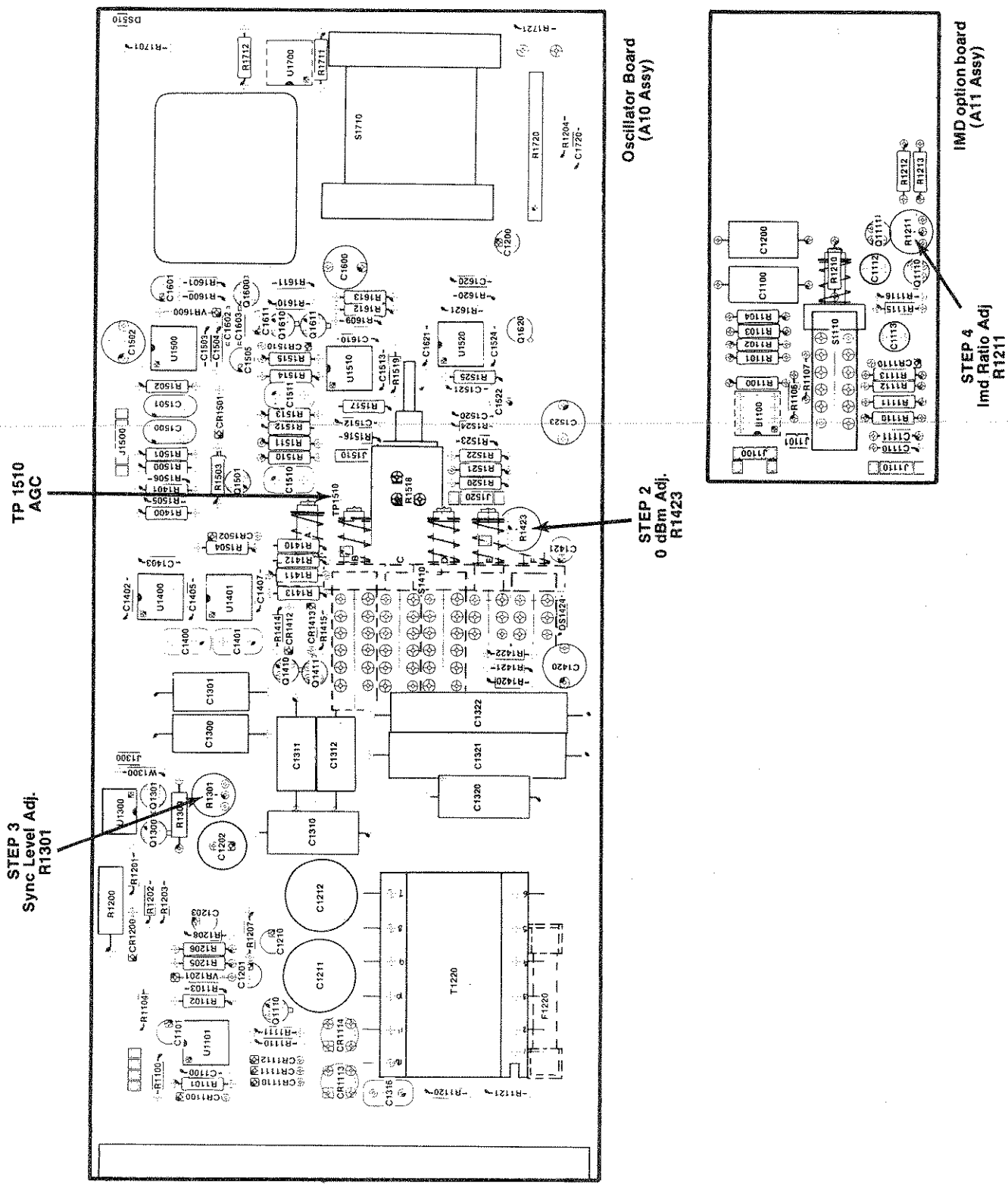

Fig. 8-6. Adjustment locations.

REPLACEABLE MECHANICAL PARTS

PARTS ORDERING INFORMATION

Replacement parts are available from or through your local Tektronix, Inc. Field Office or representative.

Changes to Tektronix instruments are sometimes made to accommodate improved components as they become available, and to give you the benefit of the latest circuit improvements developed in our engineering department. It is therefore important, when ordering parts, to include the following information in your order: Part number, instrument type or number, serial number, and modification number if applicable.

If a part you have ordered has been replaced with a new or improved part, your local Tektronix, Inc. Field Office or representative will contact you concerning any change in part number.

Change information, if any, is located at the rear of this manual.

SPECIAL NOTES AND SYMBOLS

X000 Part first added at this serial number
00X Part removed after this serial number

FIGURE AND INDEX NUMBERS

Items in this section are referenced by figure and index numbers to the illustrations.

INDENTATION SYSTEM

This mechanical parts list is indented to indicate item relationships. Following is an example of the indentation system used in the description column.

```

1 2 3 4 5           Name & Description
Assembly and/or Component
Attaching parts for Assembly and/or Component
    * * * * *
Detail Part of Assembly and/or Component
Attaching parts for Detail Part
    * * * * *
Parts of Detail Part
Attaching parts for Parts of Detail Part
    * * * * *
  
```

Attaching Parts always appear in the same indentation as the item it mounts, while the detail parts are indented to the right. Indented items are part of, and included with, the next higher indentation. The separation symbol - * * - * - * - indicates the end of attaching parts.

Attaching parts must be purchased separately, unless otherwise specified.

ITEM NAME

In the Parts List, an Item Name is separated from the description by a colon (:). Because of space limitations, an Item Name may sometimes appear as incomplete. For further Item Name identification, the U. S. Federal Cataloging Handbook H6-1 can be utilized where possible.

ABBREVIATIONS

INCH	ELECTRN	ELEC	IN	INCH	SE	SINGLE END
NUMBER SIZE	ELEC	ELECTRICAL	INCAND	INCANDESCENT	SECT	SECTION
ACTR	ELECTLT	ELECTROLYTIC	INSUL	INSULATOR	SEMICOND	SEMICONDUCTOR
ADPTR	ELEM	ELEMENT	INTL	INTERNAL	SHLD	SHIELD
ALIGN	EPL	ELECTRICAL PARTS LIST	LPHLDR	LAMPHOLDER	SHLDR	SHOULDERED
AL	EQPT	EQUIPMENT	MACH	MACHINE	SKT	SOCKET
ASSEM	EXT	EXTERNAL	MECH	MECHANICAL	SL	SLIDE
ASSY	FIL	FILLISTER HEAD	MTG	MOUNTING	SLFLKG	SELF-LOCKING
ATTEN	FLEX	FLEXIBLE	NIP	NIPPLE	SLVG	SLEEVING
AWG	FLH	FLAT HEAD	NON WIRE	NOT WIRE WOUND	SPR	SPRING
BD	FLTR	FILTER	QBD	ORDER BY DESCRIPTION	SQ	SQUARE
BRKT	FR	FRAME or FRONT	OD	OUTSIDE DIAMETER	SST	STAINLESS STEEL
BRS	FSTNR	FASTENER	OVH	OVAL HEAD	STL	STEEL
BRZ	FT	FOOT	PH BRZ	PHOSPHOR BRONZE	SW	SWITCH
BSHG	FXD	FIXED	PL	PLAIN or PLATE	T	TUBE
CAB	GSKT	GASKET	PLSTC	PLASTIC	TERM	TERMINAL
CAP	HDL	HANDLE	PN	PART NUMBER	THD	THREAD
CER	HEX	HEXAGON	PNH	PAN HEAD	THK	THICK
CHAS	HEX HD	HEXAGONAL HEAD	PWR	POWER	TNSN	TENSION
CKT	HEX SOC	HEXAGONAL SOCKET	RCPT	RECEPTACLE	TPG	TAPPING
COMP	HLCP	HELICAL COMPRESSION	RES	RESISTOR	TRH	TRUSS HEAD
CONN	HLEXT	HELICAL EXTENSION	RGD	RIGID	V	VOLTAGE
COV	HV	HIGH VOLTAGE	RLF	RELIEF	VAR	VARIABLE
CPLG	IC	INTEGRATED CIRCUIT	RTNR	RETAINER	W/	WITH
CRT	ID	INSIDE DIAMETER	SCH	SOCKET HEAD	WSHR	WASHER
DEG	IDNT	IDENTIFICATION	SCOPE	OSCILLOSCOPE	XFMR	TRANSFORMER
DWR	IMPLR	IMPELLER	SCR	SCREW	XSTR	TRANSISTOR

CROSS INDEX - MFR. CODE NUMBER TO MANUFACTURER

Mfr. Code	Manufacturer	Address	City, State, Zip Code
01536	TEXTRON INC CAMCAR DIV	1818 CHRISTINA ST	ROCKFORD IL 61108
06383	SEMS PRODUCTS UNIT		
09772	PANDUIT CORP WEST COAST LOCKMASHER CO INC	17301 RIDGELAND 16730 E JOHNSON DRIVE P O BOX 3588	TINLEY PARK IL 60477 CITY OF INDUSTRY CA 91744
09922	BURNOY CORP	RICHARDS AVE	NORMALK CT 06852
12327	FREEMAY CORP	9301 ALLEN DR	CLEVELAND OH 44125
22526	DU PONT E I DE NEMOURS AND CO INC DU PONT CONNECTOR SYSTEMS	30 HUNTER LANE	CAMP HILL PA 17011
71159	BRISTOL SOCKET SCREM CO		MATERBURY CT
73743	FISCHER SPECIAL MFG CO	446 MORGAN ST	CINCINNATI OH 45206
75915	LITTELFUSE INC	800 E NORTHWEST HWY	DES PLAINES IL 60016
77900	SHAKEPROOF DIV OF ILLINOIS TOOL WORKS	SAINT CHARLES RD	ELGIN IL 60120
78189	ILLINOIS TOOL WORKS INC SHAKEPROOF DIVISION	ST CHARLES ROAD	ELGIN IL 60120
79136	WALDES KOHINDOR INC	47-16 AUSTEL PLACE	LONG ISLAND CITY NY 11101
80009	TEKTRONIX INC	4900 S W GRIFFITH DR P O BOX 500	BEAVERTON OR 97077
83385	MICRODOT MANUFACTURING INC GREER-CENTRAL DIV	3221 W BIG BEAVER RD	TROY MI 48098
83486	ELCO INDUSTRIES INC	1101 SAMUELSON RD	ROCKFORD IL 61101
86928	SEASTROM MFG CO INC	701 SONORA AVE	GLENDALE CA 91201
93907	TEXTRON INC CAMCAR DIV	600 18TH AVE	ROCKFORD IL 61101
K0099	JACKSON BROTHERS (LONDON) LTD	258 BROADWAY	NEW YORK NY 10007
TK0392	NORTHWEST FASTENER SALES INC	7923 SW CIRRHUS DRIVE	BEAVERTON OR 97005
TK0433	PORTLAND SCREM CO	6520 N BASIN	PORTLAND OR 97217
TK0435	LEMIS SCREM CO	4114 S PEORIA	CHICAGO IL 60609
TK0507	O HARA METAL PRODUCTS CO	542 BRANNAN ST	SAN FRANCISCO CA 94107

Fig. & Index No.	Tektronix Part No.	Serial/Assembly No.		Qty	12345 Name & Description	Mfr.	
		Effective	Dscont			Code	Mfr. Part No.
1-1	337-1399-04	8010100	8042239	2	SHIELD,ELEC:SIDE (FOR REPLACEMENT PART SEE FIG 2)	80009	337-1399-04
-2	366-1007-05			1	KNOB:GY,0.252 ID X 1.17 00 X 0.7 H	80009	366-1007-05
	213-0153-00			2	.SETSCREM:5-40 X 0.125,STL	TK0392	ORDER BY DESCR
-3	354-0557-04			1	RING,KNOB SKIRT:CLEAR,1.875 00 (ATTACHING PARTS)	80009	354-0557-04
-4	211-0030-00			2	SCREM,MACHINE:2-56 X 0.25,FLH,82 DEG,STL (END ATTACHING PARTS)	TK0435	ORDER BY DESCR
-5	210-0978-00	8010100	8010189	1	WASHER,FLAT:0.375 ID X 0.5 00 X 0.024,STL (STANDARD ONLY)	12327	ORDER BY DESCR
	210-0051-00	8010190	8042239	1	WASHER,LOCK:0.418 ID INTL,0.022 THK,STL (STANDARD ONLY)	77900	1220-08-00-0541C
	210-0978-00	8010100	8010239	1	WASHER,FLAT:0.375 ID X 0.5 00 X 0.024,STL (OPTION 01 ONLY)	12327	ORDER BY DESCR
	210-0051-00	8010240	8042189	1	WASHER,LOCK:0.418 ID INTL,0.022 THK,STL (OPTION 01 ONLY)	77900	1220-08-00-0541C
-6	366-0494-05			1	KNOB:GY,0.127 ID X 0.5 00 X 0.531 H	80009	366-0494-05
	213-0246-00			1	.SETSCREM:5-40 X 0.094,STL	71159	ORDER BY DESCR
-7	-----			1	RES.,VAR,NONMIR:(SEE R510 REPL) (ATTACHING PARTS)		
-8	210-0583-00			1	NUT,PLAIN,HEX:0.25-32 X 0.312,BRS CD PL	73743	2X-20319-402
-9	210-0940-00			1	WASHER,FLAT:0.25 ID X 0.375 00 X 0.02,STL (END ATTACHING PARTS)	12327	ORDER BY DESCR
-10	366-1031-08			1	KNOB:GY,CAL,0.127 ID X 0.392 00 X 0.466 H	80009	366-1031-08
	213-0246-00			1	.SETSCREM:5-40 X 0.094,STL	71159	ORDER BY DESCR
-11	366-1170-03			1	KNOB:GY,0.252 ID X 0.706 00 X 0.6 H	80009	366-1170-03
	213-0153-00			2	.SETSCREM:5-40 X 0.125,STL	TK0392	ORDER BY DESCR
-12	358-0029-00			1	BSHG,MACH THD:0.375-32 X 0.5 HEX,BRS NP (ATTACHING PARTS)	80009	358-0029-00
-13	210-0590-00			1	NUT,PLAIN,HEX:0.375-32 X 0.438 BRS CD PL	73743	28269-402
-14	210-0978-00	8010100	8042239	1	WASHER,FLAT:0.375 ID X 0.5 00 X 0.024,STL (END ATTACHING PARTS)	12327	ORDER BY DESCR
-15	344-0195-01			1	CLIP,ELECTRICAL:GROUNDING,PH BRZ ALBALOY PL	80009	344-0195-01
-16	-----			1	CONNECTOR,RCPT:(SEE J550 REPL)		
-17	366-1690-00	8010100	8042239	1	KNOB,LATCH:SIL GY,0.53 X 0.23 X 1.059 (FOR REPLACEMENT PARTS SEE FIG 2)	80009	366-1690-00
-18	-----			1	CONNECTOR,RCPT:(SEE J540 REPL)		
-19	355-0170-00	8010100	8042239	1	STUD,SHLDR&STEP:BINDING POST	80009	355-0170-00
	355-0239-00	8042240		1	STUD,SHOULDERED:BINDING POST,BRASS (ATTACHING PARTS)	80009	355-0239-00
-20	220-0633-00			1	NUT,PLAIN,KNURL:0.25-28 X 0.375 00,BRS NP (END ATTACHING PARTS)	80009	220-0633-00
-21	333-2599-00	8010100	8042239	1	PANEL,FRONT: STANDARD ONLY (FOR REPLACEMENT PARTS SEE FIG 2)	80009	333-2599-00
	333-2599-01	8010100	8042189	1	PANEL,FRONT: (OPTION 01 ONLY) (FOR REPLACEMENT PARTS SEE FIG 2) (ATTACHING PARTS)	80009	333-2599-01
-22	129-0510-00	8010100	8042239	2	SPACER,POST:0.156 L,2-56 THRU,BRS,CU SN ZN PL,0.125 HEX	80009	129-0510-00
-23	210-0053-00	8010100	8042239	2	WASHER,LOCK:#2 SPLIT,0.02 THK STL (END ATTACHING PARTS)	78189	ORDER BY DESCR
-24	105-0719-00	8010100	8042239	1	LATCH,RETAINING:PLUG-IN (FOR REPLACEMENT PARTS SEE FIG 2) (ATTACHING PARTS)	80009	105-0719-00
-25	213-0113-00	8010100	8042239	1	SCREEN,TPG,TF:2-32 X 0.312,TYPE B,PNH,STL (END ATTACHING PARTS)	93907	ORDER BY DESCR
-26	105-0718-01	8010100	8042239	1	BAR,LATCH RLSE: (FOR REPLACEMENT PARTS SEE FIG 2)	80009	105-0718-01
-27	352-0157-00			1	LAMPHOLDER:(1)T-2 UNBASED,WHITE	80009	352-0157-00
-27.1	210-1258-00			1	WASHER,FLAT:0.265 ID X 0.375 00 X 0.32,AL	86928	76430-000
-28	200-0935-00			1	BASE,LAMPHOLDER:0.29 00 X 0.19 L,BK PLSTC	80009	200-0935-00
-29	-----			1	RES.,VAR,MM:(SEE R520,R530 REPL) (ATTACHING PARTS)		
-30	210-0413-00			1	NUT,PLAIN,HEX:0.375-32 X 0.5,BRS CD PL	73743	3145-402
-31	210-0021-00	8010100	8010189	1	WASHER,LOCK:0.476 ID,INTL,0.018 THK,STL	78189	1222-01

Replaceable Mechanical Parts - SG 505

Fig. & Index No.	Tektronix Part No.	Serial/Assembly No. Effective	Dscont	Qty	12345 Name & Description	Mfr. Code	Mfr. Part No.
1-	210-0012-00	8010190		1	(STANDARD ONLY) MASHER, LOCK:0.384 ID,INTL,0.022 THK,STL	09772	ORDER BY DESCR
	210-0021-00	8010100	8010239	1	(STANDARD ONLY) MASHER, LOCK:0.476 ID,INTL,0.018 THK,STL	78189	1222-01
	210-0012-00	8010240		1	(OPTION 01 ONLY) MASHER, LOCK:0.384 ID,INTL,0.022 THK,STL	09772	ORDER BY DESCR
-32	407-1274-00	8010100	8042239	1	(END ATTACHING PARTS) BRACKET,VAR RES:ALUMINUM	80009	407-1274-00
	407-2975-00	8042240		1	BRACKET,VAR RES:ALUMINUM	80009	407-2975-00
-33	211-0559-00	8010100	8042239	1	(ATTACHING PARTS) SCREW,MACHINE:6-32 X 0.375,FLH,100 DEG	TK0435	1593-300
	211-0658-00	8042240		1	SCR,ASSEM MSHR:6-32 X 0.312,PNH,STL,POZ	78189	551-060545-0X
-34	401-0161-00			1	(END ATTACHING PARTS) DR, TURNS RDCN:6 TO 1	K0099	4511/DAF
-35	213-0138-00			2	(ATTACHING PARTS) SCREW,TPG,TF:4-24 X 0.188,TYPE B,PNH,STL	TK0435	ORDER BY DESCR
	213-0020-00	8010190		2	(END ATTACHING PARTS) SETSCREW:6-32 X 0.125,STL	TK0433	ORDER BY DESCR
	213-0020-00	8020250		2	(STANDARD ONLY) SETSCREW:6-32 X 0.125,STL	TK0433	ORDER BY DESCR
-36	386-4274-00	8010100	8042239	1	(OPTION 01 ONLY) SUBPANEL,FRONT:	80009	386-4274-00
-37	213-0123-00	8010100	8042239	3	(ATTACHING PARTS) SCREW,TPG,TF:6-32 X 0.375,SPCL TYPE,FLH	93907	234-21940-026
-38	337-2706-00	8010100	8042239	1	(FOR REPLACEMENT PART SEE FIG 2) SHIELD,ELEC:REAR SUBPANEL,AL	80009	337-2706-00
-39	366-1512-00			6	(END ATTACHING PARTS) PUSH BUTTON:SIL GY,0.18 SQ X 0.83	80009	366-1512-00
	366-1512-00			7	PUSH BUTTON:SIL GY,0.18 SQ X 0.83	80009	366-1512-00
-40	384-1370-00			6	(OPTION 01 ONLY) EXTENSION SHAFT:4.68 L,MOLDED PLASTIC	80009	384-1370-00
-41	384-1292-00			1	EXTENSION SHAFT:2.417 L,GL FILLED NYLON	80009	384-1292-00
-42	-----			1	(OPTION 01 ONLY) .CKT BOARD ASSY:OSCILLATOR(SEE A10 REPL)		
-43	213-0146-00			4	(ATTACHING PARTS) SCREW,TPG,TF:6-20 X 0.312,TYPE B,PNH,STL	83385	ORDER BY DESCR
-44	-----			1	(END ATTACHING PARTS) .CKT BOARD ASSY:IMD(SEE A11 REPL)		
-45	211-0097-00			2	(OPTION 01 ONLY) .ATTACHING PARTS)	TK0435	ORDER BY DESCR
-46	-----			13	(END ATTACHING PARTS) .CKT BOARD ASSY INCLUDES: ..TERMINAL,PIN:(SEE A11J1100,A11J1101, ..A11J1110 REPL)		
-47	131-1207-00			1	..BUS CONDUCTOR:1.25 L X 26 AWG WIRE	80009	131-1207-00
-48	-----			1	..SMITCH,PUSH:(SEE A11S1110 REPL)		
-49	361-0411-00			2	..SPACER,PUSH SM:0.109 L,BLUE POLYCARBONATE	80009	361-0411-00
-50	136-0514-00	8010100	8031969	1	..SKT,PL-IN ELEK:MICROCIRCUIT,8 DIP	09922	D1LB8P-108
	136-0514-00	8010100	8031979	1	..(STANDARD ONLY) ..SKT,PL-IN ELEK:MICROCIRCUIT,8 DIP	09922	D1LB8P-108
-51	384-0496-00			1	..(OPTION 01 ONLY) EXTENSION SHAFT:4.82 L X 0.123 OD,EPOXY-GL	80009	384-0496-00
-52	211-0678-00			4	SM CAM ACTR ASSY:(SEE A10S1710 REPL) (ATTACHING PARTS)	01536	ORDER BY DESCR
-53	200-2426-00			1	(END ATTACHING PARTS) ACTUATOR ASSY INCLUDES: ..COVER,CAM SM:8 ELEMENTS	80009	200-2426-00
-54	211-0678-00			4	..(ATTACHING PARTS) ..SCR,ASSEM MSHR:4-40 X 0.281,PNH,STL,POZ	01536	ORDER BY DESCR
-55	354-0390-00			1	..(END ATTACHING PARTS) ..RING,RETAINING:BASIC EXT,U/O 0.375 DIA	79136	5100-37-2D
-56	210-0406-00			7	..NUT,PLAIN,HEX:4-40 X 0.188,BRS CD PL	73743	12161-50

Fig. & Index No.	Tektronix Part No.	Serial/Assembly No. Effective	Dscont	Qty	12345 Name & Description	Mfr. Code	Mfr. Part No.
1-57	131-0963-00			1	..CONTACT,ELEC:GROUNDING,PH BRZ,M/BRACKET	TK0507	ORDER BY DESCR
-58	214-1139-02			2	..SPRING,FLAT:0.885 X 0.156 CU BE GRN CLR	80009	214-1139-02
-59	214-1752-00			2	..ROLLER,DETENT:0.125 00 X 0.16,SST	80009	214-1752-00
-60	401-0180-00			1	..BEARING,CAM SM:FR/REAR,0.8/0.83 DIA	80009	401-0180-00
-61	401-0178-01			1	..BEARING,CAM SM:CENTER REAR,0.378 ID,PLSTC	80009	401-0178-01
-62	384-0878-18			1	..SHAFT,CAM SM:OUTER CNCTRC,M/DRVR,TIME/CM	80009	384-0878-18
-63	105-0836-00			1	..ACTUATOR,CAM SM:ATTENUATOR	80009	105-0836-00
-64	376-0051-00			1	..CPLG,SHAFT,FLEX:0.127 ID X 0.375 00	80009	376-0051-00
	131-0963-00			1	..CONTACT,ELEC:GROUNDING,PH BRZ,M/BRACKET	TK0507	ORDER BY DESCR
-65	136-0514-00	8010100	8031969	7	..SKT,PL-IN ELEC:MICROCIRCUIT,8 DIP	09922	D1L88P-108
					..(STANDARD ONLY)		
	136-0727-00	8031970		4	..SKT,PL-IN ELEC:MICROCKT,8 CONTACT	09922	D1L88P-108
					..(STANDARD ONLY)		
	136-0514-00	8010100	8031979	7	..SKT,PL-IN ELEC:MICROCIRCUIT,8 DIP	09922	D1L88P-108
					..(OPTION 01 ONLY)		
	136-0727-00	8031980		4	..SKT,PL-IN ELEC:MICROCKT,8 CONTACT	09922	D1L88P-108
					..(OPTION 01 ONLY)		
-66	344-0326-00			2	..CLIP,ELECTRICAL:FUSE,BRASS	75915	102071
-67	-----			1	..LINK,TERM.CONNE:(SEE A10M1300 REPL)		
-68	-----			1	..RES.,VAR,NONMIR:(SEE A10R1518 REPL)		
					..(ATTACHING PARTS)		
-69	210-0583-00			1	..NUT,PLAIN,HEX:0.25-32 X 0.312,BRS CD PL	73743	2X-20319-402
-70	210-0223-00			1	..TERMINAL,LUG:0.26 ID,LOCKING,BRZ TIN PL	86928	5441-37
-71	210-0905-00			1	..WASHER,FLAT:0.256 ID X 0.438 00 X 0.05	83385	ORDER BY DESCR
					..(END ATTACHING PARTS)		
-72	361-0515-00			1	..SPACER,SWITCH:0.176 L,ACETAL	80009	361-0515-00
-73	-----			1	..TERM.SET PIN:(SEE A10J1500,A10J1510 REPL)		
-74	136-0252-07			3	..SOCKET,PIN CONN:M/O DIMPLE	22526	75060-012
-75	131-0604-00			8	..CONTACT,ELEC:CKT BD SM,SPR,CU BE	80009	131-0604-00
-76	-----			1	..TERM,TEST POINT:(SEE A10TP1510 REPL)		
-77	334-2990-00			1	..MARKER,IDENT:MKD CAUTION	80009	334-2990-00
-78	-----			1	..SWITCH,PUSH:(SEE A10S1410 REPL)		
-79	361-0411-00			4	..SPACER,PUSH SM:0.109 L,BLUE POLYCARBONATE	80009	361-0411-00
	346-0120-00			1	..STRAP,TIEDOWN,E:5.5 L MIN,PLASTIC	06383	SST1.5M
-80	351-0612-00			2	GUIDE,CKT BOARD:NYLON,1.0 L	80009	351-0612-00
-81	386-4278-00	8010100	8042239	1	SUPPORT,FRAME:REAR,AL	80009	386-4278-00
					(FOR REPLACEMENT PART SEE FIG 2)		
					(ATTACHING PARTS)		
-82	213-0146-00			2	SCREW,TPG,TF:6-20 X 0.312,TYPE B,PNH,STL	83385	ORDER BY DESCR
-83	386-3657-01			2	SUPPORT,PLUG-IN:	93907	ORDER BY DESCR
					(END ATTACHING PARTS)		
-84	214-1061-00	8010100	8042239	1	CONTACT,ELEC:GROUNDING,CU BE	80009	214-1061-00
					(FOR REPLACEMENT PART SEE FIG 2)		
-85	426-0725-05	8010100	8042239	1	FR SECT,PLUG-IN:TOP	80009	426-0725-05
					(FOR REPLACEMENT PART SEE FIG 2)		
-86	426-0724-09	8010100	8042239	1	FR SECT,PLUG-IN:BOTTOM	80009	426-0724-09
					(FOR REPLACEMENT PART SEE FIG 2)		
-87	-----			1	CA ASSY,SP,ELEC:(SEE P1510 REPL)		
	352-0161-03			1	..HLDR,TERM CONN:3 WIRE,ORANGE	80009	352-0161-03
-88	-----			1	CA ASSY,SP,ELEC:(SEE P1500 REPL)		
	352-0164-06			1	..HLDR,TERM CONN:6 WIRE,BLUE	80009	352-0164-06
-89	-----			1	CA ASSY,SP,ELEC:(SEE P1101 REPL)		
					(OPTION 01 ONLY)		
	352-0169-02			2	..HLDR,TERM CONN:2 WIRE,RED	80009	352-0169-02
-90	-----			1	CA ASSY,SP,ELEC:(SEE P1110 REPL)		
					(OPTION 01 ONLY)		
	352-0163-05			2	..HLDR,TERM CONN:5 WIRE,GREEN	80009	352-0163-05

1
2
3
4
5
6
7
8
9
10
11
12
13
14
15
16
17
18
19
20
21
22
23
24
25
26
27
28
29
30
31
32
33
34
35
36
37
38
39
40
41
42
43
44
45
46
47
48
49
50
51
52
53
54
55
56
57
58
59
60
61
62
63
64
65
66
67
68
69
70
71
72
73
74
75
76
77
78
79
80
81
82
83
84
85
86
87
88
89
90
91
92
93
94
95
96
97
98
99
100

FIG. 1 EXPLODED VIEW

SG 505

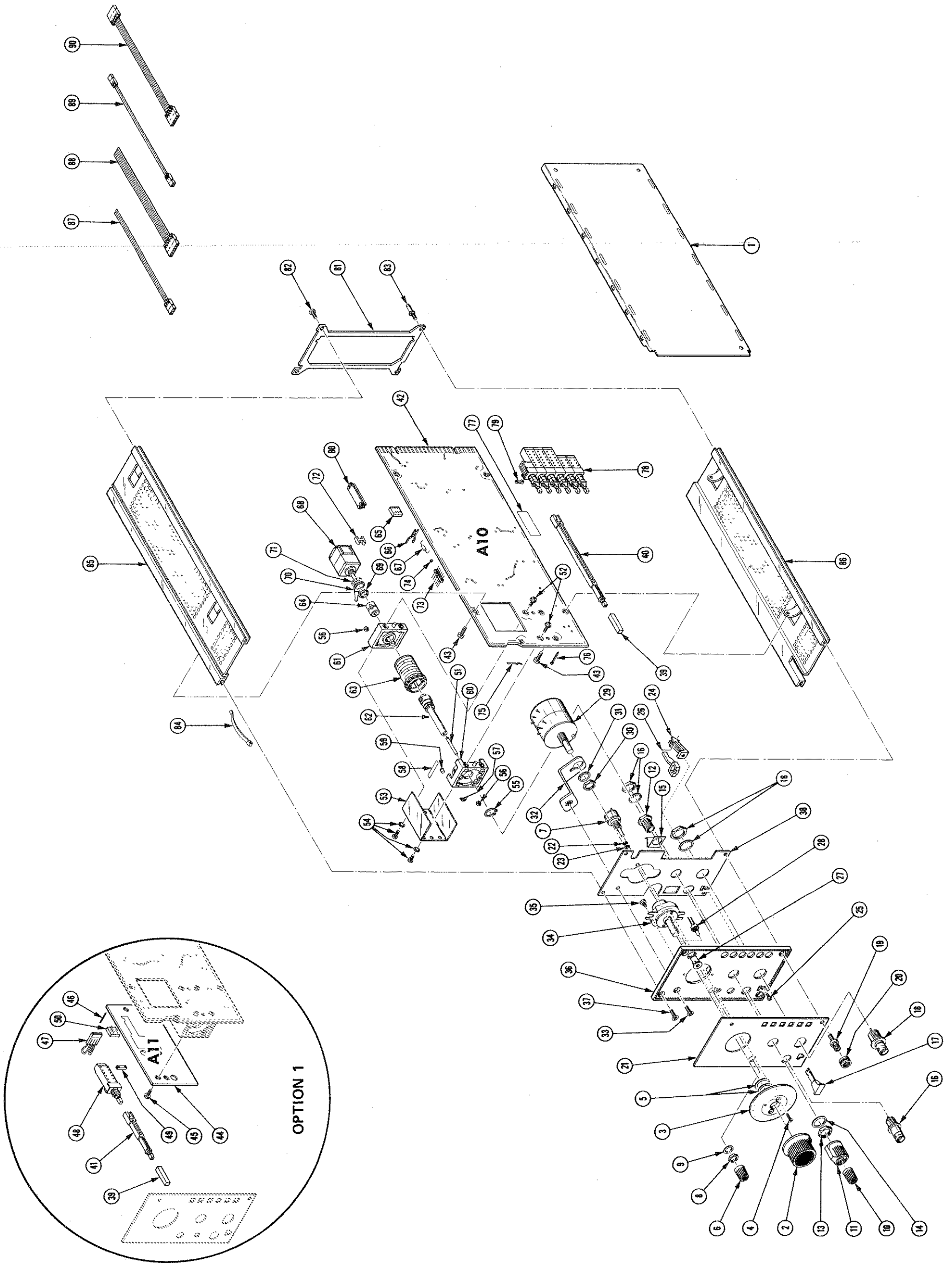

REV MAY 1985

FIG. 2 CABINET

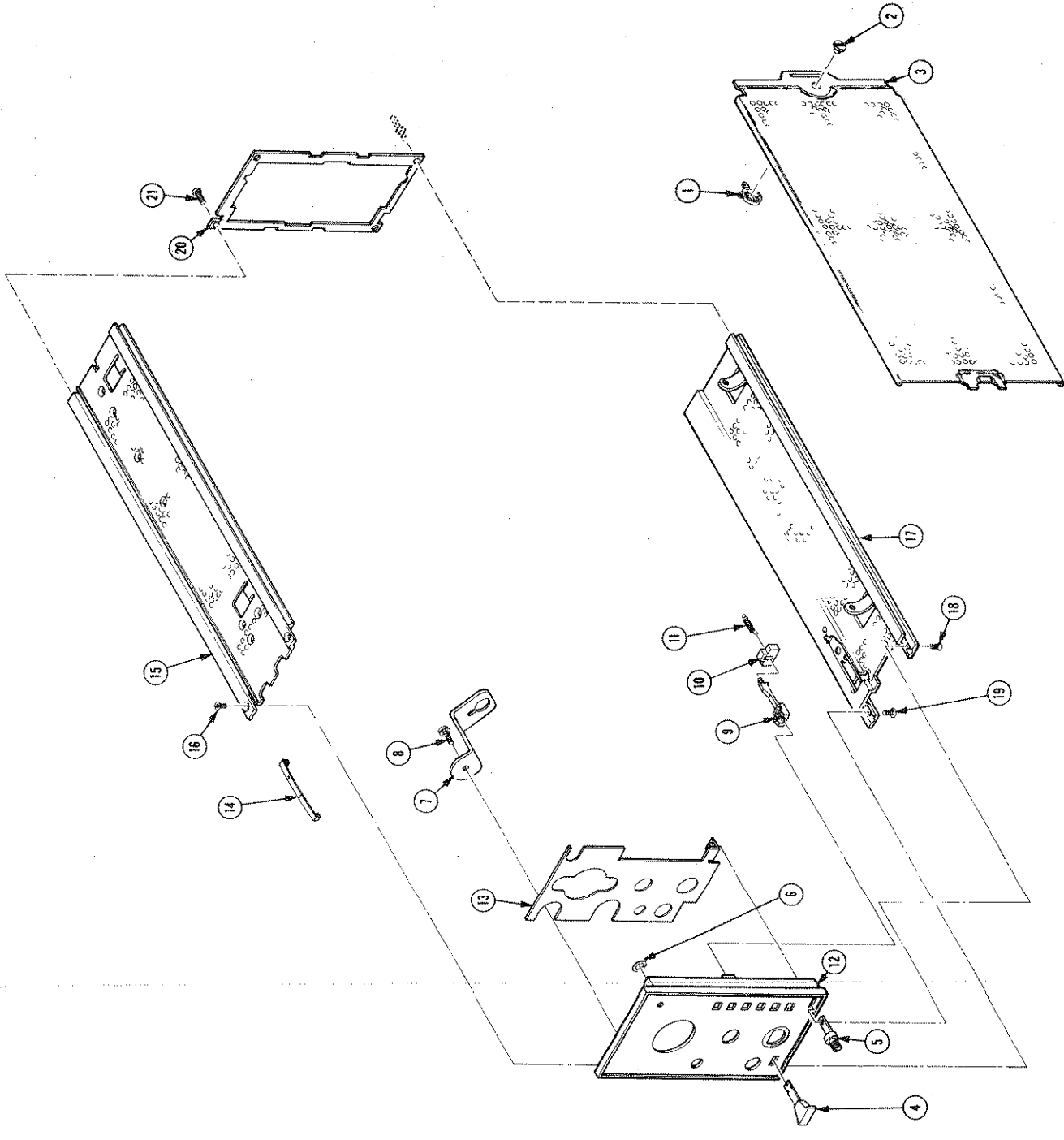

ADD MAY 1985

Fig. & Index No.	Tektronix Part No.	Serial/Assembly No.		Qty	12345	Name & Description	Mfr.	
		Effective	Dscont				Code	Mfr. Part No.
2-1	105-0932-00	B042240		2		LATCH,PANEL:SIDE	80009	105-0932-00
-2	214-3364-00	B042240		2		FASTENER,LATCH:ACETAL,SIL GRAY	80009	214-3364-00
-3	337-3039-00	B042240		2		SHIELD,ELEC:SIDE	80009	337-3039-00
-4	366-1851-01	B042240		1		KNOB,LATCH:IVORY GY,0.625 X 0.25 X 1.09	80009	366-1851-01
-5	105-0865-00	B042240		1		BAR,LATCH RLSE:	80009	105-0865-00
-6	105-0866-00	B042240		1		LATCH,RETAINING:SAFETY	80009	105-0866-00
-7	214-3143-00	B042240		1		SPRING,HLEXT:0.125 OD X 0.545 L,XLOOP	80009	214-3143-00
-8	333-1855-00	B042240		1		FRONT PNL ASSY: STANDARD ONLY)	80009	333-1855-00
	333-1950-00	B042190		1		FRONT PNL ASSY: (OPTION 01 ONLY)	80009	333-1950-00
-9	337-0010-00	B042240		1		SHIELD,CRT:	80009	337-0010-00
-10	214-3406-00	B042240		1		SPRING,FLAT:1.48 L X 0.125 M,CU BE	80009	214-3406-00
-11	426-0725-24	B042240		1		FR SECT,PLUG-IN:TOP (ATTACHING PARTS)	80009	426-0725-24
-12	211-0101-00	B042240		2		SCREW,MACHINE:4-40 X 0.25,FLH,100 DEG,STL (END ATTACHING PARTS)	TK0435	ORDER BY DESCR
-13	426-0724-25	B042240		1		FR SECT,PLUG-IN:BOTTOM (ATTACHING PARTS)	80009	426-0724-25
-14	211-0101-00	B042240		1		SCREW,MACHINE:4-40 X 0.25,FLH,100 DEG,STL	TK0435	ORDER BY DESCR
-15	211-0025-00	B042240		1		SCREW,MACHINE:4-40 X 0.375,FLH,100 DEG (END ATTACHING PARTS)	TK0435	ORDER BY DESCR
-16	386-4866-00	B042240		1		SUPPORT,FRAME:REAR,AL (ATTACHING PARTS)	80009	386-4866-00
-17	213-0793-00	B042240		2		SCREW,TPG,TF:6-32 X 0.4375,TAPTITE,FILH	83486	239-006-406043
						STANDARD ACCESSORIES		
	070-2823-00			1		MANUAL,TECH:INSTR	80009	070-2823-00

1
2
3
4
5
6
7
8
9
10
11
12
13
14
15
16
17
18
19
20
21
22
23
24
25
26
27
28
29
30
31
32
33
34
35
36
37
38
39
40
41
42
43
44
45
46
47
48
49
50
51
52
53
54
55
56
57
58
59
60
61
62
63
64
65
66
67
68
69
70
71
72
73
74
75
76
77
78
79
80
81
82
83
84
85
86
87
88
89
90
91
92
93
94
95
96
97
98
99
100

ACCESSORIES

ACCESSORIES

Fig & Index No.	Tektronix Part No.	Serial/Model No.		Qty	Name & Description					Mfr Code	Mfr Part Number
		Eff	Dscont		1	2	3	4	5		
	070-2823-00			1	MANUAL, TECH: INSTR, SG505 OSCILLATOR					80009	070-2823-00

1
2
3
4
5
6
7
8
9
10
11
12
13
14
15
16
17
18
19
20
21
22
23
24
25
26
27
28
29
30
31
32
33
34
35
36
37
38
39
40
41
42
43
44
45
46
47
48
49
50
51
52
53
54
55
56
57
58
59
60
61
62
63
64
65
66
67
68
69
70
71
72
73
74
75
76
77
78
79
80
81
82
83
84
85
86
87
88
89
90
91
92
93
94
95
96
97
98
99
100