

TECHNICAL MANUAL

OPERATOR'S, ORGANIZATIONAL, DIRECT SUPPORT, AND GENERAL SUPPORT
MAINTENANCE MANUAL

(INCLUDING REPAIR PARTS AND SPECIAL TOOLS LISTS)

FOR

DIFFERENTIAL AMPLIFIER AM-6786/U

(TEKTRONIX TYPE 7A22, VERTICAL PLUG-IN UNIT)

(NSN 6625-00-478-0597)

WARNINGS

CLEANING THE INTERIOR

Use an eye-shield when cleaning with pressurized air. Hardened dirt can be removed with a paint brush, cotton tipped swab or cloth dampened with a water and mild detergent solution. Avoid the use of chemical cleaning agents that might damage the plastic parts.

SPECIFIC COMPONENT REPLACEMENT INFORMATION

Disconnect the instrument from the power source before removing or replacing components.

The pushbutton switches are not repairable and should be replaced if defective. Components which are mounted on the circuit board associated with the pushbutton switch can be replaced using the normal replacement procedure. See the information under Light-Bulb Replacement for bulb replacement.

This manual contains copyright material reproduced by permission of Tektronix, Incorporated.

TECHNICAL Manual }

No. 11-6625-2749-14&P }

HEADQUARTERS
DEPARTMENT OF THE ARMY
Washington, DC, 10 October 1979

**OPERATOR'S, ORGANIZATIONAL, DIRECT SUPPORT, AND GENERAL SUPPORT
MAINTENANCE MANUAL**

(INCLUDING REPAIR PARTS AND SPECIAL TOOLS LISTS)

FOR

**DIFFERENTIAL AMPLIFIER AM-6786/U
(TEKTRONIX TYPE 7A22, VERTICAL PLUG-IN UNIT)
NSN 6625-00-478-0597)**

Current as of 20 March 1979

REPORTING OF ERRORS

You can improve this manual by recommending improvements using DA Form 2028-2 located in the back of the manual. Simply tear out the self-addressed form, fill it out as shown on the sample, fold it where shown, and drop it in the mail.

If there are no blank DA Forms 2028-2 in the back of your manual, use the standard DA Form 2028 (Recommended Changes to Publications and Blank Forms) and forward to the Commander, US Army Communications and Electronics Materiel Readiness Command, ATTN: DRSEL-ME -MQ, Fort Monmouth, NJ 07703.

In either case, a reply will be furnished direct to you.

This manual is an authentication of the manufacturer's commercial literature which, through usage, has been found to cover the data required to operate and maintain this equipment. Since the manual was not prepared in accordance with military specifications, the format has not been structured to consider levels of maintenance.

TABLE OF CONTENTS

SECTION	Page	Page
SECTION 0		
Introduction	0-1	'age
SECTION 1 SPECIFICATION		
Introduction	1-1	Input Gate Current 2-4
Electrical Characteristics	1-1	Voltage Measurement 2-4
Deflection Factor	1-1	Signal Input Connectors 2-4
Gain	1-1	High Input Impedance 2-5
Differential Dynamic Range	1-1	Display Polarity 2-5
DC Offset	1-1	Deflection Factor 2-5
Frequency Response	1-1	Bandwidth Selection 2-5
Bandwidth limit	1-1	Voltage Comparison Measurements 2-10
Recovery Time	1-1	Differential Operation 2-10
Common-Mode Signal Range	1-1	DC Offset Operation 2-11
Common-mode Rejection Ratio	1-1	Input Overdrive Indicator 2-12
Maximum input Voltage	1-3	Readout 2-12
Input Rand C	1-3	Trace Identify 2-13
Maximum Input Gate Current	1-3	
Variable Balance	1-3	
Step Attenuator DC Balance	1-3	
Displayed Noise		
(Tangentially Measured)	1-3	
DC Drift	1-3	
Isolation between + and — Inputs	1-3	
Environmental Characteristics	1-3	
Altitude	1-3	
Transportation	1-3	
Physical Characteristics	1-3	
Finish	1-3	
Dimensions	1-3	
Weight	1-3	
SECTION 2 OPERATING INSTRUCTIONS		
Introduction	2-1	
Front Panel Controls and Connectors	2-1	
Operating Instructions	2-2	
First Time Operation	2-2	
General Operating Information	2-4	
Trace Drift	2-4	
		SECTION 3 CIRCUIT DESCRIPTION
		Introduction 3-1
		Block Diagram Description 3-1
		Input Coupling 3-1
		Input Attenuators 3-1
		Preamp 3-1
		L F -3 dB Point 3-1
		Output Amplifier 3-2
		H F -3 dB Point 3-2
		General Information 3-2
		Feedback Amplifiers 3-2
		Differential Configuration 3-3
		Detailed Circuit Description 3-3
		Input Coupling 3-3
		Input Attenuators 3-4
		Gate Current Compensation 3-4
		Input Amplifier 3-4
		X15 Preamp 3-4
		DC Balance 3-4
		Floating Power Supply 3-5
		Common-Mode Rejection 3-5
		Cross Neutralization 3-6

TABLE OF CONTENTS

	Page		Page
Input Overdrive Protection	3-7	Detailed Troubleshooting	4-4
DC Off set	3-7	General	4-4
Offset Generator	3-7	Test Equipment Recommended	4-4
Input Overdrive Indicator	3-8	DC Balance Check	4-4
L F -3 dB Point Selector	3-9	Troubleshooting by Direct	
Output Amplifier	3-9	Replacement	4-5
Gain Switching Amplifier	3-9	Component Checks	4-6
Variable Output Stage	3-11	Transistors	4-6
Signal Output Amplifier	3-11	Diodes	4-6
Trigger Output Amplifier	3-11	Resistors	4-6
Indicator Oscilloscope Readout	3-11	Capacitors	4-7
Probe Sensing	3-11		
Trace Identify	3-11		

SECTION 4 MAINTENANCE

Introduction	4-1
Preventive Maintenance	4-1
General	4-1
Cleaning Front Panel	4-1
Cleaning Interior	4-1
Visual Inspection	4-1
Transistor Checks	4-1
Calibration	4-1
Corrective Maintenance	4-1
General	4-1
Obtaining Replacement Parts	4-2
Special Parts	4-2
Soldering Techniques	4-2
Component Replacement Information	4-3
Troubleshooting	4-3
Introduction	4-3
Indicator Oscilloscope	4-4
Operating Procedure and	
Control Settings	4-4
Trouble Symptoms	4-4
Visual Inspection	4-4
Calibration Check	4-4

SECTION 5 PERFORMANCE CHECK/ CALIBRATION PROCEDURE

Introduction	5-1
Test Equipment Required	5-1
General	5-1
Short Form Procedure	5-2
Performance Check/Calibration	
Procedure	5-3
General	5-3
Preliminary	5-3
Check or Adjust	5-4
AC Atten Balance	5-4
Variable Balance	5-4
Coarse DC Balance.	5-4
+ Gate Current Zero	5-5
- Gate Current Zero	5-5
GAIN	5-5
VARIABLE Control Ratio	5-5
VOLTS/DIV Gain Switching	5-5
Isolation between + and -	
Inputs	5-7
Total DC Offset Range	5-7
C241 + Cross Neutralization	5-7
C141 - Cross Neutralization	5-8
CI 15 XI +Input Atten Time	
Constant	5-8

TABLE OF CONTENTS

	Page	SECTION 6 ELECTRICAL PARTS LIST
C215 x1 - Input Atten Time		Abbreviations and Symbols
Constant	5-8	Parts Ordering Information
Input Atten Accuracy	5-9	Index of Electrical Parts List
Input Atten Differential Balance	5-9	Electrical Parts List
+ Input Atten Series		
Compensation	5-10	
- Input Atten Compensation	5-10	SECTION 7 DIAGRAMS AND ME-
-input Atten Shunt		CHANICAL PARTS ILLUSTRATIONS
Compensation	5-11	Diagrams
H F -3dB Point	5-12	Mechanical Parts Illustrations
L F -3dB Point	5-12	
CMRR	5-13	SECTION 8 MECHANICAL PARTS
Input Overdrive Indicator	5-13	LIST
Differential Dynamic Range	5-14	Mechanical Parts list Information
Overall Noise Level		Index of Mechanical Parts Illustrations
(Measured Tangentially)	5-15	Mechanical Parts List
Overdrive Recovery Time	5-15	
SECTION 10 CALIBRATION TEST		SECTION 9 PART NUMBER-NATIONAL STOCK
EQUIPMENT REPLACEMENT		NUMBER CROSS REFERENCE INDEX.
APPENDIX A. REFERENCES		1-1
B. COMPONENTS OF END ITEM LIST (Not Applicable)		
C. ADDITIONAL AUTHORIZATION LIST (Not Applicable)		
D. MAINTENANCE ALLOCATION		
Section I. General		D-1
II. Maintenance Allocation Chart for Differential Amplifier		
AM-6786/U		D-4
III. Tool and Test Equipment Requirements for Differential		
Amplifier AM-6786/U		D-5
APPENDIX E. EXPENDABLE SUPPLIES AND MATERIALS LIST (Not Applicable)		

LIST OF ILLUSTRATIONS

Figure		Page
1-1	Type 7A22 Differential Amplifier.	(A)
1-2	CMRR vs Frequency for signal not exceeding Common Mode Signal Range	1-2
2-1	Signals applied to the + INPUT Connector Produce an Upright Display, while signals applied to the - INPUT are inverted	2-1
2-2	Location of AC ATTEN BAL Control	2-3
2-3	Location of wire strap between input line and internal gate	2-5
2-4A	7A22 CMRR at 10 uV/Div to 10 mV/Div. Inputs DC Coupled. Worst-case degradation due to source resistance	2-6
2-4B	7A22 Bandwidth and VOLTS/DIV Error as functions of Source Resistance	2-7
2-5	7A22 FREQUENCY RESPONSE as a function of LF -3 dB POINT SETTING (HF -3 dB POINT at 1 MHz)	2-8
2-6	7A22 FREQUENCY RESPONSE as a function of HF -3 dB POINT settings (LF -3 dB POINT of DC).	2-9
2-7	Improving signal-to-noise ratio by setting bandwidth	2-10
2-8	Waveforms showing differential rejection of a common-mode signal	2-11
2-9	Connecting a differential amplifier across a circuit	2-12
3-1	Generalized feedback system showing the relation between input and output	3-2
3-2	Feedback amplifier (Single-ended version).	3-2
3-3	Feedback amplifier (Differential configuration).	3-3
3-4	Gate Current Compensation	3-4
3-5	Common-mode Rejection using floating power supply	3-5
3-6	Input cross neutralization	3-6
3-7	Effects of high impedance to ground in the - INPUT	3-7

Figure		Page
3-8	(A) Overdrive Protection System showing current paths. (B, C) Sequence of events leading to excessive overdrive	3-8
3-9	Offset system showing (A) Conditions with zero offset, (B) 0.25V DC offset	3-9
3-10	Functional arrangement of the offset generator	3-10
3-11	Partial Low Frequency -3 dB Point selector for + Input amplifier	3-11
4-1	Removing or replacing component on circuit board	4-2
4-2	Transistor junction-voltage measurements	4-6
4-3	Transistor base pin and socket arrangement	4-7
4-4	Diode polarity and color code	4-8
4-5	Color code for resistors and ceramic capacitors	4-8
4-6	Plain circuit board (components)	4-10
4-7	Main circuit board (wire color code)	4-11
4-8	Bandwidth circuit board (components and wire color code) .	4-12
5-1	Left side of the 7A22 showing adjustment locations	5-4
5-2	Equipment required for steps 6 through 19	5-6
5-3	Typical waveform showing (A) Cross neutralization properly adjusted, (B) incorrectly adjusted	5-7
5-4	Typical waveform showing (A) Correct adjustment of Input Attenuator Time Constant. (B) and (C) incorrect adjustment	5-8
5-5	Typical display obtained when Input Attenuators are adjusted for optimum differential balance	5-9
5-6	Typical display obtained with - Input attenuator adjusted for optimum Common-Mode signal rejection. (A) C208C adjusted properly (B) C209C adjusted properly	5-10
5-7	Equipment required for steps 20 through 24	5-11
5-8	Right side of Type 7A22 showing location of adjustments . .	5-12

Figure		Page
5-9	Equipment required for step 25	5-14
5-10	Typical display showing (A) two noise bands and (B) merging noise bands	5-15
5-11	Equipment required for step 26	5-16
5-12	Typical waveform showing overdrive recovery time	5-16

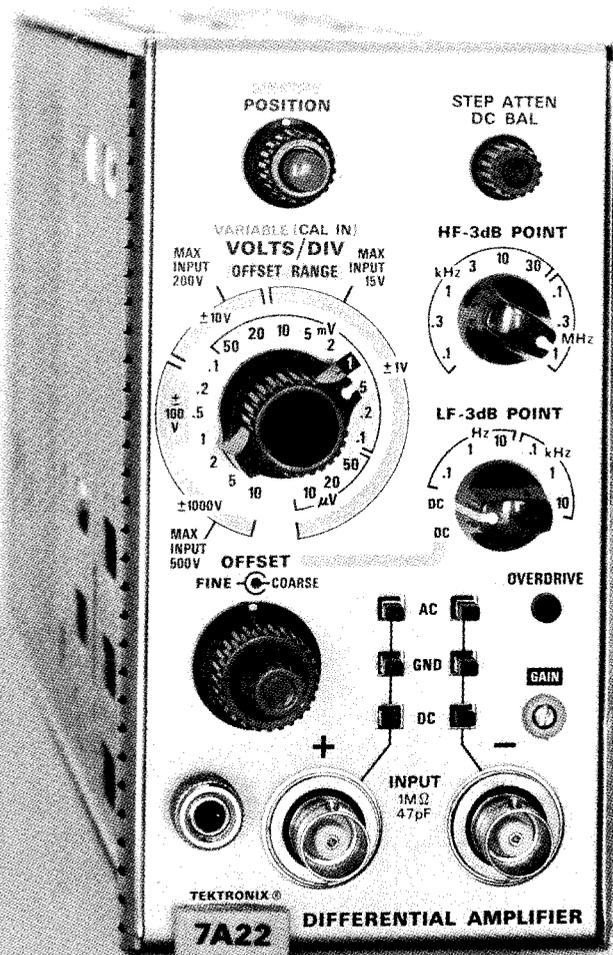

Fig. 1-1. Type 7A22 Differential Amplifier.

SECTION 0

INTRODUCTION

0-1. SCOPE

This manual describes Vertical Plug-In Unit, Differential Amplifier AM-6786/U and provides instructions for operation and maintenance. Throughout this manual, the AM-6786/U is referred to as Tektronix Type 7A22 Differential Amplifier. The maintenance allocation chart appears in appendix D. Also, included is a repair parts list.

0-2. INDEXES OF PUBLICATIONS

a. DA Pam 310-4. Refer to the latest issue of DA Pam 310-4 to determine whether there are new editions, changes, or additional publications pertaining to the equipment.

b. DA Pam 310-7. Refer to DA Pam 310-7 to determine whether there are modification work orders (MWO'S) pertaining to the equipment.

0-3. FORMS AND RECORDS

Reports of Maintenance and Unsatisfactory Equipment. Maintenance forms, records, and reports which are to be used by maintenance personnel at all maintenance levels are listed in and prescribed by TM 38-750.

b. Report of Packaging and Handling Deficiencies. Fill out and forward DD Form 6 (Packaging Improvement Report) as prescribed in AR 700-58/NAVSUPINST 4030.29/AFR 71-13/MCO P4030.29A and DLAR 4145.8.

Discrepancy in Shipment Report (DISREP) (SF 361). Fill out and forward Discrepancy in Shipment Report (DISREP) (SF 361) as prescribed in AR 55-38/NAVSUPINST 4610.33B/AFR 75-18/MCO P4610.19C and DLAR 4500.15.

0-4. REPORTING EQUIPMENT IMPROVEMENT RECOMMENDATIONS (EIR)

EIR's will be prepared using DA Form 2407, Maintenance Request. Instructions for preparing EIR's are provided in TM 38-750, The Army Maintenance Management System. EIR's should be mailed direct to Commander, US Army Communications and Electronics Materiel Readiness Command; ATTN: DRSEL-ME-MQ, Fort Monmouth, NJ 07703. A reply will be furnished directly to you.

0-5. ADMINISTRATIVE STORAGE

Administrative storage of equipment issued to and used by Army activities shall be in accordance with TM 750-244-2.

0-6. DESTRUCTION OF ARMY ELECTRONICS MATERIEL

Destruction of Army electronics materiel to prevent enemy use shall be in accordance with TM 750-244-2.

SECTION 1 SPECIFICATION

Introduction

The Type 7A22 Vertical Plug-in is a DC coupled differential amplifier with excellent common-mode rejection characteristics and high gain for low level applications.

The DC Offset capability of the Type 7A22 allows the display of the very small low-frequency signals containing a large DC component, at deflection factors not possible with AC coupling. The vertical deflection factor range of the Type 7A22 is from 10 μ V to 10 V. The high and low frequency -3 dB points can be selected at the front panel, to set the bandwidth of the instrument. Thus, for low frequency applications the signal-to-noise ratio can be improved by restricting the bandwidth of the Type 7A22. The bandwidth selection and excellent drift-with-time characteristics provide measurement capabilities in the biomedical, transducer, and other areas which require stable, low deflection factor, low noise measurements.

The Type 7A22 is designed for use in Tektronix 7000 Series oscilloscopes.

The electrical characteristics described in this section are valid over the stated environmental range for instruments calibrated at an ambient temperature of +20°C to +30°C and after a 5 minute warmup unless otherwise noted.

ELECTRICAL CHARACTERISTICS

Characteristic	Performance Requirements
Deflection Factor (VOLTS/DIV) Gain Ratio Accuracy	Within 2% with GAIN adjusted at 1 mV/div
VAR (CAL IN) Range	Continuously variable; extends deflection factor to at least 25 V/div
GAIN	Permits adjustment of deflection factor at 1 mV/DIV for all mainframes
Differential Signal Range (DC OFFSET not used)	
10 μ V/Div to 10 mV/Div	At least ± 1 V
20 mV/Div to 0.1 V/Div	At least ± 10 V
0.2 V/Div to 1 V/Div	At least ± 100 V
2 V/Div to 10 V/Div	At least ± 1000 V

DC OFFSET COARSE Range from Electrical Zero	
10 μ V/Div to 10 mV/Div	At least +1 V to -1 V
20 mV to 0.1 V/Div	At least +10 V to -10 V
0.2 V to 1 V/Div	At least +100 V to -100 V
2 V to 10 V/Div	At least +1000 V to -1000 V
Frequency Response (8 div Reference)	
Overall Frequency Response DC (Direct) Coupled Input	DC to within 10% of 1 MHz at -3dB
AC (Capacitive) Coupled Input Lower Bandwidth Frequency	2 Hz or less
Bandwidth Limit Accuracy	
HF -3 dB POINT 100 Hz to 1 MHz	9 steps in a 1-3 sequence
Accuracy	Within 10% of selected frequency
LF -3 dB POINT 0.1 Hz to 10 kHz	6 steps in a 1-10 sequence
Accuracy	Within 12% of selected frequency
Recovery Time	10 μ s or less to recover to within 0.5% of zero level after the removal of a + or - test input applied for 1 s. Test signal not to exceed Differential Signal Range. Specified aberration (0.5%) based on test signal amplitude
Common Mode Signal	
10 μ V/Div to 10 mV/Div	At least +10 V and -10 V
20 mV/Div to 0.1 V/Div	At least +100 V and -100 V
0.2 V/Div to 10 V/Div	At least +500 V and -500 V
Common-Mode Rejection Ratio	
DC (Direct) Coupled	See Verification Points on graph, Fig. 1-2.
AC (Capacitive) Coupled	See Verification Points on graph, Fig. 1-2.

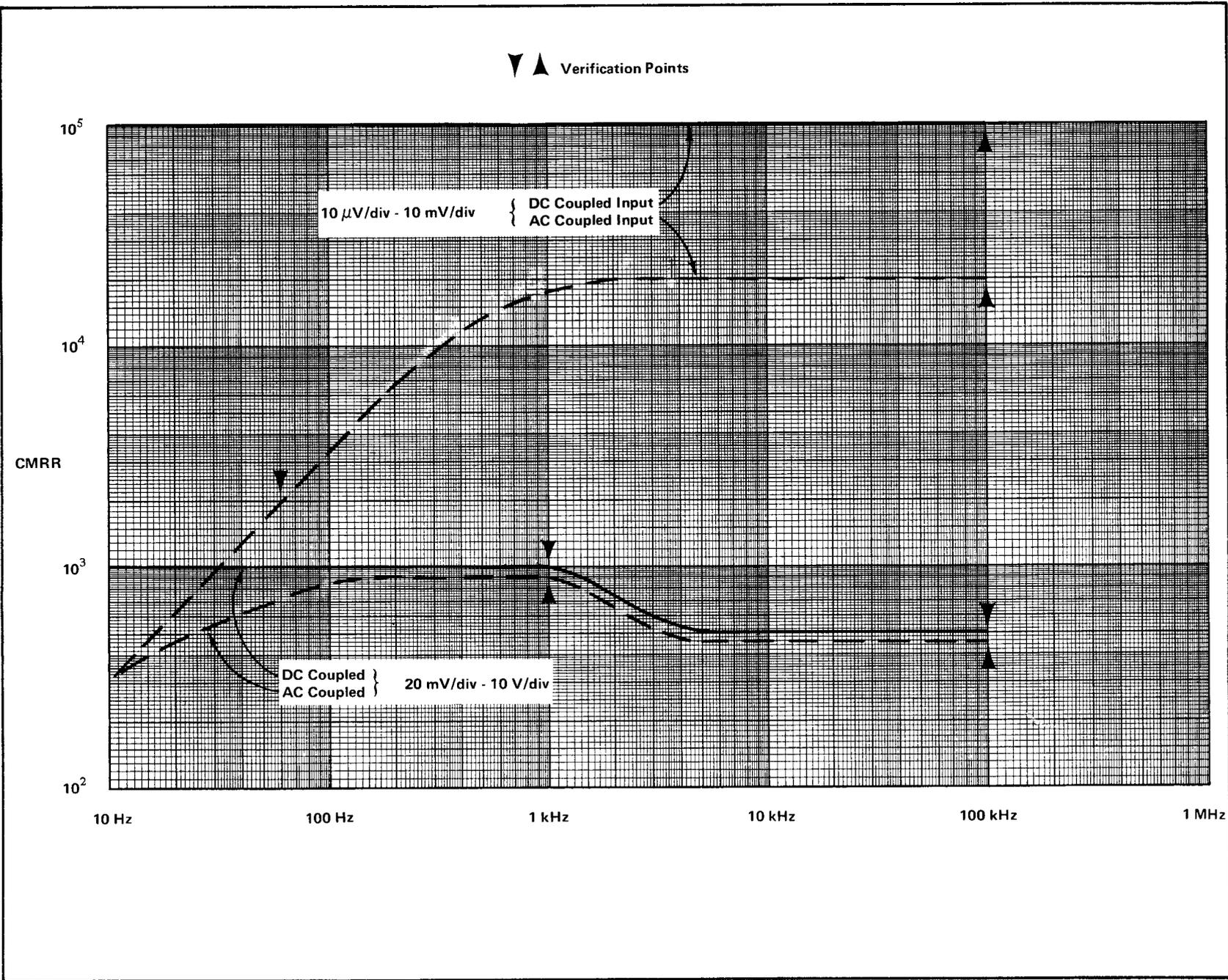

Fig. 1-2. CMRR vs. Frequency for signals not exceeding Common Mode Signal Range.

ELECTRICAL CHARACTERISTICS (cont)

Characteristic	Performance Requirements
Maximum Input Voltage (each input) DC (Direct) Coupled, DC + Peak AC, AC Component 1 MHz or less	
10 μ V/Div to 10 mV/Div	± 15 V
20 mV/Div to 0.1 V/Div	± 200 V
.2 V/Div to 10 V/ Div	± 500 V
AC (Capacitive) Coupled Input DC Voltage	± 500 V, each input
AC (Capacitive) Coupled Input DC Rejection	At least $4 \times 10^5 : 1$
Input R and C Resistance	1 M Ω \pm 1%
Capacitance	Approximatel 47.0 pF
R & C Product	Within ± 1 % between all de- flection factors
Maximum Input Gate Current	+25°C +50°C
10 μ V/Div to 10 mV/ Div	± 20 pA ± 100 pA each input ± 40 pA ± 200 pA Differentially
20 mV/Div to 10 V Div	± 10 pA ± 20 pA
Display Shift at 10 μ V /Div (AC Coupled)	± 4 div ± 20 div
Variable Balance	0.2 div or less shift with VARIABLE control turned from fully cw to fully ccw position
Displayed Noise (Tan- getially Measured)	16 μ V or 0.1 Div (whichever is greater), 1 MHz HF -3 dB POINT, source resistance 25 Ω or less

DC Drift Drift with Time (Ambi- ent Temperature and Line Voltage Constant) Short Term	5 μ V (P-P) or 0.1 div (whichever is greater) in any minute after 1 hour warmup
Long Term	10 μ V (P-P) or 0.1 div (whichever is greater) in any hour after 1 hour warmup
Drift with Ambient Temperature (Line Voltage Constant)	50 μ V/°C or less
Isolation between + and - Inputs (+ INPUT to an Open - INPUT, - INPUT to an Open + INPUT)	At least 200:1, DC to 1 MHz

ENVIRONMENTAL

PLUG-IN TESTED OUT OF INDICATOR OSCILLOSCOPE

ITEM	CHARACTERISTIC
Altitude Non-operating	To 50,000 feet and -55° C
Transportation	Qualified under National Safe Transit Committee test procedure 1A, Category II

PHYSICAL

ITEM	CHARACTERISTIC
Finish	Front panel is anodized aluminum
Dimensions	$\approx 14\frac{5}{8}$ inch L \times $2\frac{5}{8}$ inch W \times 4 $\frac{7}{8}$ inch H
Weight	$\approx 2\frac{5}{8}$ lbs

SECTION 2

OPERATING INSTRUCTIONS

Introduction

This section opens with a brief functional description of the front-panel controls, input overdrive lamp, and input connectors. Following the front-panel description is a familiarization procedure and finally a general discussion of the operation of the Type 7A22.

CONTROLS AND CONNECTORS

INPUT OVERDRIVE	Input overdrive indicator lamp turns on to indicate excessive differential drive to the input amplifier stage. Lights when the differential dynamic range between input connectors is exceeded.
VOLTS/DIV	Volts per displayed division. Nineteen position switch used to select the calibrated deflection factors.
VARIABLE (CAL IN)	Two-position switch activated by the VARIABLE knob to select calibrated or uncalibrated deflection factors. At the IN position, the VARIABLE control is inoperative and the deflection factor is calibrated. When pressed and released, the knob moves outward to activate the VARIABLE control for uncalibrated deflection factors. The uncalibrated position provides continuously variable uncalibrated attenuation between the calibrated deflection factors and extends the deflection factor to at least 25 VOLTS/DIV.
GAIN	Screwdriver adjust control to set the CRT display scale factor to agree with the VOLTS/DIV switch indication. Adjusted for proper deflection with the VOLTS/DIV switch set to the 1 mV position.
POSITION	The control that vertically positions the trace or display.
IDENTIFY	Momentary contact, push-button switch, concentric with POSITION. Will cause the trace, representing the output of the Type 7A22, to move a small amount when pressed. Aids in identifying the Type 7A22 trace when multiple traces are displayed.
HIGH FREQUENCY -3 dB POINT	Nine position switch to select the approximate high frequency -3 dB point. The switch positions are: 100 Hz, 300 Hz, 1 kHz, 3 kHz, 10 kHz, 30 kHz, 100 kHz, 300 kHz, and 1 MHz.

LOW FREQUENCY -3 dB POINT

Eight position switch to select DC coupling or the approximate low frequency -3 dB points. The switch positions are: DC OFFSET, DC, .1 Hz, 1 Hz, 10 Hz, 100 Hz, 1 kHz, and 10 kHz.

+ INPUT

Signal input connector. Positive input produces deflection upward (see Fig. 2-1).

- INPUT

Signal input connector. Positive input produces deflection downward (see Fig. 2-1).

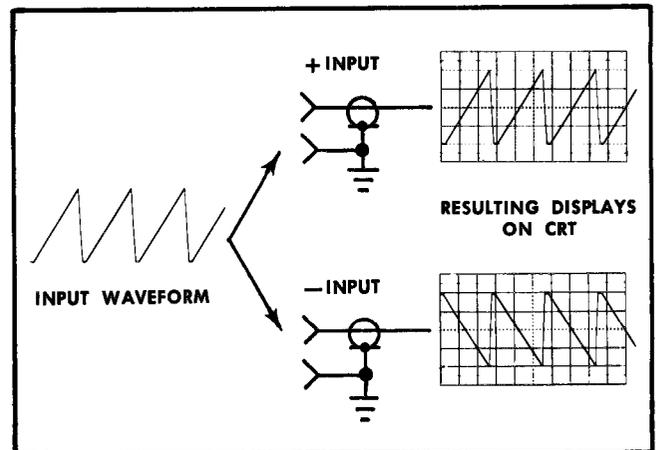

Fig. 2-1. Signals applied to the + INPUT connector produces an upright display, while signals applied to the - INPUT are inverted.

+ AC-GND-DC

A miniature illuminated push-button type switch. The buttons are interlocked so that only one button may be depressed at one time. When the 'AC' button is depressed the signal is coupled through 0.1 μ F to the Input Amplifier and only the varying component of the input signal is amplified.

When the 'DC' button is depressed the signal is coupled directly to the Input Amplifier and the entire input signal, both AC and DC, is amplified. When the 'GND' button (or none of the buttons) is depressed, the signal is coupled through 0.1 μ F and through 1 $M\Omega$ to ground. The Amplifier Input is grounded in this condition.

Each push-button is illuminated from behind when the button is depressed.

— AC-GND-DC Same function as the + AC-GND-DC switch but applied to the — INPUT.

IMPORTANT

The following two controls are operative only when the LOW FREQUENCY —3 dB POINT switch is set to DC or DC OFFSET.

STEP ATTEN DC BAL (DC MODE ONLY) Front panel control for DC balancing the amplifier input stage. With no signals applied to the input connectors, the control is adjusted for no trace shift as the VOLTS/DIV switch is moved from the 10 mV position to the 10 μ V position.

DC OFFSET (DC OFFSET mode only) Coarse and fine controls to provide internal offset bias while maintaining the differential capability. Available range of the offset bias depends upon the settings of the VOLTS/DIV switch, and is indicated by shaded gray bands (OFFSET RANGE) around the VOLTS/DIV switch.

RELEASE LATCH Gray rectangular knob near the bottom left of the front panel. Pull out to remove Plug-In from Plug-In compartment.

OPERATING INSTRUCTIONS

First-Time Operation

Steps 1 through 5 in the following procedure are intended to help place the trace on the screen quickly and prepare the unit for immediate use. Steps 6 through 8 are used to check the GAIN adjustment. These steps along with those remaining are intended to demonstrate some of the basic functions of the Type 7A22.

1. Insert the unit into the oscilloscope plug-in compartment.

2. Set the Type 7A22 front-panel controls as follows:

VOLTS/DIV	1 mV
VARIABLE	IN (CAL)
POSITION	Midrange
HIGH FREQUENCY	1 MHz
—3 dB POINT	
LOW FREQ —3 dB POINT	DC
AC-GND-DC (+ INPUT)	GND
AC-GND-DC (— INPUT)	GND
STEP ATTEN DC BAL	Midrange

3. Turn the oscilloscope Intensity control fully counter-clockwise and turn the oscilloscope Power ON. Preset the time-base and triggering controls for a .5 ms sweep rate and automatic triggering.

4. Wait about five minutes for the Type 7A22 and the oscilloscope to warm up.

NOTE

About five minutes is sufficient time for warmup when using the Type 7A22 for short-term DC measurements. For long-term DC measurements using the lower deflection factors, allow at least one hour.

5. Adjust the Intensity control for normal viewing of the trace. The trace should appear near the graticule center.

6. Using the POSITION control, position the trace 2 divisions below graticule center.

CAUTION

If the maximum input voltage rating in the 10 μ V to 10 mV range of the VOLTS/DIV switch is exceeded, the inputs are diode-clamped to fixed voltages of approximately + 16.5 volts and/or —16.5 volts and damage to the signal source is possible. If the signal source can supply more than 1/16 A of current, the input protective fuse (s) will open. An open input fuse is indicated by the lighting of the INPUT OVERDRIVE indicator with the input coupling switches set to GND.

7. Apply a 4 mV peak-to-peak calibrator signal through a coaxial cable to the + INPUT connector on the Type 7A22.

8. For DC coupled, single-ended operation, set the + INPUT AC-GND-DC coupling switch to DC. The display should be square waves 4 divisions in amplitude with the bottom of the display at the reference established in step 6.

9. For AC coupled, single-ended operation, reposition the display with the Type 7A22 POSITION control to place the bottom of the display at the graticule center line.

10. Set the + INPUT AC-GND-DC coupling switch to AC and note that the display shifts downward about 2 divisions to its average level.

11. Disconnect the coaxial cable from the + INPUT connector. Connect a dual input connector to the + INPUT and — INPUT connectors. Connect the coaxial cable from the Calibrator to the dual input connector.

12. For AC coupled differential operation, set the —INPUT AC-GND-DC coupling switch to AC. The calibrator signal is now coupled to both inputs as a common-mode signal. A straight line display should be observed, since the common-mode is being rejected.

Operational Adjustments

NOTE

Most of the following checks and adjustments may be made after a 5 minute warmup; however due to the DC drift of the amplifier during subsequent warmup, the STEP ATTEN DC BAL should be re-adjusted for each check or adjustment, and a warmup of at least one hour should be allowed before a final adjustment of the STEP ATTEN DC BAL is attempted. Insure that the oscilloscope used in conjunction with the Type 7A22 is correctly calibrated (refer to the oscilloscope manual) and that the calibrated output voltage is correct.

1. AC ATTEN BAL (**internal adjustment**). When the LOW FREQ -3 dB POINT switch is used to limit the low frequency response of the Type 7A22, the unit employs AC stabilization. This means that when the switch is set to any position except DC or DC OFFSET, the STEP ATTEN DC BAL and DC OFFSET controls become inoperative. VOLTS/DIV balance is then controlled with the AC ATTEN BAL, an internal adjustment (see Fig. 2-2).

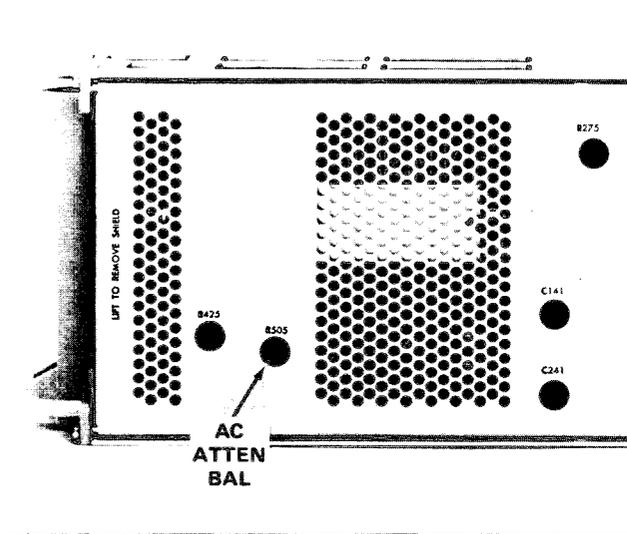

Fig. 2-2. Location of AC ATTEN BAL control.

When transferring the Type 7A22 from one oscilloscope to another, it may be necessary to perform a minor re-adjustment of this control, due to normal power supply variations between oscilloscopes.

NOTE

An unbalance of up to 30 μ V is normal and cannot be reduced by adjusting the AC ATTEN BAL control.

a. With the Type 7A22 inserted into the oscilloscope, remove the left side panel of the oscilloscope and set the Type 7A22 controls as follows:

- VOLTS/DIV 1 mV
- AC-GND-DC (+ INPUT) GND
- AC-GND-DC (-INPUT) GND
- LOW FREQ -3 dB POINT 10 Hz
- HIGH FREQ -3 dB POINT 100 Hz

b. Using the POSITION control, position the trace to graticule center.

c. Set the VOLTS/DIV switch to 20 μ V.

d. Adjust the AC ATTEN BAL control, R505, to position the trace to within 1.5 divisions of graticule center. (See note in step 1).

INTERACTION: If this adjustment is made out of sequence, steps 2 and 3 must also be performed.

2. VAR BAL R425. (Internal adjustment).

a. Set the Type 7A22 controls as in step 1-a.

b. Position the trace to graticule center with the POSITION control.

c. With the VAR (CAL IN) in the out position, rotate the VARIABLE control from stop to stop. Check for no movement of trace.

d. Adjust R425 for no movement of trace as the VARIABLE control is rotated from stop to stop. (See Fig. 2-2 for location of adjustment.)

3. STEP ATTEN DC BAL. With zero input voltage and the LF -3 dB POINT selector at DC, if the STEP ATTEN DC BAL is not properly adjusted the CRT trace will shift vertically as the VOLTS/DIV switch is rotated throughout its range. The shift is more noticeable at the most sensitive positions.

a. Set the Type 7A22 front-panel controls as follows:

- VOLTS/DIV 10 mV
- VARIABLE (CAL IN) CAL
- POSITION Midrange
- HIGH FREQ -3 dB POINT 1 MHz
- LOW FREQ -3 dB POINT DC
- AC-GND-DC (+ INPUT) GND
- AC-GND-DC (-INPUT) GND
- STEP ATTEN DC BAL Midrange

b. Using the Type 7A22 POSITION control, position the CRT trace to the center of the graticule.

c. Set the VOLTS/DIV switch to 10 μ V.

d. Return the trace to graticule center by adjusting the STEP ATTEN DC BAL control.

NOTE

The adjustment of the STEP ATTEN DC BAL control should be checked periodically during the use of the instrument. If the Type 7A22 is used DC coupled or in significantly varying ambient temperatures in the 10 μ V/DIV to .1 mV/DIV ranges, the STEP ATTEN DC BAL should be checked quite frequently. It is good practice to check this control and readjust, if necessary, before any critical measurement is made under the above conditions.

4. GAIN

a. Perform steps 1 through 8 in the First-Time Operation Procedure.

b. Adjust the GAIN control for exactly 4 divisions of display.

NOTE

Accuracy of this adjustment is dependent upon the voltage accuracy of the calibration source.

GENERAL OPERATING INFORMATION

Trace Drift

The environment in which the Type 7A22 is operated and the inherent characteristics of the Type 7A22 influence trace drift. Therefore, to determine trace drift for a specific environment refer to the Specification Section. In environment in which the ambient temperature does not vary much (such as an air-conditioned building) the trace drift generally will not exceed 10 μV in one hour.

Input Gate Current

When using the .1 mV/DIV to 10 μV /DIV ranges for measurement with an AC coupled input, for DC measurements where the source impedance is high (in excess of 1 M Ω) the input gate current should be checked and allowed for, or adjusted to zero. This is particularly desired at high temperatures (above 40° C). Steps 7 and 8 in the Performance Check/Calibration Procedure describe the check and adjust procedures for setting the gate current to zero.

Voltage Measurement

To obtain accurate DC measurements at maximum sensitivity, it is necessary to ground the input and DC balance the amplifier just before making the measurement. This is accomplished by adjusting the STEP ATTEN DC BAL as described under operational adjustment number 3.

When measuring DC voltages, use the largest deflection factor (10 V/DIV) when first connecting the Type 7A22 to an unknown voltage source. Then, if the deflection is too small to make the measurement, switch to a lower deflection factor. If the input stage is overdriven, a large amount of current might flow into the input. See CAUTION after item 6 of First Time Operation.

Where only the AC component of a signal having both AC and DC components is to be measured, use the AC-GND-DC switches to take advantage of the pre-charging circuit incorporated in the unit. The pre-charging circuit permits the coupling capacitor to charge to the DC source voltage when the AC-GND-DC switch is set to GND. Procedure for using this circuit is as follows:

- a. Before connecting the Type 7A22 to a signal containing a DC component, set the AC-GND-DC input coupling switch to GND. Then connect the input to the circuit under test.
- b. Allow about one second for the coupling capacitor to charge.
- b. Set the input coupling switch to AC. The display will remain on the screen and the AC component can be measured in the usual manner.
- d. On completion of the measurement, set the AC-GND-DC switch to GND and short the input connector to ground.

The above procedure should be followed whenever another signal with a different DC level is connected.

CAUTION

If the Type 7A22 is connected to a large DC voltage source without using the pre-charge provision, the peak charging current (into 0.1 μF

capacitor) will be limited only by the signal source, and this source may be damaged or destroyed.

When a large DC voltage has been applied to the Type 7A22 with the input AC coupled, the input coupling capacitor acquires a charge due to dielectric polarization and acts as a low voltage, high impedance voltage source with a very slowly decaying output voltage. This can offset subsequent AC coupled measurements at other DC voltages and drive the trace off-screen. A period of at least 10 minutes, with input set to GND, should be allowed to assure reasonable recovery from polarization, and a longer period may be necessary for critical measurements. If the input connectors are shorted to ground the depolarization process will require less time.

Signal Input Connectors

When connecting signals to the +INPUT and -INPUT connectors on the Type 7A22, consider the method of coupling that will be used. Ordinary unshielded test leads can sometimes be used to connect the Type 7A22 to a signal source, particularly when a high level, low-frequency signal is monitored at a low impedance point. However when any of these factors are missing, it becomes increasingly important to use shielded signal cables. In all cases, the signal-transporting leads should be kept as short as practical.

When making single-ended input measurements, be sure to establish a common ground between the device under test and the Type 7A22. The shield of a coaxial cable is normally used for this purpose.

In some cases differential measurements require no common ground¹, and therefore are less susceptible to interference by ground loop currents. Some problems with stray magnetic coupling into the signal transporting leads can also be minimized by using a differential rather than single-ended measurement. These considerations are discussed later in this section under Differential Operation.

It is always important to consider the signal-source loading and resulting change in the source operating characteristics due to the signal-transporting leads and the input circuit of the Type 7A22. The circuit at the input connectors can normally be represented by a 1 megohm resistance to ground paralleled by 47 pF. A few feet of shielded cable may increase the parallel capacitance to 100 pF or more. In many cases, the effects of these resistive and capacitive loads may be too great and it may be desirable to minimize them through the use of an attenuator probe.

Attenuator probes not only decrease the resistive and capacitive loading of a signal source, but also extend the measurement range of the Type 7A22 to include substantially higher voltages. Passive attenuator probes having attenuation factors of 10 \times , 100 \times , and 1000 \times , as well as other special-purpose types are available through your Tektronix Field Engineer or Field Office.

Some measurement situations require a high-resistance input to the Type 7A22 with very little source loading or sig-

¹The DC plus peak AC voltages on the test points with respect to the chassis potential of the Type 7A22 should be limited to the levels listed in Section 1 under Maximum Common-mode Input Voltage characteristics. Higher levels will degrade the common-mode rejection ratio and exceed the input voltage rating of the unit.

nal attenuation. In such a situation a passive attenuator probe cannot be used. However, this problem may be solved by using an active probe or the high input impedance provision of the Type 7A22.

High Input Impedance

The high input impedance provision applies only to DC coupled signals which permit the use of 10 mV through 10 μ V positions of the VOLTS/DIV switch, (DC coupled). Since no input attenuator is used at these switch positions, the internal gate return resistor alone establishes the 1 megohm input resistance.

The high input impedance is obtained by unsoldering the wire strap (see Fig. 2-3) between the input line and the internal gate return resistance. The signal source must then provide a DC path for the FET gate current.

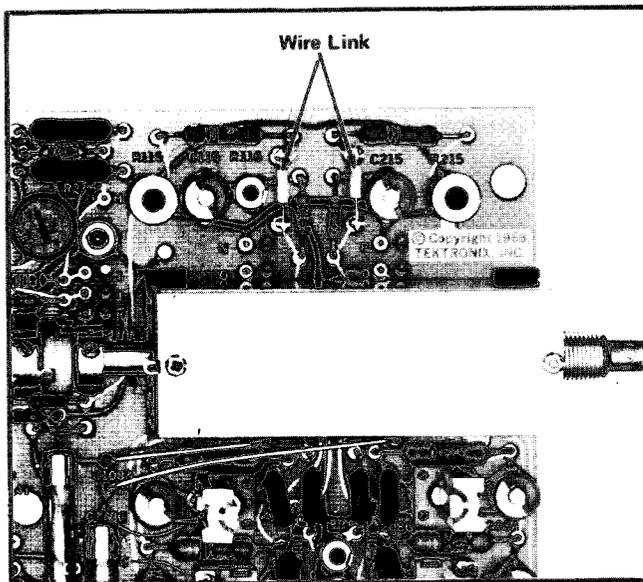

Fig. 2-3. Location of wire strap between input line and internal gate return resistor.

The uncompensated gate current is typically less than 100 picoamperes, but may be several times higher depending upon the operating temperature. The signal-source impedance is therefore an important factor since gate current will produce a DC offset. For example, a 100 picoampere gate current through 10 megohms produces a 1 mV offset; this may result in a significant error where small voltages are of concern.

NOTE

When the wire straps are removed, R111 and R211 are disconnected. The deflection factor in the 20 mV/DIV to 10V/DIV range will be incorrect.

The high-frequency response will also depend upon the signal-source impedance, since various shunt capacitances between the source and the 7A22 input as well as the 47 pF input capacitance, must charge and discharge through that impedance (see Fig. 2-4).

Display Polarity

Single-ended signals can be applied to either the +INPUT or -INPUT connector. If the +INPUT is chosen, positive-going changes in the input signal will cause the trace to be deflected upward, and negative-going changes will cause the trace to be deflected downward. If the -INPUT is chosen, input-to-display polarity relationship will be reversed as shown previously in Fig. 2-1.

Deflection Factor

The amount of trace deflection produced by a signal is determined by the signal amplitude, the attenuation factor of the probe, the setting of the VOLTS/DIV switch and the setting of the VARIABLE control. The calibrated deflection factors indicated by the VOLTS/DIV switch apply only when the VARIABLE control is pushed "in" to the CAL IN position.

The range of the VARIABLE control is at least 2.5:1. It provides uncalibrated deflection factors covering the full range between the fixed settings of the VOLTS/DIV switch. The control can be set to extend the deflection factor to at least 25 volts/div.

Noise

To reduce noise and obtain a more usable display when the VOLTS/DIV switch is operated in the 10 μ V, 20 μ V, and 50 μ V positions or when the signal source is noisy, it is suggested that the HIGH FREQ -3 dB POINT selector be set to use the lowest bandwidth setting which does not appreciably distort the desired features of the signal under observation. Refer to Fig. 2-6 for the high frequency rolloff for each setting of the HIGH FREQ -3 dB POINT selector.

Bandwidth Selection

In addition to the differential rejection of unwanted signals, many times an undesired signal can be attenuated by varying the bandwidth of the unit. The LOW FREQ -3 dB POINT and HIGH FREQ -3 dB POINT selectors on the front panel of the 7A22 control the low-frequency and high-frequency -3 dB points of the amplifier. The LOW FREQ -3 dB POINT selector provides low-frequency response to DC or to approximate -3 dB points at .1 Hz, 1 Hz, 10 Hz, 100 Hz, 1 kHz, and 10 kHz. Refer to Fig. 2-5. The HIGH FREQ -3 dB POINT selector controls the high-frequency rolloff from 1 MHz to 100 Hz in a 1-3-10 sequence. Beyond the -3 dB points the frequency response falls off at a 6 dB per octave rate. Refer to Fig. 2-6.

Varying the bandwidth of the Type 7A22 is useful, for example, when displaying a low-frequency signal. By reducing the high-frequency response the noise can, in many cases, be considerably reduced without distorting the desired signal (see Fig. 2-7). Likewise, undesired line-frequency signals can be filtered out by restricting the low-frequency response of the unit. When using the LOW FREQ -3 dB POINT and HIGH FREQ -3 dB POINT selectors, care must be taken not to distort non-sinusoidal waveforms by overly restricting the amplifier bandwidth.

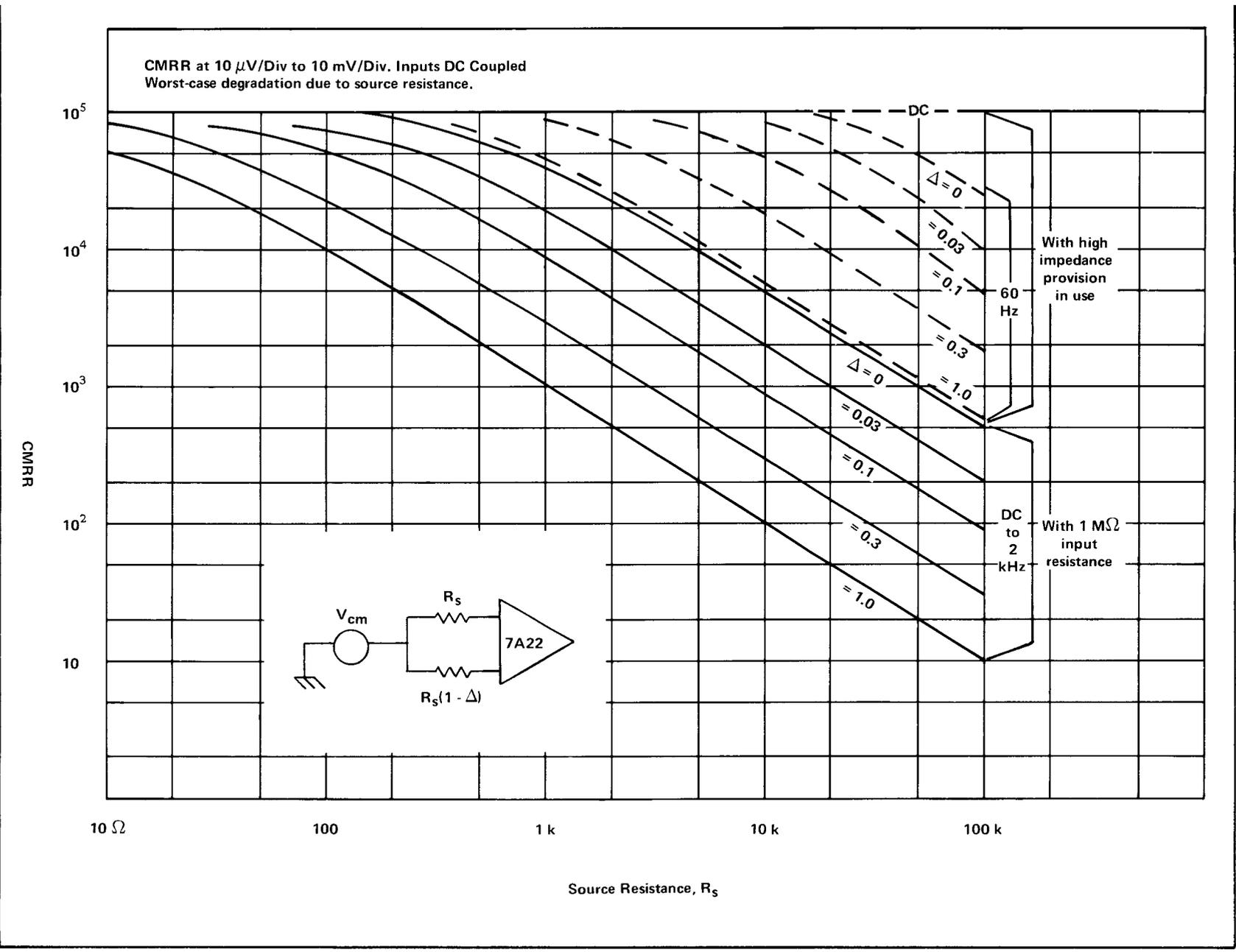
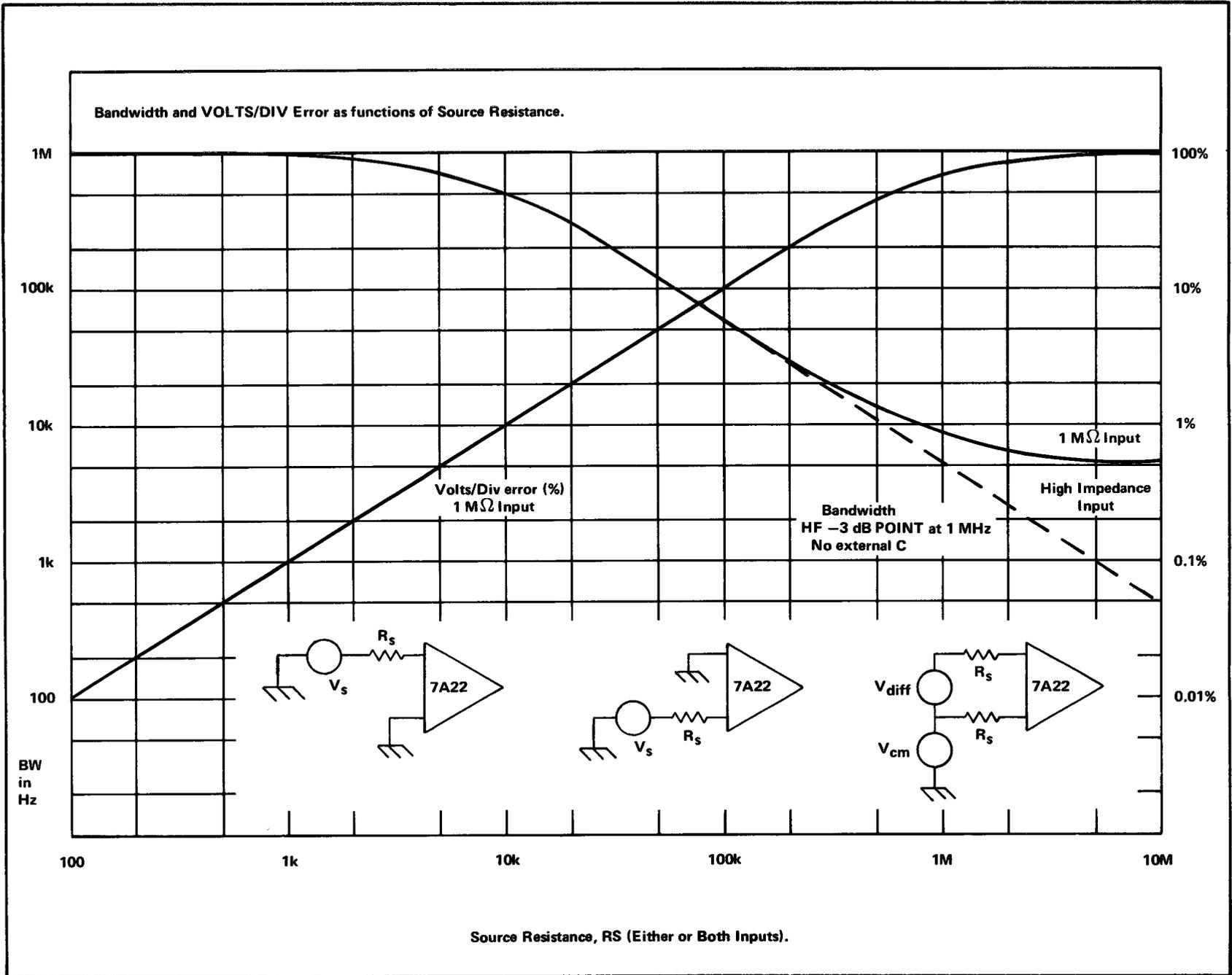

Fig. 2-4A. 7A22 CMRR at 10 μ V/Div to 10 mV/Div. Inputs DC Coupled. Worst-case degradation due to source resistance.

Fig. 2-4B. 7A22 Bandwidth and VOLTS/DIV Error as functions of Source Resistance.



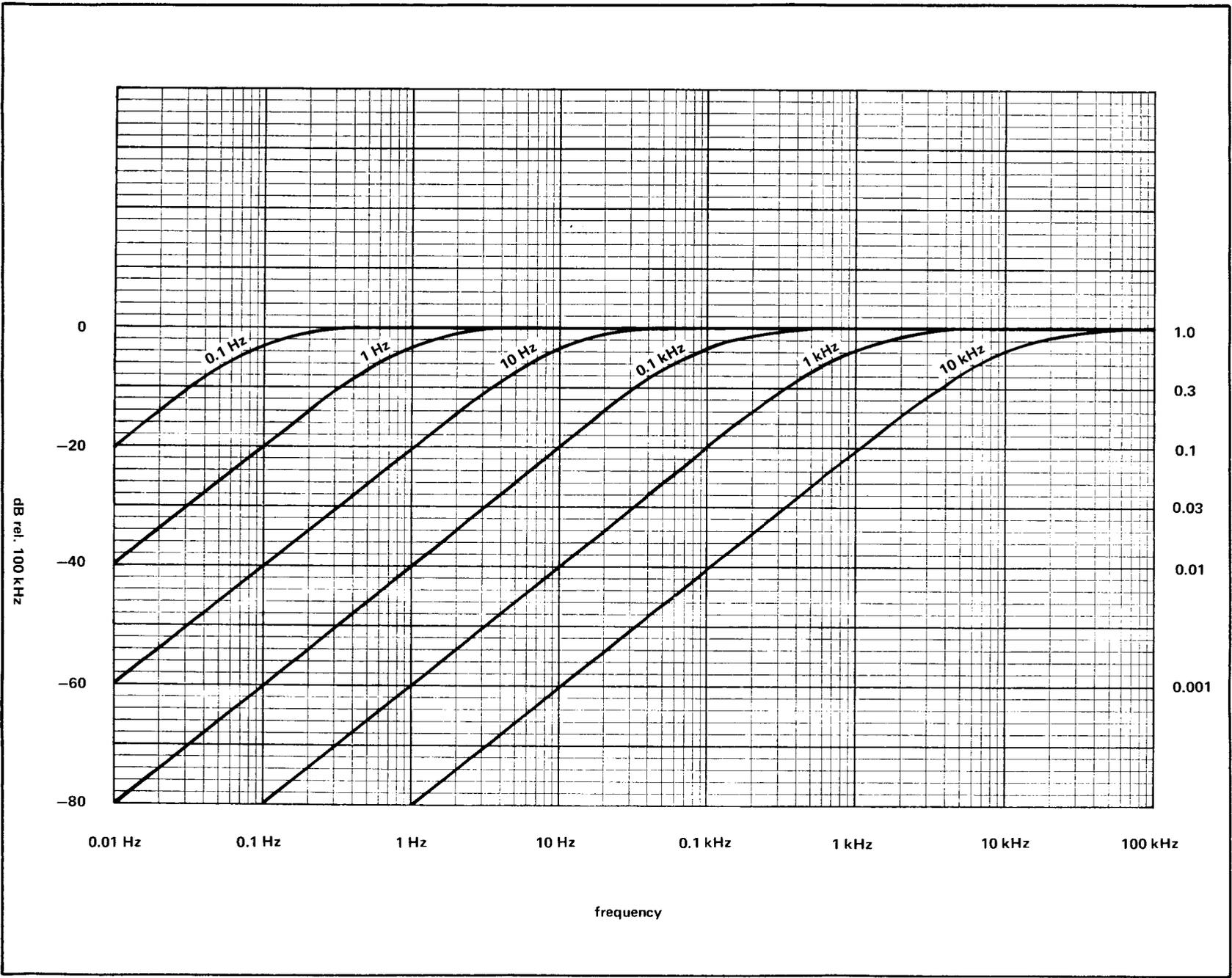

Fig. 2-5. 7A22 FREQUENCY RESPONSE as a function of LF -3 dB POINT SETTING (HF -3 dB POINT at 1 MHz)

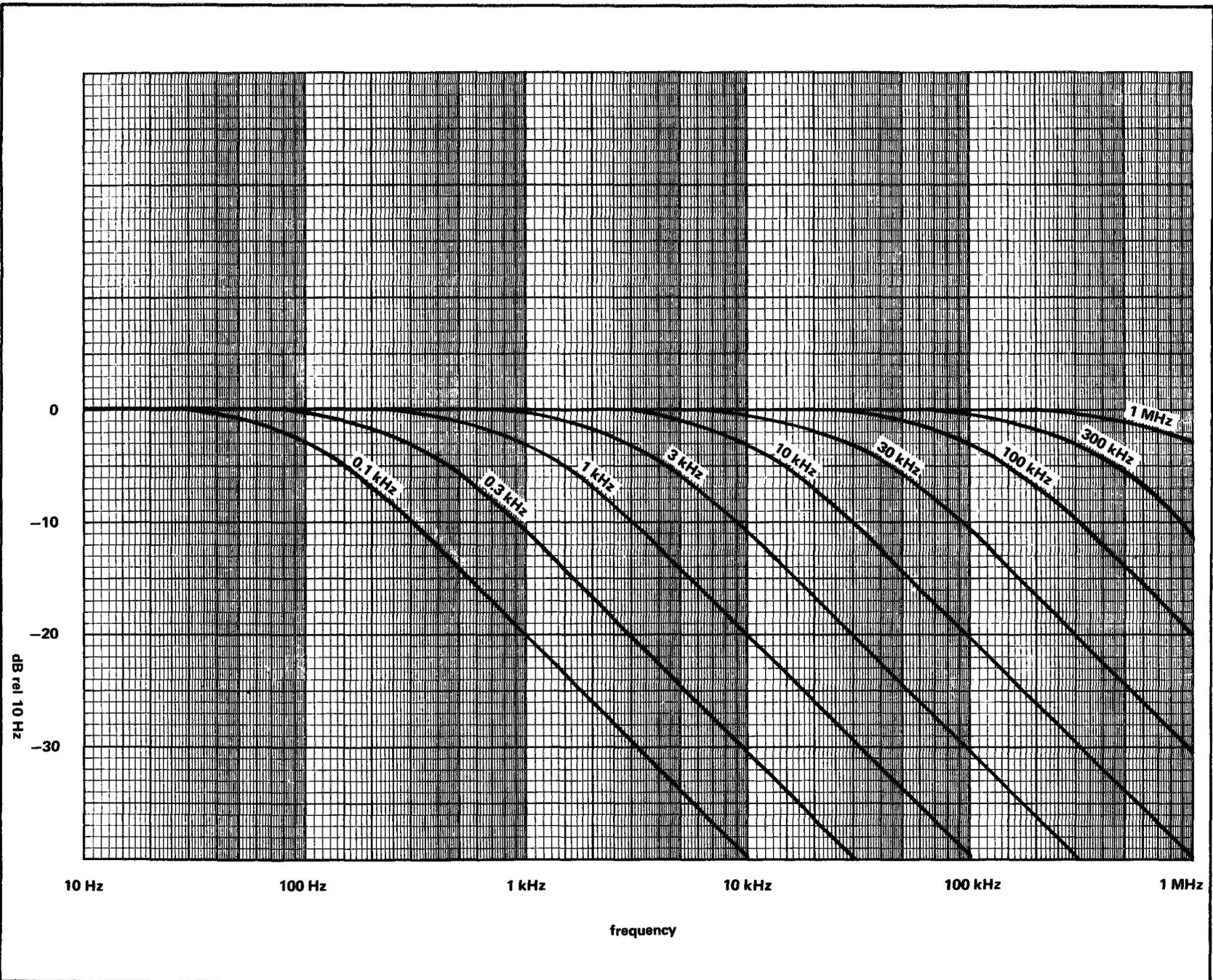

Fig. 2-6. 7A22 FREQUENCY RESPONSE as a function of HF - 3 DB POINT settings (LF — 3 DB POINT of DC).

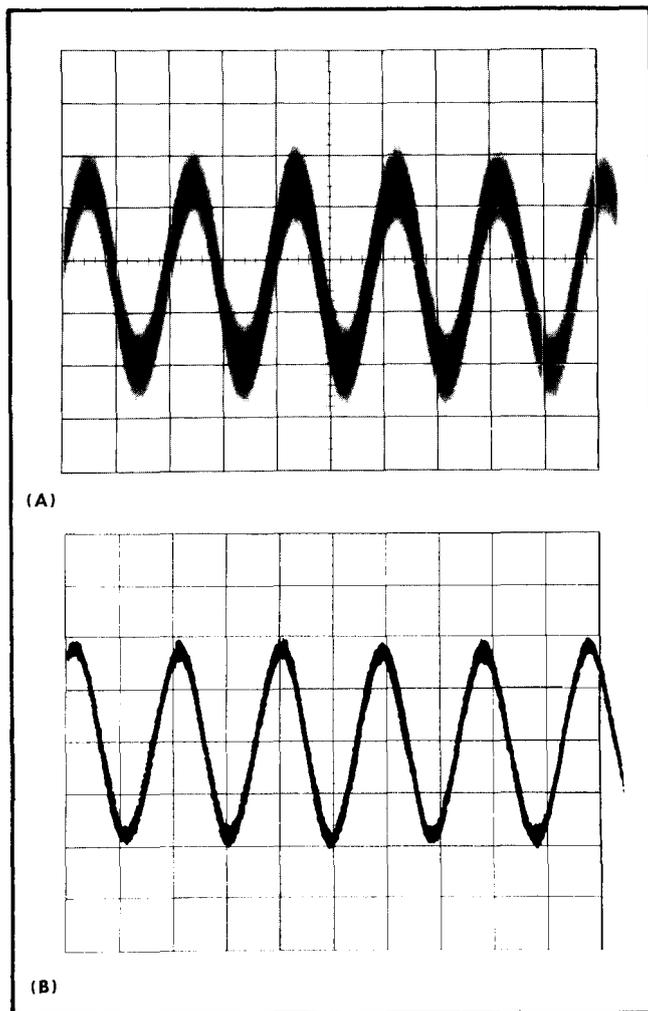

Fig. 2-7. Improving signal-to-noise ratio by setting bandwidth. (A) Lower —3 dB FREQUENCY selector to DC, UPPER —3 dB FREQUENCY 1 MHz. (B) Lower —3 dB FREQUENCY selector to DC, UPPER —3 dB FREQUENCY, 10 kHz.

Voltage Comparison Measurements

Some applications require a set of deflection factors other than the fixed values provided by the VOLTS/DIV switch. One such application is comparison of signal amplitudes by ratio rather than by absolute voltage.

To accomplish this, apply a reference signal to either input of the Type 7A22. Set the VOLTS/DIV switch and VARIABLE control throughout the subsequent comparisons. The settings of the VOLTS/DIV switch can be changed, however, to accommodate large ratios. In doing so, regard the numbers which designate the switch position as ratio factors rather than voltages.

Differential Operation

Differential voltage measurements are made by applying the signals to the +INPUT and -INPUT connectors. Then, both AC-GND-DC switches should be set to the same positions: AC or DC, depending on the method of signal

The Type 7A22 differential input provision may be used to eliminate interfering signals such as AC line-frequency hum. Single-ended measurements often yield unsatisfactory information because of interference resulting from ground-loop currents between the oscilloscope and the device under test. In other cases, it may be desirable to eliminate a DC voltage by means other than the use of a DC-blocking capacitor which would limit low-frequency response. These limitations of single-ended measurements are virtually eliminated in differential measurements.

A differential measurement is made by connecting each of the two inputs to selected points in the test circuit. The input to the amplifier will then be the difference in voltage of the two selected points (see Fig. 2-9).

The ability of the Type 7A22 to reject common-mode signals is indicated by the common-mode rejection ratio (CMRR). This ratio is at least 100,000:1 at the input connectors for the lower deflection factors (10 μ V to 10 mV per division) when signals between DC and 100 kHz are DC-coupled to the inputs. To show the significance of this characteristic, assume that a single-ended input signal consists of an unwanted 60 Hz signal at 1 volt P-P plus a desired signal at 1 mV P-P. If an attempt is made to display the desired signal with the VOLTS/DIV switch set to .2 mV, the 60 Hz signal would produce a deflection equivalent to 5000 div, and thus little useful information about the 1 mV signal could be obtained.

If, however, the same 1 mV signal is monitored differentially so that the 60 Hz signal is common-mode at the inputs, no greater than one part in one hundred thousand of the common-mode signal will appear in the display. Thus, the desired signal produces a display amplitude of 5 div with only .05 div of interference due to the common-mode signal.

There are a number of factors which can degrade common-mode rejection. The principal requirement for maximum rejection is for the common-mode signal to arrive at the input FET gates in precisely the same form. A difference of only 0.01 % in the attenuation factors of the input attenuators may reduce the rejection ratio to 10,000:1. Likewise, any difference in source impedance at the two points in the source under test will degrade the rejection ratio. Attenuator probes which do not have an adjustable resistance may reduce the rejection ratio to 100:1 or less.

Outside influences such as electrostatic and magnetic fields can also degrade the performance, particularly when low level signals are involved. Electrostatic interference can be minimized by using shielded signal transporting leads of the same type to the two inputs, and by twisting the leads together throughout most of their length.

Care should be taken to minimize the movement of the signal transporting leads, as any movement of a lead, in the presence of a magnetic field, will tend to induce a signal into that lead. Where an interfering magnetic field cannot be avoided, the pickup loop formed by the two leads should be minimized by taping or twisting them together throughout most of their length. Low-frequency measurements can be similarly protected by using a shielded cable which contains a twisted pair of conductors.

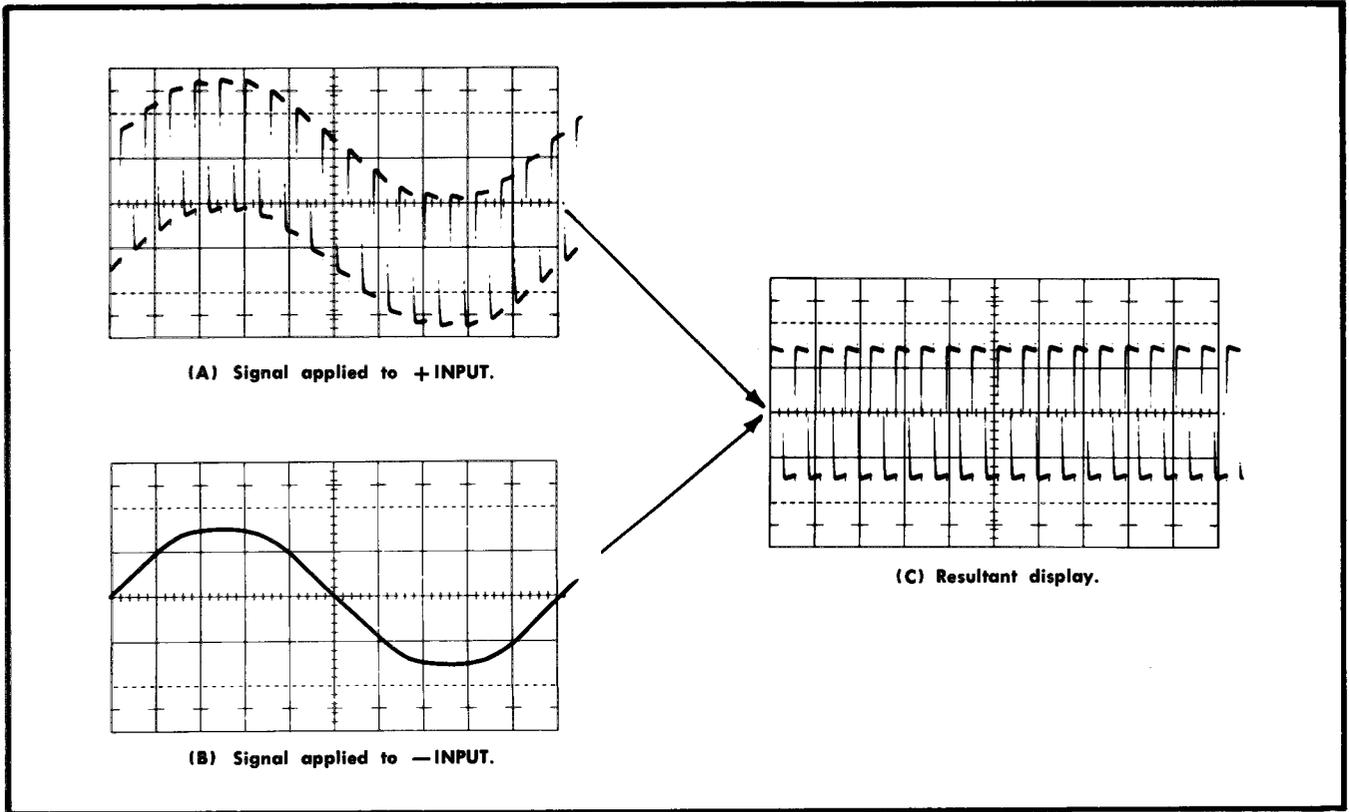

Fig. 2-8. Waveforms showing differential rejection of a common-mode signal. Resultant waveform (c) shows the difference between the two signals.

DC Offset Operation

By using the DC OFFSET controls, it is possible to use the Type 7A22 differentially in a slide-back mode, to observe small signal whose DC potential difference may be considerable. The offset is continuously adjustable from +1 V to -1 V when the VOLTS/DIV switch is in the 10 μ V to 10mV positions. In the 20mV, 50mV and .1 V positions of the VOLTS/DIV switch, the 1 V offset is effectively multiplied by the input attenuator to a range of ± 10 V. Table 2-1 summarizes the effective DC offset voltages internally available for all the VOLTS/DIV switch positions. The table also lists the input attenuator that is switched into the amplifier circuit for the various VOLTS/DIV switch positions.

TABLE 2-1

VOLTS/DIV setting	OFFSET RANGE	ATTENUATOR in
10 μ V to 10 mV	± 1 V	1X
20 mV to 0.1 V	± 10 V	10X
0.2 V to 1 V	± 100 V	100X
2 V to 10 V	± 1000 V ²	1000X

²CAUTION— ± 500 volts is the maximum allowable signal voltage of each input.

Using the DC OFFSET functions:

Set the Type 7A22 controls as follows:

VOLTS/DIV	10 V
VARIABLE (CAL IN)	CAL
POSITION	Midrange
AC-GND-DC (+ and - INPUT)	GND
HF -3 dB POINT	1 MHz
LF -3 dB POINT	DC
STEP ATTEN DC BAL	Adjusted for DC balance

1. Position the trace to graticule center (or some other convenient reference line) using the POSITION control.
2. Connect a coaxial cable from the signal source to the +INPUT.
3. Set the + INPUT AC-G ND-DC switch to DC and measure the DC level to be offset.
4. Set the VOLTS/DIV to the largest deflection factor in an offset range which will encompass the DC level measured in step 3. See Table 2-1 and front panel color bands.
5. Set the LF -3 dB POINT selector to DC OFFSET,

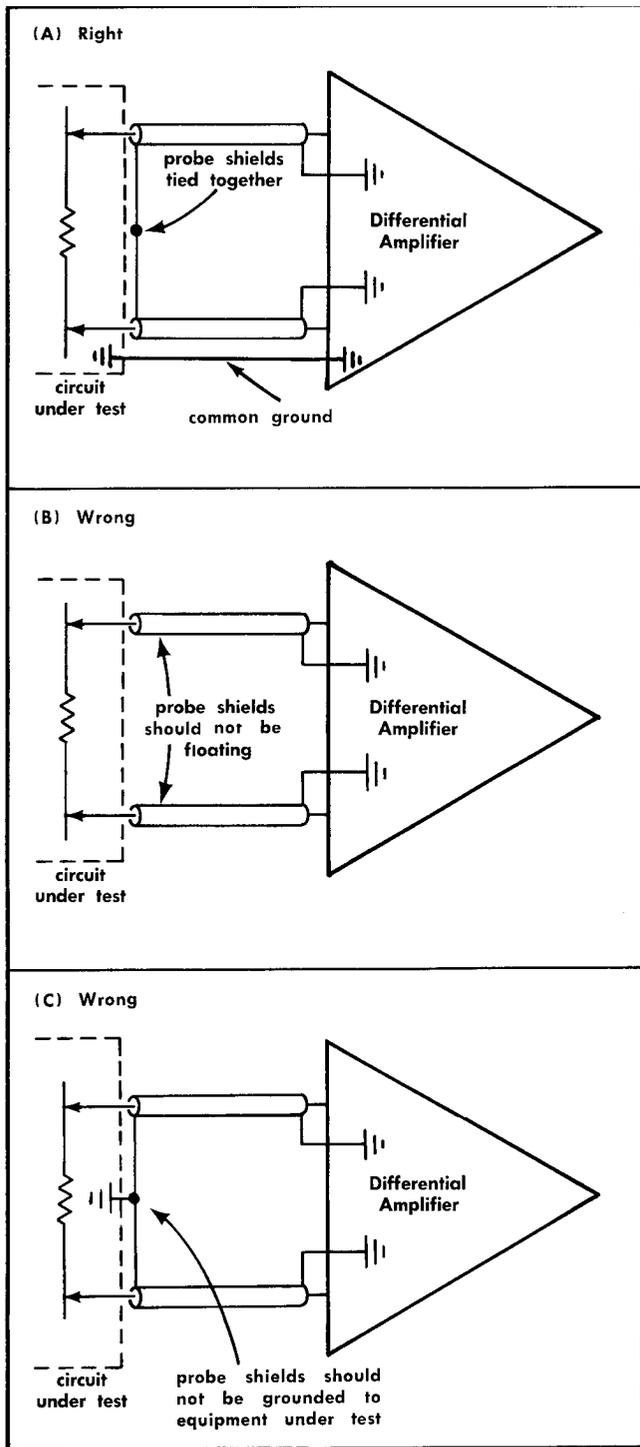

Fig. 2-9. Connecting a differential amplifier across a circuit.

6. Use the COARSE and FINE controls to move the portion of the signal to be observed to the reference line established in step 1.

7. If a different size display is needed, the deflection factor may be changed in the same offset range.

NOTE

If switching into another offset range, the OFFSET controls will need to be readjusted. If switching into a smaller offset range, check that the available range is sufficient to encompass the DC level present (see steps 3 and 4 above).

Input Overdrive Indicator

The INPUT OVERDRIVE indicator turns on when the signal to the input FETs approaches the differential dynamic range of the amplifier. The 7A22 should not be left connected to a circuit if this light is on, as this may mean that a damaging voltage is present.

The INPUT OVERDRIVE indicator serves another important function. If the amplifier is direct-coupled at the input, a DC differential signal could overdrive the input stage and cause a reduction in gain. The small voltages to be measured will not be distorted, but will be reduced in amplitude. As a result, amplitude measurements made under such conditions will not be accurate. The Type 7A22 INPUT OVERDRIVE indicator provides an indication that such a signal is present by lighting before the gain calibration changes by 1%.

If the INPUT OVERDRIVE lamp turns on, there are two possible ways to continue:

1. Switch the LF -3 dB POINT selector to DC OFFSET. DC differential signals may then be balanced out as indicated in Table 2-1.

2. Switch the AC-GND-DC switch to AC. DC differential signals up to 1000 V (either input not to exceed 500 V) may be removed by using AC coupling at the input. This necessarily limits the low frequency response to 1.6 Hz (or 0.16 Hz with a 10X probe).

The INPUT OVERDRIVE lamp is insensitive to common-mode overdrives, and it is possible to overload the Type 7A22 without lighting the input overdrive light.

In summary the overdrive indicator will turn on under the following conditions:

- a. The input signal exceeds the differential dynamic range of the amplifier (see Section 1 for table of dynamic ranges).
- b. An input protective fuse is blown. In this case, the light will remain on even if the AC-GND-DC switches are set to GND.
- c. There is a circuit malfunction.

Readout

If the Type 7A22 is to be used in an oscilloscope having readout capabilities, special probes which correct the readout deflection factor for probe attenuation may be used. Divider probes not having the sensing capability may be used with the instrument, but they will not operate the sensing system, and the deflection factor of the plug-in only (as read on the VOLTS/DIV knob) will be displayed.

The +INPUT and -INPUT connectors have an outer ring which is connected to the readout probe sensing device. This allows the main-frame readout to display the correct deflection factor from the probe tip for any probe attenuation. For

example: if a 10X probe is used it will increase the deflection factor, in the readout display, by a factor of 10. Then the actual deflection factor at the probe tip is displayed (see Table 2-2).

TABLE 2-2

TYPE 7A22 Plug In	Main-Frame Displayed Readout		
	Probe Atten used 1 X	Probe Atten used 10X	Probe Atten used 100X
.5 mV	500 μ V	5 mV	50 mV
50 mV	50 mV	500 mV	5V

Trace Identify. With the oscilloscope turned on and a sweep displayed on the CRT, check for approximately 0.2 div of vertical movement of the trace when the IDENTIFY pushbutton is depressed. The vertical scale factor readout associated with the 7A22 will change to the word IDENTIFY.

NOTE

If only one divider probe (or two probes with equal divider ratios) is connected, the deflection factor at the probe tip will displayed; if probes with different divider ratios are connected (e.g., 10X and 100X), the readout will display the deflection factor at the tip of the probe with the larger division ratio (100X).

NOTE

An incorrect CRT readout will occur in the 10V/div position when using the 100X Readout coded probe (P6009, Tektronix Part No. 010-0264-01). When used in 10 V/div setting, reading will show 1V instead of 1KV.

SECTION 3

CIRCUIT DESCRIPTION

introduction

A block diagram description covering the general configuration of each circuit in the Type 7A22 is included in this section. Following the block diagram description is a detailed description of each circuit and the functions of specific components.

Simplified drawings are provided where necessary for easier circuit understanding. Complete schematic diagrams are included in the Diagrams section. These should be referred to throughout the detailed circuit description.

The values of resistors on the schematics are in ohms unless otherwise specified. Capacitor values are indicated in the following manner unless otherwise specified: whole numbers indicate that the value is in pF, decimal numbers indicate that the value is in μF . For example, 33 pF and 0.1 μF .

BLOCK DIAGRAM DESCRIPTION (see Block Diagram Pullout preceding schematics)

Input coupling

A signal applied to the + or —Input connector passes through the input coupling selector switch to the input attenuator circuit. The signals can be AC coupled, DC coupled or disconnected internally. (See Schematic Diagram Number 1).

Input Attenuators

The input attenuators for the + and —inputs are identical and are conventional RC type attenuators. Common resistive elements are adjustable to facilitate matching the — and + attenuators to obtain optimum DC common-mode signal rejection.

The attenuators (Schematic Diagram number 3) are frequency-compensated voltage dividers which provide constant attenuation at all frequencies within the passband of the instrument, while maintaining a constant input time con-

Preamp

From the input attenuators, the signal is coupled to the preamp. The preamp consists of two identical feedback amplifiers connected in a differential configuration. The overall differential gain is approximately 15.

The supply voltages for the two amplifiers are obtained from a common power supply which is bootstrapped to the input to improve the common-mode rejection ratio of the preamp.

Each input is equipped with an overdrive protection circuit consisting of fuses and clamping diodes. For deflection factors from 10 $\mu\text{V}/\text{DIV}$ through 10 mV/DIV the fuse will open if the current exceeds $1/16$ A (approximately 16.5 volts at the input), preventing damage to the input circuitry.

CAUTION

The input protection circuit clamps the input to a fixed voltage when too large an input signal is applied. In the 10 μV to 10 mV positions there is no resistance through the ATTENUATOR switch. There is a possibility of damage to the signal source, since a very large current surge can flow before the fuse opens.

When the LOW FREQ —3 dB POINT selector is in any position other than DC or DC OFFSET and the Input Coupling switch is in DC, there is no on-screen indication of the DC conditions in the preamp. If the differential dynamic range of the amplifier is exceeded and the amplifier is driven into non-linearity or overdrive, an erroneous display is likely.

An overdrive detector circuit is provided to indicate when the preamp is approaching the limits of its differential dynamic range. A front-panel indicating lamp lights when overdrive occurs.

An offset generator is provided to balance out any current in the preamp resulting from signals containing differential components. Offset (variable) allows the varying component to be amplified, and at the same time maintains the amplifier differential capabilities.

Low Frequency — 3 dB Point

The push-pull output of the preamp is coupled through a LOW FREQ —3 dB POINT selector. The selector switches the components of the coupling network in each half of the preamp to select the low frequency —3 dB points (.1 Hz, 1 Hz, 10 Hz, 100 Hz, 1 kHz and 10 kHz). The DC position of the selector bypasses the low frequency selection circuitry and direct-couples the preamp to the Output Amplifier.

Output Amplifier

The signal from the LF -3dB POINT selector is coupled to the gain-switching section of the Output Amplifier. This section of the Output Amplifier is a pair of feedback amplifiers similar to that of the preamp. The VOLTS/DIV switch changes the amplifier gain.

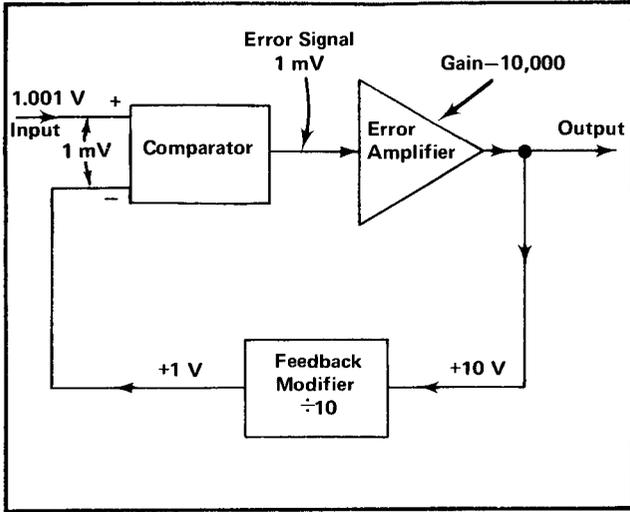

Fig. 3-1. Generalized feedback system showing the relation between input and output.

High Frequency -3 dB Point

The HF -3dB POINT selector switches capacitance across the output of the Gain Switching Amplifier to set the high frequency -3 dB point at any of 9 frequencies; 100 Hz, 300 Hz, 1 kHz, 3 kHz, 10 kHz, 30 kHz, 100 kHz, 300 kHz, and 1 MHz. The capacitance used in the 1 MHz position is adjustable to set the bandwidth to normal value.

Positioning of the trace, and VARIABLE VOLTS/DIV, are provided in the stage following the HF -3 dB POINT selector.

Overall amplifier gain is adjusted in the signal output stage of the Output Amplifier by adjusting the common emitter resistance.

GENERAL INFORMATION

Feedback Amplifiers

Since the Type 7A22 utilizes several multi-stage feedback amplifiers, a brief review of feedback systems in general is given.

Fig. 3-1 represents a generalized feedback system in which it is desired to produce an output signal accurately and stably related to the input. The arrangement of Fig. 3-1 causes the modified output to be nearly equal to the input. Any difference between these is detected by the comparator, which produces an error signal equal to the difference, and applies this error to the amplifier, which amplifies the error and feeds back a correction to reduce the 'original error

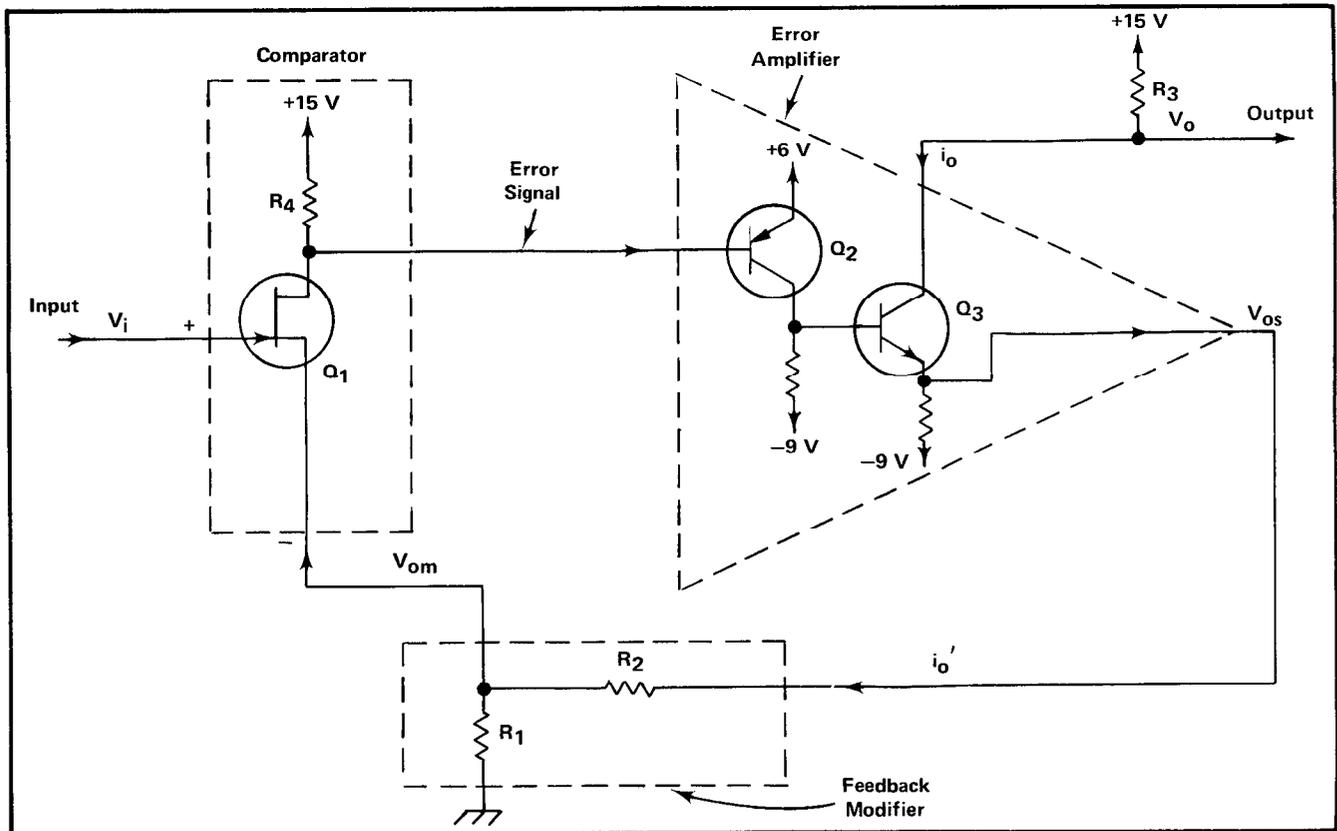

Fig. 3-2. Feedback amplifier (Single-ended version)

pedance of $1\text{ M}\Omega\text{-}47\text{ pF}$ is still seen by the signal source. The $-$ input switch, S201, functions in the same manner as the $+$ input.

Input Attenuators (See Schematic 3)

To produce the vertical deflection factor indicated on the front panel by the VOLTS/DIV switch, the gain of the feedback amplifier in the gain switched amplifier circuit is changed by switching the source resistor (R407) of Q404 A and B (See Schematic 2) for switch positions $10\text{ }\mu\text{V}$ to 10 mV . For switch positions above 10 mV , input attenuators are switched by S108 into the input circuit of the Type 7A22, in conjunction with the gain switching resistors, R407, to produce the selected deflection factors.

These attenuators are frequency-compensated voltage dividers. For DC and low frequency signals, they are primarily resistive dividers (e. g., R108C, R108D) and the voltage attenuation is determined by the resistance ratio in the circuit. **The reactance of the capacitors in the circuit is so high** at the lower frequencies that their effect is negligible. However, at higher frequencies, the reactance of the capacitors decreases and the attenuator becomes primarily a capacitive voltage divider (e.g., C108C, C108D).

In addition to providing constant attenuation at all frequencies within the bandwidth of the instrument, the input attenuators are designed to maintain the same input RC characteristics (1 megohm in parallel with 47 pF) for each setting of the VOLTS/DIV switch. Each attenuator contains an adjustable capacitor (e.g. C108C) to provide correct attenuation at high frequencies, and an adjustable shunt capacitor to provide correct input capacitance.

Gate Current Compensation

The leakage current associated with the gates of the input FETs may be as high as 100 pA . This 100 pA of leakage current (through 1 megohm in parallel with 47 pF) will produce an offset of $100\text{ }\mu\text{V}$, which at high input sensitivities is not acceptable. To compensate this effect, the gates of the input FETs may be adjusted to zero volts by returning R111, R211 through variable controls R115 and R215 to a slightly negative supply voltage (see Fig. 3-4).

Leakage current associated with the gates of the input FETs and the overdrive protection diodes increases rapidly with temperature, approximately doubling for every 10° C . To compensate this increase, a temperature sensitive input current balancing network is included, using thermistors as the sensing elements.

As the voltage across R111 and R211 increases due to increasing FET gate current at increased temperatures, an equal voltage change is produced in the thermistor compensating circuit, maintaining the FET gate level at zero volts.

The gate current compensation becomes inoperative if the straps are removed for high input impedance operation.

Input Amplifier

The input amplifier circuit in the Type 7A22 is made up of two identical feedback amplifiers connected in a differ-

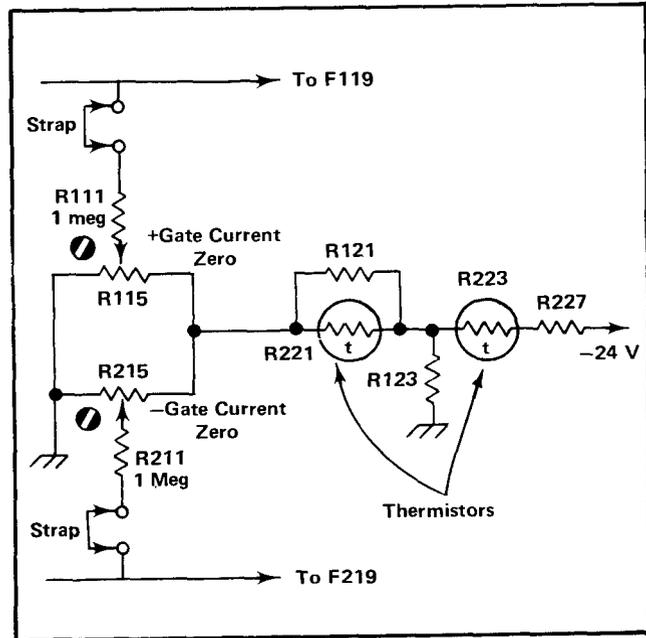

Fig. 3-4. Gate Current Compensation.

ential configuration with a push-pull output. The power supply voltages (except at the output) for each feedback amplifier are obtained from a power supply that is bootstrapped to the common-mode input signal. This improves the CMRR of the amplifier. Input overdrive protection is provided in the input circuit to prevent damage to the semi-conductors if a large overdrive is inadvertently applied to the input.

Any amplifier of this type, in which the feedback is taken to the input element, is likely to exhibit a negative resistance component of impedance at higher frequencies. If the input signal source impedance is inductive with a sufficiently high "Q", the amplifier could oscillate. C115, R116, R117 and C215, C217 compensate for this negative input resistance.

X 15 Preamp. The feedback amplifiers in the $+$ and $-$ inputs are identical except for circuit numbers, and operate in a coupled differential mode as described previously under feedback amplifiers.

In the actual circuit (see Schematic 1) the $+$ feedback amplifier consists of the comparator Q133A, error amplifier Q144A, Q153, feedback modifier R151, R153 and output load resistor R159. R151 is the gain setting resistor for the amplifier, and the approximate gain of the amplifier can be determined by dividing R159 by R151, $(\frac{R_o}{R_i})$.

Diode CR131 is used for temperature compensation of the base-emitter junctions of Q144A and Q144B. This keeps the total voltage across the input stage current-setting resistors R133, R233 constant with temperature, Diode CR144 connected between base-emitter of Q1 44A, protects the transistor against reverse base-emitter breakdown. CI 44 and C244 stabilize the circuit at the higher frequencies.

DC Balance. The DC level at the output of Q153, Q253 is balanced by R258, STEP ATTEN DC BAL. The STEP ATTEN

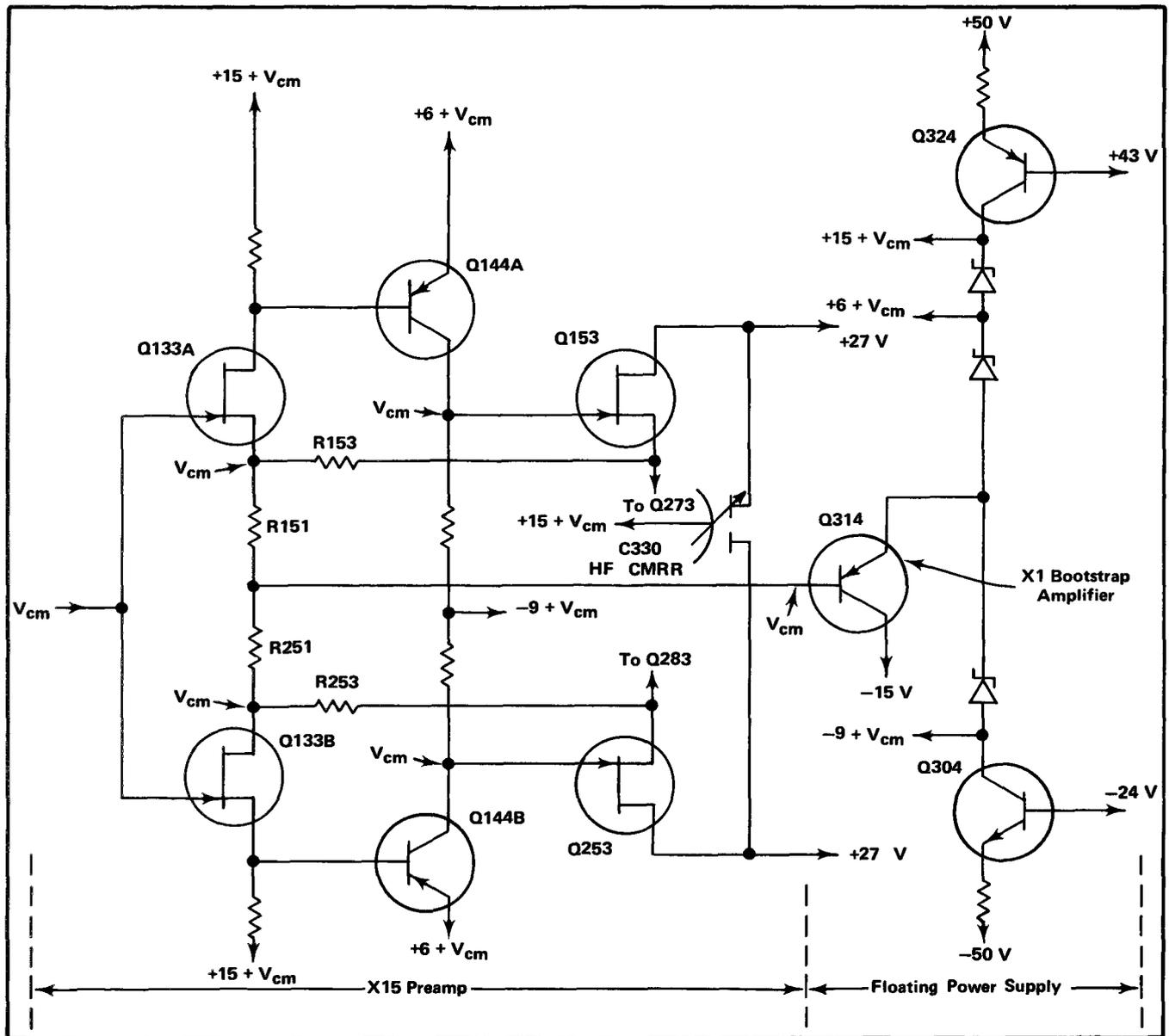

Fig 3-5. Common-mode Rejection using floating power supply.

DC BAL control changes the current through R257, R259, thereby changing the DC balance. It is used to adjust the difference in potential across the output of the $\times 15$ Preamp (pins Z and W) to zero with the input coupling switches at GND and the LOW FREQ -3 dB POINT switch set to DC.

With high frequency common-mode signals the wiring stray capacitance of the $\times 15$ preamp can inject undesirable current into the two output lines at high frequencies. C330 is adjusted to equalize these currents, thus extending the frequency range over which useful CMRR can be obtained.

Floating Power Supply. The supply voltages for the $\times 15$ preamp are obtained from a chain of Zener diode shunt regulators, VR305, VR320 and VR325 connected in series. Current is supplied by two current sources, Q304 and Q324.

C307, C317 and C325 filter out the Zener noise. C315 increases the bootstrap stability at higher frequencies.

Any common-mode changes that occur in the input amplifier, except at the output, are coupled to the power supply through Q314. Q314 is an emitter follower whose gain is maintained very close to unity by the minimum loading presented to its output by the high collector impedance of Q304 and Q324, thus achieving good bootstrap efficiency.

Common Mode Rejection. One of the primary functions of the $\times 15$ preamp is to reject any common-mode component in the input signals, and amplify only the difference. In the extreme case of the inputs tied together and a common voltage applied, the output of the amplifier is ideally zero, and would actually be zero provided that the characteristics

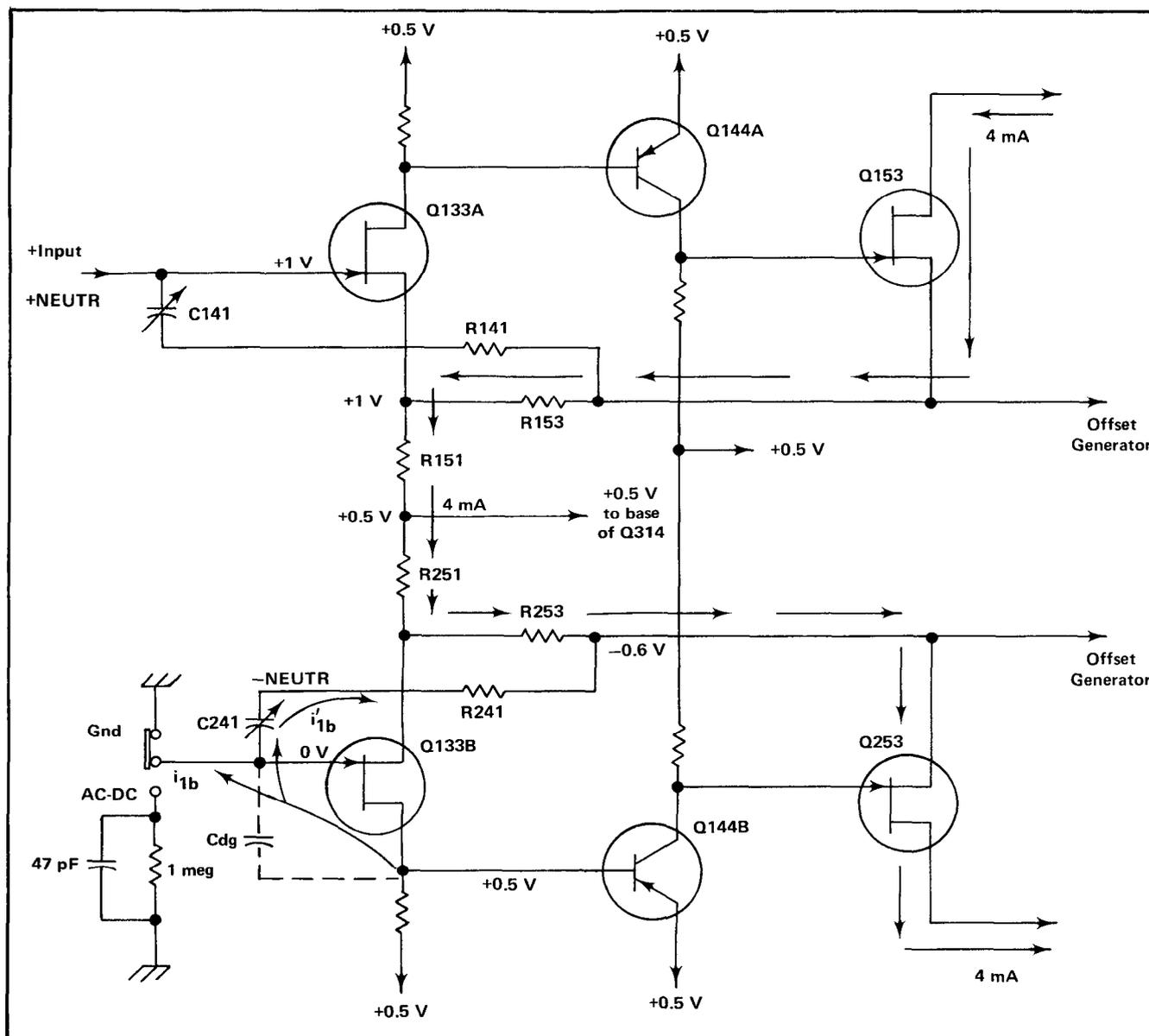

Fig. 3-6. Input cross neutralization.

of all corresponding elements on the two sides of the amplifier (see Fig. 3-5) were exactly matched. In practice any mismatch will cause a differential output. Even with perfect matching, there is still a common-mode output current resulting in an undesirable common-mode signal applied to the subsequent stages of the amplifier (common mode gain).

The floating power supply eliminates these difficulties and improve the CMR. Suppose the input to the bootstrap amplifier is connected to the junction of R151 and R251 (see Fig. 3-5). It can be seen that now the entire power supply and amplifier moves an amount equal to V_{cm} (ie: follows V_{cm}) and that no changes in voltage or current levels occur anywhere within the amplifier as a result of V_{cm} , except for Q153 and Q253 drain to gate voltage. Thus the only mismatch of importance is that of Q153, Q253 amplification

factors, and being in the third stage of the amplifier at a point of relatively large differential signal level, this causes only a small degradation in CMR.

At higher frequencies the inevitable stray capacitances from various points in the $\times 15$ preamp to ground begin to inject significant current into the amplifier as a result of common mode signals. The differential capacitor C330, (Fig. 3-5 or Schematic \diamond) connected from a point in the floating power supply to the two output lines, is used to inject adjustable currents into the output. It can be adjusted to equalize the net output currents resulting from high frequency common mode signals and so extend the range of frequencies over which useful CMRR can be obtained.

Cross Neutralization. The use of a common bootstrap power supply results in an undesirable capacitive coupling

between the two inputs. Consider the effect of applying +1 volt to the +input while keeping the -input at 0 volts (see Fig. 3-6).

The results are (a) an output current of 4 mA, as shown, and (b) a shift of all supply voltages and several other voltage levels by +0.5 V due to the divider action of R151, R251 operating into the bootstrapped power supply system. Specifically, the drain of Q133B also rises +0.5 V and injects a current i_{1b} through the drain to gate capacitance of Q133B and into the -input. If there is any impedance between the -input and ground, i_{1b} will develop a voltage across it which, being applied to the -input subtracts from the original +input and causes an erroneous output (see Fig. 3-7).

Note that the output current flowing through R253 causes its output end (Q253 source) to go to -0.6 V. A capacitor, C241, connected from this point to the -input can be adjusted to divert i_{1b} away from the input line (i_{1b}) and so neutralize the effect of C_{dg} and reduce the -input current to zero. R141 and C1 41 perform a similar function for the +input.

Input Overdrive Protection. Since the input FETs Q133A and B, being semiconductors can be destroyed by sufficiently large overdrive applied directly to them, some input protection is a necessity. The important components of the protection system used in the Type 7A22 are shown in Fig. 3-8A.

There are two different kinds of overdrive associated with the Type 7A22, (a) single-ended overdrive, with one input grounded, and (b) common-mode overdrive, with approximately equal input voltages.

(a) Assume the -input grounded and a steadily increasing voltage on the +input. The chart in Fig. 3-8B indicates the sequence of events: F1 19 will open if the + signal source can supply 1/16 amp of current. If this much current is not present, the +input remains at +16.5 V, with the overdrive current flowing to ground as shown in Fig. 3-8.

Now assume the +input grounded and a steadily increasing -voltage on the -input. The sequence of events is shown in Fig. 3-8C.

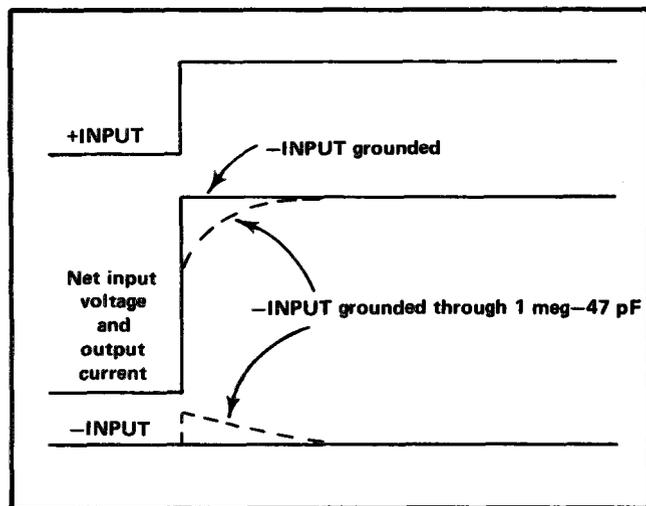

Fig. 3-7. Effects of high impedance to ground in the -INPUT.

(b) For common-mode overdrives the clamping sequence is essentially similar, except the $\times 15$ amplifier does not overload, and the current i_2 does not flow until the input reaches approximately -13 V. The fuse opening current paths are shown in Fig. 3-8A.

For differential overdrive the action is a combination of the + and - single-ended sequences, with the -input supplying i_2 . (In effect a 5 k Ω resistor is connected across the inputs when the differential voltage reaches 3 V). The fuses will not open until one or both inputs reach +16.5 V or -16.5V.

DC Offset. The purpose of the DC offset system is to allow a differential slideback measurement, i.e.: to buck out small DC components of input signals and allow the amplifier to amplify only the varying components, while keeping the differential capability. This means that when a DC voltage is applied across the inputs, some means must be found to balance out the resultant output current. Fig. 3-9 illustrates how this is done.

Fig. 3-9A shows the standing currents for zero input. Fig. 3-9B shows the currents with a 0.25 V DC input applied to the +input. This would cause an i_o' of 1 mA to flow through R151, R251. However, if this 1 mA is supplied as shown by the offset generator, then no net output current results. Both the Q1 33A and Q133B source currents and the output standing currents, i_o' , remain at their zero signal value, 2 mA and 5 mA respectively.

Offset Generator. The offset generator produces the adjustable balanced offset current for use in the $\times 15$ preamp. Due to the wide range of the offset system (200,000 div at 10 μ V per div) stable components are used and circuit techniques which minimize drift and noise are employed in the offset generator. A 10 turn coarse and 1 turn fine OFFSET control is used to obtain adequate resolution at low deflection factors.

The functional arrangement of the offset generator is shown in Fig. 3-10. In the reference voltage generator the OFFSET control, R270, taps an adjustable portion (V_{1b}) of the voltage across the reference Zener VR270, and a fixed voltage (V_{1a}) is taken from the voltage divider formed by R271, R279 (approximately 50% of the reference voltage); thus, the difference voltage ($V_{1b}-V_{1a}$) is adjustable over the range of at least -4 V to +4 V.

This adjustable difference voltage is applied to the inputs of a balanced feedback amplifier conceptually similar to that described previously under differential configuration. In amplifier "A", the feedback action forces the -input voltage (also the output voltage) V_{2a} to follow the +input V_{1a} . In a similar manner, V_{2b} follows V_{1b} in amplifier "B". The differential input ($V_{1b}-V_{1a}$) is therefore reproduced across resistors R287, R289. The resultant current, $\frac{V_{2b}-V_{2a}}{R_{287}+R_{289}}$, which is "offset", flows through the FET (Q273, Q283) output stages of the amplifier and out their drains to the $\times 15$ preamp.

When the offset is not in use V_{1b} is switched to the fixed divider (R273, R277) by the OFFSET ON/OFF switch (part of the LF -3 dB POINT switch). V_{1a} is adjustable over a small range with respect to V_{1b} by the COARSE DC BAL control, whose purpose is to adjust out any initial DC unbalance in the $\times 15$ preamp, and to bring its output to zero with zero input.

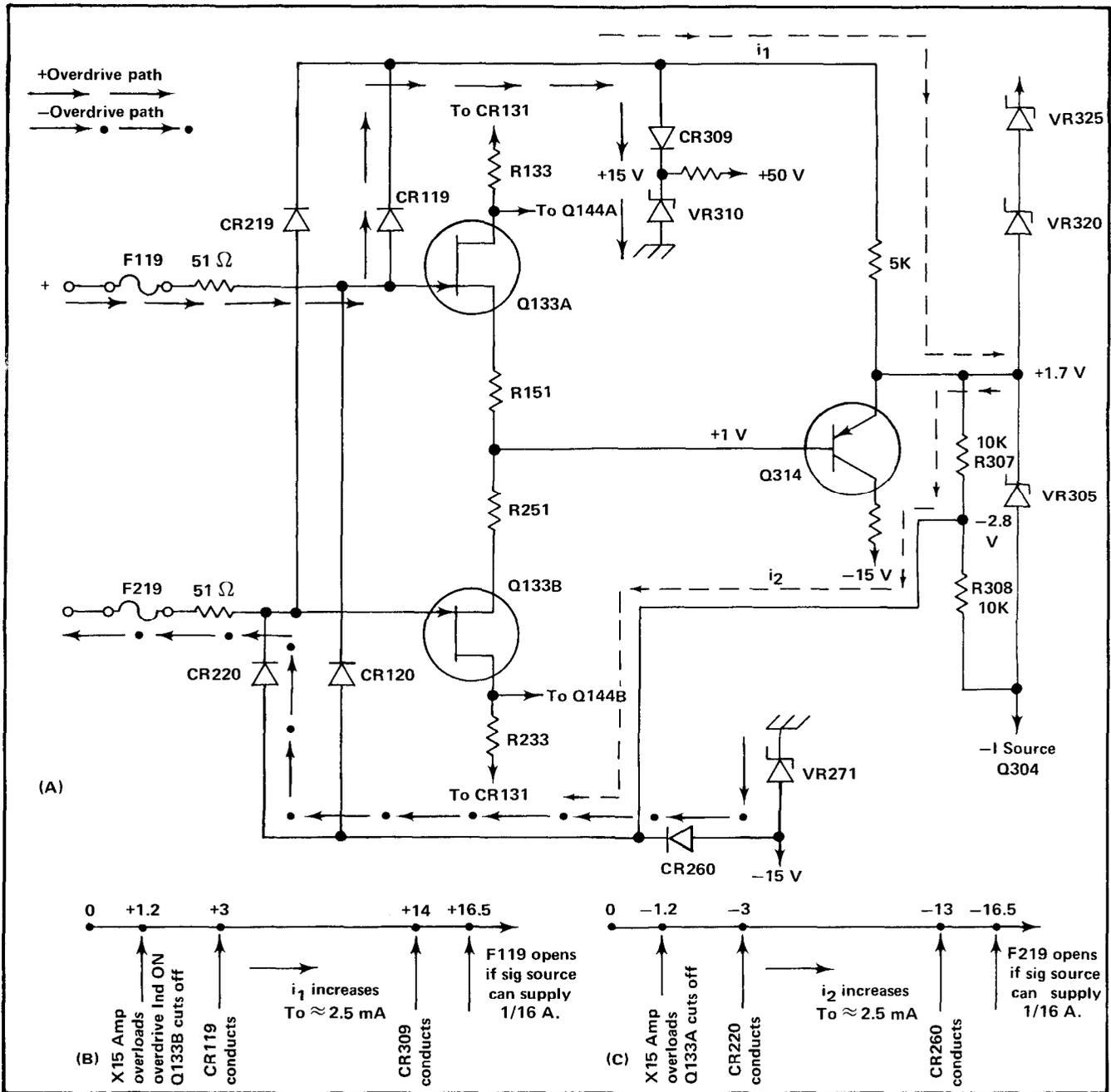

Fig. 3-8. (A) Overdrive Protection System showing current paths. (B, C) Sequence of events leading to excessive overdrive.

In the actual circuit, the reference voltage generator is modified by the addition of a FINE OFFSET control (R265), which changes the effective range of the 10 turn COARSE potentiometer by means of two voltage dividers, one connected to each end of the COARSE control. A capacitor filters out Zener noise from the reference voltage.

The feedback amplifiers A and B are composed of Q264A, Q273 and Q264B, Q283 respectively, with the reference input applied to the emitters of dual transistor Q264 and the feedback to its bases. Current source Q284 supplies operating current for the amplifiers.

Input Overdrive Indicator. When the LF-3dB POINT selector is in a position other than DC, there is no on-screen indication of the DC conditions in the $\times 15$ preamp, and it may be driven into non-linearity or overload by a DC component, leading to erroneous displays. The input overdrive indicator detects this condition and indicates by means of a warning light that the $\times 15$ preamp is approaching the limits of its dynamic range.

The indicator consists of a threshold detector (CR341, CR343, Q344) and a monostable lamp driver (Q334, Q354). In the quiescent state, while no overdrive exists, CR341,

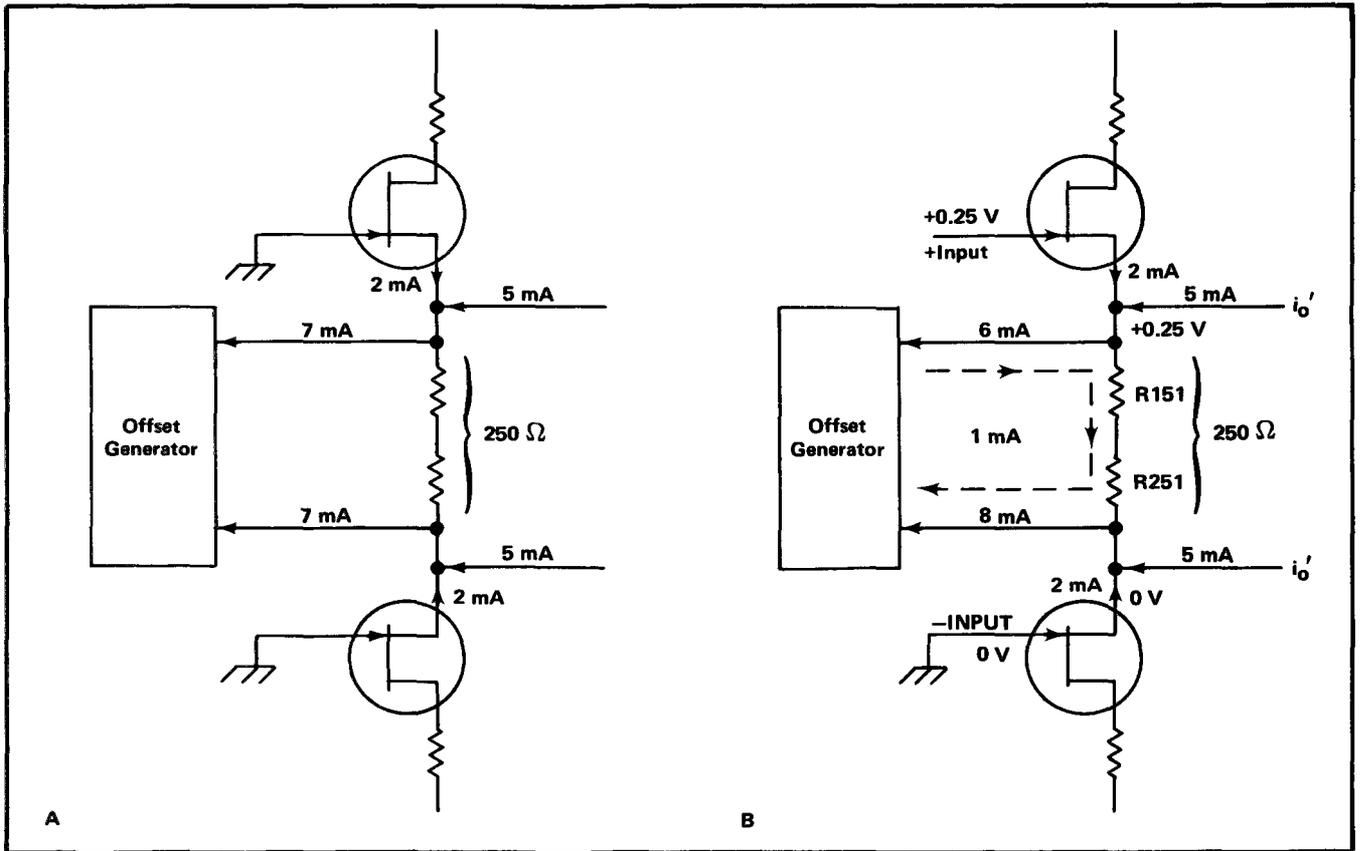

Fig. 3-9. Offset system showing (A) Conditions with zero offset, (B) 0.25 V DC offset.

CR343, Q344, Q334 and Q354 are all cut off. R341 and R343 form a voltage divider to set the emitter of the threshold detector, Q344, at approximately +32 V.

Now suppose one of the $\times 15$ preamp output lines exceeds +33.4 V; CR341 (or CR343) and Q344 collector current turns on Q334 via R347. Q334 collector current turns on Q354 via R333, and the resulting negative going step at Q354 collector turns on the lamp. This causes current in R349 to turn Q334 on harder. If the overdrive is removed immediately, Q344 turns off. However, the current through C349, R349 keeps Q334, Q354 and the lamp on until C349 is charged to its new voltage (approximately 1 second) and the current through R337 exceeds that in R349, R337. This keeps Q334 off for approximately 1 second, even if Q344 receives another overdrive signal. Thus for repetitive overdrives, (up to about 10 kHz), the monostable free-runs and the lamp flashes at approximately a 2 second rate. (Above 10 kHz the high speed AC effectively charges up the stray capacitance and makes the circuit act as if it had a DC overload.) If, however, a DC overload keeps Q344 on, the end of C349 discharge does not turn Q334 off since it is kept on by current through R347. Thus, the lamp stays on until the overdrive is removed.

LF — 3 dB POINT Selector. This switch selects the low frequency —3 dB point of the amplifier and has a range of 0.1 Hz to 10 kHz in decade steps. Selection is done by switching the resistor and capacitor of a pair of capacitor couplings in each leg of the amplifier. Fig. 3-11 shows half of the selector, with the switch split up into its functional elements.

For the 100 Hz to 10 kHz positions, C1 56 is used and resistors R353C, R353B and R353A are switched to the output in the following combinations:

—3 dB frequency	100 Hz	1 kHz	10 kHz
output resistors	R353C	R353 & R353B	R353C & R353A

Whenever R353A or R353B is not on the output side of C1 56, it is placed across the input, to keep the high frequency load resistance seen by V_{in} constant.

C353A is switched across C1 56 for the lower 3 ranges, (0.1 Hz, 1 Hz and 10 Hz) and C156 is shorted out for DC coupling. Resistor R157 adds a small increment in gain when C156 is used to compensate for the loss of gain through the capacitive divider formed by C1 56 and stray capacitance C_s .

When the 0.1 Hz to 10 Hz positions are in use, C353A may be rapidly pre-charged by switching to the 10 Hz position momentarily.

OUTPUT AMPLIFIER (See Schematic)

Gain Switching Amplifier

The gain switching amplifier (Q404, Q414, Q424, Q524) is a balanced differential configuration very similar to the $\times 15$ preamp but with a fixed power supply. Gain switching is accomplished by switching R407.

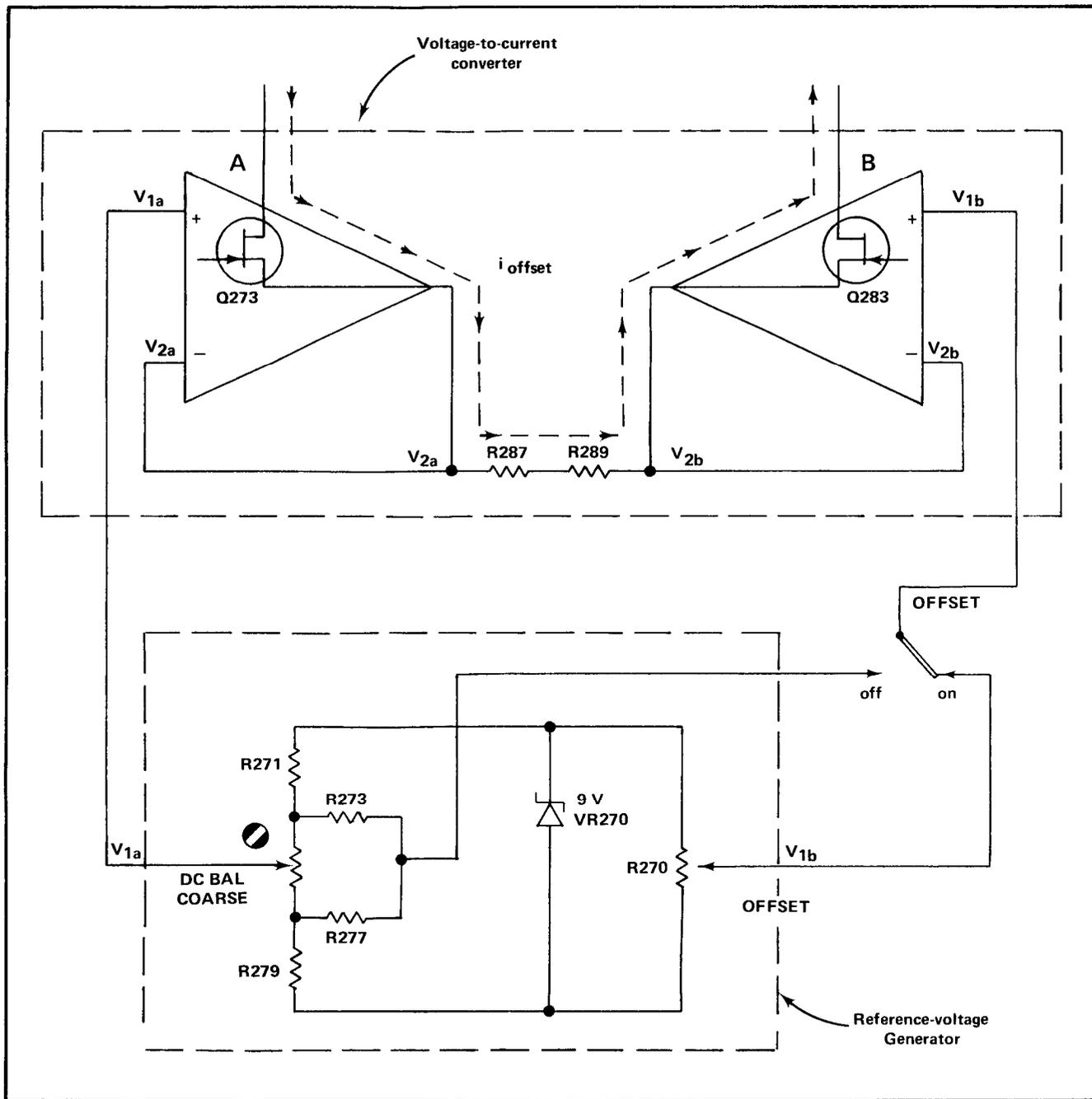

Fig. 3-10. Functional arrangement of the offset generator.

Diodes CR413, CR513 prevent base-emitter reverse breakdown in Q414 under overdrive conditions: CR419, CR519 limit the output current that can flow through Q424, Q524. CR415, CR417 and CR515, CR517 prevent the bases of Q424, Q524 from swinging too far from the emitter, preventing breakdown and ensuring a fast, clean overdrive recovery. The AC STEP ATTEN BAL adjustment (R505) in series with the source of Q404B, develops a small adjustable voltage which removes any initial unbalance in the gate-to-source voltages of Q404 A & B. The AC STEP ATTEN BAL also sets the voltage across

gain-setting resistor R407 to zero when the differential input (gate-to-gate) voltage is zero.

VAR BAL (R425) is used to balance the output currents of Q424 and Q524 with zero input to the amplifier.

The gain switched amplifier has excellent overdrive characteristics so that the full dynamic range of the input amplifier can be used. It is gain-switched over a range of about 1,000:1 with no significant change in bandwidth or any other characteristics.

HF —3 dB POINT Selector. The HF —3 dB POINT selector simply switches different values of capacitance across the output of the gain-switched stage to set the high frequency —3 dB point of the amplifier. The —3 dB point is adjusted in the 1 MHz position by C425.

Variable Output Stage

The variable output stage (Q434, Q534) does not contribute much voltage gain, but it performs a number of other functions. The configuration is a collector loaded, common emitter amplifier with emitter degeneration, the gain (collector signal current vs. input voltage) being determined by the total emitter to emitter resistance. This resistance is adjusted over a 2.5:1 range by the VAR control, R535, which provides a fine control of gain in the uncalibrated position, and interpolates between the steps of the VOLTS/DIV switch.

POSITION control is obtained by feeding adjustable currents into the emitters of Q434, Q534, via resistors R431, R531. This current adds to or subtracts from the signal current developed in the emitter resistors R432, R535, R532, and flows out of the collectors into the signal and trigger output amplifiers.

Signal Output Amplifier

The signal output amplifier (Q444, Q544) is a push-pull common emitter configuration with emitter degeneration to improve the stability and linearity of the circuit. The gain of the stage is determined by the total emitter-to-emitter resistance, which is adjustable by GAIN control (R540) to facilitate calibration of the instrument. The gain of the amplifier is set in the 1 mV position of the VOLTS/DIV switch.

R443, R543 equalize the power in Q444, Q544 under dynamic conditions, thereby eliminating thermal distortion. C443, C543 are high-frequency by-pass capacitors.

Trigger Output Amplifier

The trigger output stage (Q454, Q554) is almost identical to the signal output stage, except the stage gain is not adjustable, so that the output, while nominally the same as the signal output level, can in fact have quite a wide tolerance.

INDICATOR OSCILLOSCOPE READOUT

General

The readout block consists of switching resistors and a probe sensing device. The switching resistors are used to signal to the Indicator Oscilloscope the setting of the VOLTS/DIV switch. R618A, R618B, and R618G select the number 1, 2, or 5 depending upon the combination that is switched in. R618C, R618D, R618L, and the output of the probe sensing device (Q614) select the decimal point (number of zeroes) again depending on the switched-in resistor combination. R618E, R618F, and R618N select the Volts sub-unit, either m (milli), μ (micro), or no sub-unit. R618H and R618K select

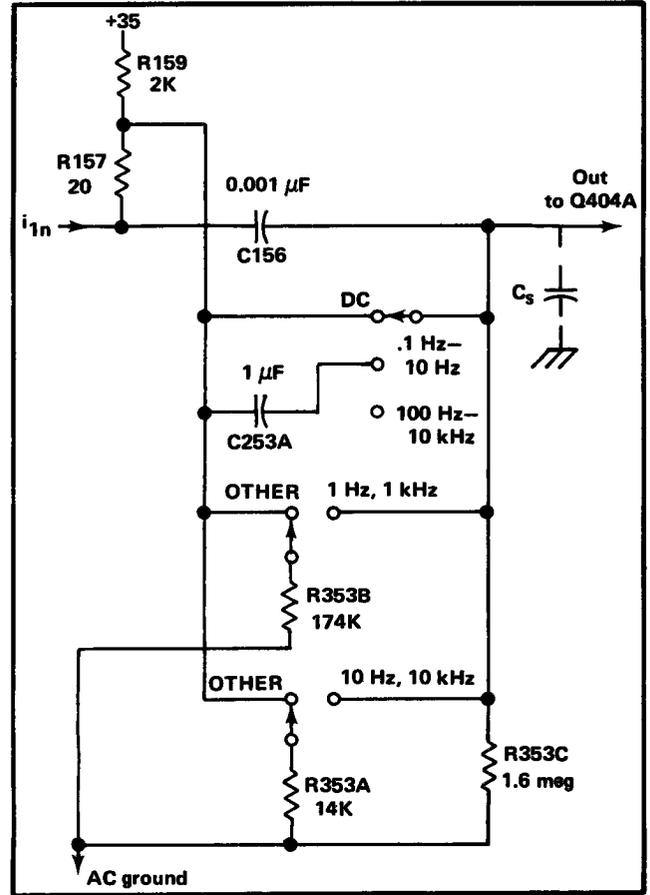

Fig. 3-11. Partial Low Frequency —3 dB Point selector for + Input amplifier.

the symbol V (volts). R618J and R618M select the symbol > when the VARIABLE VOLTS/DIV knob is in the uncalibrated position. Refer to the Schematic Diagram of the VOLTS/DIV Switch to find the resistors associated with a particular setting of the VOLTS/DIV switch.

Probe Sensing

The probe sensing device (Q614) identifies the attenuation of the probe connected to the front panel connector, by sensing the amount of current flowing from the current sink through the probe coding resistance, and adjusts the read-out display so that the actual probe tip deflection factor is displayed.

The probe connected to the + (or -) INPUT connector forms a voltage divider with R610 (R620) through CR615 to the -15 V supply. This forward biases CR610 (CR620) allowing current to flow through R630, reducing the bias on Q614. The bias voltage, applied to the base of Q614, is set by the probe coding resistance of the divider probe.

When the -15 V clock pulse is applied to interface connector B33, Q614 is interrogated and its collector currents (determined by the base voltage and emitter resistor, R614) is added to the column current through interface connector A37.

With a 1 X probe (or no probe) connected, Q614 is turned off, and the deflection factor, in the readout display, is determined by the setting of the Readout Switch, S407, (part of the VOLTS/DIV switch) only.

With a 10X probe connected to the input (+ or -) , the bias on Q614 will allow 100 μ A of collector current to flow. This increases the deflection factor (in the readout display) by a factor of 10.

When different-attenuation divider probes are connected to the + and - INPUT connectors, the displayed readout will be the probe tip deflection factor of the larger divider. For example: if a 10X probe is connected to the +INPUT and a 100X probe is connected to the -INPUT the readout will display the deflection factor at the tip of the 100X probe. The 100X probe will set the bias on Q614 to allow 200 μ A of collector current which will increase the deflection factor (in the readout display) by a factor of 100.

This means that the Indicator Oscilloscope displayed read-out will give the correct deflection factor from the probe tip, for a single probe or two probes having the same attenuation factor, whereas the VOLTS/DIV knob on the plug-in will display only the plug-in deflection factor.

Trace Identify

The TRACE IDENTIFY button, when pressed, does two things:

1. It causes the trace, representing the output of the Type 7A22, to move a small amount by inserting a 2 k Ω resistor, R622, from ground through CR630 to the junction of R632 and R634. This shunts a small amount of the output current causing the trace to move.

2. Forms a voltage divider from the -15 V supply through R630 and R622, placing the base of Q614 at approximately -1.5 V. This low value of bias will cause Q614 to turn on hard (1,000 μ A collector current) when interface connector B33 is interrogated, erasing the readout display and causing the word "IDENTIFY" to appear.

These two actions aid in identifying the Type 7A22 trace when multiple traces are displayed. When the IDENTIFY button is released, the readout is restored to its previous display.

For more specific information on the operation of the system, refer to the appropriate Indicator Oscilloscope manual.

SECTION 4

MAINTENANCE

Introduction

Information which will aid in keeping the Type 7A22 operating at its peak performance is contained in this section. Cleaning, lubricating and visual inspection hints are included under preventative maintenance. The section on corrective maintenance includes troubleshooting and corrective procedures. Parts identification and soldering techniques are included where necessary.

PREVENTIVE MAINTENANCE

General

The instrument should be cleaned, inspected and recalibrated at regular intervals. The recommended interval for average operating conditions is every 6 months or every 1000 hours of operation, whichever occurs first.

Cleaning the Front Panel

Loose dust may be removed with cloth and a dry paint brush. Water and mild detergents such as Kelite or Spray White may be used.

CAUTION

Avoid the use of chemical agents which might damage the plastics used in this unit. Avoid chemicals such as benzene, toluene, xylene, acetone or similar solvents.

Cleaning the Interior

Cleaning of the interior of the unit should precede calibration, since the cleaning process might alter the settings of the calibration adjustments.

To clean the interior, use low-velocity compressed air to blow off the accumulated dust. High velocity air streams should be avoided to prevent damage to components.

WARNING

Use an eye-shield when cleaning with pressurized air. Hardened dirt can be removed with a paint brush, cotton tipped swab or cloth dampened with a water and mild detergent solution. Avoid the use of chemical cleaning agents that might damage the plastic parts.

Visual Inspection

The unit should be inspected occasionally for such defects as poor connections, broken or damaged circuit boards, improperly seated transistors and heat-damaged parts. The remedy for most visible defects is obvious. However, damage from overheating is usually a symptom of less obvious trouble; and unless the cause is determined before parts are replaced the damage may be repeated.

Transistor Checks

Periodic preventive maintenance checks on the transistors used in the unit are not recommended. The circuits within the unit generally provide the most satisfactory means of checking transistors usability. Performance of the circuits is thoroughly checked during recalibration, and standard transistors will usually be detected at that time.

Calibration

To insure accurate measurements, the Type 7A22 calibration should be checked after each 1000 hours of operation or every six months if used intermittently. Complete calibration instructions are contained in Section 5.

The calibrated procedure can be helpful in isolating major troubles in the unit. Moreover, minor troubles not apparent during regular operation may be revealed and corrected during calibration.

CORRECTIVE MAINTENANCE

General

Replacement of some parts in the unit should be done by following a definite procedure. Some procedures, such as soldering and replacing components on the circuit boards, are outlined in this portion of the manual.

Many electrical components are mounted in a particular way to reduce or control stray capacitance and inductance. When selecting replacement parts, it is important to remember that the physical size and shape of a component may affect its performance at high frequencies. When a repair is made, calibration and performance of the relevant portions of the circuit should be checked. Refer to Table 4-1 and to the Performance Check/Calibration procedure in Section 5 and perform the applicable steps.

TABLE 4-1

Areas of Repair	Checks and Adjustments Affected	Section 5 Calibration Step
Input Coupling switches and cables	Input R and C, Attenuator compensation, CMRR, LF response, Gain	6, 13, 14, 15, 16, 17, 18, 19, 20, 21, 22
Input Attenuators	1X input C, Cross Neutralization, DC BAL, CMRR Com-non-Mode dynamic range, Differential dynamic range, Offset range, Noise, Input protection system	3, 6, 10, 11, 12, 13, 14, 20, 22, 23, 24
Preamp	Gain, 1 MHz freq. response, Overdrive indicator	
LF -3 dB POINT	Gain, LF freq. response, 1 MHz freq. response	6, 20, 21
Overdrive Indicator	Dynamic range	23, 24
Gain Switched Amp	Gain, Deflection factor tracking, AC Atten Bal, HF -3 dB POINT, 1 MHz freq. response, Overdrive recovery Variable Balance	1, 2, 6, 8, 20, 26
Offset Generator	Offset Range, DC Bal, CMRR	3, 10, 22
Output Amplifier	HF -3 dB POINTS, Var balance, Variable range, Gain	2, 6, 7, 20

Obtaining Replacement Parts

Standard Parts. All electrical and mechanical part replacements for the Type 7A22 can be obtained through your local Tektronix Field Office or representative. However, many of the standard electronic components can be obtained locally in less time than is required to order them from Tektronix, Inc. Before purchasing or ordering replacement parts, check the parts lists for value, tolerance, rating and description.

NOTE

When selecting replacement parts, it is important to remember that the physical size and shape of the component may affect its performance in the instrument, particularly at high frequencies. All replacement parts should be direct replacements unless it is known that a different component will not adversely affect instrument performance.

Special Parts. Some parts are manufactured or selected by Tektronix to satisfy particular requirements, or are manufactured for Tektronix to our specifications. These and most

mechanical parts should be ordered through your Tektronix Field Engineer or Field Office. See Parts Ordering Information and Special Notes and Symbols on the page immediately preceding Section 6.

Soldering Techniques

Circuit Boards. Use ordinary 60/40 solder and a 35- to 40-watt pencil type soldering iron on the circuit boards. The tip of the iron should be clean and properly tinned for best heat transfer to the solder joint. A higher wattage soldering iron may separate the etched wiring from the base material.

The following technique should be used to replace a component on the circuit board. Most components can be replaced without removing the board from the unit.

1. Grip the component lead with long-nosed pliers. Touch the soldering iron to the lead at the solder connection. Do not touch the soldering iron tip directly on the board, as it may damage the board.

2. When the solder begins to melt, pull the lead out gently. This should leave a clean hole in the board. If not, the hole can be cleaned by reheating the solder and placing a sharp object, such as a toothpick or pointed tool, into the hole to clean it out.

3. Bend the leads of the new component to fit the holes in the board. Cut the leads of the new component to the same length as those of the old component. Insert the leads into the board until the component is firmly seated against the board, or as positioned originally. If it does not seat properly, heat the joint, and gently press the component into place.

4. Apply the iron and a small amount of solder to the connection to make a firm solder joint. To protect heat-sensitive components, hold the lead between the component body and the solder joint with a pair of long-nose pliers or other heat sink (see Fig. 4-1).

5. Clip the excess lead that protrudes through the board.

6. Clean the area around the soldered connection with flux-remover solvent to maintain good environmental characteristics and appearance. Be careful not to remove information printed on the board.

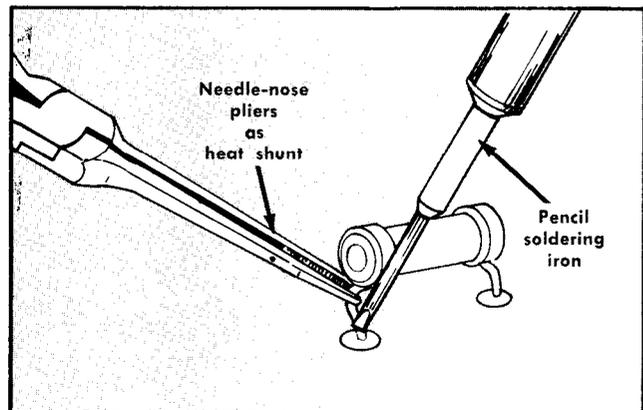

Fig. 4-1. Removing or replacing component on circuit board.

CAUTION

Silk-screen lettering dissolves when contacted by flux-remover.

Metal Terminals. When soldering metal terminals (interconnecting plug pins, switch terminals, potentiometers, etc.) ordinary 60/40 solder can be used. The soldering iron should have a 40- to 75-watt rating with a 1/8 inch wide chisel-shaped tip.

Observe the following precautions when soldering to metal terminals:

1. Apply heat only long enough to make the solder flow freely.
2. Apply only enough solder to form a solid connection; excess solder may impair the function of the part.
3. If a wire extends beyond the solder joint, clip the excess close to the joint.
4. Clean the flux from the solder joint with a flux-remover solvent to maintain good environmental characteristics and appearance.

Specific Component Replacement Information

WARNING

Disconnect the instrument from the power source before removing or replacing components.

The pushbutton switches are not repairable and should be replaced if defective. Components which are mounted on the circuit board associated with the pushbutton switch can be replaced using the normal replacement procedure. See the information under Light-Bulb Replacement for bulb replacement. Use the following procedures to replace the +INPUT and -INPUT pushbutton switches.

1. AC-GND-DC (+ INPUT) Switch

- a. Set the front panel controls as follows:

POSITION	Midrange
STEP ATTEN DC BAL	Midrange
VOLTS/DIV	10 V
HF —3 dB POINT	1 MHz
LF —3 dB POINT	DC OFFSET
DC OFFSET (FINE)	Midrange
DC OFFSET (COARSE)	5 turns from either extreme
- b. Remove all front panel knobs.
- c. Remove the GND binding post assembly.
- d. Remove the nut and washer from the POSITION and DC OFFSET shafts.
- e. Remove the plastic bushing from the VOLTS/DIV shaft.
- f. Remove the front panel overlay.
- g. Without unsoldering any leads, carefully push the dual DC OFFSET potentiometers out of the front panel and lift them out of the way.
- h. Unsolder and unplug the connecting leads from the AC-GND-DC switch.
- i. Remove four corner screws and remove the front sub-panel.

i. Remove the two screws securing the AC-GND-DC switch to the front sub-panel and remove the switch.

k. Replace by reversing the above procedure.

2. AC-GND-DC (— INPUT) Switch

- a. Perform step 1, parts a through f, of Specific Component Replacement.
- b. Loosen the setscrew on the collar connecting the GAIN shaft to the pot coupler and pull the shaft out of the front panel.
- c. Unsolder and unplug the connecting leads from the AC-GND-DC switch.
- d. Remove the four corner screws and remove the front sub-panel.
- e. Remove the two screws securing the switch to the front panel.
- f. Remove the switch.
- g. Replace by reversing the above procedure.

3. Light-Bulb Replacement, + INPUT and - INPUT Push-Button Switches

Two types of pushbutton switches which have different light designs are in use. One switch design uses a metal cover over the light bulb(s) on the back of the switch; the other type does not. Either or both types of switches may be used in the 7A22.

To replace light bulbs in the pushbutton switches, use the following procedure:

- a. Remove the applicable INPUT switch as described in steps 1 and 2.
- b. On switches with the metal cover, remove the screw holding the cover and remove the cover.
- c. Clip off the bulb leads near the bulb body.
- d. Remove the leads from the circuit board.
- e. Remove the excess solder from the circuit board with a vacuum-type desoldering tool.
- f. Solder the new bulb to the circuit board (replace cover).
- g. Replace the switch in the instrument.

4. Bandwidth Circuit Board

- a. Set the LF and HF —3 dB POINT Selectors to either extreme.
- b. Loosen the setscrews securing the LF —3 dB POINT shaft to the collar on the cam switch. Pull the shaft forward until it clears the collar.
- c. Loosen the setscrews securing the HF —3 dB POINT shaft to the collar on the cam switch. Pull the shaft forward until it clears the bandwidth board.
- d. Loosen the setscrew securing the GAIN shaft to the collar on R540. Pull the shaft forward until it clears the bandwidth circuit board. Loosen the setscrew securing the collar to R540 and remove the collar.
- e. Loosen the four circuit board retaining screws and lift out the Bandwidth Circuit Board.
- f. Unclip the leads from solderless connectors A, AN, AP, AO, and D.
- g. Replace by reversing the above procedure.

CAUTION

Repair of cam-type switches should be undertaken only by experienced personnel. Switch alignment and spring tension of the contacts must be carefully maintained for proper operation of the switch. For assistance in maintenance of the cam-type switches, contact your local Tektronix Field Office or representative.

5. Cam-Type Switches

NOTE

A cam-type switch repair kit including necessary teals, instructions and replacement contacts is available from Tektronix, Inc. Order Tektronix Part No. 040-0541-00.

The cam-type switch consists of a rotating cam, which is rotated by a front-panel knob, and a set of contacts mounted on the adjacent circuit board. These switch contacts are actuated by lobes on the cam. The VOLTS/DIV, LF -3 dB POINT and HF -3 dB POINT cam-type switches can be disassembled for inspection, cleaning, repair or replacement, as follows:

A. LF -3 dB POINT and HF -3 dB POINT Switches

1. Remove the Bandwidth board as described in step 4.
2. Remove the two screws which hold the metal covers in place. (The front switch on the Bandwidth board is the LF -3 dB POINT Selector and the rear switch is the HF -3 dB POINT Selector). The switches are now open for cleaning or inspection.
3. To completely remove either of the two switches from the board, remove the four screws (from the back side of the board) which hold the cam assembly to the circuit board.
4. To remove the cam from the front support block, remove the retaining ring from the shaft on the front of the switch and slide the cam out of the support block. Be careful not to lose the small detent roller (between detent and detent spring).
5. To replace defective switch contacts, unsolder the damaged contact and clean solder from the hole in the circuit board. Position the new contact in the hole in proper alignment relative to the other switch contacts and with the mating area on the circuit board (alignment tool provided in switch repair kit). Solder the new contact into place; be sure that the spring end of the contact has adequate clearance from the circuit board.
6. To re-install the switch assembly, reverse the above procedure.

B. VOLTS/DIV Switch

1. Remove the Bandwidth board as described in step 4.
2. Remove the two screws which hold each of the metal switch covers in place.
3. Push the VARIABLE (CAL IN) to the 'IN' position.

4. Loosen the set screw which secures the VARIABLE shaft to the VARIABLE control assembly.
5. Pull the VARIABLE shaft through the front of the instrument.
6. Remove the 4 screws (from the rear side of the board) which hold the rear cam assembly to the circuit board.
7. Remove the rear cam assembly.

To remove the front cam switch assembly, perform the preceding steps and then proceed as follows:

1. Remove the VOLTS/DIV knob.
2. Loosen the ½-inch hex bushing nut which secures the front support block.
3. Remove the plastic bushing from front of panel.
4. Remove the retaining ring from the shaft at the front of the switch.
5. Remove the 4 screws which secure the support blocks to the board.
6. Loosen the 2 set screws in the half of the flexible coupling and remove coupling.
7. Remove the rear support block by carefully lifting the block away from the circuit board far enough to clear the alignment prelection on the bottom of the block. Carefully slide the rear block toward the rear (off the shaft).
8. Slide the cam shaft carefully (keep cam lobes clear of contacts) out of the front support block and bushing assembly.
9. To re-assemble, reverse the above procedure.

6. Interconnecting Pins

Interconnecting pins are used on the Type 7A22 to interconnect circuit boards. When interconnection is made at a circuit board, the pin is soldered into the board. Two types of mating connectors are used for these interconnecting pins. If the mating conector is mounted on a plug-on circuit board, a special socket is soldered into the board. If the mating connector is on the end of a lead, an end-lead pin connector (which mates with the interconnecting pin) is used. The following information provides the replacement procedures for the types of interconnecting methods.

A. CIRCUIT-BOARD PINS

NOTE

A pin replacement kit including necessary tools, instructions and replacement pins is available from Tektronix, Inc. Order Tektronix Part No. 040-0542-00.

To replace a pin which is mounted on a circuit board, first disconnect any pin connectors. Then unsolder the damaged pin and pull it out of the circuit board with a pair of pliers. Be careful not to damage the wiring on the board with too much heat. Ream out the hole in the circuit board with a 0,031 -inch drill. Then remove the ferrule from the new interconnecting pin and press the new pin into the hale in

the circuit board. Position the pin in the same manner as the old pin. Then, solder the pin on both sides of the circuit board. If the old pin was bent at an angle to mate with a connector, bend the new pin to match the associated pins.

B. CIRCUIT-BOARD PIN SOCKETS

The pin sockets on the circuit boards are soldered to the rear of the board. To replace one of these sockets, first unsolder the pin (use a vacuum-type resoldering tool to remove excess solder). Then straighten the tabs on the socket and remove it from the hole in the circuit board. Place the new socket in the circuit board hole and press the tabs down against the board. Solder the tabs of the socket to the circuit board; be careful not to get solder into the socket.

NOTE

The spring tension of the pin sockets ensures a good connection between the circuit board and the pin. This spring tension can be destroyed by using the pin sockets as connecting points for spring-loaded probe tips, alligator clips, etc.

C. END-LEAD PIN CONNECTORS

The pin connectors used to connect the wires to the interconnecting pins are clamped to the ends of the associated leads. To replace damaged end-lead pin connectors, remove the old pin connector from the end of the lead and clamp the replacement connector to the lead.

Some of the pin connectors are grouped together and mounted in a plastic holder; the overall result is that these connectors are removed and re-installed as a multi-pin connector when it is replaced. An arrow is stamped on the circuit board and a matching arrow is molded into the plastic housing of the multi-pin connector. Be sure these arrows are aligned as the multi-pin connector is replaced. If the individual end-lead pin connectors are removed from the plastic holder, note the color of the individual wires for replacement.

TROUBLESHOOTING

Introduction

The following information is provided to facilitate troubleshooting of the Type 7A22. Information contained in other sections of this manual should be used along with the following information to aid in locating the defective component. An understanding of the circuit operation is very helpful in locating troubles. See the Circuit Description Section for complete information.

General

If trouble occurs in the Type 7A22, the following procedure is recommended to accomplish rapid and effective repairs.

1. Check that the plug-in unit and the oscilloscope connectors are not damaged, and that the plug-in unit is properly inserted.

2. Inspect the front panels of the Type 7A22 and indicator oscilloscope to be sure that the trouble is not from an incorrect control setting.

3. Insure that the indicator oscilloscope is not at fault by inserting a known-good plug-in unit and checking its operation.

4. Determine all trouble symptoms.

5. Perform a visual inspection of the Type 7A22.

6. Repair or replace obviously defective parts.

7. Troubleshoot the Type 7A22 as necessary.

8. Recalibrate the Type 7A22.

Indicator Oscilloscope

The quickest check of the oscilloscope is to use it with a good plug-in unit, or check the questionable plug-in with another oscilloscope. Refer to the oscilloscope manual to verify proper operation of the oscilloscope.

Operating Procedures and Control Settings

Refer to the Operating Instructions Section of this manual to verify operating procedures and front panel control settings of the Type 7A22.

Trouble Symptoms

The Type 7A22 response to all front panel controls should be observed. The first-time operation in Section 2 or the Performance Check in Section 5 may be used for this purpose. All trouble symptoms should be evaluated and compared against each other. A casualty will often create a combination of symptoms that, when considered together, will pinpoint the trouble.

Visual Inspection

In physically examining the Type 7A22, take special note of the area indicated by evaluation of symptoms. Look for loose or broken connections, improperly seated transistors and burned or otherwise damaged parts. Repair or replace all obviously defective components.

Calibration Check

Troubles can frequently be located and corrected by recalibrating the instrument. Unless the casualty has definitely been isolated to a specific circuit, it is recommended that the calibration procedure contained in Section 5 be performed to provide a logical circuit troubleshooting sequence.

DETAILED TROUBLESHOOTING

General

If the casualty has not been disclosed and corrected through the procedure outlined, a detailed troubleshooting

analysis will have to be performed. The Circuit Description Section, the Schematic Diagrams, and the troubleshooting aids contained in this section are designed to expedite troubleshooting.

The Circuit Description Section provides a fundamental understanding of circuit operation and is referred to the Schematic Diagrams. The Schematic Diagrams contain voltage and resistance values and signal waveforms. The specified operating conditions should be duplicated before making voltage or waveform comparisons.

NOTE

Voltages and waveforms may vary slightly between instruments. Those given in the schematics should be checked against each instrument while it is operating properly. Deviations should be noted on the schematics for later reference.

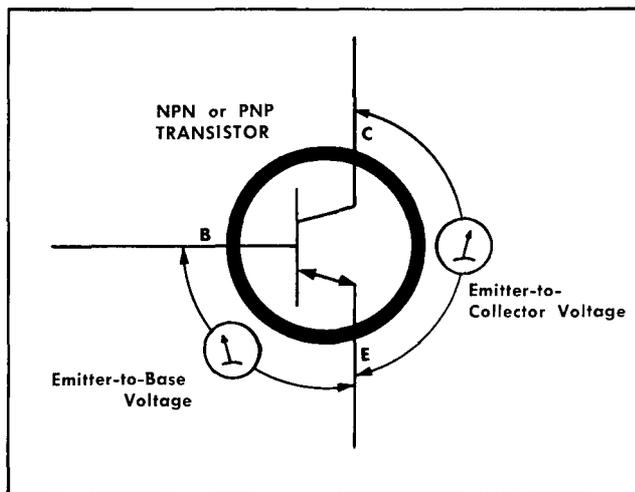

Fig. 4-2. Transistor junction-voltage measurements.

Test Equipment Recommended for Troubleshooting

The test equipment listed here should suffice for most troubleshooting jobs. Test equipment required for calibration is listed in the Calibration Section.

- High Impedance Voltmeter (20,000 Ω /V DC or greater)
- Ohmmeter (2 mA or less current on the $\times 1$ k Ω scale)
- Test Oscilloscope and Probes
- Flexible Plug-in Extension Cable
- Dynamic Transistor Tester

DC Balance Check

A properly operating oscilloscope will have its trace centered vertically on the CRT only when the Type 7A22 has a balanced output. The Type 7A22 is a balanced amplifier connected in a differential configuration, with the +INPUT circuit being electrically identical to the -INPUT circuit. With no signal or comparison voltage applied to the FET gates, any point in the +INPUT circuit should have a potential equal to an identical point in the -INPUT circuit.

If the CRT trace is deflected as a result of a Type 7A22 problem, unbalances will exist between the two circuits. The unbalance can be detected by connecting a high impedance voltmeter between identical points in the two circuits.

An aid to this process is to short together the inputs of the stage being checked as shown in this example.

Stage	Devices	Short Together
Signal Output	Q444, Q544	Q444, Q544 bases
Trigger Output	Q454, Q554	Q454, Q554 bases
Variable Stage	Q434, Q534	Q434, Q534 bases
Gain Switching Amplifier	Q404A, Q404B, Q414A, Q414B, Q424, Q524	Front ends of R401 and R501
Input Amplifier		AC-GND-DC switches to GND

If the output balance is checked first and is in error, work toward the front until an unbalance no longer exists. This localizes the trouble to the circuitry between the points which

are balanced and the points which are unbalanced. The individual components must then be checked.

Troubleshooting by Direct Replacement

Semi-conductor failures account for the majority of electronic equipment troubles. The ease of replacing transistors often makes substitution the most practical means of repair. If this method is used, these guide lines should be followed:

- Determine that the circuit is safe for the substitute component.
- Use only substitute components that are known to be good.
- Remove the plug-in from the oscilloscope before substituting components, to protect both you and the equipment.
- Be sure components are inserted properly.
- Check operation after each component is replaced.
- Return good components to their original sockets.
- Check calibration after a bad component has been replaced (see Table 4-1).

Component Checks

Transistors

The best means of checking a transistor is by using a transistor curve display instrument such as the Tektronix Type 576. If a transistor checker is not readily available, a defective transistor can be located by signal tracing, by making in-circuit voltage checks, by measuring the transistor resistances or by the substitution method previously described.

When troubleshooting using a voltmeter, measure the emitter-to-base and emitter-to-collector voltages to determine whether the voltages are consistent with normal circuit voltages. Voltages across a transistor vary with the device and its circuit function. Some of these voltages are predictable. The base-emitter voltage of a conducting germanium transistor will normally be approximately 0.2 V and that of a silicon transistor will normally be approximately 0.6 V. The col -

SECTION 5

PERFORMANCE CHECK/ CALIBRATION PROCEDURE

Introduction

Complete information for performing a Performance Check or Calibration of the Type 7A22 is contained in this section of the manual. The Equipment Required list is needed both for a Performance Check and for calibrating the Type 7A22. All waveform photographs, equipment setup pictures, and control settings apply whether the instrument is being calibrated or checked for performance.

To conduct a Performance Check complete all parts of each step in the following procedure, except the part subtitled ADJUST. To check the performance of the Type 7A22, it is not necessary to remove the oscilloscope side panel or make any internal adjustments. Adjustments located on the front panel of the Type 7A22 can be performed when checking the performance of the instrument. If the instrument does not meet the performance requirements given in this procedure, the complete procedure including adjustments should be done. All performance requirements given in this section correspond to the Specifications given in Section 1. For convenience in calibrating the Type 7A22, steps containing internal adjustments are marked with the symbol **ⓘ**.

Calibration of the Type 7A22 requires completion of all parts of each step in the following procedure. Completion of every step in this procedure returns the Type 7A22 to its original performance standards. To assure accurate measurements and correct operation, the calibration of the Type 7A22 should be checked after each 1000 hours of operation; or every six months if used infrequently. Before performing a complete calibration, thoroughly clean and inspect this instrument as outlined in the Maintenance section.

TEST EQUIPMENT REQUIRED

General

The following test equipment and accessories (or their equivalent) are required for a complete performance check or calibration of the Type 7A22. Specifications given are the minimum necessary for accurate performance of this instrument. All test equipment is assumed to be correctly calibrated and operating within the given specifications. If equipment is substituted, it must meet or exceed the specifications of the recommended equipment.

For the quickest and most accurate calibration or performance check, special Tektronix calibration fixtures are used where necessary. These special calibration fixtures are

available through your local Tektronix Field Office or representative.

1. 7000 Series Oscilloscope, referred to as "oscilloscope" in this procedure. For this procedure a Type 7504 with a 7B50 Time Base is used.

2. Constant Amplitude Sine-Wave Generator. Output frequency range of 10 Hz through 1.0 MHz; output amplitude range from 2 V to 20 V peak to peak. General Radio Type 1310A is recommended.

3. Standard Amplitude Calibrator. Amplitude accuracy, within 0.25%; signal amplitude 0.5 mV to 100 V; output signal 1 kHz square wave and DC. Tektronix Calibration Fixture 067-0502-01 recommended.

4. Reed Pulse Generator. Tektronix Calibration Fixture 067-0608-00 is recommended.

5. Coaxial Cable. Impedance, 50 ohms; length, 42 inches; connectors, BNC. Two required. Tektronix Part Number 012-0057-01.

6. Dual Input BNC connector. Provides matched signal paths to both Type 7A22 input connectors. Tektronix Part Number 067-0525-00.

7. Variable Attenuator. A variable attenuator which has the end terminals of a 100 ohm potentiometer connected from input to ground and the potentiometer divider arm connected to the attenuator output. Tektronix Calibration Fixture 067-0511-00 is recommended.

8. 1000:1 Divider. Tektronix Part Number 067-0529-00 is recommended.

9. Input RC Normalizer. RC time constant, 1 megohm \times 47 pF; connectors, BNC. Tektronix Part Number 067-0541-00 is recommended.

10. Attenuator. Impedance, 50 Ω ; Ratio, 10:1; connectors, BNC. Two each, Tektronix Part Number 011-0059-02.

11. Plug-in extender. Tektronix Calibration Fixture 067-0589-00.

12. Termination. Impedance, 50 Ω . Tektronix Part Number 011-0049-01.

13. BNC T Connector. Tektronix Part Number 103-0030-00.

14. Adapter, GR to BNC Female. Tektronix Part Number 017-0063-00.

15. Adapter, GR to BNC Male. Tektronix Part Number 017-0064-00.

16. Banana plug-jack to banana plug-jack patch cord. Tektronix Part Number 012-0031-00 (red) or 012-0034-00 (black). Three needed.

SHORT-FORM PERFORMANCE CHECK/CALIBRATION PROCEDURE

This short-form procedure is provided to aid in checking the performance or calibration of the Type 7A22. It may be used as a guide by the experienced operator or calibrator, or it may be reproduced and used as a permanent record of calibration. Since the step numbers and titles used here correspond to those used in the complete procedure, this procedure also serves as an index to locate a step in the complete procedure. Performance requirements listed here correspond to those given in Section 1.

Type 7A22, Serial No. _____

Calibration Date - - - - -

Calibrated By - - - - -

- 1. Check or Adjust AC Atten Bal (R505) Page 5-4
Trace within 1.5 Div of graticule center as VOLTS/DIV switch is changed from 10 mV to 20 μ V.
- 2. Check or Adjust Variable Bal (R425) Page 5-4
Maximum trace shift ± 0.2 Div as the VARIABLE (VOLTS/DIV) is rotated stop-to-stop.
- 3. Check or Adjust Coarse DC Bal (R275) Page 5-4
Trace within 0.1 Div of graticule center as LF -3 dB POINT selector is changed from 10 kHz to DC.
- 4. Check or Adjust + INPUT Zero (R115) Page 5-5
Maximum trace shift ± 2 Div as the + INPUT AC-GND-DC switch is switched from GND to AC.
- 5. Check or Adjust - INPUT Zero (R215) Page 5-5
Maximum trace shift ± 2 Div as the - INPUT AC-GND-DC switch is switched from GND to AC.
- 6. Check or Adjust GAIN (R540) Page 5-5
Correct vertical deflection in the 1 mV position of the VOLTS/DIV switch (front panel adjustment).
- 7. Check VARIABLE (VOLTS/DIV) control Page 5-5
Ratio
Display amplitude decreases by a ratio of 2.5:1 when the VARIABLE control (in the out position) is rotated fully counterclockwise.
- 8. Check VOLTS/DIV Gain Switching Page 5-5
Correct vertical deflection from 10 μ V through 10 mV.
- 9. Check Isolation Between + and - INPUTS Page 5-7
Trace deflection of 0.5 Div or less.
- 10. Check Total DC OFFSET Range Page 5-7
Check for minimum offset range of + and -1 volt.
- 11. Check or Adjust C241 - Cross Neutralization Page 5-7
With signal connected to + INPUT, switch the -

INPUT AC-GND-DC from GND to DC; aberration should not exceed $\pm 1\%$.

- 12. Check or Adjust C141 - Cross Neutralization Page 5-8
With signal connected to - INPUT, switch the + INPUT AC-GND-DC from GND to DC; aberration should not exceed $\pm 1\%$.
- 13. Check or Adjust C115 $\times 1$ + INPUT Page 5-8
Attenuator
Time Constant
Optimum square wave response
- 14. Check or Adjust C215 $\times 1$ - INPUT Page 5-8
Attenuator
Time Constant
Optimum square wave response.
- 15. Check Input Attenuator Accuracy Page 5-9
Correct vertical deflection from 10 mV through 10 V.
- 16. Check or Adjust Attenuator Differential Page 5-9
Balance (R108E, R109E, R110E)
Optimum differential balance.
- 17. Check or Adjust + Input Attenuator Page 5-10
Compensation
(C108C, C109C, C110C, C108A, C109A, C110A)
Optimum square wave response.
- 18. Check or Adjust - Input Attenuator Series Page 5-10
Compensation to match + Input (C208C, C209C, C210C) Best common-mode signal rejection (minimum spike amplitude).
- 19. Check or Adjust - Input Attenuator Shunt Page 5-11
Compensation (C208A, C209A, C210A)
Optimum flat bottom display.
- 20. Check or Adjust HF -3 dB POINT (C425) Page 5-12
HIGH FREQ -3 dB POINT bandwidth limit.
- 21. Check LF -3 dB POINT Page 5-12
LOW FREQ -3 dB POINT bandwidth limit.
- 22. Check or Adjust CMRR (C330) Page 5-13
CMRR must be equal to or better than the specified requirements at the verification points shown in Section 1, Fig. 1-2 of the manual.
- 23. Check OVERDRIVE Indicator Page 5-13
Indicator turns on at approximately 1 volt.
- 24. Check Differential Signal Range Range 5-14
No change in sine-wave amplitude when + or - 1 volt DC is applied.
- 25. Check Overall Noise Level Tangentially Page 5-15
Less than 16 μ V of displayed noise, measured tangentially.
- 26. Check Overdrive Recovery Page 5-15
10 μ s or less to recover to within 0.5% of zero level.

lector-emitter voltage will vary with the circuit and circuit conditions but it should always exceed 0.5 V. The best way of checking these devices is by connecting a voltmeter across the junction, using a sensitive voltmeter setting (see Fig. 4-2).

An ohmmeter can be used to check a transistor if the ohmmeter's voltage source and current are kept within safe limits. 1.5 V and 2 mA are generally acceptable. Selecting the $\times 1$ k Ω scale on most ohmmeters will provide voltage and current below these values.

Table 4-2 contains the normal values of resistance to expect when making an ohmmeter check of an otherwise unconnected transistor.

Fig. 4-3 shows the transistor base and socket arrangements used in this instrument.

TABLE 4-2

Transistor Resistance Checks

Ohmmeter ¹ Connections	Resistance Reading That Can be Expected Using the R $\times 1$ k Range
Emitter-Collector	High readings both ways
Emitter-Base	High reading one way, low reading the other way
Base-Collector	High reading one way, low reading the other way

¹Test prods from the ohmmeter are first connected to the transistor leads and then the test lead connections are reversed. Thus, the effects of the polarity reversal of the voltage applied from the ohmmeter to the transistor can be observed.

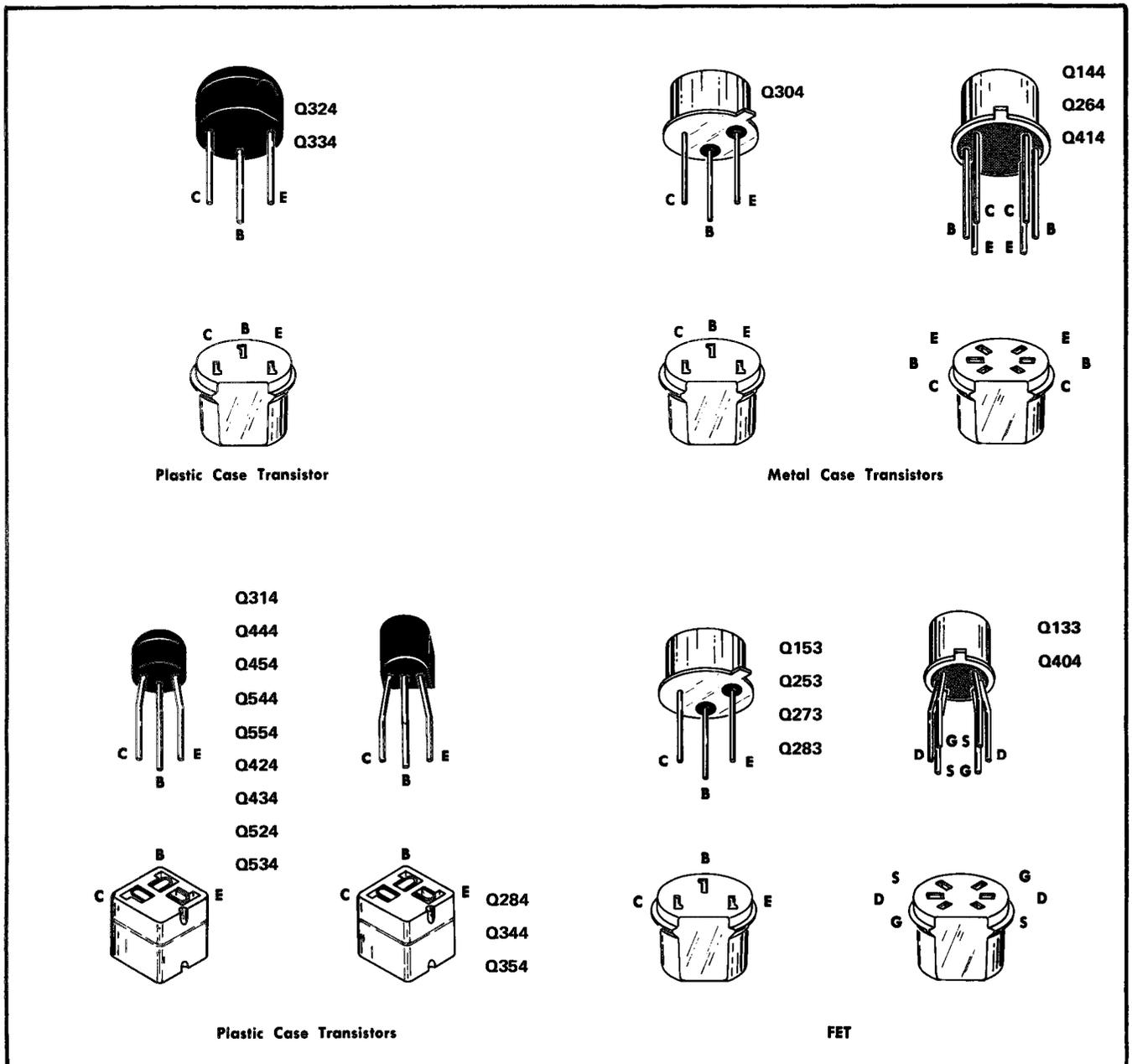

Fig. 4-3. Transistor base pin and socket arrangement.

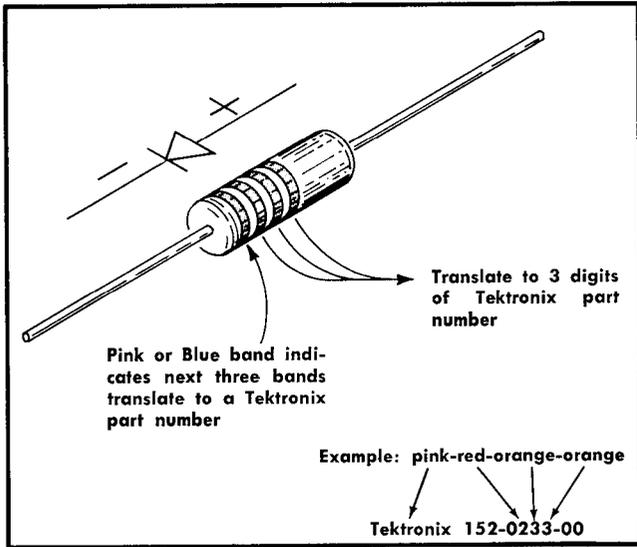

Fig. 4-4. Diode polarity and color code.

Diodes

A diode can be rechecked for an open or for a short circuit by measuring the resistance between terminals with an ohmmeter set to the R X 1 k scale. The diode resistance should be very high in one direction and very low when the meter leads are reversed. Do not check tunnel diodes or back diodes with an ohmmeter.

Some diodes used in the Type 7A22 are color coded to identify the diode type. The cathode end of each glass-encased diode is indicated by a stripe, a series of stripes or a dot. For most diodes with a series of stripes, the first stripe (either pink or blue) indicates a Tektronix part and the next three stripes indicate the three significant figures of the Tektronix Part Number. Example: a diode color coded blue-brown-gray-green indicates a diode with Tektronix Part No. 152-0185-00. The cathode and anode of a metal-encased diode can be identified by the diode symbol marked on the body. See Fig. 4-4, DIODE POLARITY AND COLOR CODES.

Resistors

The types and accuracies of resistors found in this instrument vary in accordance with the circuit needs. Replacement resistors should be of the same type and must be at least as accurate as those originally contained in the circuit, to maintain the high common-mode rejection ratio. The size, location and lead length are often critical because of frequency considerations.

Composition Resistors:

Metal-Film Resistors:

Ceramic Capacitors:

① ② and ③ —1st, 2nd and 3rd significant figures;
 (M) —multiplier; (T) —tolerance;
 (TC) —temperature coefficient.

Color	Significant Figures	Multiplier		Tolerance	
		Resistors	Capacitors	Resistors	Capacitors
Silver	---	10 ⁻²	---	±10%	---
Gold	---	10 ⁻¹	---	±5%	---
Black	0	1	1	---	±20% or 2 pF*
Brown	1	10	10	±1%	±1% or 0.1 pF*
Red	2	10 ²	10 ²	±2%	±2%
Orange	3	10 ³	10 ³	±3%	±3%
Yellow	4	10 ⁴	10 ⁴	±4%	+100% -0%
Green	5	10 ⁵	10 ⁵	±0.5%	±5% or 0.5 pF*
Blue	6	10 ⁶	10 ⁶	---	---
Violet	7	---	---	---	---
Gray	8	---	10 ⁻²	---	+80% -20% or 0.25 pF*
White	9	---	10 ⁻¹	---	±10% or 1 pF*
(none)	---	---	---	±20%	±10% or 1 pF*

*For capacitance of 10 pF or less.

NOTE: (T) and/or (TC) color code for capacitors depends upon manufacturer and capacitor type. May not be present in some cases.

Fig. 4-5. Color code for resistors and ceramic capacitors.

Composition, wire-wound and metal film resistors are used in this unit. The stable metal film resistors may be identified by their light blue or gray body color. If a metal film resistor has a value indicated by three significant figures and a multiplier, it will be color coded according to the EIA standard resistor color code. If it has a value of more than three significant figures and a multiplier, the value will be printed

Capacitors

A leaky or shorted capacitor can be detected by checking resistance with an ohmmeter using the highest scale that does not exceed the voltage rating of the capacitor. The resistance reading should be high after the initial charge of the capacitor. An open capacitor can be detected with a capacitance meter or by checking whether the capacitor passes AC signals.

The capacitance values of common disc capacitors and small electrolytics are marked in microfarads on the side of the component body. The white ceramic capacitors used in the Type 7A22 are color coded in picofarads using a modified EIA code (see Fig. 4-5).

Repackaging for Shipment

If the Tektronix instrument is to be shipped to a Tektronix Service Center for service or repair, attach a tag showing: owner (with address) and the name of an individual at your firm that can be contacted, complete instrument serial number and a description of the service required.

Save and re-use the package in which your instrument was shipped. If the original packaging is unfit for use or not available, repackage the instrument as follows:

Surround the instrument with polyethylene sheeting to protect the finish of the instrument. Obtain a carton of corrugated cardboard of the correct carton strength and having inside dimensions of no less than six inches more than the instrument dimensions. Cushion the instrument by tightly packing three inches of dunnage or urethane foam between carton and instrument, on all sides. Seal carton with shipping tape or industrial stapler.

The carton test strength for your instrument is 200 pounds.

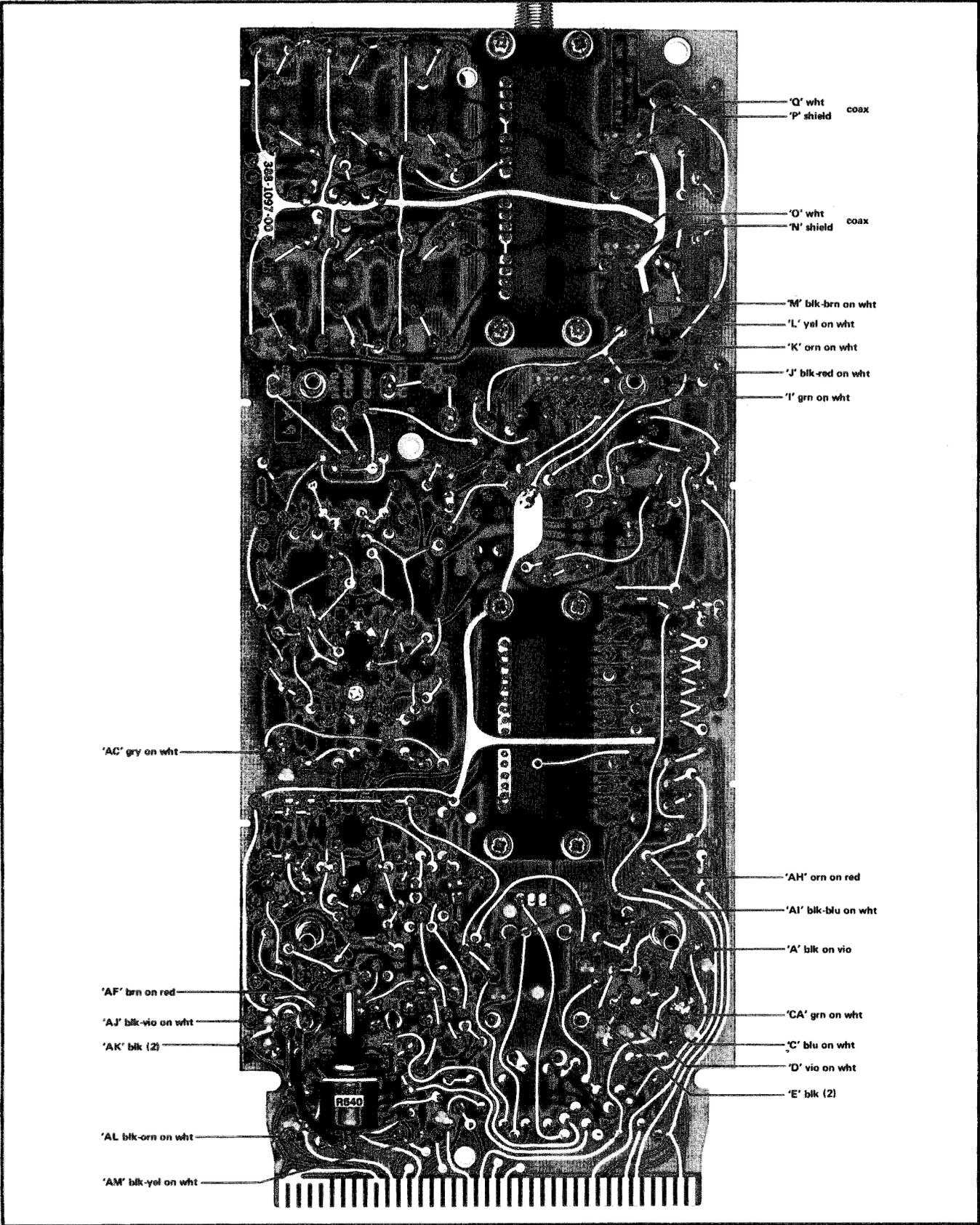

Fig. 4-7. Main circuit board (wire color code).

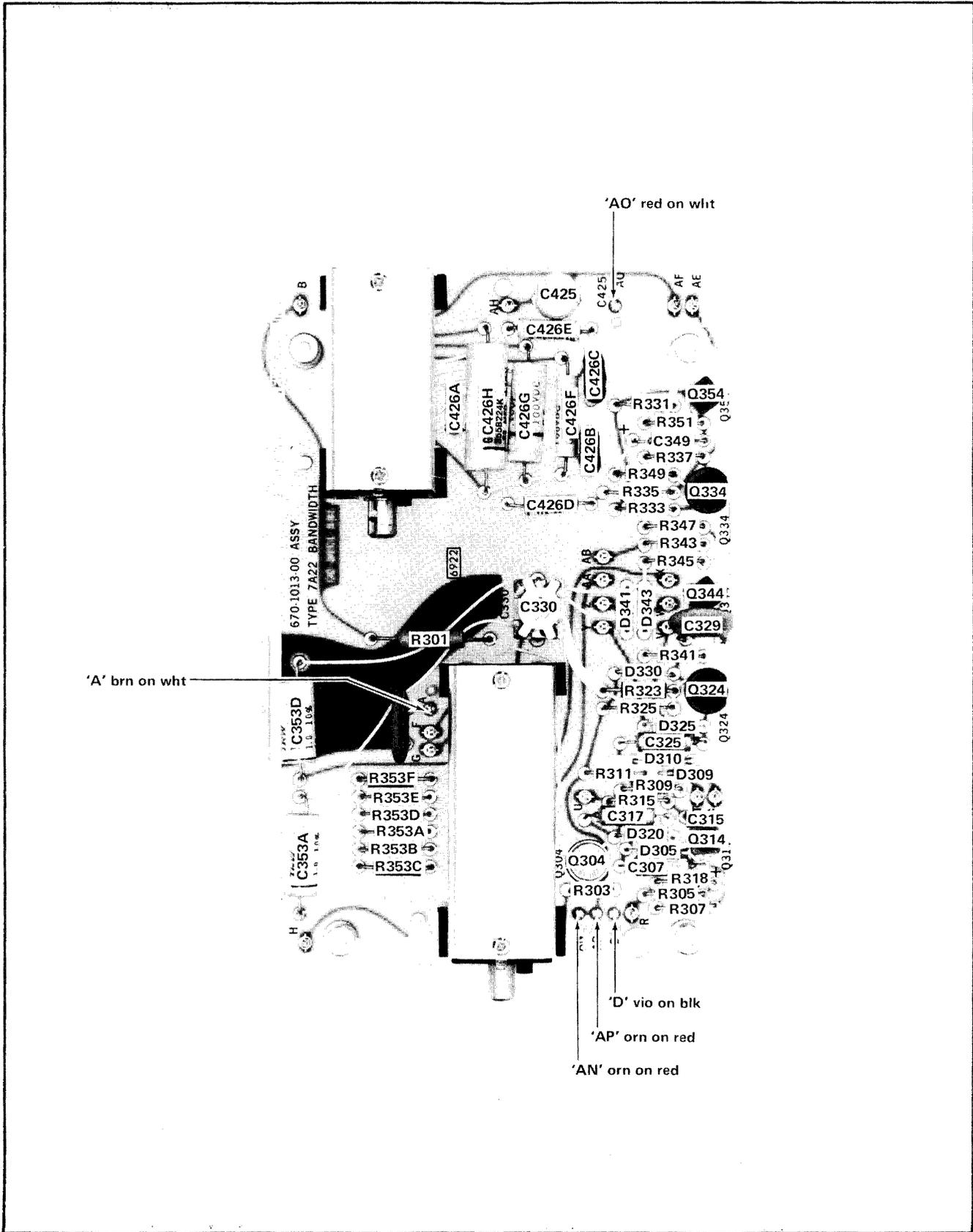

Fig. 4-8. Bandwidth circuit board (components and wire color code)

PERFORMANCE CHECK/CALIBRATION PROCEDURE

General

The following procedure is arranged in a sequence which allows the Type 7A22 to be calibrated with the least interaction of adjustments and reconnection of equipment. The steps in which adjustments are made are identified by the symbol following the title. Instrument performance is checked in the "CHECK" part of the step before an adjustment is made. The "ADJUST" part of the step identifies the point at which the actual adjustment is made. Steps listed in the "INTERACTION" part of the step may be affected by the adjustment just performed. This is particularly helpful when only a partial calibration procedure is performed.

NOTE

To prevent recalibration of other parts of the instrument when performing a partial calibration, readjust only if the tolerances given in the "CHECK" part of the step are not met. However, when performing a complete calibration, best overall performance is obtained if each adjustment is made to the exact setting even if the "CHECK" is within the allowable tolerance.

In the following procedure, a test-equipment setup picture is shown for each major group of checks and adjustments. Each step continues from the equipment setup preceding the desired portion. External controls or adjustments of the Type 7A22 referred to in this procedure are capitalized (e.g., POSITION). Internal adjustment names are initial capitalized only (e.g., Variable Bal).

All waveforms shown in this procedure are actual waveform photographs taken with a Tektronix Oscilloscope Camera System. The following procedure uses the equipment listed under Test Equipment Required. If equipment is substituted, control settings or test equipment setup may need to be altered to meet the requirements of the equipment used. Detailed operating instructions for the test equipment are not given in this procedure. If an doubt as to the correct operation of any of the test equipment, refer to the instruction manual for that unit.

NOTE

It is assumed that performance is checked within a temperature range of 0°C to +50°C and calibration + 25°C, ± 5°C; the tolerances given in this procedure are for this temperature range. However, if the procedure is performed at some other temperature, check the applicable tolerances for that temperature range.

Preliminary Procedure

1. If the Type 7A22 is to be calibrated, insert the plug-in extender into the oscilloscope and plug the Type 7A22 into the plug-in extender. If this procedure is a Performance Check only, insert the Type 7A22 into the oscilloscope plug-in compartment.
2. Connect the oscilloscope power cord to the design center operating voltage for which the oscilloscope is wired.
3. Turn on the oscilloscope POWER switch. Allow at least 20 minutes warmup for checking the instrument to the given accuracy.
4. Preset the Type 7A22 front panel controls as follows:

VOLTS/DIV	10 mV
VARIABLE	CAL IN
POSITION	Midrange
HIGH FREQ —3 dB POINT	100 Hz
LOW FREQ —3 dB POINT	10 kHz
AC-GND-DC (+ INPUT)	GND
AC-GND-DC (—INPUT)	GND
STEP ATTEN DC BAL	Midrange
DC OFFSET COARSE	5 turns from either extreme
DC OFFSET FINE	Midrange
5. Preset the Time Base front panel controls to these settings:

Time/Div	.5 ms
Variable	In (Calibrated)
Triggering	Auto, AC, Int
6. Set the oscilloscope Focus and Intensity for best viewing.

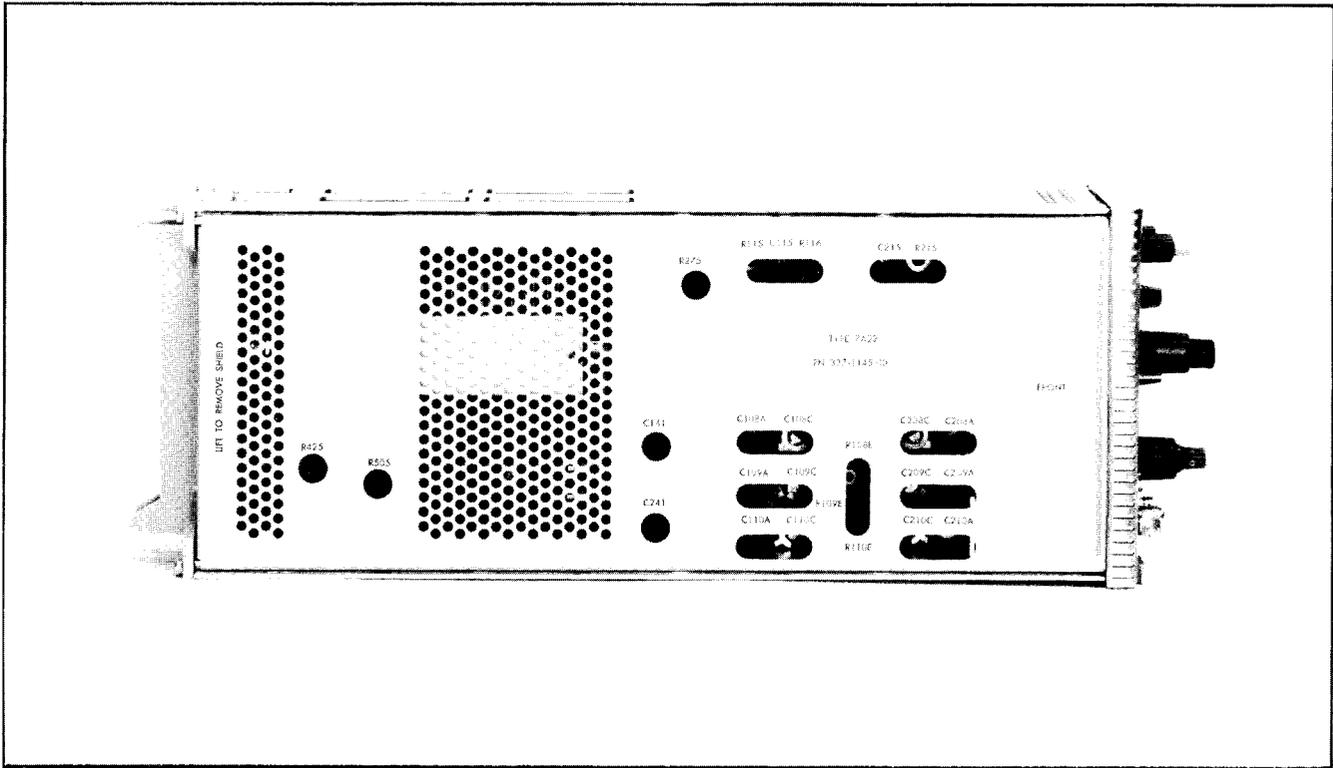

Fig. 5-1. Left side of the 7A22 showing adjustment locations.

NOTE

Calibration of the Type 7A22 must be performed with the side covers in place. All internal adjustments can be made using the access holes provided in the side covers.

1. Check or Adjust AC Step Atten Bal ①

- a. Center the trace on the CRT with the POSITION control.
- b. Rotate the VOLTS/DIV switch from 10 mV to the 20 μ V position.
- c. CHECK—The trace should remain within 1.5 div of graticule center.
- d. ADJUST—AC Step Atten Bal control, R505, (see Fig. 5-1) to position the trace within 1.5 div of graticule center.

2. Check or Adjust Variable Bal ①

- a. Set the Type 7A22 VOLTS/DIV switch to 10 mV.
- b. Position the trace to graticule center with the POSITION control.
- c. Rotate the VARIABLE VOLTS/DIV (in the out position) from stop to stop.
- d. CHECK—For maximum trace shift not to exceed ± 0.2 div while rotating the VARIABLE control throughout its range.

- e. ADJUST—Variable Bal control, R425, (see Fig. 5-1) for no trace shift while rotating the VARIABLE control.

3. Check or Adjust Coarse DC Bal ①

- a. Set the VARIABLE VOLTS/DIV to the CAL IN position.
- b. Position the LOW FREQ -3 dB POINT switch to the DC position.
- c. CHECK—The trace should be within 0.1 div of graticule center.
- d. ADJUST—Coarse DC Bal, R275, (see Fig. 5-1) to position the trace to graticule center.
- e. Set the VOLTS/DIV switch to 50 μ V.
- f. CHECK—The trace should be on screen.
- g. ADJUST—If the trace is not on screen, start at the position of the VOLTS/DIV switch where an on screen display is obtained and readjust the Coarse DC Bal, working down to the 50 μ V position so the end result is an on-screen trace at 50 μ V.

Type 7A22 Controls

VOLTS/DIV	10 μ V
VARIABLE	CAL IN
POSITION	Midrange
HIGH FREQ -3 dB POINT	100 Hz

AC-GND-DC (-INPUT) GND

AC-GND-DC (+ INPUT) DC
 AC-GND-DC (-INPUT) GND
 STEP ATTEN DC BAL Adjust for proper DC balance.

Time/Div .5 ms
 Variable (Time/Div) Cal
 Triggering Auto, AC, Int

4. Check or Adjust + Gate Current Zero ①

- b. Using the POSITION control, position the trace to graticule center.
- c. Set the +INPUT AC-GND-DC switch to AC.
- d. CHECK—For maximum trace shift within ± 2 div.
- e. ADJUST—The +Gate Current Zero control, R1 15, (see Fig. 5-1), to position the trace to graticule center.
- f. CHECK—(only if adjustment has been made). Switch the +INPUT AC-GND-DC switch to GND and back to AC. There should be no movement of the trace.
- g. Set the +INPUT AC-GND-DC switch to GND.

5. Check or Adjust - Gate Current Zero ①

- a. Remove the 50 Ω termination from the + INPUT and connect it to the -INPUT connector.
- b. Position the trace to graticule center with the POSITION control.
- c. Set the -INPUT AC-GND-DC switch to AC.
- d. CHECK—For maximum trace shift within ± 2 div.
- e. ADJUST—The -Gate Current Zero control, R215, (see Fig. 5-1), to return the trace to graticule center.
- f. CHECK—(only if adjustment has been made). Return the -INPUT AC-GND-DC switch to GND and back to AC. There should be no trace shift.
- g. Disconnect the 50 Ω termination.
- h. Set the -INPUT AC-GND-DC switch to GND.

Type 7A22 controls

VOLTS/DIV 1 mV
 VARIABLE CAL IN
 POSITION Midrange
 HIGH FREQ -3 dB POINT 1 MHz
 LOW FREQ -3 dB POINT DC

6. Check or Adjust GAIN ①

- a. Test equipment setup is shown in Fig. 5-2.
- b. Connect a 5 mV peak-to-peak square wave signal from a standard amplitude calibrator through a 1000:1 divider and a coaxial cable to the +INPUT connector.
- c. Set the 1000:1 divider to $\times 1$.
- d. Align the display with the graticule lines using the POSITION control.
- e. CHECK—The display for a vertical amplitude of exactly 5 div.
- f. ADJUST—The GAIN control (front panel adjustment R540) for exactly 5 div of display amplitude.

7. Check VARIABLE Control Ratio

- a. With the VARIABLE in the OUT position, rotate the control fully counterclockwise.
- b. CHECK—The display amplitude should be 2 div or less to meet the 2.5:1 ratio requirement.

8. Check VOLTS/DIV Gain Switching

- a. Set the HIGH FREQ -3 dB POINT switch to 3 kHz.
- b. Set the LOW FREQ -3 dB POINT switch to 1 Hz.
- c. Set the standard amplitude calibrator output to 10 mV.
- d. Using the VARIABLE VOLTS/DIV control, adjust the display amplitude to exactly 5 div.
- e. Set the Time Base Triggering Source to Line.
- f. Position the Time/ Div switch to .1 μ s
- g. Switch the 1000:1 divider to $\times 1000$.
- h. CHECK—The vertical deflection factor from 10 μ V through 50 μ V. Table 5-1 is provided as a guide.

TABLE 5-1

VOLTS/DIV switch position	Standard Amplitude Calibrator Output Amplitude	Divisions of Deflection	Accuracy
10 μ V	.1 V	5	$\pm 2\%$
20 μ V	.2 V	5	$\pm 2\%$
50 μ V	.5 V	5	$\pm 2\%$

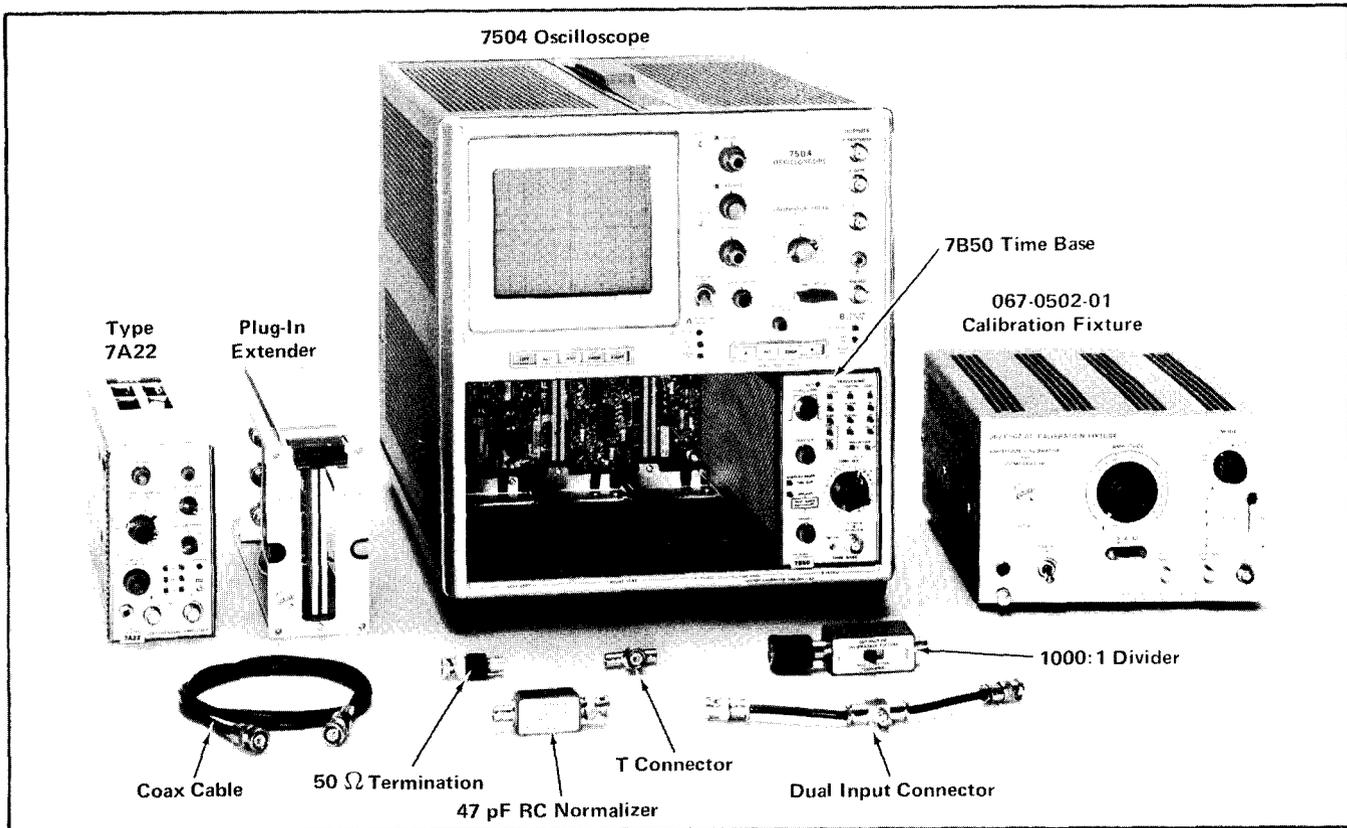

Fig. 5-2. Equipment required for steps 6 through 19..

- i. Return the VARIABLE to the CAL IN position.
- i. Switch the 1000:1 divider to the XI position.
- k. CHECK—The vertical deflection factor from .1 mV through 10 mV using Table 5-2 as a guide.

TABLE 5-2

VOLTS/DIV switch position	Standard Amplitude Calibrator Output Amplitude	Divisions of Deflection	Accuracy
.1 mV	.5 mV	5	± 2 %
.2 mV	1 mV	5	± 2 %
.5 mV	2 mV	4	± 2 %
1 mV	5 mV	5	± 2 %
2 mV	10mV	5	± 2 %
5 mV	20 mV	4	± 2 %
10mV	50 mV	5	± 2 %

1. Remove the 1000:1 divider from the Standard Amplitude Calibrator.

Type 7A22 Controls

VOLTS/DIV	1 mV
VARIABLE	CAL IN
POSITION	Midrange
HIGH FREQ -3 dB POINT	1 MHz
LOW FREQ -3 dB POINT	DC OFFSET
AC-GND-DC (+ INPUT)	DC
AC-GND-DC (-INPUT)	GND
STEP ATTEN DC BAL	Adjusted for DC balance

Time Base Controls

Time/Div	1 ms
Variable	Calibrated
Slope	+
Coupling	AC
Source	Int
Mode	Auto

9. Check Isolation Between + and -Inputs

- a. Set the Standard Amplitude Calibrator to .1 V square wave.
- b. Adjust the DC OFFSET COARSE and FINE controls to position the top of the square wave to the graticule center line.
- c. Switch the -AC-GND-DC switch to DC.
- d. CHECK—Trace deflection must be 0.5 division or less.
- e. Repeat the above procedure for the -INPUT, checking for trace deflection when switching the +AC-GND-DC switch to DC.

10. Check Total DC OFFSET Range

- a. Set the Type 7A22 controls as follows:

VOLTS/DIV	10 mV
AC-GND-DC (+INPUT)	DC
AC-GND-DC (-INPUT)	GND
- b. Set the Standard Amplitude Calibrator to 1 V and Mode selector to +DC.
- c. Connect a coaxial cable from the Standard Amplitude Calibrator output to the Type 7A22 + INPUT connector.
- d. Turn the COARSE and FINE OFFSET controls fully counterclockwise.
- e. CHECK—The trace can be returned to graticule center. (1 V minimum DC offset).
- i. Set the +INPUT AC-GND-DC switch to GND.
- j. Rotate the FINE and COARSE OFFSET controls clockwise to return the trace to graticule center (approximately 5 turns of the COARSE OFFSET control).

NOTE

The $\times 10$, $\times 100$, and $\times 1000$ input attenuators will be checked in step 15. Consequently, the remainder of the DC OFFSET ranges stated in Section 1 will be verified by that step.

Type 7A22 Controls

VOLTS/DIV	10 mV
VARIABLE POSITION	CAL IN
HIGH FREQ -3 dB POINT	Midrange
LOW FREQ -3 dB POINT	1 MHz
	DC
	DC
	GND
	Adjusted for proper balance

Time Base Controls

	.5 ms
	In
	Norm, +Slope, AC, Int

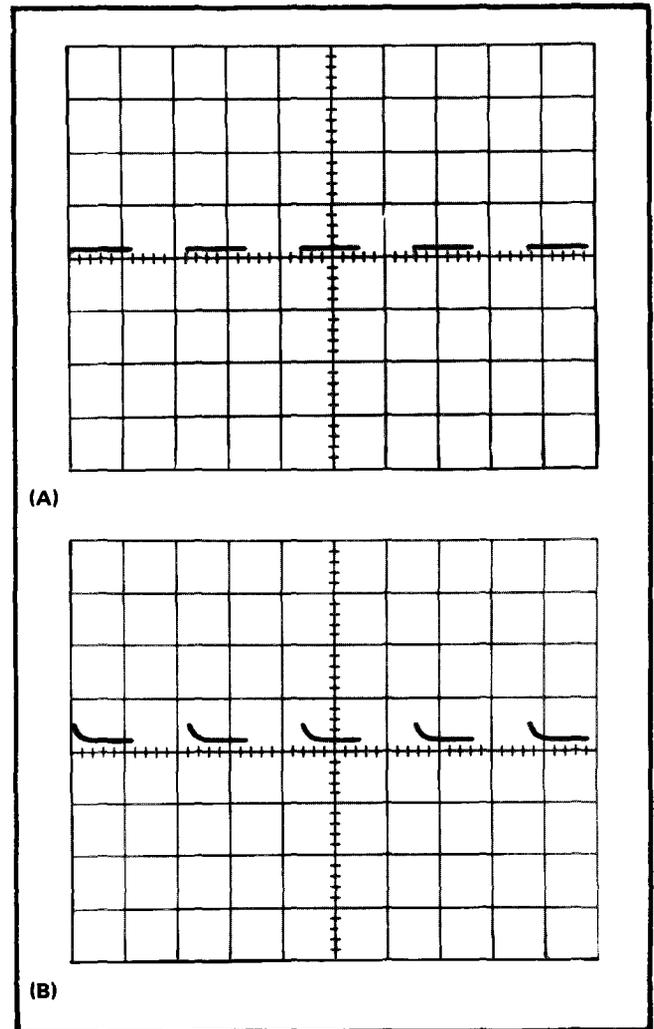

Fig. 5-3. Typical waveform showing (A) Cross neutralization properly adjusted, (B) incorrectly adjusted.

11. Check or Adjust C241 + Cross Neutralization

- a. Set the Standard Amplitude Calibrator for a 50 mV square-wave output.

NOTE

The Type 7A22 POSITION control and the Time Base horizontal positioning control may not always be mentioned. Use these controls as necessary to position the display for easy viewing.

- b. CHECK—The upper leading corner of the waveform, and note any aberration that occurs while switching the -INPUT AC-GND-DC switch from GND to DC. The waveform should appear similar to the one in Fig. 5-3. The aberration should not exceed $\pm 1\%$.

- c. Set the -INPUT AC-GND-DC switch to DC.
- d. ADJUST—C241 (see Fig. 5-1) for best square upper leading corner.

e. INTERACTION—C241 affects the $\times 1$ input capacitance and all other input attenuator adjustments. If C241 is adjusted out of sequence, steps 13, 14 and 16 through 18 must also be performed.

12. Check or Adjust C1 41 + Cross Neutralization

a. Disconnect the signal from the +INPUT connector and connect it to the -INPUT connector.

b. Set the +INPUT AC-GND-DC switch to GND.

c. CHECK—The lower leading corner of the second cycle of the display and note any aberration that occurs while switching the +INPUT AC-GND-DC switch from GND to DC. The bottom leading corner of the waveform should appear similar to the one shown in Fig. 5-3. The aberration should not exceed $\pm 1\%$.

d. Set the +INPUT AC-GND-DC switch to DC.

e. ADJUST—C1 41 (see Fig. 5-1) for best square corner.

f. INTERACTION—C141 affects the $\times 1$ input capacitance and all other input attenuator adjustments. If C141 is adjusted out of sequence, steps 13, 14 and 16 through 18 must be performed.

g. Disconnect the coaxial cable from the -INPUT.

13. Check or Adjust C1 15—x 1 +INPUT O Attenuator Time Constant

NOTE

It is important that C141 and C241 be properly adjusted before performing this adjustment. If you have not performed steps 11 and 12, do so at this point.

a. Connect a 47 pF input RC Normalizer to the +INPUT.

b. Connect a coaxial cable from the Standard Amplitude Calibrator to the RC Normalizer.

c. Set the -INPUT AC-GND-DC switch to GND.

d. Set the +INPUT AC-GND-DC switch to DC.

e. Set the Standard Amplitude Calibrator output to 0.1 V square wave.

f. CHECK—The square wave display for flat tops (see Fig. 5-4).

g. ADJUST—C1 15 (see Fig. 5-1) to obtain best square-wave response.

h. INTERACTION—If C1 15 is adjusted out of sequence, steps 14 and 16 through 19 must also be performed.

14. Check or Adjust C21 5—(x1 -INPUT O Attenuator Time Constant

a. Disconnect the RC Normalizer from the +INPUT and connect it to the -INPUT.

b. Set the +INPUT AC-GND-DC switch to GND.

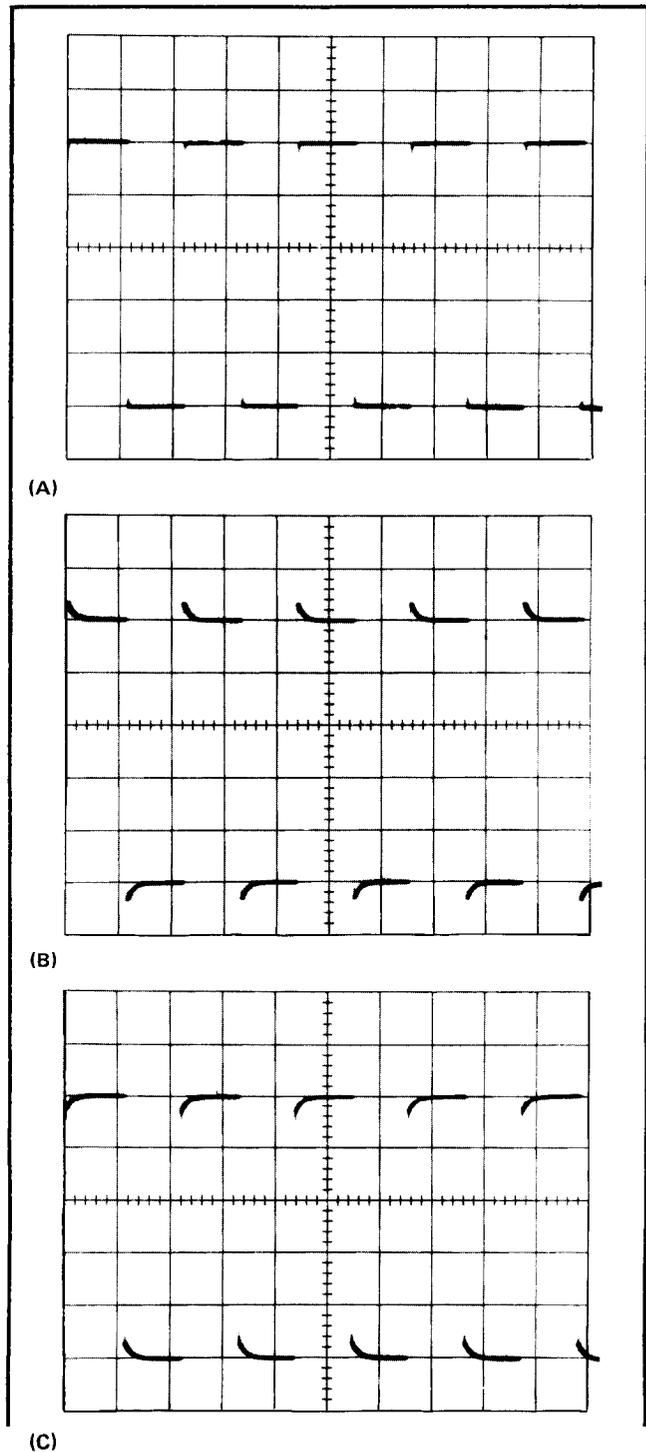

Fig. 5-4. Typical waveform showing (A) Correct adjustment of Input Attenuator Time Constant. (B) and (C) incorrect adjustment.

c. Set the -INPUT AC-GND-DC switch to DC.

d. CHECK—Each square wave for a flat bottom, using Fig. 5-4 as a guide.

e. ADJUST—C215 (see Fig. 5-1) for best flat bottom square-wave display, as in Fig. 5-4A.

f. INTERACTION—If C215 is adjusted out of sequence, steps 13 and 16 through 19 must also be performed.

g. Disconnect the signal and the RC Normalizer.

15. Check Input Attenuator Accuracy

a. Connect a 50 mV peak-to-peak square wave signal from the Standard Amplitude Calibrator through a coaxial cable to the +INPUT.

b. Set the +INPUT AC-GND-DC switch to DC.

c. CHECK—The input attenuators using Table 5-3 as a guide.

TABLE 5-3

VOLTS/DIV Switch Position	CALIBRATOR Output Peak to Peak	VERTICAL DEFLECTION (Accuracy ± 2%)
10 mV	50 mV	5 div ± .1 div
20 mV	.1 V	5 div ± .1 div
50 mV	.2 V	4 div ± .08 div
.1 V	.5 V	5 div ± .1 div
.2 V	1 V	5 div ± .1 div
.5 V	2 V	4 div ± .08 div
1 V	5 V	5 div ± .1 div
2 V	10 V	5 div ± .1 div
5 V	20 V	4 div ± .08 div
10 V	50 V	5 div ± .1 div

d. Disconnect the signal from the Type 7A22.

NOTE

(Applies to calibration only)

If there is a spike or fast rolloff of the leading corner of the square wave when checking from 20 mV to 10 V, ignore these, as they will be corrected in step 17.

16. Check or Adjust Input Attenuator Differential Balance

a. Connect a T connector to the Output connector of the Standard Amplitude Calibrator and a dual connector to the +INPUT and -INPUT connectors of the Type 7A22.

b. Connect a coaxial cable from the T connector to the dual input connector. Connect a coaxial cable from the T connector to the Ext In connector on the oscilloscope.

c. Set the Type 7A22 controls as follows:

VOLTS/DIV 50 mV
 AC-GND-DC (+INPUT) DC
 AC-GND-DC (-INPUT) DC

d. Set the oscilloscope Triggering Source switch to Ext.

e. Set the Standard Amplitude Calibrator output to 50 V.

f. CHECK—For optimum differential balance according to the information given in Table 5-4. When properly ad-

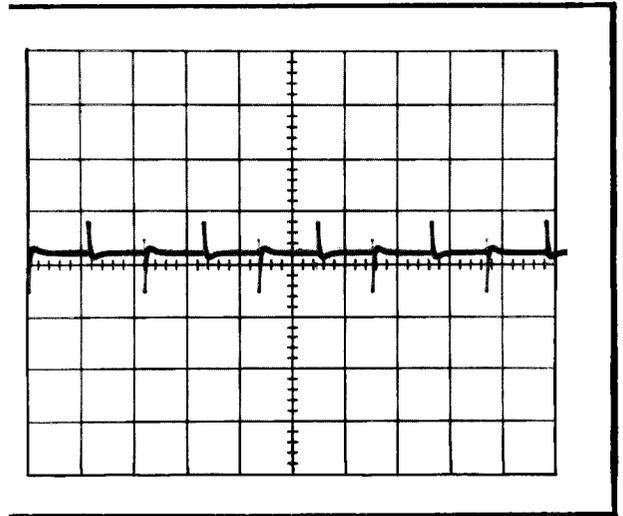

Fig. 5-5. Typical display obtained when Input Attenuators are adjusted for optimum differential balance.

justed, the waveform should appear as shown in Fig. 5-5. Disregard any spikes on the waveform.

g. ADJUST—R108E, R109E and R110E (see Fig. 5-1) for minimum amplitude as shown in Fig. 5-5, using Table 5-4 as a guide.

TABLE 5-4

VOLTS/DIV Switch Position	Calibrator Output (peak to peak)	Check and Adjust for Null	Input Attenuator
50 mV	50 V	Check/Adjust R108E	
20 mV	50 V	Check	× 10
.1 V	50 V	Check	
.5 V	100 V	Check/Adjust R109E	
.2 V	100 V	Check	× 100
1 V	100 V	Check	
5 V	100 V	Check/Adjust R110E	
2 V	100 V	Check	× 1000
10 V	100 V	Check	

h. Set the Standard Amplitude Calibrator for 0.2 V peak-to-peak output.

i. Disconnect the dual input connector from the Type 7A22.

Set the Type 7A22 Controls:

VOLTS/DIV 50 mV
 VARIABLE CAL IN
 HIGH FREQ -3 dB 1 MHz
 POINT
 LOW FREQ -3 dB DC
 POINT
 AC-GND-DC (+INPUT) DC
 AC-GND-DC (-INPUT) GND
 STEP ATTEN DC BAL Adjusted for proper DC Balance

Set the Time Base Controls.

Time/Div .5 ms
 Variable In (Cal)
 Triggering Auto, Ac, Int

17. Check or Adjust + Input Attenuator Compensation

a. Connect a 0.2 V peak-to-peak signal from the Standard Amplitude Calibrator through a coaxial cable to the +INPUT of the Type 7A22.

b. CHECK—The +INPUT Attenuator compensation for good square wave response.

c. ADJUST—The +INPUT Attenuator compensation for best square wave response using Table 5-5 as a guide. Fig. 5-1 shows the locations of the adjustments.

TABLE 5-5

Calibrator Output P-P	VOLTS/DIV Switch Position	Check/Adjust for Optimum		+ Input Attenuator
		Upper Leading Corner	Flat Top	
.2 V	50 mV	C108C		× 10
.1 V	20 mV	Check		
.5 V	.1 V	Check		
2 V	.5 V	C109C		× 100
1 V	.2 V	Check		
5 V	1 V	Check		
20 V	5 V	C110C		× 1000
10 V	2 V	Check		
50 V	10 V	Check		

Connect the 47 pF input RC normalizer between the + INPUT and the coaxial cable.

50 V	5 V		C110A	× 1000
20 V	2 V		Check	
100 V	10 V		Check	
5 V	.5 V		C109A	× 100
2 V	.2 V		Check	
10 V	1 V		Check	
.5 V	50 mV		C108A	× 10
.2 V	20 mV		Check	
1 V	.1 V		Check	

c. INTERACTION--If this step is performed out of sequence, steps 18 and 19 must be performed.

d. Disconnect the RC normalize, and coaxial cable from the Type 7A22 and the Standard Amplitude Calibrator.

18. Check or Adjust - Input Attenuator Series Compensation

e. Connect a T connector to the Standard Amplitude Calibrator output connector and a dual input connector to the

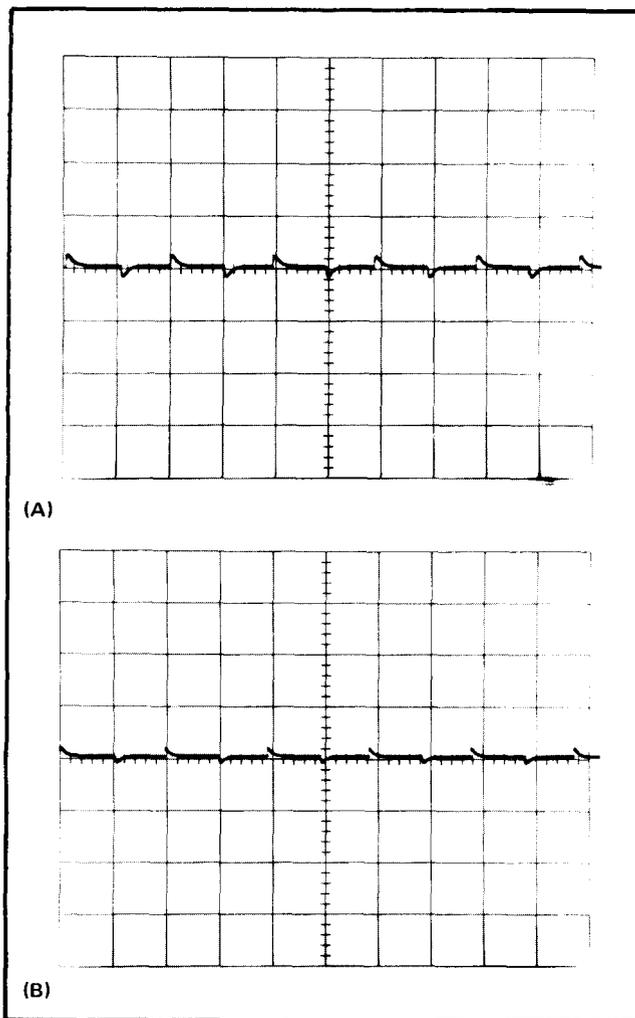

Fig. 5-6. Typical display obtained with - Input attenuator adjusted for optimum Common-Mode signal rejection. (A) C208C adjusted properly (B) C209C adjusted properly.

Type 7A22 +INPUT and -INPUT connectors. Connect a coaxial cable from the T connector to the dual input connector. Connect a coaxial cable from the T connector to the oscilloscope Ext In connector.

b. Set the oscilloscope Triggering Source switch to Ext.

c. Set the Standard Amplitude Calibrator output to 50 V square wave.

d. Set the Type 7A22 controls as follows:

VOLTS/DIV 50 mV
 AC-GND-DC (-INPUT) DC

e. CHECK—The displayed waveform for good common-mode signal rejection (minimum spike amplitude).

f. ADJUST—The - Input attenuator series compensation for best common-mode signal rejection (minimum spike amplitude) using the information given in Table 5-6. Fig. 5-6 illustrates the typical displays obtained and Fig. 5-1 shows the adjustment locations.

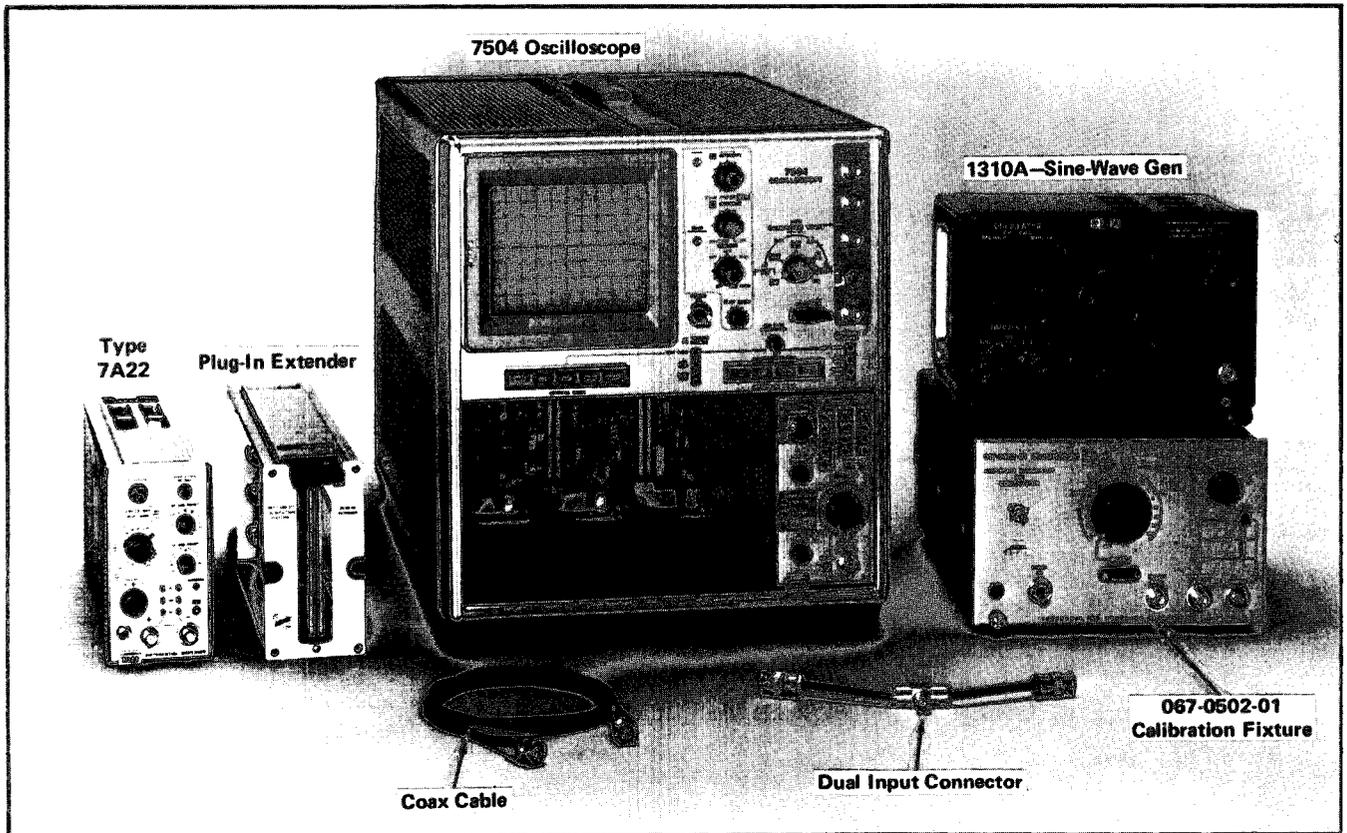

Fig. 5-7. Equipment required for steps 20 through 24.

TABLE 5-6

Calibrator Output P-P	VOLTS/DIV Switch Position	Check or Adjust for Min. Spike Amplitude	-Input Attenuator
50 Volts	50 mV	C208C	× 10
	20 mV	Check	
	.1 V	Check	
100 Volts	.5 V	C209C	× 100
	.2 V	Check	
	1 V	Check	
	5 V	C210C	× 1000
2 V	Check		
10 V	Check		

g. Disconnect all signal leads.

h. Return the oscilloscope Triggering Source switch to Int.

19. Check or Adjust -Input Attenuator O Shunt Compensation

a. Connect a 47 pF RC Normalizer to the -INPUT of the Type 7A22. Connect a coaxial cable from the Standard Amplitude Calibrator output connector to the RC Normalizer.

b. Set the Standard Amplitude Calibrator output to .5 V square wave.

c. Set the Type 7A22 controls as follows:

VOLTS/DIV 50 mV
AC-GND-DC (+- INPUT) GND

d. CHECK—Using Table 5-7 as a guide, check the display for a square wave response similar to the display illustrated in Fig. 5-4.

e. ADJUST—C208A, C209A, and C210A (see Fig. 5-1) for best flat bottom on the display, according to the information given in Table 5-7.

TABLE 5-7

Standard Amplitude Calibrator Output P-P	VOLTS/DIV Switch Position	Check or Adjust for Optimum Flat Bottom	-Input Attenuator
.5 Volt	50 mV	C208A	× 10
.2 Volt	20 mV	Check	
1 Volt	.1 V	Check	
5 Volts	.5 V	C209A	× 100
2 Volts	.2 V	Check	
10 Volts	1 V	Check	× 1000
50 Volts	5 V	C210A	
20 Volts	2 V	Check	
100 Volts	10 V	Check	

f. Disconnect the RC normalizer and all coaxial cables.

Type 7A22 controls:

POSITION	Midrange
VOLTS/DIV	1 V
VARIABLE	CAL IN
AC-GND-DC (+ INPUT)	GND
AC-GND-DC (- INPUT)	GND
LOW FREQ -3 dB POINT	DC
HIGH FREQ -3 dB POINT	1 MHz
STEP ATTEN DC BAL	Adjusted for DC balance

20. Check or Adjust HIGH FREQ -3dB POINT

- a. Test equipment setup is shown in Fig. 5-7.
- b. Set the Type 7A22 + INPUT AC-GND-DC switch to DC and use the oscilloscope controls as necessary for easy viewing of display.
- c. Connect a coaxial cable from the constant Amplitude Sine-Wave Generator to the Type 7A22 +INPUT.
- d. Set the output frequency of the Sine Wave Generator to 1 kHz and adjust for a 6 div display on the oscilloscope.
- e. Set the Sine Wave Generator output frequency to 1 MHz.
- f. CHECK—The amplitude of the oscilloscope display should be 4.2 div (this is the -3 dB point at 1 MHz). The 4.2 div display requirement must be met at 1 MHz + or - 10% (.9 MHz to 1.1 MHz).
- g. ADJUST—With the frequency set to 1 MHz, adjust C425 for 4.2 div of display amplitude. See Fig. 5-8 for location of adjustment.
- h. CHECK—The remaining positions of the HIGH FREQ -3 dB POINT selector in the same manner as in step h using Table 5-9 as a guide.

TABLE 5-9

Sine Wave Generator Output Frequency	HIGH FREQ -3 dB POINT Selector Position	Oscilloscope Display Amplitude	Bandwidth Tolerance $\pm 12\%$ of Input Freq
300 kHz	300 kHz	4.2 div	± 30 kHz
100 kHz	100 kHz	4.2 div	± 10 kHz
30 kHz	30 kHz	4.2 div	± 3 kHz
10 kHz	10 kHz	4.2 div	± 1 kHz
3 kHz	3 kHz	4.2 div	$\pm .3$ kHz
1 kHz	1 kHz	4.2 div	$\pm .1$ kHz
300 Hz	300 Hz	4.2 div	± 30 Hz
100 Hz	100 Hz	4.2 div	± 10 Hz

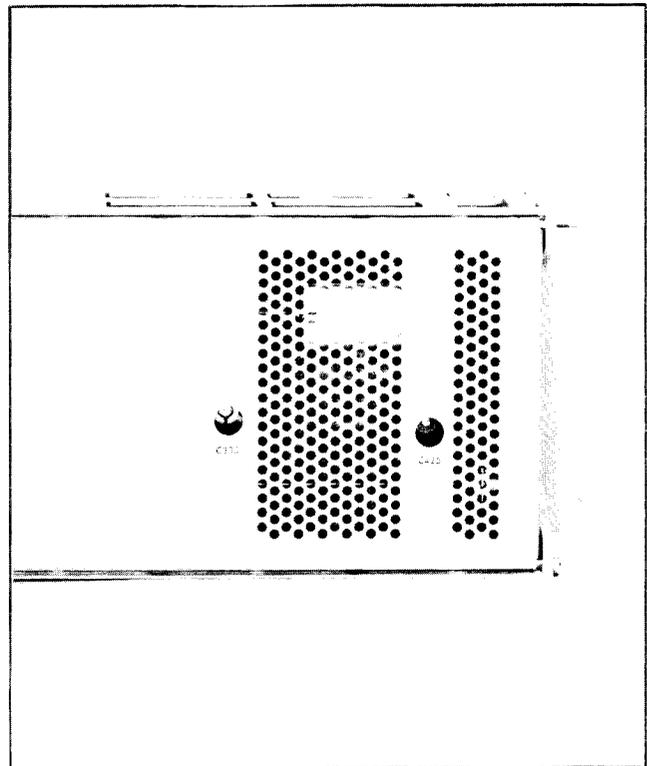

Fig. 5-8. Right side of Type 7A22 showing location of adjustments.

- i. Set the HIGH FREQ -3 dB POINT selector to 1 MHz.

21. Check LOW FREQ -3 dB POINT

- a. CHECK—Using Table 5-10 as a guide, check the LOW FREQ -3 dB POINT in the same manner that was used to check the HIGH FREQ -3 dB POINT.

TABLE 5-10

Sine Wave Generator Output Freq	LOW FREQ -3 dB POINT Selector Position	Oscilloscope Display Amplitude	Bandwidth Tolerance $\pm 12\%$ of Input Freq
10 Hz	10 Hz	4.2 div	± 1.2 Hz
100 Hz	100 Hz	4.2 div	± 12 Hz
1 kHz	1 kHz	4.2 div	± 120 Hz
10 kHz	10 kHz	4.2 div	± 1.2 kHz

NOTE

The components that are used in the 0.1 Hz and 1 Hz positions of the LOW FREQ -3 dB POINT selector are also used in the other positions of the selector; therefore, the tolerance of the 0.1 Hz and 1 Hz positions are checked.

NOTE

These adjustments interact, and a slight readjustment of C330 will be necessary after the cover is replaced over C144.

Type 7A22 controls:

VOLTS/DIV	5 V
VARIABLE	CAL IN
HIGH FREQ -3 dB POINT	1 MHz
LOW FREQ -3 dB POINT	DC
AC-GND-DC (+INPUT)	DC
AC-GND-DC (-INPUT)	GND
STEP ATTEN DC BAL	Adjusted for proper DC balance

Time-Base controls:

Time/Div	As necessary for easy viewing of display
Variable	In (Cal)
Triggering	Auto, AC, Ext

22. Check or Adjust Attenuator Common Mode Rejection 

a. Attach a BNC T connector to the 7B50 EXT in connector. Connect a coaxial cable from the Constant Amplitude Sine-Wave Generator output to the BNC T connector. Connect another coaxial cable from the BNC T connector to the dual input connector.

b. Connect the Dual-Input connector to the Type 7A22 + and - INPUTS.

c. Set the 7B50 SOURCE to EXT X10, and DISPLAY MODE to AMPLIFIER. Adjust the Constant Amplitude Sine-Wave Generator Level control for 20 V P-P at 100 kHz. Use the VARIABLE on the 7B50 to adjust for a suitable display of 4 to 6 horizontal divisions.

NOTE

The Sine-Wave Generator output must be maintained at a constant 20 V p-p for all of the CMRR checks.

d. Switch the Type 7A22 AC-GND-DC (+INPUT) to GND.

e. Switch the Type 7A22 VOLTS/DIV to .1 mV.

f. Simultaneously switch the Type 7A22 + and - AC-GND-DC switches to DC.

g. CHECK—The vertical deflection should not exceed 2 div. The 2 div requirement at 0.1mV/DIV is equivalent to a CMRR of 100,000:1 (2 div at .1 mV/DIV = .2 mV; 20 V ÷ .2 mV = 100,000).

h. Adjust C330 (and C144 SN B080000 and up) for minimum vertical deflection. See Fig. 5-8 for C330 location. C144 is under the plastic cover near Q153 on the left side of the 7A22 (see Fig. 4-6, page 4-10).

1. Set the Sine Wave Generator frequency to 100 kHz.
2. Set the Type 7A22 VOLTS/DIV to 20 mV.
3. Adjust—C108C for minimum vertical deflection.
4. ADJUST—R116 for minimum vertical deflection.

i. CHECK—Using Table 5-11 as a guide, check the CMRR at the remaining attenuator positions.

j. Disconnect all test leads and connectors.

Type 7A22 Controls:

VOLTS/DIV	10 mV
VARIABLE	CAL IN
POSITION	Midrange
HIGH FREQ -3 dB POINT	1 MHz
LOW FREQ -3 dB POINT	DC
AC-GND-DC (+INPUT)	GND
AC-GND-DC (-INPUT)	GND
STEP ATTEN DC BAL	Adjusted for DC balance

Time Base Controls:

Time/Div	1 ms
Triggering	+, Auto, AC, Int

23. Check Input OVERDRIVE Indicator

a. Connect a coaxial cable between the Sine-Wave Generator output and the Type 7A22 +INPUT.

b. Set the Sine-Wave Generator amplitude to minimum and frequency to 1 kHz.

c. Increase the Sine-Wave Generator amplitude until the Type 7A22 Input OVERDRIVE indicator lights.

d. CHECK—The sine-wave amplitude, peak to peak, and divide by 2 to find the + or - driving signal amplitude. The overdrive signal should be approximately 1 volt.

e. Disconnect coaxial cable from +Input.

Type 7A22 Controls:

VOLTS/DIV	1 mV
VARIABLE	CAL IN
POSITION	Midrange
HF -3 dB POINT	1 MHz
LF -3 dB POINT	10 Hz
AC-GND-DC (+INPUT)	GND

Sine-Wave Gen.		Type 7A22			
Amplitude	Frequency	VOLTS/DIV switch	+ and - INPUT switches	Vertical Deflection (max)	CMRR (min)
20 V p-p	100 kHz	1 mV	AC	1 div	20,000:1
	100 kHz	20 mV	AC	2.2 div	450:1
	100 kHz	20 mV	DC	2 div	500:1
	1 kHz	20 mV	DC	1 div	1,000:1
	1 kHz	20 mV	AC	1.1 div	900:1
	60 Hz	2 mV	AC	5 div	2,000:1

AC-GND-DC (-INPUT) GND
 STEP ATTEN DC BAL Adjusted for DC balance

Time Base Controls:

Time/Div 1 ms
 Variable Calibrated
 Slope +
 Coupling AC
 Source Int
 Mode Auto

b. Set the Standard Amplitude Calibrator amplitude to 1V, +DC.

c. Connect a coaxial cable between the Sine-Wave Generator output and the Type 7A22 -INPUT.

d. Switch the -AC-GND-DC switch to DC.

e. Adjust the Sine-Wave Generator amplitude control to give 5 div of 1 kHz display on the CRT graticule (if the Sine-Wave Generator minimum amplitude is too large, insert an attenuator between the coaxial cable and the -INPUT).

f. Switch the + AC-GND-DC switch to DC.

g. CHECK—Sine wave amplitude should not change when DC level from Standard Amplitude Calibrator is applied.

h. Switch the + AC-GND-DC switch to GND.

24. Check Differential Signal Range

a. Connect a coaxial cable between the Standard Amplitude Calibrator output connector and the Type 7A22 + INPUT.

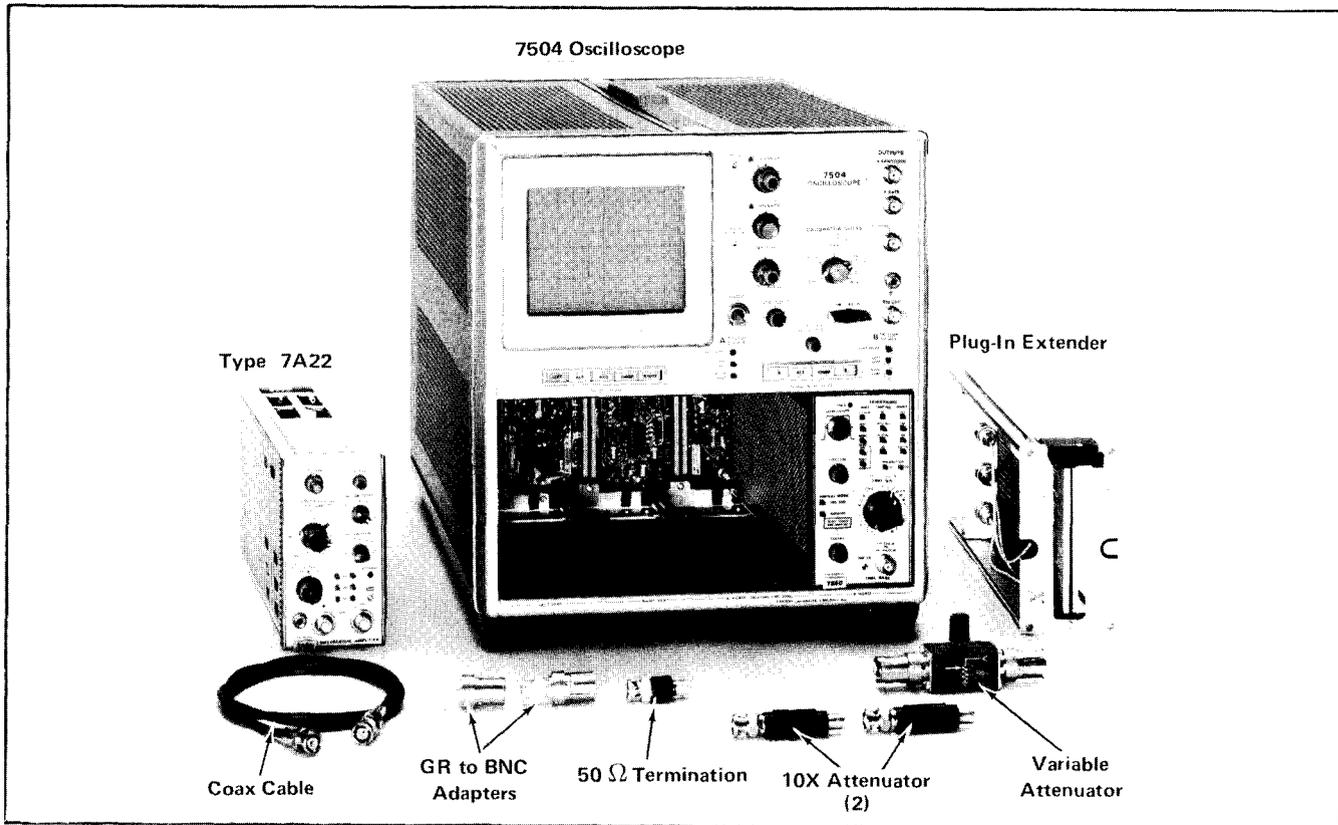

Fig. 5-9. Equipment required for step 25.

- i. Switch the Standard Amplitude Calibrator mode to -DC.
- j. Switch the + AC-GND-DC switch to DC.
- k. CHECK—Sine wave amplitude should not change when DC level from Standard Amplitude Calibrator is applied.
- l. Disconnect all test equipment and test leads.

25. Check Overall Noise Level Tangentially

- a. Equipment setup is shown in Fig. 5-9.
- b. Connect a 50 Ω termination to the +INPUT connector of the Type 7A22. Connect two 10× attenuators to the 50 Ω termination.
- c. Connect a GR to BNC adapter to the Oscilloscope Calibrator +Volts connector and connect the Variable Attenuator to the GR connector. Connect a GR to BNC adapter to the Variable Attenuator. Connect a coaxial cable from the 10× attenuators to the Variable Attenuator.
- d. Set the Oscilloscope Calibrator to 4 mV and 1 kHz.
- e. Set the 7A22 VOLTS/ DIV switch to 10 μV.
- f. Turn the Variable Attenuator fully clockwise.
- g. Set the Time Base Triggering Mode to Auto and Time/ Div to 10 μs.
- h. Turn the Variable Attenuator counterclockwise until the darker band between the two noise bands just disappears (see Fig. 5-10).
- i. Set the Type 7A22 VOLTS/DIV switch to 1 mV and the Time Base Time/Div switch to 1 ms.

- j. Remove the two 10× attenuators and connect the coaxial cable to the 50 Ω termination.
- k. Measure the square wave amplitude. Calculate the tangentially measured display noise as follows:

$$\frac{\text{square wave amplitude}}{100}$$

The tangentially measured noise should not exceed 16 μV.

Type 7A22 controls:

VOLTS/DIV	.2 V
VARIABLE (VOLTS/DIV)	CAL IN
POSITION	1 division below graticule center
HF -3 dB POINT	1 MHz
LF -3 dB POINT	DC
AC-GND-DC +INPUT	DC
AC-GND-DC -INPUT	GND
STEP ATTEN DC BAL	Adjusted for Dc Balance

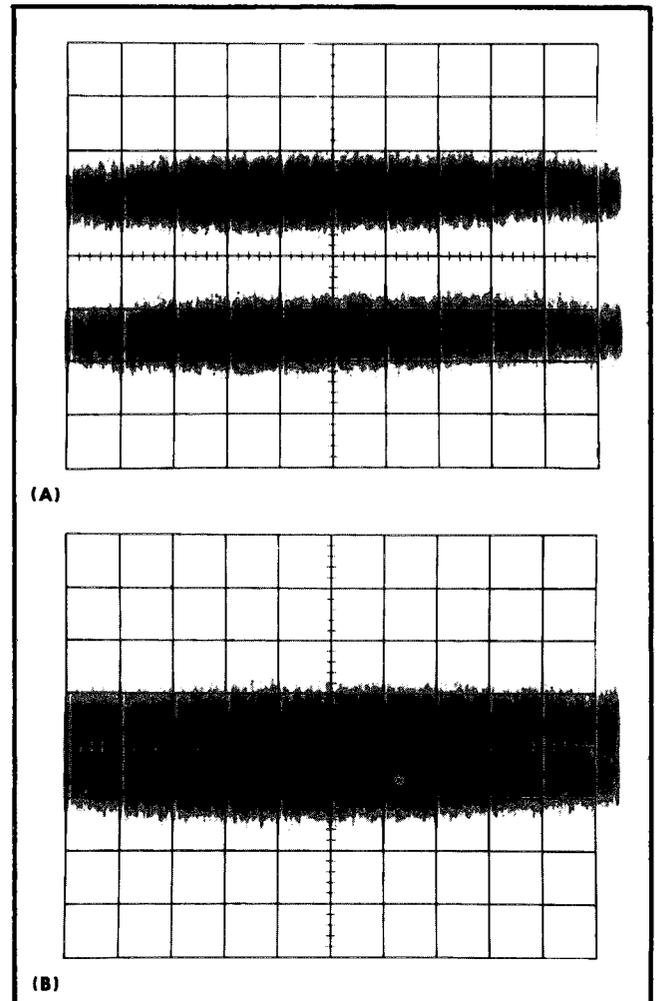

Fig. 5-10. Typical display showing (A) two noise bands and (B) merging noise bands,

Time Base controls:

Time/Div	2 μs
Variable	Cal In
Level/Slope	-
Coupling	DC
Source	Int
Mode	Auto

26. Check Overdrive Recovery Time

- a. Test equipment setup is shown in Fig. 5-11.
- b. Connect the Reed Pulse Generator Output to the Type 7A22 + INPUT.
- c. Connect the Reed Pulse Generator Power Cable to the Oscilloscope Probe Power connector (rear panel).
- d. Switch the Reed Pulse Generator Polarity switch to +.

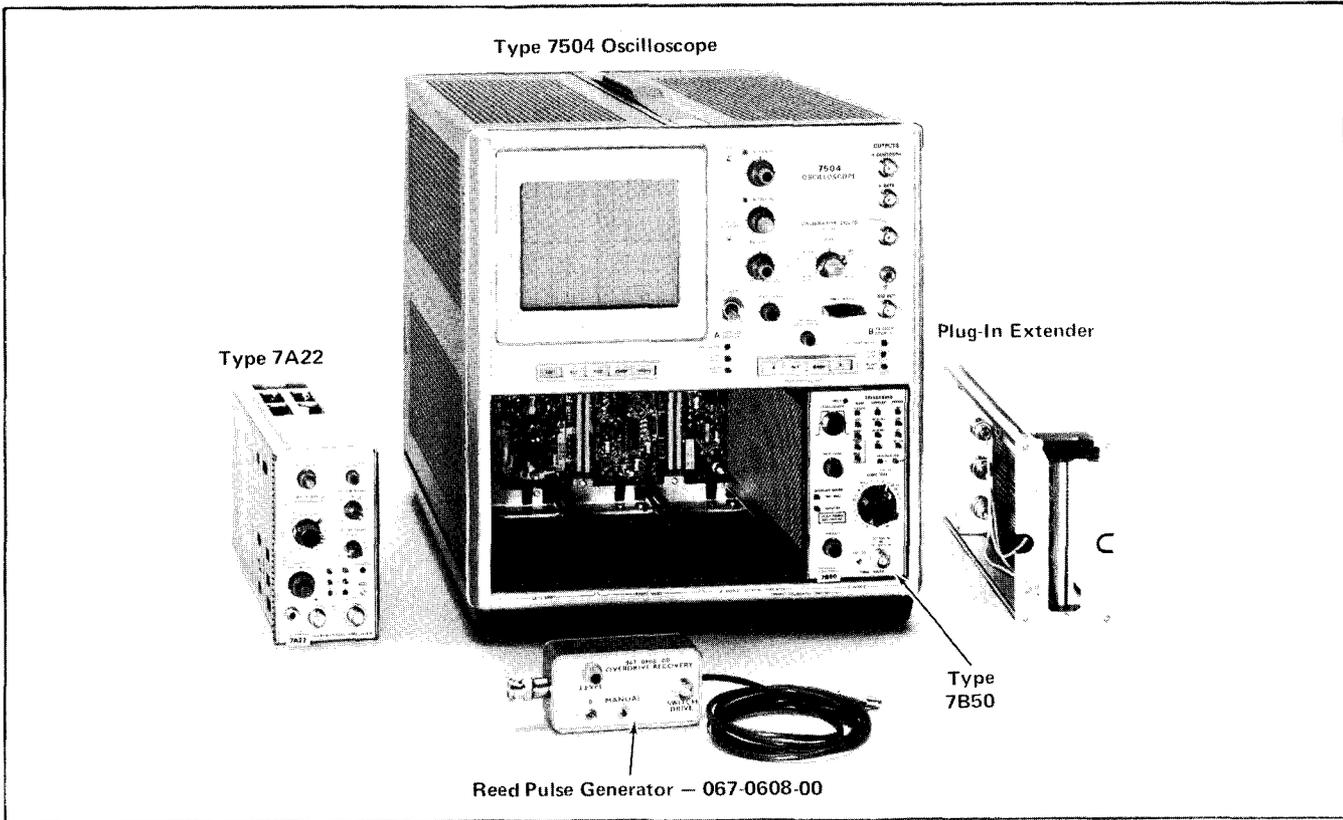

Fig. 5-11. Equipment required for step 26.

e. Hold down the Reed Pulse Generator Man switch and adjust the Level control to position the trace to the top graticule line (1 volt).

f. Release the Man switch and switch the Time Base Mode to Norm.

g. Set the Type 7A22 VOLTS/DIV switch to 1 mV.

h. Increase sweep Intensity to maximum (clockwise).

i. Depress the Reed Pulse Generator Man switch for 1 second.

j. CHECK—The waveform as the Reed Pulse Generator Man switch is released. Readjust the Time Base Level-Slope as necessary for proper triggering. The trace should return to within 5 mV of the reference (1 division below the graticule center) within 10 μ s (5 divisions). See Fig. 5-12 for photograph of typical recovery waveform.

k. Switch the Reed Pulse Generator Polarity switch to —.

l. Set the Time Base Level/Slope to +.

m. Decrease sweep Intensity for normal viewing.

n. Reset the Time Base Mode to Auto.

o. Position the trace (7A22 POSITION control) to 1 division above graticule center.

p. Reset the Time Base Mode to Norm.

q. Repeat parts h through i (waveform will be inverted from that in step i).

r. Connect Reed Pulse Generator Output to the 7A22 —INPUT and repeat above procedure.

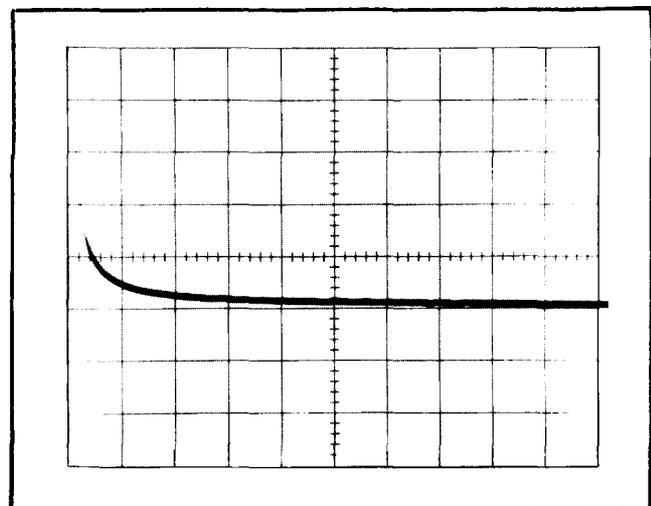

Fig. 5-12. Typical waveform showing overdrive recovery time.

REPLACEABLE ELECTRICAL PARTS

PARTS ORDERING INFORMATION

Replacement parts are available from or through your local Tektronix, Inc. Field Office or representative.

Changes to Tektronix instruments are sometimes made to accommodate improved components as they become available, and to give you the benefit of the latest circuit improvements developed in our engineering department. It is therefore important, when ordering parts, to include the following information in your order: Part number, instrument type or number, serial number, and modification number if applicable.

If a part you have ordered has been replaced with a new or improved part, your local Tektronix, Inc. Field Office or representative will contact you concerning any change in part number.

SPECIAL NOTES AND SYMBOLS

X000 Part first added at this serial number
00X Part removed after this serial number

ITEM NAME

In the Parts List, an Item Name is separated from the description by a colon (:). Because of space limitations, an Item Name may sometimes appear as incomplete. For further Item Name identification, the U.S. Federal Cataloging Handbook H6-1 can be utilized where possible.

ABBREVIATIONS

ACTR	ACTUATOR	PLSTC	PLASTIC
ASSY	ASSEMBLY	QTZ	QUARTZ
CAP	CAPACITOR	RECP	RECEPTACLE
CER	CERAMIC	RES	RESISTOR
CKT	CIRCUIT	RF	RADIO FREQUENCY
COMP	COMPOSITION	SEL	SELECTED
CONN	CONNECTOR	SEMICOND	SEMICONDUCTOR
ELECTLT	ELECTROLYTIC	SENS	SENSITIVE
ELEC	ELECTRICAL	VAR	VARIABLE
INCAND	INCANDESCENT	WW	WIREWOUND
LED	LIGHT EMITTING DIODE	XFMR	TRANSFORMER
NONWIR	NON WIREWOUND	XTAL	CRYSTAL

CROSS INDEX-MFR. CODE NUMBER TO MANUFACTURER

Mfr. Code	Manufacturer	Address	City, State, Zip
00853	SANGAMO ELECTRIC CO., S. CAROLINA DIV.	P O BOX 128	PICKENS, SC 29671
01002	GENERAL ELECTRIC COMPANY, INDUSTRIAL AND POWER CAPACITOR PRODUCTS DEPARTMENT	JOHN STREET	HUDSON FALLS, NY 12839
01121	ALLEN-BRADLEY COMPANY	1201 2ND STREET SOUTH	MILWAUKEE, WI 53204
02111	SPECTROL ELECTRONICS CORPORATION	17070 EAST GALE AVENUE	CITY OF INDUSTRY, CA 91745
03508	GENERAL ELECTRIC COMPANY, SEMI-CONDUCTOR PRODUCTS DEPARTMENT	ELECTRONICS PARK	SYRACUSE, NY 13201
04713	MOTOROLA, INC., SEMICONDUCTOR PROD. DIV.	5005 E MCDOWELL RD, PO BOX 20923	PHOENIX, AZ 85036
08806	GENERAL ELECTRIC CO., MINIATURE LAMP PRODUCTS DEPARTMENT	NELA PARK	CLEVELAND, OH 44112
11237	CTS KEENE, INC.	3230 RIVERSIDE AVE.	PASO ROBLES, CA 93446
12697	CLAROSTAT MFG. CO., INC.	LOWER WASHINGTON STREET	DOVER, NH 03820
15454	RODAN INDUSTRIES, INC.	2905 BLUE STAR ST.	ANAHEIM, CA 92806
15818	TELEDYNE SEMICONDUCTOR	1300 TERRA BELLA AVE.	MOUNTAIN VIEW, CA 94043
24931	SPECIALTY CONNECTOR CO., INC.	3560 MADISON AVE.	INDIANAPOLIS, IN 46227
27014	NATIONAL SEMICONDUCTOR CORP.	2900 SEMICONDUCTOR DR.	SANTA CLARA, CA 95051
32997	BOURNS, INC., TRIMPOT PRODUCTS DIV.	1200 COLUMBIA AVE.	RIVERSIDE, CA 92507
56289	SPRAGUE ELECTRIC CO.		NORTH ADAMS, MA 01247
71400	BUSSMAN MFG., DIVISION OF MCGRAW- EDISON CO.	2536 W. UNIVERSITY ST.	ST. LOUIS, MO 63107
71744	CHICAGO MINIATURE LAMP WORKS	4433 RAVENSWOOD AVE.	CHICAGO, IL 60640
72982	ERIE TECHNOLOGICAL PRODUCTS, INC.	644 W. 12TH ST.	ERIE, PA 16512
73138	BECKMAN INSTRUMENTS, INC., HELIPOT DIV.	2500 HARBOR BLVD.	FULLERTON, CA 92634
74970	JOHNSON, E. F., CO.	299 10TH AVE. S. W.	WASECA, MN 56093
75042	TRW ELECTRONIC COMPONENTS, IRC FIXED RESISTORS, PHILADELPHIA DIVISION	401 N. BROAD ST.	PHILADELPHIA, PA 19108
80009	TEKTRONIX, INC.	P O BOX 500	BEAVERTON, OR 97077
80294	BOURNS, INC., INSTRUMENT DIV.	6135 MAGNOLIA AVE.	RIVERSIDE, CA 92506
80740	BECKMAN INSTRUMENTS, INC.	2500 HARBOR BLVD.	FULLERTON, CA 92634
81483	INTERNATIONAL RECTIFIER CORP.	9220 SUNSET BLVD.	LOS ANGELES, CA 90069
87034	ILLUMINATED PRODUCTS INC., A SUB OF OAK INDUSTRIES, INC.	2620 SUSAN ST, PO BOX 11930	SANTA ANA, CA 92711
91637	DALE ELECTRONICS, INC.	P. O. BOX 609	COLUMBUS, NE 68601

Ckt No.	Tektronix		No. Dscont	Name & Description	Mfr	
	Part No.	Serial/Model Eff			Code	Mfr Part Number
	670-1013-00			CKT BOARD ASSY: BANDWIDTH	80009	670-1013-00
	670-1014-00	B010100	B029999	CKT BOARD ASSY: MAIN	80009	670-1014-00
	670-1014-01	B030000	B059999	CKT BOARD ASSY: MAIN	80009	670-1014-01
	670-1014-03	B060000	B069999	CKT BOARD ASSY: MAIN	80009	670-1014-03
	670-1014-04	B070000	B079999	CKT BOARD ASSY: MAIN	80009	670-1014-04
	670-1014-05	B080000	B115479	CKT BOARD ASSY: MAIN	80009	670-1014-05
	670-1014-06	B115480		CKT BOARD ASSY: MAIN	80009	670-1014-06
	670-1050-00	B010100	B059999	CKT BOARD ASSY: AC-GND-DC	80009	670-1050-00
	670-1050-01	B060000		CKT BOARD ASSY: AC-GND-DC	80009	670-1050-01
	670-1051-00	B010100	B059999	CKT BOARD ASSY: +AC-GND-DC	80009	670-1051-00
	670-1051-01			CKT BOARD ASSY: +AC-GND-DC	80009	670-1051-01
C1011	295-0117-00			CAP. ,SET,MTCHD:(2) 0.1UF,MATCHED 0.1%	80009	295-0117-00
C103	283-0636-00			CAP. ,FXD,MICA D:36PF,1.4%,100V	00853	D155F360G0
C108A	281-0092-00	B010100	B059999	CAP. ,VAR,CER DI:9-35PF,200V	72982	538-011 D9-35
C108A	281-0131-00	B060000		CAP. ,VAR,AIR DI:2.4-24.5PF,250V	74970	189-509-5
C108C	281-0131-00			CAP. ,VAR,AIR DI:2.4-24.5PF,250V	74970	189-509-5
C108D	283-0638-00			CAP. ,FXD,MICA D:130PF,1%,100V	00853	D151F131F0
C109A	281-0092-00	B010100	B059999	CAP. ,VAR,CER DI:9-35PF,200V	72982	538-011 D9-35
C109A	281-0131-00	B060000		CAP. ,VAR,AIR DI:2.4-24.5PF,250V	74970	189-509-5
C109C	281-0081-00			CAP. ,VAR,AIR DI:1.8-13PF,375VDC	74970	189-6-5
C109D	283-0594-00			CAP. ,FXD,MICA D:0.001UF,1%,100V	00853	D151F102F0
C110A	281-0092-00	B010100	B059999	CAP. ,VAR,CER DI:9-35PF,200V	72982	538-011 D9-35
C110A	281-0131-00	B060000		CAP. ,VAR,AIR DI:2.4-24.5PF,250V	74970	189-509-5
C110C	281-0079-00			CAP. ,VAR,AIR DI:1.5-9.1PF,800V	74970	189-4-5
C110D	283-0617-00			CAP. ,FXD,MICA D:4700PF,10%,300V	00853	D193F472K0
C115	281-0092-00	B010100	B059999	CAP. ,VAR,CER DI:9-35PF,200V	72982	538-011 D9-35
C115	281-0131-00	B060000		CAP. ,VAR,AIR DI:2.4-24.5PF,250V	74970	189-509-5
C141	281-0093-00			CAP. ,VAR,CER DI:5.5-18PF	72982	538-011A5.5-18
C144	281-0544-00	B010100	B079999	CAP. ,FXD,CER DI:5.6PF,10%,500V	72982	301-000COH0569D
C144	281-0122-00	B080000		CAP. ,VAR,CER DI:2.5-9PF,100V	72982	518-000A2.5-9
C156	283-0594-00			CAP. ,FXD,MICA D:0.001UF,1%,100V	00853	D151F102F0
C201 ¹	295-0117-00			CAP. ,SET,MTCHD:(2) 0.1UF, MATCHED 0.1%	80009	295-0117-00
C203	283-0636-00			CAP. ,FXD,MICA D:36PF,1.4%,100V	00853	D155F360G0
C208A	281-0092-00	B010100	B059999	CAP. ,VAR,CER DI:9-35PF,200V	72982	538-011 D9-35
	281-0131-00	B060000		CAP. ,VAR,AIR DI:2.4-24.5PF,250V	74970	189-509-5
	281-0131-00			CAP. ,VAR,AIR DI:2.4-24.5PF,250V	74970	189-509-5
C208D	283-0638-00			CAP. ,FXD,MICA D:130PF,1%,100V	00853	D151F131F0
C209A	281-0092-00	B010100	B059999	CAP. ,VAR,CER DI:9-35PF,200V	72982	538-011 D9-35
C209A	281-0131-00	B060000		CAP. ,VAR,AIR DI:2.4-24.5PF,250V	74970	189-509-5
C209C	281-0081-00			CAP. ,VAR,AIR DI:1.8-13PF,375VDC	74970	189-6-5
C209D	283-0594-00			CAP. ,FXD,MICA D:0.001UF,1%,100V	00853	D151F102F0
C210A	281-0092-00	B010100	B059999	CAP. ,VAR,CER DI:9-35PF,200V	72982	538-011 D9-35
C210A	281-0131-00	B060000		CAP. ,VAR,AIR DI:2.4-24.5PF,250V	74970	189-509-5
C210C	281-0079-00			CAP. ,VAR,AIR DI:1.5-9.1PF,800V	74970	189-4-5
C210D	283-0617-00			CAP. ,FXD,MICA D:4700PF,10%,300V	00853	D193F472K0
C215	281-0092-00	B010100	B059999	CAP. ,VAR,CER DI:9-35PF,200V	72982	538-011 D9-35
C215	281-0131-00	B060000		CAP. ,VAR,AIR DI:2.4-24.5PF,250V	74970	189-509-5
C241	281-0093-00			CAP. ,VAR,CER DI:5.5-18PF	72982	538-011A5.5-18
C244	281-0544-00			CAP. ,FXD,CER DI:5.6PF,10%,500V	72982	301-000COH0569D
C256	283-0594-00			CAP. ,FXD,MICA D:0.001UF,1%,100V	00853	D151F102F0
C264	283-0059-00			CAP. ,FXD,CER DI:1UF,+80-20%,25V	72982	8141N037Z5U0105Z
C283	290-0284-00			CAP. ,FXD,ELCTLT:4.7UF,10%,35V	56289	150D475X9035B2

Ckt No.	Tektronix Part No.	Serial/ Model No. Eff	Model No. Dscont	Name & Description	Mfr Code	Mfr Part Number
C307	290-0297-00			CAP.,FXD,ELCTLT:39UF,10%,10V	56289	15 0D396X9010B2
C315	281-0613-00			CAP.,FXD,CER DI:10PF,+/-1PF,200V	72982	374-001COG0100F
C317	290-0297-00			CAP.,FXD,ELCTLT:39UF,10%,10V	56289	15 0D396X9010B2
C325	290-0297-00			CAP.,FXD,ELCTLT:39UF,10%,10V	56289	150D396X9010B2
C329	283-0002-00			CAP.,FXD,CER DI:0.01UF,+80-20%,500V	72982	811-546E103Z
C330	281-0114-00			CAP.,VAR,AIR DI:1.3-5.4PF,750V	74970	189-0352-075
C349	290-0177-00			CAP.,FXD,ELCTLT:1UF,20%,50V	56289	162 D105X0050CD2
C353A	285-0809-00			CAP.,FXD,PLSTC:1UF,10%,50V	56289	LP66A1A105K
C353D	285-0809-00			CAP.,FXD,PLSTC:1UF,10%,50V	56289	LP66A1A105K
C353G	283-0058-00			CAP.,FXD,CER DI:0.027UF,10%,100V	72982	8131N147X7R0273K
C413	281-0534-00			CAP.,FXD,CER DI:3.3PF,+/-0.25PF,500V	72982	301-000C0J0339C
C425	281-0093-00			CAP.,VAR,CER DI:5.5-18PF	72982	538-011A5.5-18
C426A	281-0528-00			CAP.,FXD,CER DI:82PF,+/-8.2PF,500V	72982	301-000U2M0820K
C4:	283-0594-			C.P.,FXD,PLSTC:0.001UF,1%,10V	56:	D151F10:
C4:	285-0627-			C.P.,FXD,PLSTC:0.0033UF,5%,10V	56:	410P33:
C4:	285-0598-			C.P.,FXD,PLSTC:0.01UF,5%,10V	01:	61F10AC:
C4:	285-0702-			C.P.,FXD,PLSTC:0.033UF,5%,10V	56:	410P33:
C4:	285-0703-			C.P.,FXD,PLSTC:0.1UF,5%,10V	56:	410P10:
C4:	285-0633-			C.P.,FXD,PLSTC:0.22UF,20%,10V	56:	410P22:
C:	283-0000-			C.P.,FXD,CER DI:0.001UF,+100-0%,50V	72:	831-516E1:
C:	283-0092-			C.P.,FXD,CER DI:0.03UF,+80-20%,20V	72:	845-534E3:
C:	283-0111-			C.P.,FXD,CER DI:0.1UF,20%,10V	72:	81121-N088Z5U1:
C:	281-0534-			C.P.,FXD,CER DI:3.3PF,+/-0.25PF,50V	72:	301-000C0J03:
C:	283-0000-			C.P.,FXD,CER DI:0.001UF,+100-0%,50V	72:	831-516E1:
C:	283-0059-			C.P.,FXD,CER DI:1UF,+80-20%,10V	72:	8141N037Z5U01:
C:	283-0134-			C.P.,FXD,CER DI:0.47UF,+80-20%,10V	72:	8141N077Z5U04:
C:	283-0080-			C.P.,FXD,CER DI:0.022UF,+80-20%,10V	56:	19C:
C:	283-0080-			C.P.,FXD,CER DI:0.022UF,+80-20%,10V	56:	19C:
C:	283-0080-			C.P.,FXD,CER DI:0.022UF,+80-20%,10V	56:	19C:
CR:	152-0323-			SEMICONDUCTOR DEVICE:SILICON,35V,0.15A	80:	152-0323-
CR:	152-0323-			SEMICONDUCTOR DEVICE:SILICON,35V,0.15A	80:	152-0323-
CR:	152-0141-			SEMICONDUCTOR DEVICE:SILICON,30V,150MA	80:	152-0141-
CR:	152-0141-			SEMICONDUCTOR DEVICE:SILICON,30V,150MA	80:	152-0141-
CR:	152-0323-			SEMICONDUCTOR DEVICE:SILICON,35V,0.15A	80:	152-0323-
CR:	152-0323-			SEMICONDUCTOR DEVICE:SILICON,35V,0.15A	80:	152-0323-
CR:	152-0141-			SEMICONDUCTOR DEVICE:SILICON,30V,150MA	80:	152-0141-
CR:	152-0141-			SEMICONDUCTOR DEVICE:SILICON,30V,150MA	80:	152-0141-
CR:	152-0141-			SEMICONDUCTOR DEVICE:SILICON,30V,150MA	80:	152-0141-
CR:	152-0141-			SEMICONDUCTOR DEVICE:SILICON,30V,150MA	80:	152-0141-
CR:	152-0141-			SEMICONDUCTOR DEVICE:SILICON,30V,150MA	80:	152-0141-
CR:	152-0141-			SEMICONDUCTOR DEVICE:SILICON,30V,150MA	80:	152-0141-
CR:	152-0141-			SEMICONDUCTOR DEVICE:SILICON,30V,150MA	80:	152-0141-
CR:	152-0141-			SEMICONDUCTOR DEVICE:SILICON,30V,150MA	80:	152-0141-
CR:	152-0141-			SEMICONDUCTOR DEVICE:SILICON,30V,150MA	80:	152-0141-
CR:	152-0141-			SEMICONDUCTOR DEVICE:SILICON,30V,150MA	80:	152-0141-
CR:	152-0141-			SEMICONDUCTOR DEVICE:SILICON,30V,150MA	80:	152-0141-
CR:	152-0141-			SEMICONDUCTOR DEVICE:SILICON,30V,150MA	80:	152-0141-
CR:	152-0141-			SEMICONDUCTOR DEVICE:SILICON,30V,150MA	80:	152-0141-
CR:	152-0141-			SEMICONDUCTOR DEVICE:SILICON,30V,150MA	80:	152-0141-
CR:	152-0141-			SEMICONDUCTOR DEVICE:SILICON,30V,150MA	80:	152-0141-
CR:	152-0141-			SEMICONDUCTOR DEVICE:SILICON,30V,150MA	80:	152-0141-

Ckt No.	Tektronix Serial/Model No.		Dscnt	Name & Description	Mfr		
	Part No.	Eff			Code	Mfr	Part Number
CR630	152-0141-02			SEMICOND DEVICE:SILICON,30V,150MA	80009		152-0141-02
DS101	150-0093-00	B010100	B039999	LAMP, INCAND:5.0V,0.06A	71744		6833AS15
DS101	150-0057-01	B040000	B059999	LAMP, INCAND:5V,0.115A,WIRE LD,SEL	87034		17AS15
DS101	150-0048-01	B060000		LAMP, INCAND:5V,0.06A,SEL	08806		683AS15
DS301	150-0046-00			LAMP, INCAND:10V,0.04A	08806		2107D
F119	159-0024-00			FUSE,CARTRIDGE:3AG,0.06A,250V,FAST BLOW	71400		AGC 1/16
F219	159-0024-00			FUSE,CARTRIDGE:3AG,0.06A,250V,FAST BLOW	71400		AGC 1/16
J101	131-0679-00	B010100	B093219	CONNECTOR,RCPT,:BNC W/HARDWARE	24931		28JR168-1
J101	131-0679-02	B093220		CONNECTOR,RCPT,:BNC W/HARDWARE	24931		28JR270-1
J201	131-0679-01	B010100	B093219	CONNECTOR,RCPT,:BNC W/HARDWARE	24931		28JR168-1
J201	131-0679-02	B093220		CONNECTOR,RCPT,:BNC W/HARDWARE	24931		28JR270-1
Q133	151-1027-00	B010100	B099999	TRANSISTOR:SILICON,FET,N-CHAN	30009		151-1027-00
Q133	151-1101-00	B100000		TRANSISTOR:SILICON,FET,N CHANNEL	37014		2N5565
Q144	151-0261-00			TRANSISTOR:SILICON,PNP,DUAL	30009		151-0261-00
Q153	151-1028-00			TRANSISTOR:SILICON,FET,N CHANNEL	15818		1J908
Q253	151-1028-00			TRANSISTOR:SILICON,FET,N CHANNEL	15818		1J908
Q264	151-0261-00			TRANSISTOR:SILICON,PNP,DUAL	30009		151-0261-00
Q273	151-0128-00			TRANSISTOR:GE PNP	34713		2N2140
Q283	151-0128-00			TRANSISTOR:GE PNP	34713		2N2140
Q284	151-0195-00			TRANSISTOR:SILICON,NPN	30009		151-0195-00
Q304	151-0260-00			TRANSISTOR:SILICON,NPN	30009		151-0260-00
Q314	151-0220-00			TRANSISTOR:SILICON,PNP	30009		151-0220-00
Q324	151-0228-00			TRANSISTOR:SILICON,PNP,SEL FROM 2N4888	30009		151-0228-00
Q334	151-0228-00			TRANSISTOR:SILICON,PNP,SEL FROM 2N4888	30009		151-0228-00
Q344	151-0195-00			TRANSISTOR:SILICON,NPN	30009		151-0195-00
Q354	151-0195-00			TRANSISTOR:SILICON,NPN	30009		151-0195-00
Q404	151-1019-00	B010100	B069999	TRANSISTOR:SILICON,FET,N-CHANNEL	30009		151-1019-00
Q404	151-1050-00	B070000		TRANSISTOR:SILICON,FET,N-CHANNEL,DUAL	30009		151-1050-00
Q414	151-0261-00			TRANSISTOR:SILICON,PNP,DUAL	30009		151-0261-00
Q424	151-0219-00			TRANSISTOR:SILICON,PNP	30009		151-0219-00
Q434	151-0219-00			TRANSISTOR:SILICON,PNP	30009		151-0219-00
Q444	151-0219-00			TRANSISTOR:SILICON,PNP	30009		151-0219-00
Q454	151-0219-00			TRANSISTOR:SILICON,PNP	30009		151-0219-00
Q524	151-0219-00			TRANSISTOR:SILICON,PNP	30009		151-0219-00
Q534	151-0219-00			TRANSISTOR:SILICON,PNP	30009		151-0219-00
Q544	151-0219-00			TRANSISTOR:SILICON,PNP	30009		151-0219-00
Q554	151-0219-00			TRANSISTOR:SILICON,PNP	30009		151-0219-00
Q614	151-0254-00	B010100	B116609	TRANSISTOR:SILICON,NPN	30009		151-0254-00
Q614	151-0281-00	B116610		TRANSISTOR:SILICON,NPN	33508		16P4039
R103	115-0105-00			RES.,FXD,CMPSN:1M OHM,5%,0.25W	31121		2B1055
R108C	123-0611-07			RES.,FXD,FILM:900K OHM,0.1%,0.5W	31637		4FF1226C90002B
R108D	121-0389-01			RES.,FXD,FILM:110K OHM,0.5%,0.125W	31637		4FF1816G11002D
R108E	111-0609-00			RES.,VAR, NONWIR:2K OHM,10%,0.50W	73138		32-26-0
R109C	123-0614-07			RES.,FXD,FILM:990K OHM,0.1%,0.5W	31637		4FF1226C99002B
R109D	121-0289-00			RES.,FXD,FILM:10K OHM,1%,0.125W	31637		4FF1816G10001F
R109E	111-0605-00			RES.,VAR, NONWIR:200 OHM,10%,0.50W	30740		32-54-3
R110C	123-0623-07			RES.,FXD,FILM:999K OHM,0.1%,0.5W	31637		4FF1226C99902B
R110D	121-0197-00			RES.,FXD,FILM:1.1K OHM,1%,0.125W	31637		4FF1816G11000F
R110E	111-0609-00			RES.,VAR, NONWIR:2K OHM,10%,0.50W	73138		32-26-0
R110F	121-0289-01			RES.,FXD,FILM:10K OHM,0.5%,0.125W	31637		4FF1816G10001D
R111	121-0481-07			RES.,FXD,FILM:1M OHM,0.1%,0.125W	31637		1MF188C10003B

Ckt No.	Tektronix Serial/ Model No.			Name & Description	Mfr	
	Part No.	Eff	Dscont		Code	Mfr Part Number
R115	311-0827-00	B010100	B069999	RES.,VAR, NONWIR:TRMR,250 OHM,0.5W	01121	SV2511
R115	311-1260-00	B070000		RES.,VAR, NONWIR:250 OHM,10%,0.50W	32997	3329 P-L58-251
R116	311-0635-00			RES.,VAR, NONWIR:1K OHM,10%,0.50W	73138	82-32-0
R117	321-0210-00			RES.,FXD,FILM:1.5K OHM,1%,0.125W	91637	MFF1816G15000F
R119	315-0510-00			RES.,FXD,CMPSN:51 OHM,5%,0.25W	01121	CB5105
R121	321-0344-00			RES.,FXD,FILM:37.4K OHM,1%,0.125W	91637	MFF1816G37401F
R123	315-0151-00			RES.,FXD,CMPSN:150 OHM,5%,0.25W	01121	CB1515
R133	308-0495-00			RES.,FXD,WW:4.5K OHM,0.1%	91637	RS2B110-45000B
R141	315-0512-00			RES.,FXD,CMPSN:5.1K OHM,5%,0.25W	01121	CB5125
R145	321-0289-00			RES.,FXD,FILM:10K OHM,1%,0.125W	91637	MFF1816G10001F
R151	308-0546-00			RES.,FXD,WW:125 OHM,0.1%,3W	91637	RS2B110-125R0B
R153	321-0114-00			RES.,FXD,FILM:150 OHM,1%,0.125W	91637	MFF1816G150R0F
R155	315-0101-00			RES.,FXD,CMPSN:100 OHM,5%,0.25W	01121	CB1015
R157	321-0030-00			RES.,FXD,FILM:20 OHM,1%,0.125W	91637	MFF1816G20R00F
R159	308-0436-00			RES.,FXD,WW:2K OHM,0.1%,3W	91637	RS2B-A20000B
R203	315-0105-00			RES.,FXD,CMPSN:1M OHM,5%,0.25W	01121	CB1055
R208C	323-0611-07			RES.,FXD,FILM:900K OHM,0.1%,0.5W	91637	MFF1226C90002B
R208D	321-0389-01			RES.,FXD,FILM:110K OHM,0.5%,0.125W	91637	MFF1816G11002D
R209C	323-0614-07			RES.,FXD,FILM:990K OHM,0.1%,0.5W	91637	MFF1226C99002B
R209D	321-0289-00			RES.,FXD,FILM:10K OHM,1%,0.125W	91637	MFF1816G10001F
R210C	323-0623-07			RES.,FXD,FILM:999K OHM,0.1%,0.5W	91637	MFF1226C99902B
R210D	321-0197-00			RES.,FXD,FILM:1.1K OHM,1%,0.125W	91637	MFF1816G11000F
R210F	321-0289-01			RES.,FXD,FILM:10K OHM,0.5%,0.125W	91637	MFF1816G10001D
R211	323-0481-07			RES.,FXD,FILM:1M OHM,0.1%,0.50W	75042	CECT9-1004B
R215	311-0827-00	B010100	B069999	RES.,VAR, NONWIR:TRMR,250 OHM,0.5W	01121	SV2511
R215	311-1260-00	B070000		RES.,VAR, NONWIR:250 OHM,10%,0.50W	32997	3329P-L58-251
R217	321-0222-00			RES.,FXD,FILM:2K OHM,1%,0.125W	91637	MFF1816G20000F
R219	315-0510-00			RES.,FXD,CMPSN:51 OHM,5%,0.25W	01121	CB5105
R227	315-0562-00			RES.,FXD,CMPSN:5.6K OHM,5%,0.25W	01121	CB5625
R233	308-0495-00			RES.,FXD,WW:4.5K OHM,0.1%	91637	RS2B110-45000B
R241	315-0512-00			RES.,FXD,CMPSN:5.1K OHM,5%,0.25W	01121	CB5125
R245	321-0289-00			RES.,FXD,FILM:10K OHM,1%,0.125W	91637	MFF1816G10001F
R251	308-0546-00			RES.,FXD,WW:125 OHM,0.1%,3W	91637	RS2B110-125R0B
R253	321-0114-00			RES.,FXD,FILM:150 OHM,1%,0.125W	91637	MFF1816G150R0F
R255	315-0101-00			RES.,FXD,CMPSN:100 OHM,5%,0.25W	01121	CB1015
R256	315-0185-00			RES.,FXD,CMPSN:1.8M OHM,5%,0.25W	01121	CB1855
R257	321-0030-00			RES.,FXD,FILM:20 OHM,1%,0.125W	91637	MFF1816G20R00F
R258	311-0467-00			RES.,VAR, NONWIR:100K OHM,20%,0.50W	11237	300SF-41334
R259	308-0436-00			RES.,FXD,WW:2K OHM,0.1%,3W	91637	RS2B-A20000B
R261	321-0126-00			RES.,FXD,FILM:200 OHM,1%,0.125W	91637	MFF1816G200R0F
R263	321-0385-00			RES.,FXD,FILM:100K OHM,1%,0.125W	91637	MFF1816G10002F
R264	321-0414-00			RES.,FXD,FILM:200K OHM,1%,0.125W	91637	MFF1816G20002F
R265	311-0887-00			RES.,VAR, NONWIR:50K OHM,10%,0.50W	80009	311-0887-00
R267	321-0385-00			RES.,FXD,FILM:100K OHM,1%,0.125W	91637	MFF1816G10002F
R269	321-0126-00			RES.,FXD,FILM:200 OHM,1%,0.125W	91637	MFF1816G200R0F
R270	311-0889-00			RES.,VAR,WW:PNL,5K OHM,1W	02111	162-214
R271	308-0436-00			RES.,FXD,WW:2K OHM,0.1%,3W	91637	RS2B-A20000B
R273	321-0114-00			RES.,FXD,FILM:150 OHM,1%,0.125W	91637	MFF1816G150R0F
R275	311-0532-00			RES.,VAR,WW:TRMR,1.5K OHM,1W	80294	3345P-1-152
R277	321-0114-00			RES.,FXD,FILM:150 OHM,1%,0.125W	91637	MFF1816G150R0F
R279	308-0436-00			RES.,FXD,WW:2K OHM,0.1%,3W	91637	RS2B-A20000B
R281	321-0126-00			RES.,FXD,FILM:200 OHM,1%,0.125W	91637	MFF1816G200R0F
R283	323-0220-00			RES.,FXD,FILM:1.91K OHM,1%,0.50W	75042	CECT0-1911F

Ckt No.	Tektronix Part No.	Serial/Model No. Eff	Dscont	Name & Description	Mfr Code	Mfr Part Number
R285	321-0423-00			RES., FXD, FILM:249K OHM, 1%, 0.125W	91637	MFF1816G24902F
R287	308-0633-00			RES., FXD, WW:475 OHM, 0.1%, 3W	91637	RS2E-B475ROB
R289	308-0633-00			RES., FXD, FILM:475 OHM, 0.1%, 3W	91637	RS2E-B475ROB
R291	321-0423-00			RES., FXD, FILM:249K OHM, 1%, 0.125W	91637	MFF1816G24902F
R293	323-0214-00			RES., FXD, FILM:1.65K OHM, 1%, 0.50W	75042	CECT0-1651F
R301	323-0256-00			RES., FXD, FILM:4.53K OHM, 1%, 0.50W	75042	CECT0-4531F
R303	317-0511-00			RES., FXD, CMPSN:510 OHM, 5%, 0.125W	01121	BB5115
R305	315-0103-00			RES., FXD, CMPSN:10K OHM, 5%, 0.25W	01121	CB1035
R307	315-0130-00			RES., FXD, CMPSN:13 OHM, 5%, 0.25W	01121	CB1305
R309	315-0512-00			RES., FXD, CMPSN:5.1K OHM, 5%, 0.25W	01121	CB5125
R311	315-0513-00			RES., FXD, CMPSN:51K OHM, 5%, 0.25W	01121	CB5135
R313	315-0101-00			RES., FXD, CMPSN:100 OHM, 5%, 0.25W	01121	CB1015
R315	315-0222-00			RES., FXD, CMPSN:2.2K OHM, 5%, 0.25W	01121	CB2225
R323	301-0562-00			RES., FXD, CMPSN:5.6K OHM, 5%, 0.50W	01121	EB5625
R325	321-0160-00			RES., FXD, FILM:453 OHM, 1%, 0.125W	91637	MFF1816G453ROF
R331	315-0473-00			RES., FXD, CMPSN:47K OHM, 5%, 0.25W	01121	CB4735
R333	315-0433-00			RES., FXD, CMPSN:43K OHM, 5%, 0.25W	01121	CB4335
R335	321-0184-00			RES., FXD, FILM:806 OHM, 1%, 0.125W	91637	MFF1816G806ROF
R337	315-0104-00			RES., FXD, CMPSN:100K OHM, 5%, 0.25W	01121	CB1045
R341	315-0364-00			RES., FXD, CMPSN:360K OHM, 5%, 0.25W	01121	CB3645
R343	315-0363-00			RES., FXD, CMPSN:36K OHM, 5%, 0.25W	01121	CB3635
R345	315-0105-00			RES., FXD, CMPSN:1M OHM, 5%, 0.25W	01121	CB1055
R349	315-0204-00			RES., FXD, CMPSN:200K OHM, 5%, 0.25W	01121	CB2045
R351	315-0151-00			RES., FXD, CMPSN:150 OHM, 5%, 0.25W	01121	CB1515
R35 3A	321-0303-00			RES., FXD, FILM:14K OHM, 1%, 0.125W	91637	MFF1816G14001F
R353B	321-0408-00			RES., FXD, FILM:174K OHM, 1%, 0.125W	91637	MFF1816G17402F
R353C	301-0165-00			RES., FXD, CMPSN:1.6M OHM, 5%, 0.50W	01121	EB1655
R353D	321-0303-00			RES., FXD, FILM:14K OHM, 1%, 0.125W	91637	MFF1816G14001F
R353E	321-0408-00			RES., FXD, FILM:174K OHM, 1%, 0.125W	91637	MFF1816G17402F
R353F	301-0165-00			RES., FXD, CMPSN:1.6M OHM, 5%, 0.50W	01121	EB1655
R401	315-0202-00			RES., FXD, CMPSN:2K OHM, 5%, 0.25W	01121	CB2025
R403	321-0272-00			RES., FXD, FILM:6.65K OHM, 1%, 0.125W	91637	MFF1816G66500F
R405	321-0039-00			RES., FXD, FILM:24.9 OHM, 1%, 0.125W	91637	MFF1816G2490F
R407A	321-0001-01			RES., FXD, FILM:10 OHM, 0.5%, 0.125W	91637	MFF1816G10R00D
R407B	321-0762-01			RES., FXD, FILM:20.1 OHM, 0.5%, 0.125W	91637	MFF1816G20R10D
R407C	321-1068-01			RES., FXD, FILM:50.5 OHM, 0.5%, 0.125W	91637	MFF1816G50R50D
R407D	321-0098-01			RES., FXD, FILM:102 OHM, 0.5%, 0.125W	91637	MFF1816G102R0D
R407E	321-0127-01			RES., FXD, FILM:205 OHM, 0.5%, 0.125W	91637	MFF1816G205R0D
R407F	321-1166-01			RES., FXD, FILM:530 OHM, 0.5%, 0.125W	91637	MFF1816G530R0D
R407G	321-0763-07			RES., FXD, FILM:1.12K OHM, 0.1%, 0.125W	91637	MFF1816C11200B
R407H	321-1231-01			RES., FXD, FILM:2.52K OHM, 0.5%, 0.125W	91637	MFF1816G25200D
R407J	321-1289-01			RES., FXD, FILM:10.1K OHM, 0.5%, 0.125W	91637	MFF1816G10101D
R407K	321-0332-00			RES., FXD, FILM:28K OHM, 1%, 0.125W	91637	MFF1816G28001F
R409	321-0343-00			RES., FXD, FILM:36.5K OHM, 1%, 0.125W	91637	MFF1816G36501F
R413	321-0361-00			RES., FXD, FILM:56.2K OHM, 1%, 0.125W	91637	MFF1816G56201F
R421	321-0614-00			RES., FXD, FILM:10.1K OHM, 1%, 0.125W	91637	MFF1816G10101F
R423	315-0101-00			RES., FXD, CMPSN:100 OHM, 5%, 0.25W	01121	CB1015
R425	311-0704-00	B010100	B069999	RES., VAR, NONWIR:TRMR, 500 OHM, 0.5W	73138	91-101-0
R425	311-1261-00	B070000		RES., VAR, NONWIR:500 OHM, 10%, 0.50W	32997	3329P-L58-501
R427	321-0227-00			RES., FXD, FILM:2.26K OHM, 1%, 0.125W	91637	MFF1816G22600F
R430 ¹	311-0888-00	B010100	B069999	RES., VAR, NONWIR:PNL, 2X10K OHM, 0.5W	12697	381-CM40098
R430 ¹	311-0888-01	B070000		RES., VAR, NONWIR:PNL, 2X10K OHM, 0.5W	12697	D381S-CM40098
R431	321-0334-00			RES., FXD, FILM:29.4K OHM, 1%, 0.125W	91637	MFF1816G29401F

¹Furnished as a unit with S622.

Ckt No.	Tektronix Part No.	Serial/ Eff	Model No. Dscont	Name & Description	Mfr Code	Mfr Part Number
R432	321-0164-00			RES.,FXD,FILM:499 OHM,1%,0.125W	91637	MFF1816G499ROF
R433	321-0335-00			RES.,FXD,FILM:30.1K OHM,1%,0.125W	91637	MFF1816G30101F
R434	321-0211-00			RES.,FXD,FILM:1.54K OHM,1%,0.125W	91637	MFF1816G15400F
R436	321-0197-00			RES.,FXD,FILM:1.1K OHM,1%,0.125W	91637	MFF1816G11000F
R437	321-0260-00			RES.,FXD,FILM:4.99K OHM,1%,0.125W	91637	MFF1816G49900F
R440	321-0143-00	B010100	B029999	RES.,FXD,FILM:301 OHM,1%,0.125W	91637	MFF1816G301ROF
R440	321-0149-00	B030000		RES.,FXD,FILM:348 OHM,1%,0.125W	91637	MFF1816G348ROF
R441	321-0222-00	B010100	B029999	RES.,FXD,FILM:2K OHM,1%,0.125W	91637	MFF1816G20000F
R441	321-0202-00	B030000		RES.,FXD,FILM:1.24K OHM,1%,0.125W	91637	MFF1816G12400F
R443	317-0561-00	B010100	B029999	RES.,FXD,CMPSN:560 OHM,5%,0.125W	01121	BB5615
R443	317-0391-00	B030000	B089999	RES.,FXD,CMPSN:390 OHM,5%,0.125W	01121	BB3915
R443	315-0391-00			RES.,FXD,CMPSN:390 OHM,5%,0.25W	01121	CB3915
R445	321-0251-00	B010100	B029999	RES.,FXD,FILM:4.02K OHM,1%,0.125W	91637	MFF1816G40200F
R445	321-0231-00	B030000		RES.,FXD,FILM:2.49K OHM,1%,0.125W	91637	MFF1816G24900F
R450	321-0147-00	B010100	B029999	RES.,FXD,FILM:332 OHM,1%,0.125W	91637	MFF1816G332ROF
R450	321-0149-00	B030000		RES.,FXD,FILM:348 OHM,1%,0.125W	91637	MFF1816G348ROF
R451	321-0222-00	B010100	B029999	RES.,FXD,FILM:2K OHM,1%,0.125W	91637	MFF1816G20000F
R451	321-0202-00	B030000		RES.,FXD,FILM:1.24K OHM,1%,0.125W	91637	MFF1816G12400F
R453	321-0251-00	B010100	B029999	RES.,FXD,FILM:4.02K OHM,1%,0.125W	91637	MFF1816G40200F
R453	321-0231-00	B030000		RES.,FXD,FILM:2.49K OHM,1%,0.125W	91637	MFF1816G24900F
R457	317-0241-00	B010100	B089999	RES.,FXD,CMPSN:240 OHM,5%,0.125W	01121	BB2415
R457	315-0241-00			RES.,FXD,CMPSN:240 OHM,5%,0.25W	01121	CB2415
R458	301-0470-00			RES.,FXD,CMPSN:470 OHM,5%,0.50W	01121	EB4705
R459	315-0510-00			RES.,FXD,CMPSN:51 OHM,5%,0.25W	01121	CB5105
R501	315-0202-00			RES.,FXD,CMPSN:2K OHM,5%,0.25W	01121	CB2025
R503	321-0272-00			RES.,FXD,FILM:6.65K OHM,1%,0.125W	91637	MFF1816G66500F
R505	311-0839-00	B010100	B099999	RES.,VAR,WW:TRMR,50 OHM,0.5W	80294	3305P-1-500
R505	311-1258-00	B100000		RES.,VAR,NONWIR:50 OHM,10%,0.50W	32997	3326 P-T02-500
R509	321-0343-00			RES.,FXD,FILM:36.5K OHM,1%,0.125W	91637	MFF1816G36501F
R513	321-0361-00			RES.,FXD,FILM:56.2K OHM,1%,0.125W	91637	MFF1816G56201F
R521	321-0614-00			RES.,FXD,FILM:10.1K OHM,1%,0.125W	91637	MFF1816G10101F
R523	315-0101-00			RES.,FXD,CMPSN:100 OHM,5%,0.25W	01121	CB1015
R527	321-0227-00			RES.,FXD,FILM:2.26K OHM,1%,0.125W	91637	MFF1816G22600F
R531	321-0334-00			RES.,FXD,FILM:29.4K OHM,1%,0.125W	91637	MFF1816G29401F
R532	321-0164-00			RES.,FXD,FILM:499 OHM,1%,0.125W	91637	MFF1816G499ROF
R533	321-0335-00			RES.,FXD,FILM:30.1K OHM,1%,0.125W	91637	MFF1816G30101F
R534	321-0211-00			RES.,FXD,FILM:1.54K OHM,1%,0.125W	91637	MFF1816G15400F
R535 ¹	311-0949-00			RES.,VAR,NONWIR:2K OHM,10%,0.50W	01121	WA1G040S202UA
R540	311-0702-00			RES.,VAR,NONWIR:250 OHM,10%,0.50W	12697	382-CM39823
R541	321-0222-00	B010100	B029999	RES.,FXD,FILM:2K OHM,1%,0.125W	91637	MFF1816G20000F
R541	321-0202-00	B030000		RES.,FXD,FILM:1.24K OHM,1%,0.125W	91637	MFF1816G12400F
R543	317-0561-00	B010100	B029999	RES.,FXD,CMPSN:560 OHM,5%,0.125W	01121	BB5615
R543	317-0391-00	B030000	B089999	RES.,FXD,CMPSN:390 OHM,5%,0.125W	01121	BB3915
R543	315-0391-00	B090000		RES.,FXD,CMPSN:390 OHM,5%,0.25W	01121	CB3915
R545	321-0251-00	B010100	B029999	RES.,FXD,FILM:4.02K OHM,1%,0.125W	91637	MFF1816G40200F
R545	321-0231-00	B030000		RES.,FXD,FILM:2.49K OHM,1%,0.125W	91637	MFF1816G24900F
R551	321-0222-00	B010100	B029999	RES.,FXD,FILM:2K OHM,1%,0.125W	91637	MFF1816G20000F
R551	321-0202-00	B030000		RES.,FXD,FILM:1.24K OHM,1%,0.125W	91637	MFF1816G12400F
R553	321-0251-00	B010100	B029999	RES.,FXD,FILM:4.02K OHM,1%,0.125W	91637	MFF1816G40200F
R553	321-0231-00	B030000		RES.,FXD,FILM:2.49K OHM,1%,0.125W	91637	MFF1816G24900F
R557	317-0241-00	B010100	B089999	RES.,FXD,CMPSN:240 OHM,5%,0.125W	01121	BB2415
R557	315-0241-00	B090000		RES.,FXD,CMPSN:240 OHM,5%,0.25W	01121	CB2415
R559	315-0510-00			RES.,FXD,CMPSN:51 OHM,5%,0.25W	01121	CB5105

¹Furnished as a unit with S535

Ckt No.	Tektronix Part No.	Serial/Model No. Eff	Dscont	Name & Description	Mfr Code	Mfr Part Number
R618C	315-0154-00			RES.,FXD, CMPSN:150K OHM,5%,0.25W	01121	CB1545
R618D	315-0753-00			RES.,FXD, CMPSN:75K OHM,5%,0.25W	01121	CB7535
R618E	315-0753-00			RES.,FXD, CMPSN:75K OHM,5%,0.25W	01121	CB7535
R618F	315-0154-00			RES.,FXD, CMPSN:150K OHM,5%,0.25W	01121	CB1545
R618G	315-0753-00			RES.,FXD, CMPSN:75K OHM,5%,0.25W	01121	CB7535
R618H	315-0753-00			RES.,FXD, CMPSN:75K OHM,5%,0.25W	01121	CB7535
R618J	315-0123-00			RES.,FXD, CMPSN:12K OHM,5%,0.25W	01121	CB1235
R618K	321-0344-00			RES.,FXD, FILM:37.4K OHM,1%,0.125W	75042	CEATO-3742F
R618L	315-0753-00			RES.,FXD, CMPSN:75K OHM,5%,0.25W	01121	CB7535
R618M	315-0154-00			RES.,FXD, CMPSN:150K OHM,5%,0.25W	01121	CB1545
R618N	315-0513-00			RES.,FXD, CMPSN:51K OHM,5%,0.25W	01121	CB5135
R620	321-0223-00			RES.,FXD, FILM:2.05K OHM,1%,0.125W	75042	CEATO-2051F
R622	315-0222-00			RES.,FXD, CMPSN:2.2K OHM,5%,0.25W	01121	CB2225
R630	315-0104-00			RES.,FXD, CMPSN:100K OHM,5%,0.25W	01121	CB1045
R632	317-0223-00	B030000	B089999	RES.,FXD, CMPSN:22K OHM,5%,0.125W	01121	BB2235
R632	315-0223-00	B090000		RES.,FXD, CMPSN:22K OHM,5%,0.25W	01121	CB2235
R634	317-0203-00	B010100	B089999	RES.,FXD, CMPSN:20K OHM,5%,0.125W	01121	BB2035
R634	315-0203-00	B090000		RES.,FXD, CMPSN:20K OHM,5%,0.25W	01121	CB2035
RT221	307-0181-00			RES.,THERMAL:100K OHM,10%,4MW/DEG C	50157	JP-51J2
RT223	307-0181-00			RES.,THERMAL:100K OHM,10%,4MW/DEG C	50157	JP-51J2
S101A,B ¹	-----	B010100	B059999	CKT BOARD ASSY:AC-GND-DC		
S101A,B ¹	-----	B060000		CKT BOARD ASSY:AC-GND-DC		
S108 ²	670-1014-00	B010100	B029999	CKT BOARD ASSY:MAIN	80009	670-1014-00
S108 ²	670-1014-01	B030000	B059999	CKT BOARD ASSY:MAIN	80009	670-1014-01
S108 ²	670-1014-03	B060000	B069999	CKT BOARD ASSY:MAIN	80009	670-1014-03
S108 ²	670-1014-04	B070000		CKT BOARD ASSY:MAIN	80009	670-1014-04
S201A,B ³	-----	B010100	B059999	CKT BOARD ASSY:+AC-GND-DC		
S201A,B ³	-----	B060000		CKT BOARD ASSY:+AC-GND-DC		
S353 ²	670-1013-00			CKT BOARD ASSY:BANDWIDTH	80009	670-1013-00
S407 ²	670-1014-00	B010100	B029999	CKT BOARD ASSY:MAIN	80009	670-1014-00
S407 ²	670-1014-03	B060000	B069999	CKT BOARD ASSY:MAIN	80009	670-1014-03
S407 ²	670-1014-04	B070000		CKT BOARD ASSY:MAIN	80009	670-1014-04
S426 ²	670-1013-00			CKT BOARD ASSY:BANDWIDTH	80009	670-1013-00
S535 ⁴	311-0949-00			RES.,VAR, NONWIR:2K OHM,10%,0.50W	01121	WA1G040S202UA
S622 ⁵	311-0888-00	B010100	B069999	RES.,VAR, NONWIR:PNL,2X10K OHM,0.5W	12697	381-CM40098
S622 ⁵	311-0888-01	B070000		RES.,VAR, NONWIR:PNL,2X10K OHM,0.5W	12697	D381S-CM40098
VR270	152-0212-00			SEMICONV DEVICE:ZENER,0.5W,9V,5%	04713	SZ50646
VR271	152-0405-00			SEMICONV DEVICE:ZENER,1W,15V,5%	99942	1N5567B
VR305	152-0306-00	B010100	B029999	SEMICONV DEVICE:ZENER,0.4W,9.1V,5%	81483	1N960B
VR305	152-0168-00	B030000		SEMICONV DEVICE:ZENER,0.4W,12V,5%	04713	1N963B
VR320	152-0280-00			SEMICONV DEVICE:ZENER,0.4W,6.2V,5%	04713	1N753A
VR325	152-0212-00			SEMICONV DEVICE:ZENER,0.5W,9V,5%	04713	SZ50646
VR330	152-0280-00			SEMICONV DEVICE:ZENER,0.4W,6.2V,5%	04713	1N753A

¹Replaceable only under Circuit Board Assembly 670-1050-XX.
²See Mechanical Parts List for replacement parts.
³Replaceable only under Circuit Board Assembly 670-1051-XX.
⁴Furnished as a unit with R535.
⁵Furnished as a unit with R430.

SECTION 7 DIAGRAMS and MECHANICAL PARTS ILLUSTRATIONS

The following special symbols are used on the diagrams:

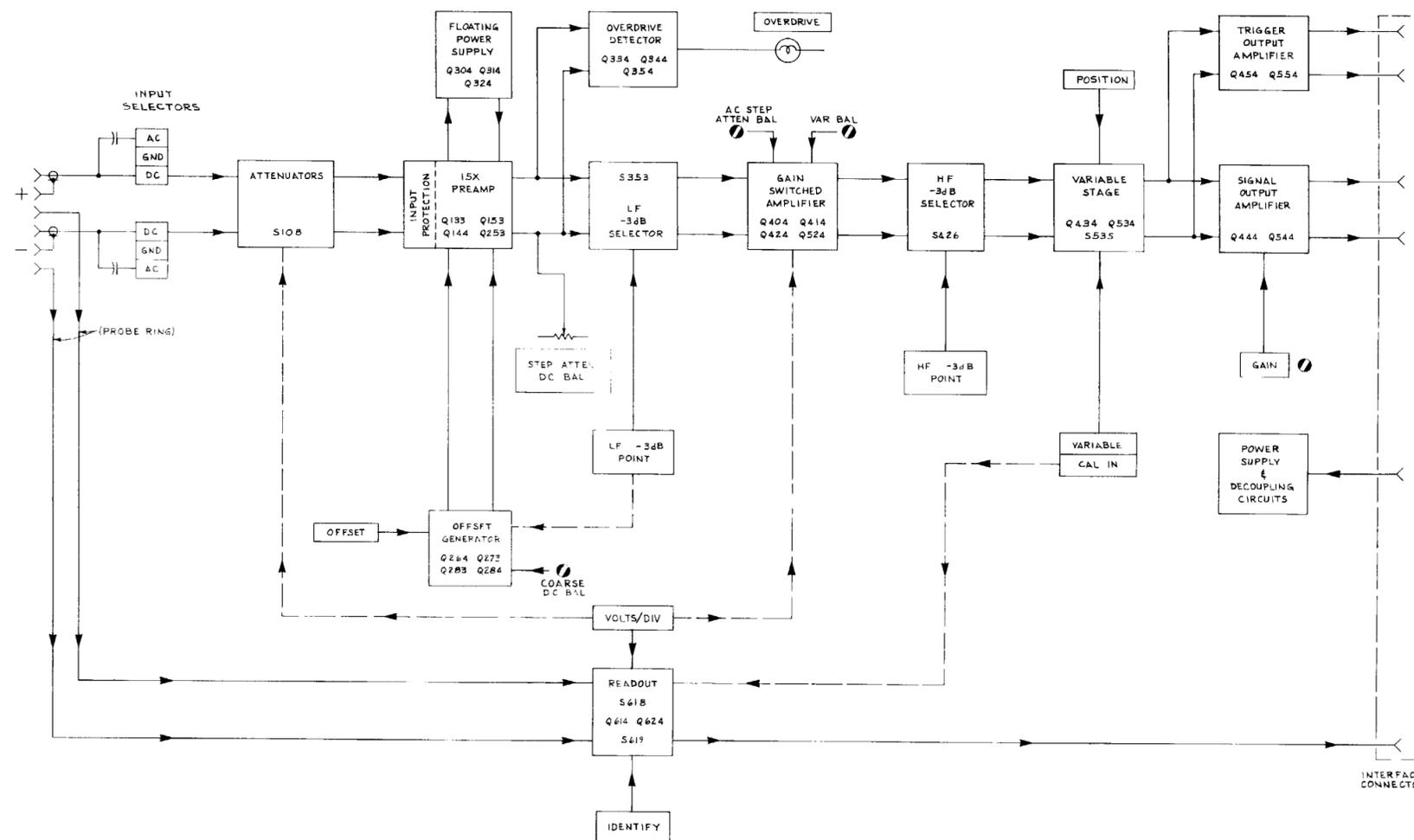
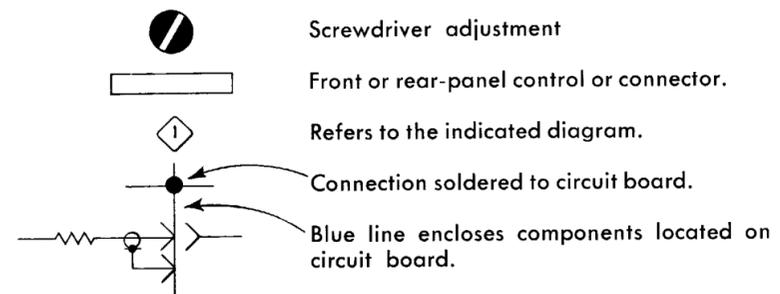

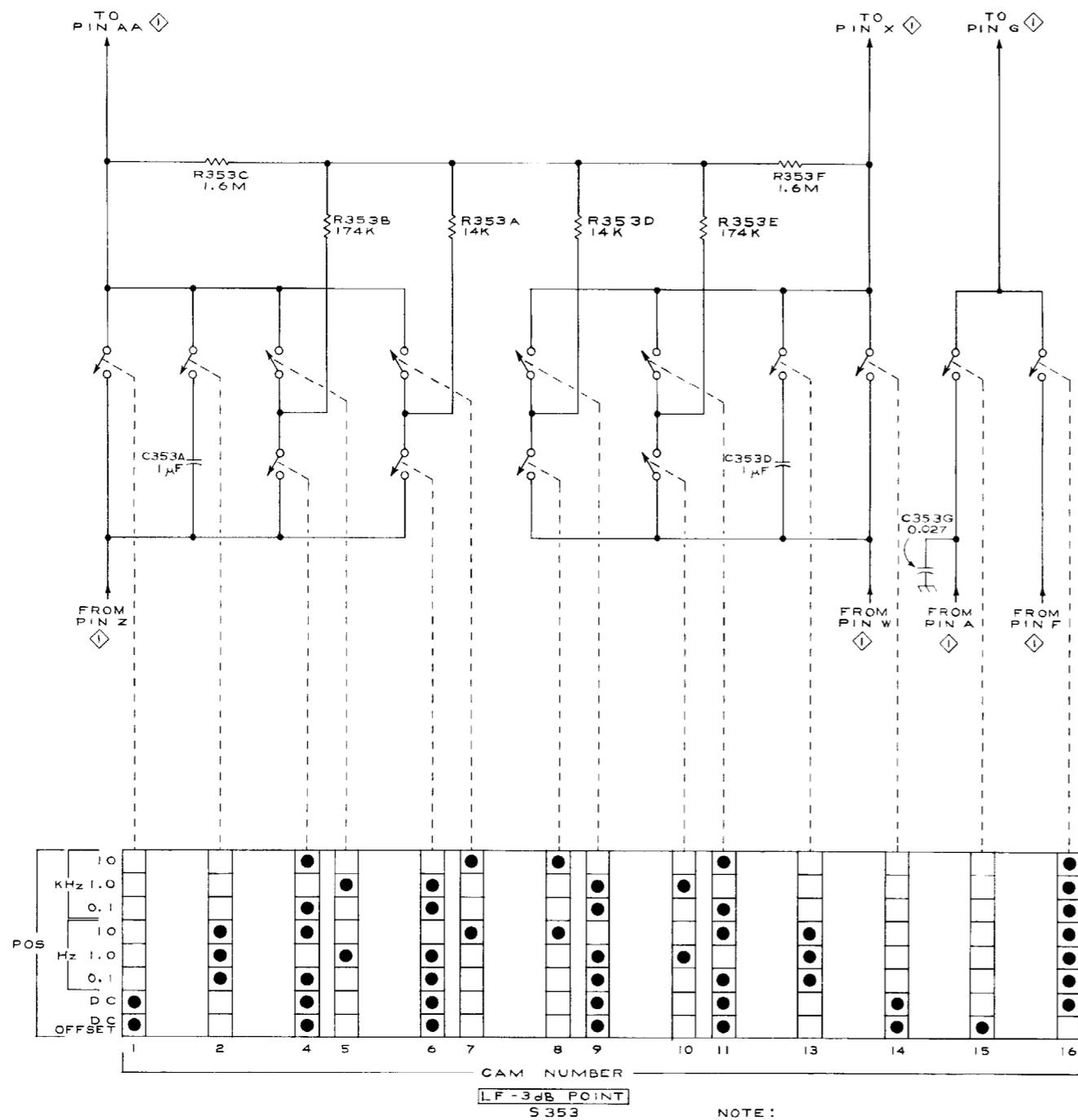

NOTE:
 1. SWITCH CLOSED WHEN DOT PRESENT IN APPLICABLE BOX OF SELECTED SWITCH POSITION
 2. SWITCHES LOCATED ON BANDWIDTH CIRCUIT BOARD

TYPE 7A22

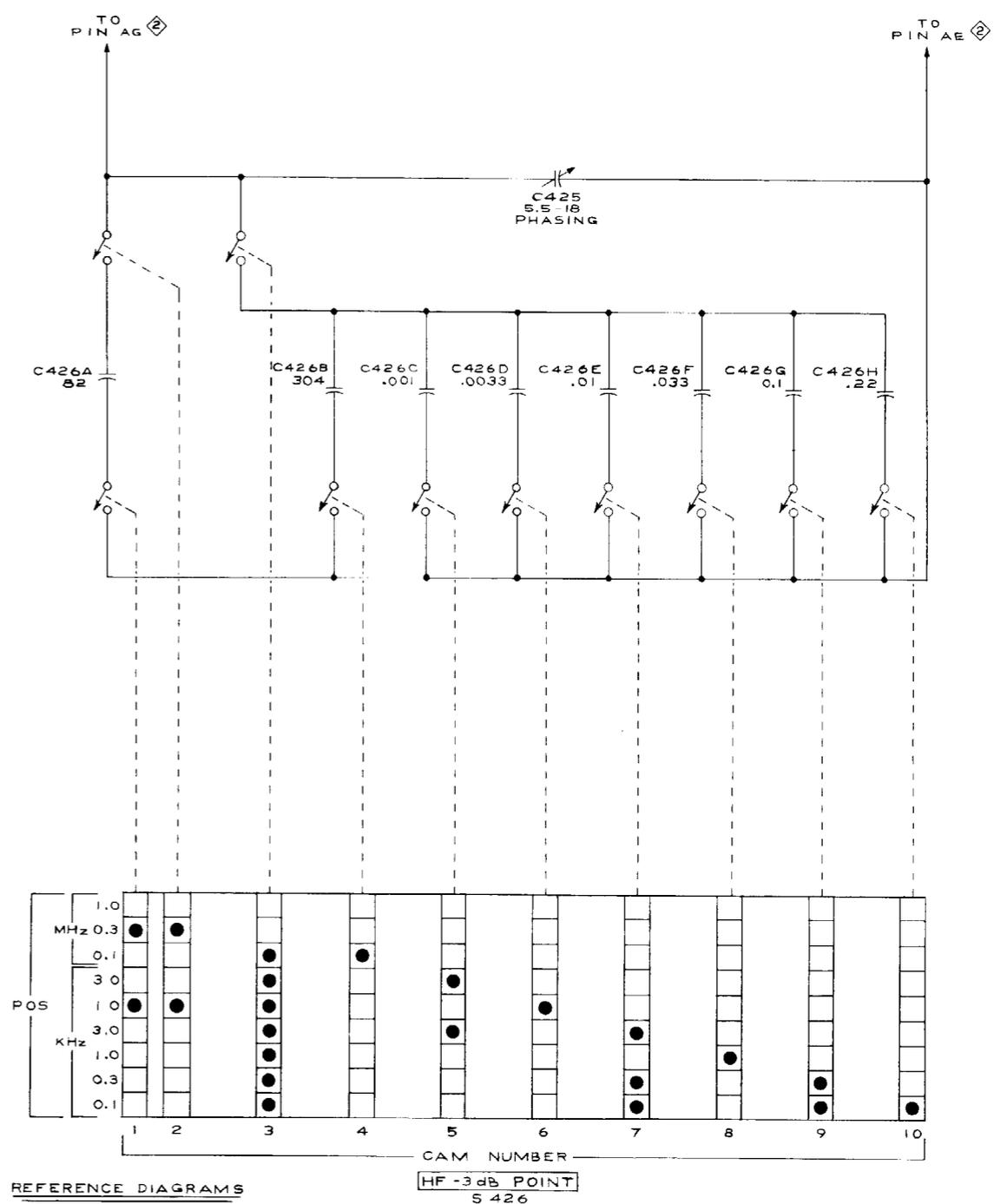

REFERENCE DIAGRAMS
 ① XI5 PREAMP
 ② OUTPUT AMPLIFIER

FREQUENCY SELECTOR SWITCHES

VRS
769

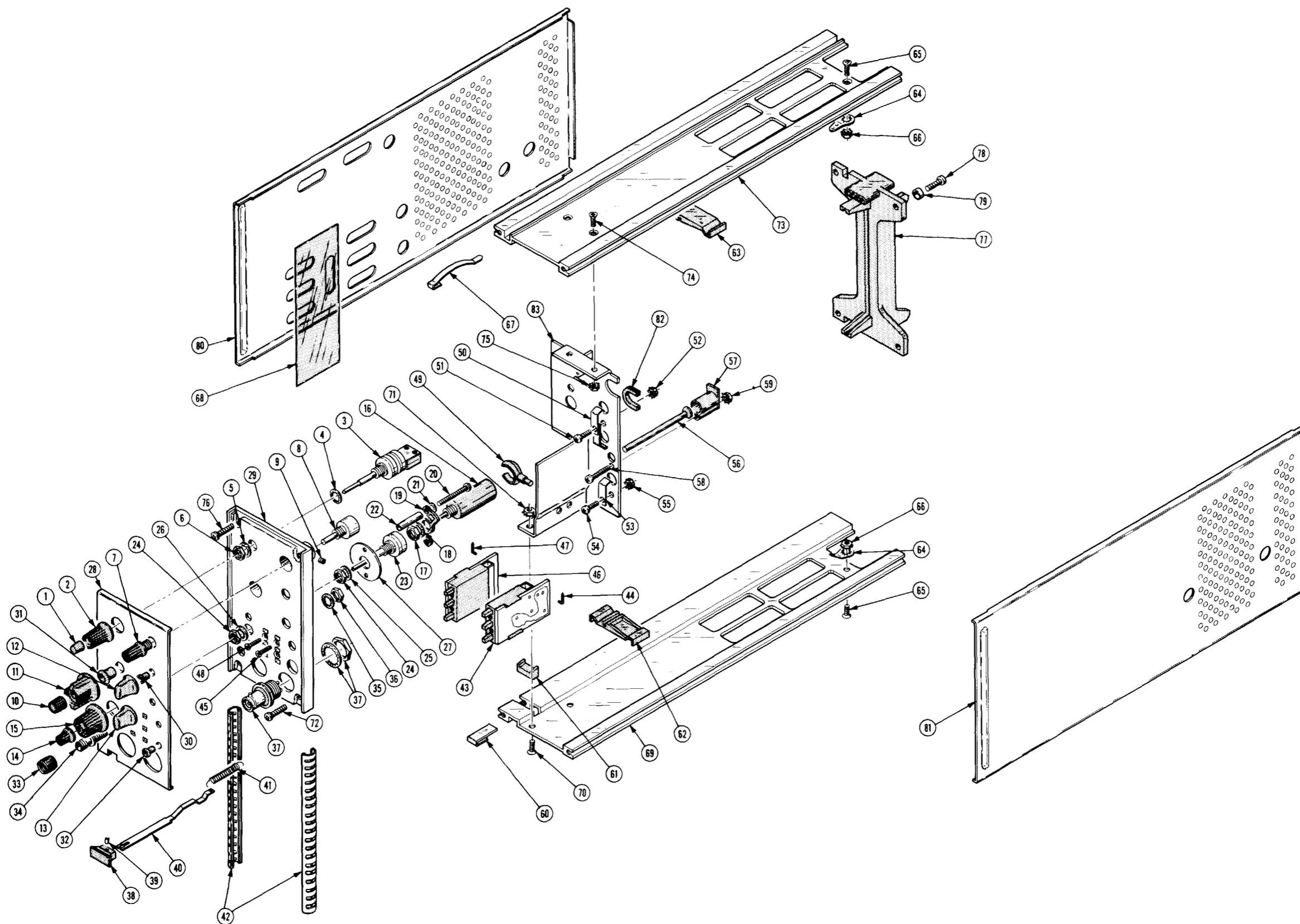

7A22 DIFFERENTIAL AMPLIFIER

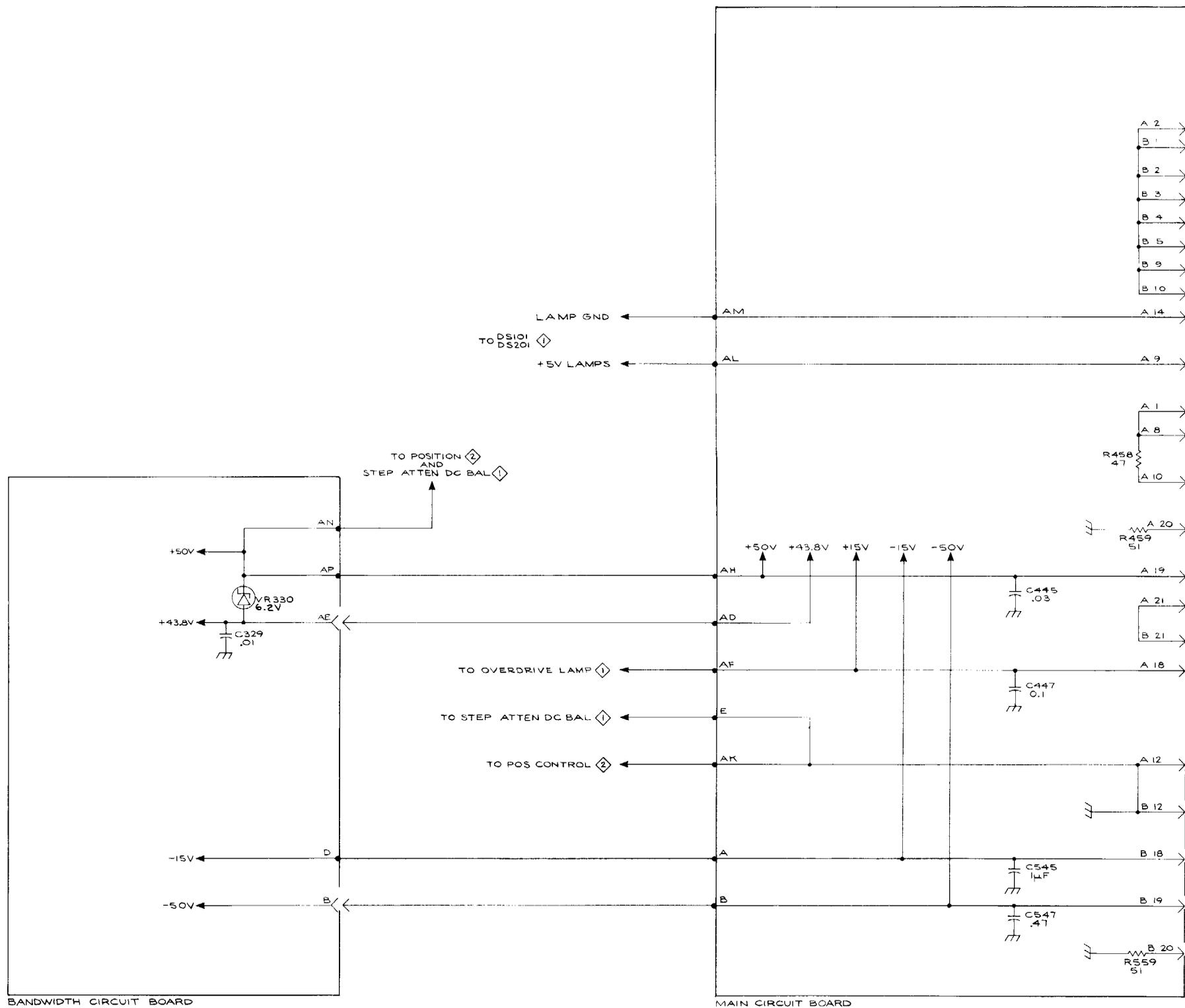

BANDWIDTH CIRCUIT BOARD

MAIN CIRCUIT BOARD

REFERENCE DIAGRAMS
 1 X16 PREAMP
 2 OUTPUT AMPLIFIER

TYPE 7A22

REV. B, FEB. 1978

VOLTAGE DISTRIBUTION 5

WRU
769

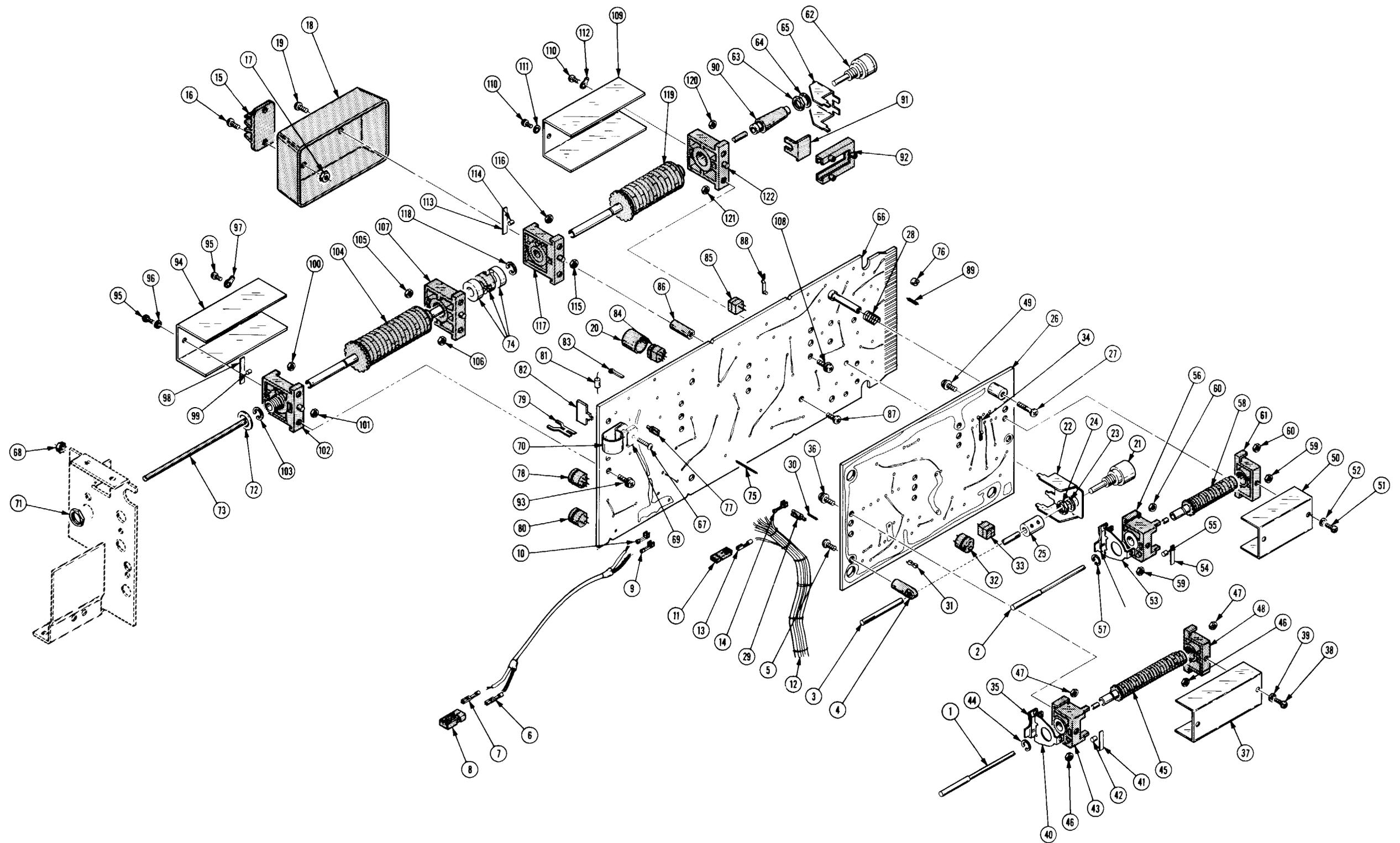

REPLACEABLE MECHANICAL PARTS

PARTS ORDERING INFORMATION

Replacement parts are available from or through your local Tektronix, Inc. Field Office or representative.

Changes to Tektronix instruments are sometimes made to accommodate improved components as they become available, and to give you the benefit of the latest circuit improvements developed in our engineering department. It is therefore important, when ordering parts, to include the following information in your order: Part number, instrument type or number, serial number, and modification number if applicable.

If a part you have ordered has been replaced with a new or improved part, your local Tektronix, Inc. Field Office or representative will contact you concerning any change in part number.

SPECIAL NOTES AND SYMBOLS

- X000 Part first added at this serial number
- 00X Part removed after this serial number

FIGURE AND INDEX NUMBERS

Items in this section are referenced by figure and index numbers to the illustrations.

INDENTATION SYSTEM

This mechanical parts list is indented to indicate item relationships. Following is an example of the indentation system used in the description column.

```

1 2 3 4 5           Name & Description
Assembly and/or Component
Attaching parts for Assembly and/or Component
    - - - * - - -
Detail Part of Assembly and/or Component
Attaching parts for Detail Part
    - - - * - - -
Parts of Detail Part
Attaching parts for Parts of Detail Part
    - - - * - - -
    
```

Attaching Parts always appear in the same indentation as the item it mounts, while the detail parts are indented to the right. Indented items are part of, and included with, the next higher indentation. The separation symbol - - - * - - - indicates the end of attaching parts.

Attaching parts must be purchased separately, unless otherwise specified.

ITEM NAME

In the Parts List, an Item Name is separated from the description by a colon (:). Because of space limitations, an Item Name may sometimes appear as incomplete. For further Item Name identification, the U.S. Federal Cataloging Handbook H6-1 can be utilized where possible.

ABBREVIATIONS

#	INCH NUMBER SIZE	ELECTRN	ELECTRON	IN	INCH	SE	SINGLE END
ACTR	ACTUATOR	ELEC	ELECTRICAL	INCAND	INCANDESCENT	SECT	SECTION
ADPTR	ADAPTER	ELECTLT	ELECTROLYTIC	INSUL	INSULATOR	SEMICON	SEMICONDUCTOR
ALIGN	ALIGNMENT	ELEM	ELEMENT	INTL	INTERNAL	SHLD	SHIELD
AL	ALUMINUM	EPL	ELECTRICAL PARTS LIST	LPHLDR	LAMPHOLDER	SHLDR	SHOULDERED
ASSEM	ASSEMBLED	EQPT	EQUIPMENT	MACH	MACHINE	SKT	SOCKET
ASSY	ASSEMBLY	EXT	EXTERNAL	MECH	MECHANICAL	SL	SLIDE
ATTEN	ATTENUATOR	FIL	FILLISTER HEAD	MTG	MOUNTING	SLFLKG	SELF-LOCKING
AWG	AMERICAN WIRE GAGE	FLEX	FLEXIBLE	NIP	NIPPLE	SLVG	SLEEVING
BD	BOARD	FLH	FLAT HEAD	NON WIRE	NOT WIRE WOUND	SPR	SPRING
BRKT	BRACKET	FLTR	FILTER	OBD	ORDER BY DESCRIPTION	SQ	SQUARE
BRS	BRASS	FR	FRAME or FRONT	OD	OUTSIDE DIAMETER	SST	STAINLESS STEEL
BRZ	BRONZE	FSTNR	FASTENER	OVH	OVAL HEAD	STL	STEEL
BSHG	BUSHING	FT	FOOT	PHBRZ	PHOSPHOR BRONZE	SW	SWITCH
CAB	CABINET	FXD	FIXED	PL	PLAIN or PLATE	T	TUBE
CAP	CAPACITOR	GSKT	GASKET	PLSTC	PLASTIC	TERM	TERMINAL
CER	CERAMIC	HDL	HANDLE	PN	PART NUMBER	THD	THREAD
CHAS	CHASSIS	HEX	HEXAGON	PNH	PAN HEAD	THK	THICK
CKT	CIRCUIT	HEX HD	HEXAGONAL HEAD	PWR	POWER	TNSN	TENSION
COMP	COMPOSITION	HEX SOC	HEXAGONAL SOCKET	RCPT	RECEPTACLE	TPG	TAPPING
CONN	CONNECTOR	HLCPS	HELICAL COMPRESSION	RES	RESISTOR	TRH	TRUSS HEAD
COV	COVER	HLEXT	HELICAL EXTENSION	RGD	RIGID	V	VOLTAGE
CPLG	COUPLING	HV	HIGH VOLTAGE	RLF	RELIEF	VAR	VARIABLE
CRT	CATHODE RAY TUBE	IC	INTEGRATED CIRCUIT	RTNR	RETAINER	W/	WITH
DEG	DEGREE	ID	INSIDE DIAMETER	SCH	SOCKET HEAD	WSHR	WASHER
DWR	DRAWER	IDENT	IDENTIFICATION	SCOPE	OSCILLOSCOPE	XFMR	TRANSFORMER
		IMPLR	IMPELLER	SCR	SCREW	XSTR	TRANSISTOR

CROSS INDEX-MFR. CODE NUMBER TO MANUFACTURER

Mfr. Code	Manufacturer	Address	City, State, Zip
000BK	STAUFFER SUPPLY	105 SE TAYLOR	PORTLAND, OR 97214
00779	AMP, INC.	P O BOX 3608	HARRISBURG, PA 17105
13257	AMERACE, LTD.	10 ESNA PARK DRIVE	MARKHAM, ONTARIO, CANADA
22526	BERG ELECTRONICS, INC.	YOUK EXPRESSWAY	NEW CUMBERLAND, PA 17070
24931	SPECIALTY CONNECTOR CO., INC.	3560 MADISON AVE.	INDIANAPOLIS, IN 46227
55210	GETTIG ENG. AND MFG. COMPANY	PO BOX 85, OFF ROUTE 45	SPRING MILLS, PA 16875
70276	ALLEN MFG. CO.	P. O. DRAWER 570	HARTFORD, CT 06101
71785	TRW, CINCH CONNECTORS	1501 MORSE AVENUE	ELK GROVE VILLAGE, IL 60007
73743	FISCHER SPECIAL MFG. CO.	446 MORGAN ST.	CINCINNATI, OH 45206
74445	HOLO-KROME CO.	31 BROOK ST. WEST	HARTFORD, CT 06110
76854	OAK INDUSTRIES, INC., SWITCH DIV.	S. MAIN ST.	CRYSTAL LAKE, IL 60014
78189	ILLINOIS TOOL WORKS, INC. SHAKEPROOF DIVISION	ST. CHARLES ROAD	ELGIN, IL 60120
79136	WALDES, KOHINOOR, INC.	47-16 AUSTEL PLACE	LONG ISLAND CITY, NY 11101
79807	WROUGHT WASHER MFG. CO.	2100 S. O BAY ST.	MILWAUKEE, WI 53207
80009	TEKTRONIX, INC.	P O BOX 500	BEAVERTON, OR 97077
83385	CENTRAL SCREW CO.	2530 CRESCENT DR.	BROADVIEW, IL 60153
86928	SEASTROM MFG. COMPANY, INC.	701 SONORA AVENUE	GLENDALE, CA 91201
87308	N. L. INDUSTRIES, INC., SOUTHERN SCREW DIV.	P. O. BOX 1360	STATESVILLE, NC 28677
89663	REESE, J. RAMSEY, INC.	71 MURRAY STREET	NEW YORK, NY 10007
93907	CAMCAR SCREW AND MFG. CO.	600 18TH AVE.	ROCKFORD, IL 61101
95987	WECKESSER CO., INC.	4444 WEST IRVING PARK RD.	CHICAGO, IL 60641
99934	RENBRANDT INC.	6 PARMELEE STREET	BOSTON, MA 02118

Fig. & Index No.	Tektronix Part No.	Serial/Model No. Eff Dscont	Qty	1 2 3 4 5					Name & Description	Mfr		
				Code	Mfr Part Number	Part Number						
1-1	366-1059-00		1					PUSH BUTTON:GRAY			366-1059-00	
-2	366-1077-00		1					KNOB: GRAY	80009		366-1077-00	
	213-0153-00		1					. SETSCREW:5-40 X 0.125 INCH,HEX SOC STL	74445		OBD	
-3	-----		1					RESISTOR,VAR: (SEE R430,S622 EPL) (ATTACHING PARTS)				
-4	210-0046-00		1					WASHER,LOCK:INTL,0.26 ID X 0.40" OD,STL	78189	1214	-05-00 -0541C	
-5	210-0940-00		1					WASHER,FLAT:0.25 ID X 0.375 INCH OD,STL	79807		OBD	
-6	210-0583-00		1					NUT, PLAIN, HEX.:0.25-32 X 0.312 INCH, BRS - - - * - - -	73743		2X20224-402	
-7	366-0392-02		1					KNOB: GRAY	80009		366-0392-02	
-8	-----		1					RESISTOR,VAR: (SEE R258 EPL) (ATTACHING PARTS)				
-9	213-0020-00		1					SETSCREW:6-32 X 0.125 INCH,HEX.SOC STL - - - * - - -	70276		OBD	
-10	366-1166-00		1					KNOB: RED	80009		366-1166-00	
	213-0153-00		1					. SETSCREW:5-40 X 0.125 INCH,HEX SOC STL	74445		OBD	
-11	366-1057-00		1					KNOB: GRAY	80009		366-1057-00	
	213-0153-00		1					. SETSCREW:5-40 X 0.125 INCH,HEX SOC STL	74445		OBD	
-12	366-0379-00		1					KNOB:GRAY,MODE	80009		366-0379-00	
	213-0153-00		1					. SETSCREW:5-40 X 0.125 INCH,HEX SOC STL	74445		OBD	
-13	366-0379-00		1					KNOB:GRAY,MODE			366-0379-00	
	213-0153-00		1					. SETSCREW:5-40 X 0.125 INCH,HEX SOC STL	74445		OBD	
-14	366-1084-00		1					KNOB: GRAY	80009		366-1084-00	
	213-0725-00		1					. SETSCREW:3-48 X 0.095 INCH,HEX SOC STL	74445		OBD	
-15	366-1101-00		1					KNOB: GRAY	80009		366-1101-00	
	213-0153-00		1					. SETSCREW:5-40 X 0.125 INCH,HEX SOC STL	74445		OBD	
-16	-----		1					RESISTOR,VAR: (SEE R270 EPL) (ATTACHING PARTS)				
-17	210-0583-00		1					NUT, PLAIN, HEX. :0.25-32 X 0.312 INCH, BRS	73743	2X20224	-402	
-18	210-0046-00		1					WASHER, LOCK: INTL,0.26 ID X 0.40" OD, STL - - - * - - -	78189	1214	-05-00 -0541C	
-19	426-0474-00		1					MOUNT,RESILIENT:S SHAPE (ATTACHING PARTS)	80009	426-0474	-00	
-20	211-0111-00		2					SCREW,MACHINE:2-56 X 1.0 INCH,PNH STL	83385		OBD	
-21	210-0001-00		2					WASHER,LOCK:INTL,0.092 ID X 0.18"OD,STL - - - * - - -	78189	1202	-00-00 -0541C	
-22	361-0280-00		2					SPACER, SLEEVE:0.75 INCH LONG	76854		3-5152-340	
-23	-----		1					RESISTOR,VAR: (SEE R265 EPL) (ATTACHING PARTS)				
-24	210-0583-00		2					NUT, PLAIN, HEX. :0.25-32 X 0.312 INCH, BRS	73743	2X20224	-402	
-25	210-0046-00		1					WASHER,LOCK:INTL,0.26 ID X 0.40" OD,STL	78189	1214	-05-00-0541C	
-26	210-0940-00		1					WASHER,FLAT:0.25 ID X 0.375 INCH OD,STL - - - * - - -	79807		OBD	
-27	386-1095-00		1					PLATE, RES. ,MTG:	76854	15528	-015	
-28	333-1106-00		1					PANEL,FRONT:	80009	333-1106	-00	
-29	386-1447-07		1					SUBPANEL,FRONT:		386-1447	-07	
-30	348-0031-00		2					GROMMET,PLASTIC:0.156 INCH DIA	80009	348-0031	-00	
-31	358-0216-00		1					BUSHING, PLASTIC:0.257 ID X 0.412 INCH OD	80009	358-0216	-00	
-32	358-0378-00		1					BUSHING, SLEEVE: PRESS MOUNT	80009	358-0378	-00	
	129-0053-00		1					POST,BDG,ELEC:UNINSULATED	80009	129-0053	-00	
-33	200-0103-00		1					. NUT, PLAIN, KNURL: 0.25-28 X 0.375" OD,BRASS	80009	200-0103	-00	
-34	355-0507-00		1					. STUD,SHOULDERED:BINDING POST (ATTACHING PARTS)	80009	355-0507	-00	
-35	210-0046-00		1					WASHER, LOCK: INTL,0.26 ID X 0.40" OD, STL	78189	1214	-05-00-0541C	
-36	210-0583-00		1					NUT, PLAIN, HEX.:0.25-32 X 0.312 INCH, BRS - - - * - - -	73743	2X20224	-402	
-37	131-0679-00		2					CONNECTOR,RCPT, :BNC W/HARDWARE	24931	28JRI68	-1	
-38	366-1058-07		1					KNOB: LATCH (ATTACHING PARTS)	80009	366-1058	-07	
-39	214-1095-00		1					PIN, SPG, SPLIT:0.094 OD X 0.187 INCH LONG - - - * - - -	13257	52-022	-094-0187	
-40	105-0076-02		1					REL BAR,LATCH:PLUG-IN UNIT	80009	105-0076	-02	
-41	214-1280-00		1					SPRING,HLCPS:0.14 OD X 1.126"L,0.16"DIA W	80009	214-1280	-00	

Fig. & Index No.	Tektronix Part No.	Serial/Model No. Eff	No. Dscont	Qty	1 2 3 4 5	Name & Description	Mfr Code	Mfr Part Number
1-42	348-0157-00	B010100	B010180	2		SHLD GSKT,ELEC:	80009	348-0157-00
	348-0235-00	B010181		2		SHLD GSKT,ELEC:4.734 INCH LONG	80009	348-0235-00
-43	670-1050-00	B010100	B059999	1		CKT BOARD ASSY:AC GND DC	80009	670-1050-00
	670-1050-01	B060000		1		CKT BOARD ASSY:AC GND DC	80009	670-1050-01
-44	131-0589-00			2		. TERM,PIN:0.46 L X 0.025 SQ.PH BRZ GL (ATTACHING PARTS FOR CKT BD)	22526	47350
-45	211-0156-00			2		SCREW,MACHINE:1-72 X 0.25",82 DEG,FLH STL - - - * - - -	93907	OBD
-46	670-1051-00	B010100	B059999	1		CKT BOARD ASSY:+AC GND DC	80009	670-1051-00
	670-1051-01	B060000		1		CKT BOARD ASSY:+AC GND DC	80009	670-1051-01
-47	131-0589-00			2		TERM, PIN:0.46 L X 0.025 SQ. PH BRZ GL (ATTACHING PARTS FOR CKT BD)	22526	47350
-48	211-0156-00			2		SCREW,MACHINE:1-72 X 0.25",82 DEG,FLH STL - - - * - - -	93907	OBD
-49	352-0068-00			2		HOLDER,TEST PRO:PLASTIC	80009	352-0068-00
-50	131-0664-00			2		CONTACT, ELEC: (ATTACHING PARTS)	80009	131-0664-00
-51	211-0008-00			1		SCREW,MACHINE:4-40 X 0.25 INCH,PNH STL	83385	OBD
-52	210-0586-00			1		NUT,PLAIN,EXT W:4-40 X 0.25 INCH,STL - - - * - - -	78189	211-041800-00
-53	131-0664-00			1		CONTACT, ELEC: (ATTACHING PARTS)	80009	131-0664-00
-54	211-0008-00			1		SCREW,MACHINE:4-40 X 0.25 INCH,PNH STL	83385	OBD
-55	210-0586-00			1		NUT,PLAIN,EXT W:4-40 X 0.25 INCH,STL - - - * - - -	78189	211-041800-00
-56	378-0600-00			1		LENS, LIGHT:INDICATOR,2.428 INCH LONG	80009	378-0600-00
-57	352-0067-00			1		LAMPHOLDER: (ATTACHING PARTS)	80009	352-0067-00
-58	211-0018-00			1		SCREW,MACHINE:4-40 X 0.875 PNH,STL	83385	OBD
-59	210-0406-00			1		NUT,PLAIN,HEX.:4-40 X 0.188 INCH,BRS - - - * - - -	73743	2X12161-402
-60	214-1054-00			1		SPRING,FLAT:0.825 X 0.322,SST	80009	214-1054-00
-61	105-0075-00			1		PAWL:0.475 X 0.21 X 0.184 INCH,PLSTC	80009	105-0075-00
-62	344-0162-00	B010100	B050549	3		CLIP,SPR TNSN:BOTTOM,PLASTIC	80009	344-0162-00
	344-0211-00	B050550		3		CLIP,SPR TNSN:BOTTOM,PLASTIC	80009	344-0211-00
-63	344-0161-00	B010100	B050549	2		CLIP,SPR TNSN:TOP,PLASTIC	80009	344-0161-00
	344-0210-00	B050550		2		CLIP,SPR TNSN:	80009	344-0210-00
-64	210-0201-00			2		TERMINAL,LUG:SE #4 (ATTACHING PARTS FOR EACH)	86928	A373-157-2
-65	211-0101-00			1		SCREW,MACHINE:4-40 X 0.25" 100 DEG,FLH STL	83385	OBD
-66	210-0586-00			1		NUT,PLAIN,EXT W:4-40 X 0.25 INCH,STL - - - * - - -	78189	211-041800-00
-67	214-1061-00			1		SPRING,GROUND:FLAT	80009	214-1061-00
-68	337-1243-00			1		SHIELD,ELEC:4.25 X 1.5",PLSTC,W/ADH	80009	337-1243-00
-69	426-0499-03			1		FR SECT,PLUG-IN:BOTTOM (ATTACHING PARTS)	80009	426-0499-03
-70	211-0101-00			2		SCREW,MACHINE:4-40 X 0.25" 100 DEG,FLH STL	83385	OBD
-71	210-0586-00			2		NUT,PLAIN,EXT W:4-40 X 0.25 INCH,STL	78189	211-041800-00
-72	213-0192-00			2		SCR,TPG,THD FOR:6-32 X 0.50 INCH,PNH STL - - - * - - -	87308	OBD
-73	426-0505-03			1		FR SECT,PLUG-IN:TOP (ATTACHING PARTS)	80009	426-0505-03
-74	211-0101-00			2		SCREW,MACHINE:4-40 X 0.25" 100 DEG,FLH STL	83385	OBD
-75	210-0586-00			2		NUT,PLAIN,EXT W:4-40 X 0.25 INCH,STL	78189	211-041800-00
-76	213-0192-00			2		SCR,TPG,THD FOR:6-32 X 0.50 INCH,PNH STL - - - * - - -	87308	OBD
-77	386-1402-00			1		PANEL,REAR: (ATTACHING PARTS)	80009	386-1402-00
-78	213-0192-00			4		SCR,TPG,THD FOR:6-32 X 0.50 INCH,PNH STL	87308	OBD
-79	361-0326-00			1		SPACER, SLEEVE:0.18 ID X 0.25 OD X 0.10"L - - - * - - -	80009	361-0326-00
-80	337-1145-00	B010100	B069999	1		SHIELD,ELEC:LEFT SIDE	80009	337-1145-00
	337-1145-01	B070000		1		SHIELD,ELEC:LEFT SIDE	80009	337-1145-01

Fig. & Index No.	Tektronix Part No.	Serial/Model No.		Qty	1 2 3 4 5	Name & Description	Mfr	
		Eff	Dscont				Code	Mfr Part Number
1-81	337-1146-00	B010100	B069999	1		SHIELD, ELEC:RIGHT SIDE	80009	337-1146-00
	337-1146-01	B070000		1		SHIELD,ELEC:RIGHT SIDE	80009	337-1146-01
-82	348-0115-00			1		GROMMET, PLASTIC: U-SHP,0.548 XO.462 INCH	80009	348-0115-00
-83	337-1045-00			1		SHIELD, ELEC:INPUT	80009	337-1045-00

Fig. & Index No.	Tektronix Part No.	Serial/Model No. Eff	Dscont	Qty	1 2 3 4 5	Name & Description	Mfr Code	Mfr Part Number
2-1	384-0255-00			1		EXTENSION SHAFT:0.08/0.125 DIA X 5.594" L	80009	384-0255-00
-2	384-0306-00			1		EXTENSION SHAFT:9.5 INCH LONG	80009	384-0306-00
-3	384-0444-00			1		EXTENSION SHAFT:11.062 INCH LONG	80009	384-0444-00
-4	351-0159-00			1		GUIDE,SHAFT:FOR 0.125 OD SHAFT,PLASTIC (ATTACHING PARTS)	80009	351-0159-00
-5	213-0088-00			1		SCR,TPG,THD CTG:4-24 X 0.25 INCH,PNH STL - - - * - - -	83385	OBD
-6	131-0792-02			2		CONTACT,ELEC:0.577"L,18 -20 AWG WIRE	22526	46221
-7	131-0622-00			2		CONTACT,ELEC:0.577"L,28 -32 AWG WIRE	22526	46241
-8	352-0198-00			2		CONN BODY,PL,EL:2 WIRE BLACK	80009	352-0198-00
-9	131-0740-00			2		CONTACT,ELEC:0.315 INCH LONG,18 TO 20 AWG	00779	61508-2
-10	131-0755-00			2		CONTACT,ELEC:0.315 INCH LONG,28 TO 32 AWG	00779	61615-1
-11	352-0169-00			2		CONN BODY,PL,EL:2 WIRE BLACK	80009	352-0169-00
-12	179-1407-00			1		WIRING HARNESS,:MAIN	80009	179-1407-00
-13	131-0707-00			4		CONNECTOR, TERM.:0.48" L,22-26AWG WIRE	22526	75691-005
-14	131-0512-00			27		CONTACT,ELEC:0.315 " L,22-26 AWG WIRE	00779	61507-1
-15	352-0136-00			1		FUSEHOLDER :TEFLON (ATTACHING PARTS)	80009	352-0136-00
-16	211-0008-00			2		SCREW,MACHINE:4-40 X 0.25 INCH,PNH STL	83385	OBD
-17	210-0586-00			2		NUT,PLAIN,EXT W:4-40 X 0.25 INCH,STL - - - * - - -	78189	211-041800-00
-18	200-0902-00			1		COVER,CKT CARD:PLASTIC (ATTACHING PARTS)	80009	200-0902-00
-19	211-0008-00			1		SCREW,MACHINE:4-40 X 0.25 INCH,PNH STL - - - * - - -	83385	OBD
-20	200-0687-01			2		COV, TRANSISTOR:0.438 DIA X 0.47 INCH H	80009	200-0687-01
-21	-----			1		RESISTOR,VAR:(SEE R540 EPL) (ATTACHING PARTS)		
-22	407-0554-00			1		BRKT,COMP MTG:	80009	407-0554-00
-23	210-0046-00			1		WASHER,LOCK:INTL,0.26 ID X 0.40" OD,STL	78189	1214 -05-00 -0541C
-24	210-0583-00			1		NUT, PLAIN, HEX. :0.25-32 X 0.312 INCH, BRS - - - * - - -	73743	2X20224-402
-25	376-0029-00			1		CPLG, SHAFT, RGD:0.128 ID X 0.312 OD X 0.5"L	80009	376-0029-00
	213-0075-00			2		. . SETSCREW:4-40 X 0.094 INCH,HEX SOC STL	000BK	OBD
-26	670-1013-00			1		CKT BOARD ASSY:BANDWIDTH (ATTACHING PARTS)	80009	670-1013-00
-27	211-0155-00			4		SCREW,EXT,RLV B:4-40 X 0.375 INCH,SST	80009	211-0155-00
-28	211-1140-00			4		SPRING,HLCPS :0.251 OD X 0.375" L,SST WIRE - - - * - - -	80009	211-1140-00
-29	351-0155-00			5		INSULATOR,STDF :CONNECTOR,DELRLIN	80009	351-0155-00
-30	131-0608-00			5		TERMINAL,PIN:0.365 L X 0.25 PH,BRZ,GOLD PL	22526	47357
-31	136-0263-01	B010100	B010180	18		SOCKET, PIN TERM: FOR 0.025 INCH SQUARE PIN	00779	85861-2
	136-0263-03	B010181	B094559	18		SOCKET, PIN TERM: FOR 0.025 INCH SQUARE PIN	00779	86250-2
	136-0263-04	B094560		18		SOCKET, PIN TERM: FOR 0.025 INCH SQUARE PIN	22526	48059
-32	136-0183-00			3		SOCKET,PLUG-IN:3 PIN,ROUND	80009	136-0183-00
-33	136-0220-00			3		SOCKET,PLUG-IN:3 PIN,SQUARE	71785	133-23-11-034
-34	131-0604-00			24		CONTACT,ELEC:CKT BD SW, SPR,CU BE	80009	131-0604-00
-35	131-0840-00	XB010181		2		CONTACT,ELEC:GROUNDING	80009	131-0840-00
	105-0415-00			1		DRUM ASSY, CAM S :LOW FREQUENCY (ATTACHING PARTS)	80009	105-0415-00
-36	211-0116-00			4		SCR,ASSEM WSHR:4-40 X 0.312 INCH,PNH BRS - - - * - - -	83385	OBD
-37	200-0996-00			1		COVER,CAM SW: (ATTACHING PARTS)	80009	200-0996-00
-38	211-0022-00			2		SCREW,MACHINE :2-56 X 0.188 INCH,PNH STL	83385	OBD
-39	210-0001-00			2		WASHER,LOCK:INTL,0.092 ID X 0.18"OD,STL - - - * - - -	78189	1202 -00-00 -0541C
-40	407-0714-00			1		BRACKET,CAM SW:	80009	407-0714-00
-41	214-1126-02 ¹			2		SPRING,FLAT:RED COLORED	80009	214-1126-02
-42	214-1127-00 ¹			1		ROLLER, DETENT:0.125 DIA X 0.125 INCH L	80009	214-1127-00
-43	401-0058-00			1		BEARING, CAM SW: FRONT (ATTACHING PARTS)	80009	401-0058-00
-44	354-0219-00			1		RING,RETAINING:FOR 0.25 INCH SHAFT - - - * - - -	79136	5103 -25-MD-R

¹Replace only with part bearing the same color as the original part in your instrument.

Fig. & Index No.	Tektronix Part No.	Serial/Model No. Eff	Dscnt	Qty	1 2 3 4 5	Name & Description	Mfr	
							Code	Mfr Part Number
2-45	105-0112-00			1	.	DRUM,CAM SW:		105-0112-00
	213-0075-00			2	.	SETScrew:4-40 X 0.094 INCH,HEX SOC STL	000BK	OBD
-46	210-0405-00			1	.	NUT, PLAIN, HEX.:2-56 X 0.188 INCH, BRS	73743	2X12157-402
-47	210-0406-00			2	.	NUT, PLAIN, HEX.:4-40 X 0.188 INCH, BRS	73743	2X12161-402
-48	401-0061-00			1	.	BEARING,CAM SW:REAR	80009	401-0061-00
	105-0466-00			1	.	DRUM ASSY,CAM S:LOW FREQUENCY (ATTACHING PARTS)	80009	105-0466-00
-49	211-0116-00			4	.	SCR,ASSEM WSHR:4-40 X 0.312 INCH,PNH BRS - - - * - - -	83385	OBD
-50	200-0995-00			1	.	COVER,CAM SW: (ATTACHING PARTS)	80009	200-0995-00
-51	211-0022-00			2	.	SCREW,MACHINE:2-56 X 0.188 INCH,PNH STL	83385	OBD
-52	210-0001-00			2	.	WASHER,LOCK:INTL,0.092 ID X 0.18"OD,STL - - - * - - -	78189	1202-00-00-0541C
-53	407-0714-00	XB010181		1	.	BRACKET,CAM SW:	80009	407-0714-00
-54	214-1126-01 ¹			1	.	SPRING,FLAT:GREEN COLORED	80009	214-1126-01
	214-1126-02 ¹			1	.	SPRING,FLAT:RED COLORED	80009	214-1126-02
-55	214-1127-00			1	.	ROLLER,DETENT:0.125 DIA X 0.125 INCH L	80009	214-1127-00
-56	401-0058-00			1	.	BEARING,CAM SW:FRONT (ATTACHING PARTS)	80009	401-0058-00
-57	354-0219-00			1	.	RING,RETAINING:FOR 0.25 INCH SHAFT - - - * - - -	79136	5103-25-MD-R
-58	105-0109-00			1	.	DRUM, CAM SW:	80009	105-0109-00
	213-0075-00			2	.	SETScrew:4-40 X 0.094 INCH,HEX SOC STL	000BK	OBD
-59	210-0405-00			1	.	NUT, PLAIN, HEX.:2-56 X 0.188 INCH, BRS	73743	2X12157-402
-60	210-0406-00			2	.	NUT, PLAIN, HEX.:4-40 X 0.188 INCH, BRS	73743	2X12161-402
-61	401-0061-00			1	.	BEARING, CAM SW:REAR	80009	401-0061-00
-62	-----			1	.	RESISTOR,VAR:(SEE R535,S535 EPL) (ATTACHING PARTS)		
-63	210-0583-00			1	.	NUT,PLAIN,HEX.:0.25-32 X 0.312 INCH,BRS	73743	2X20224-402
-64	210-0046-00			1	.	WASHER, LOCK: INTL, 0.26 ID X 0.40" OD, STL - - - * - - -	78189	1214-05-00-0541C
-65	407-0553-00			1	.	BRKT,CMPNT MTG:	80009	407-0553-00
-66	670-1014-00	B010100	B029999	1	.	CKT BOARD ASSY:MAIN	80009	670-1014-00
	670-1014-01	B030000	B059999	1	.	CKT BOARD ASSY:MAIN	80009	670-1014-01
	670-1014-03	B060000	B069999	1	.	CKT BOARD ASSY:MAIN	80009	670-1014-03
	670-1014-04	B070000	B079999	1	.	CKT BOARD ASSY:MAIN	80009	670-1014-04
	670-1014-05	B080000	B115479	1	.	CKT BOARD ASSY:MAIN	80009	670-1014-05
	670-1014-06	B115480		1	.	CKT BOARD ASSY:MAIN (ATTACHING PARTS)	80009	670-1014-06
-67	211-0116-00	B010100	B099999	1	.	SCR,ASSEM WSHR:4-40 X 0.312 INCH,PNH BRS	83385	OBD
	211-0513-00	B100000		1	.	SCREW,MACHINE:6-32 X 0.625 INCH,PNH STL	83385	OBD
-68	210-0586-00	B010100	B099999	1	.	NUT,PLAIN,EXT W:4-40 X 0.25 INCH,STL	78189	211-041800-00
	210-0457-00	B100000		1	.	NUT,PLAIN,EXT W:6-32 X 0.312 INCH,STL	83385	OBD
-69	210-0863-00	XB100000		1	.	WSHR,LOOP CLAMP:FOR 0.50" WIDE CLAMP,STL	95987	C191
-70	343-0002-00	XB100000	B115479	1	.	CLAMP,LOOP:0.188 INCH DIA	95987	3-16-6B
	343-0003-00	B115480		1	.	CLAMP,LOOP:0.25 INCH DIA	95987	1-4 6R
-71	210-0413-00			1	.	NUT,PLAIN,HEX.:0.375-32 X 0.50 INCH,STL	73743	3145-402
-72	210-0840-00			1	.	WASHER,FLAT:0.39 ID X 0.562 INCH OD,STL - - - * - - -	89663	644R
-73	384-0448-00			1	.	SHAFT,EXTENSION:11.125 INCH LONG,PLASTIC	80009	384-0448-00
-74	376-0091-00			1	.	CPLG,SHAFT,FLEX:	99934	A-201-165
	213-0020-00	XB020160		4	.	SETScrew:6-32 X 0.125 INCH,HEX.SOC STL	70276	OBD
-75	131-0590-00			18	.	CONTACT,ELEC:0.71 INCH LONG	22526	47351
-76	342-0050-00	XB050000		15	.	INSULATOR, STDF:		342-0050-00
-77	351-0155-00			22	.	INSULATOR, STDF: CONNECTOR, DELRIN	80009	351-0155-00
-78	136-0235-00			4	.	SOCKET,PLUG-IN:6 CONTACT,ROUND	71785	133-96-12-062
-79	344-0154-00			4	.	CLIP, ELECTRICAL:FOR 0.25 INCH DIA FUSE	80009	344-0154-00
-80	136-0183-00			4	.	SOCKET,PLUG-IN:3 PIN,ROUND	80009	136-0183-00
-81	131-0566-00			2	.	LINK, TERM. CONNE:0.086 DIA X 2.375 INCH L	55210	L-2007-1
-82	337-1266-02			1	.	SHIELD,ELEC:	80009	337-1266-02
-83	214-0579-00			4	.	TERM.,TEST PT:BRS CD PL	80009	214-0579-00
-84	136-0235-01			1	.	SOCKET,PLUG-IN:6 CONTACT,ROUND	71785	133-96-92-067

¹Replace only with part bearing the same color as the original part in your instrument.

**PART NUMBER - NATIONAL STOCK NUMBER
CROSS REFERENCE INDEX**

<u>PART NUMBER</u>	<u>FSCM</u>	<u>NATIONAL STOCK NUMBER</u>	<u>PART NUMBER</u>	<u>FSCM</u>	<u>NATIONAL STOCK NUMBER</u>
BB2035	01121	5905-00-958-3830	CEATO-1241F	75042	5905-00-153-4435
BB2235	01121	5905-00-403-8837	CEATO-1272F	75042	5905-00-105-9724
BB2415	01121	5905-00-961-7730	CEATO-1500F	75042	5905-00-917-0576
BB3915	01121	5905-00-407-0085	CEATO-1501F	75042	5905-00-109-9848
BB5115	01121	5905-00-234-4374	CEATO-1541F	75042	5905-01-026-5084
CB1015	01121	5905-00-102-5294	CEATO-20R0F	75042	5905-00-177-7172
CB1035	01121	5905-00-909-3885	CEATO-2000F	75042	5905-00-998-1796
CB1045	01121	5905-00-959-1202	CEATO-2001F	75042	5905-00-922-9920
CB1055	01121	5905-00-116-8554	CEATO-2051F	75042	5905-00-724-5717
CB1235	01121	5905-00-989-7943	CEATO-2261F	75042	5905-00-102-6001
CB1545	01121	5905-00-904-5696	CEATO-2491F	75042	5905-00-021-6494
CB1855	01121	5905-00-800-8068	CEATO-2493F	75042	5905-00-051-1879
CB2025	01121	5905-00-102-5289	CEATO-3010F	75042	5905-00-078-1549
CB2045	01121	5905-00-136-7103	CEATO-3012F	75042	5905-01-017-8107
CB2225	01121	5905-00-909-3940	CEATO-3320F	75042	5905-00-021-6496
CB3635	01121	5905-00-136-8430	CEATO-3652F	75042	5905-00-419-2676
CB3645	01121	5905-00-141-0741	CEATO-3742F	75042	5905-00-441-7812
CB3915	01121	5905-00-907-4118	CEATO-4021F	75042	5905-00-922-9923
CB4335	01121	5905-00-122-0004	CEATO-4530F	75042	5905-00-433-7389
CB4735	01121	5905-00-960-0126	CEATO-4990F	75042	5905-00-922-9924
CB5105	01121	5905-00-909-3834	CEATO-4991F	75042	5905-00-922-9925
CB5125	01121	5905-00-911-3754	CEATO-5622F	75042	5905-00-997-9579
CB5135	01121	5905-00-136-3890	CEATO-8060F	75042	5905-00-233-5377
CB5625	01121	5905-00-909-3862	EB5625	01121	5905-00-121-9110
CB7535	01121	5905-00-916-7268	SE365	03508	5961-00-222-6190
CEATO-1002F	75042	5905-00-904-4409	SS22650	07263	5961-00-488-9927
CEATO-1003F	75042	5905-00-484-7475	SV2511	01121	5905-00-414-1101
CEATO-1012D	75042	5905-00-105-9709			
CEATO-1012F	75042	5905-00-893-1242	SZ50646	04713	5961-00-237-2353
CEATO-1101F	75042	5905-00-994-8457	WA1G040S202UA	01121	5905-00-400-3541

PART NUMBER NATIONAL STOCK NUMBER
CROSS REFERENCE INDEX

PART NUMBER	FSCM	NATIONAL STOCK NUMBER	PART NUMBER	FSCM	NATIONAL STOCK NUMBER
1N4152	07910	5961-00-899-8924	152-0185-00	80009	5961-00-936-7604
1N5567B	99942	5961-00-254-1621	152-0212-00	80009	5961-00-237-2353
1N963B	04713	5961-00-998-3666	152-0280-00	80009	5961-00-436-2890
1214-05-00-0541C	78189	5310-00-193-6731	152-0323-00	80009	5961-00-222-6190
129-0053-00	80009	5940-00-835-2060	152-0405-00	80009	5961-00-254-1621
131-0566-00	80009	5940-00-242-0676	189-4-5	74970	5910-00-958-3153
131-0589-00	80009	5999-00-275-0213	189-509-5	74970	5910-00-247-8600
131-0590-00	80009	5999-00-551-9434	189-6-5	74970	5910-00-834-4931
131-0604-00	80009	5999-00-173-9923	2N5308	03508	5961-00-146-8295
131-0608-00	80009	5999-00-551-9433	2N5859	04713	5961-00-448-6717
131-0622-00	80009	5999-01-022-6616	2X12161-402	73743	5310-00-407-4600
131-0679-00	80009	5935-00-236-7554	2X20224-402	73743	5310-00-158-5262
131-0707-00	80009	5999-00-396-6331	200-0103-00	80009	5999-00-914-3308
131-0792-00	80009	5999-01-023-1578	210-0046-00	80009	5310-00-841-8117
133-23-11-034	71785	5935-00-067-7311	210-0259-00	80009	5940-00-474-9824
133-96-12-062	71785	5935-00-814-2209	210-0457-00	80009	5310-00-841-8106
136-0183-00	80009	5935-00-938-4734	210-0583-00	80009	5310-00-006-8168
136-0220-00	80009	5935-00-067-7311	210-0586-00	80009	5310-00-836-3520
136-0235-00	80009	5935-00-814-2209	210-0940-00	80009	5310-00-158-5237
136-0263-03	80009	5999-00-394-0381	2104-04-00-2520N	78189	5940-00-847-3138
150-0046-00	80009	6240-00-933-5822	211-0101-00	80009	5305-00-492-2145
150-0048-01	80009	6240-00-060-2941	211-0116-00	80009	5305-00-005-8245
150-0057-01	80009	6240-00-183-0669	213-0020-00	80009	5305-00-005-8247
150D396X9010B2	56289	5910-00-833-5175	213-0153-00	80009	5305-00-283-1909
150D475X9035B2	56289	5910-00-177-4300	214-0579-00	80009	5940-00-935-8313
151-0219-00	80009	5961-00-488-9927	214-1127-00	80009	3110-00-442-8406
151-0228-00	80009	5961-00-401-6210	214-1136-00	80009	5930-01-020-6724
151-0260-00	80009	5961-00-493-1102	214-1139-02	80009	5360-00-480-3639
151-0261-00	80009	5961-00-689-1455	214-1139-03	80009	5360-00-447-8721
151-1027-00	80009	5961-00-438-6453	214-1190-00	80009	6625-01-066-3336

**PART NUMBER – NATIONAL STOCK NUMBER
CROSS REFERENCE INDEX**

PART NUMBER	FSCM	NATIONAL STOCK NUMBER	PART NUMBER	FSCM	NATIONAL STOCK NUMBER
28JR168-1	24931	5935-00-236-7554	310-0583-00	80009	5905-00-969-8991
281-0081-00	80009	5910-00-834-4931	311-0467-00	80009	5905-00-472-7323
281-0092-00	80009	5910-00-403-8872	311-0532-00	80009	5905-00-472-7773
281-0093-00	80009	5910-00-983-2623	311-0605-00	80009	5905-00-481-8441
281-0114-00	80009	5910-00-065-9821	311-0609-00	80009	5905-00-431-2984
281-0122-00	80009	5910-00-013-9658	311-0635-00	80009	5905-00-497-4330
281-0528-00		5910-00-765-0380	311-0704-00	80009	5905-00-498-1330
281-0534-00	80009	5910-00-978-2441	311-0827-00	80009	5905-00-414-1101
281-0544-00	80009	5910-00-725-1700	311-1258-00	80009	5905-00-434-5414
281-0613-00	80009	5910-00-018-1241	311-1260-00	80009	5905-00-434-5416
283-0000-00	80009	5910-00-688-8702	311-1261-00	80009	5905-00-433-4372
283-0002-00	80009	5910-00-721-2030	315-0101-00	80009	5905-00-102-5294
283-0058-00	80009	5910-00-089-7509	315-0103-00	80009	5905-00-434-5442
283-0059-00	80009	5910-00-932-7113	315-0104-00	80009	5905-00-434-5443
283-0080-00	80009	5910-00-931-7067	315-0123-00	80009	5905-00-445-3826
283-0092-00	80009	5910-00-848-6590	315-0151-00	80009	5905-00-577-9598
283-0111-00	80009	5910-00-436-7154	315-0202-00	80009	5905-00-445-3739
283-0594-00	80009	5910-00-066-0061	315-0204-00	80009	5905-00-445-3762
283-0604-00	80009	5910-00-064-9433	315-0222-00	80009	5905-00-436-9299
283-0617-00	80009	5910-00-491-2367	315-0473-00	80009	5905-00-437-0164
285-0627-00	80009	5910-00-014-6565	315-0510-00	80009	5905-00-437-0272
285-0702-00		5910-00-243-2218	315-0512-00	80009	5905-00-437-0283
285-0703-00	80009	5910-00-947-6978	315-0562-00	80009	5905-00-437-0423
3-16-6B	95987	5340-00-417-4927	321-0098-01	80009	5905-00-441-7807
301-000C0J0339C	72982	5910-00-978-2441	321-0114-00	80009	5905-00-405-7804
301-000U2M0820K	72982	5910-00-765-0380	321-0126-00	80009	5905-00-998-1796
301-0470-00	80009	5905-00-464-1844	321-0127-01	80009	5905-00-879-7833
307-0181-00	80009	5905-00-551-9251	321-0147-00	80009	5905-00-405-7785
308-0495-00	80009	5905-00-401-6651	321-0164-00	80009	5905-00-922-9924

SECTION 9

PART NUMBER- NATIONAL STOCK NUMBER
CROSS REFERENCE INDEX

PART NUMBER	FSCM	NATIONAL STOCK NUMBER	PART NUMBER	FSCM	NATIONAL STOCK NUMBER
321-0184-00	80009	5905-00-405-7962	376-0029-00	80009	3010-00-498-7454
321-0197-00	80009	5905-00-434-5060	410P111	56289	5910-00-243-2218
321-0210-00	80009	5905-00-109-9848	46221	22526	5999-01-023-1578
321-0222-00	80009	5905-00-426-7707	46241	22526	5999-01-022-6616
321-0227-00	80009	5905-00-426-7720	47350	22526	5999-00-275-0213
321-0231-00	80009	5905-00-021-6494	47357	22526	5999-00-551-9433
321-0260-00	80009	5905-00-922-9925	47439	22526	5999-00-396-6331
321-0289-00	80009	5905-00-434-5068	538-011E2P094R	72982	5910-00-983-2624
321-0299-00	80009	5905-00-105-9724			
321-0335-00	80009	5905-00-426-7771	62-56-3	80740	5905-00-497-4330
321-0344-00	80009	5905-00-441-7812	683AS15	08806	6240-00-062-6173
321-0385-00	80009	5905-00-426-7847	811-546E103Z	72982	5910-00-721-2030
321-0614-00	80009	5905-00-893-1242	8131N147W5R273K	72982	5910-00-089-7509
321-0763-07	80009	5905-00-441-7810	86250-2	00779	5999-00-394-0381
321-1068-01	80009	5905-00-441-7828			
321-1166-01	80009	5905-00-441-7829			
321-1231-01	80009	5905-00-441-7826			
344-0154-00	80009	5999-00-465-9987			
348-0115-00	80009	5325-00-232-9217			
348-0235-00	80009	5999-00-434-2894			
352-0067-00	80009	6250-00-089-7366			
352-0068-00	80009	6625-00-980-9301			
352-0136-00	80009	5920-00-401-6790			
352-0169-00	80009	5935-00-597-5054			
352-0198-00	80009	5935-00-597-5055			
355-0507-00	80009	5307-00-529-8873			
358-0216-00	80009	5355-00-016-8665			
366-1057-00	80009	5355-00-765-3932			
366-1077-00	80009	5355-00-419-4045			

CALIBRATION TEST EQUIPMENT REPLACEMENT

Calibration Test Equipment Chart

This chart compares TM 500 product performance to that of older Tektronix equipment. Only those characteristics where significant specification differences occur, are listed. In some cases the new instrument may not be a total functional replacement. Additional support instrumentation may be needed or a change in calibration procedure may be necessary.

Comparison of Main Characteristics

DM 501 replaces 7D13		
PG 501 replaces 107	PG 501 - Risetime less than 3.5 ns into 50 Ω.	107 - Risetime less than 3.0 ns into 50 Ω.
108	PG 501 - 5 V output pulse; 3.5 ns Risetime.	108 - 10 V output pulse; 1 ns Risetime.
111	PG 501 - Risetime less than 3.5 ns; 8 ns Pretrigger pulse delay.	111 - Risetime 0.5 ns; 30 to 250 ns Pretrigger Pulse delay.
114	PG 501 - ±5 V output.	114 - ±10 V output. Short proof output.
115	PG 501 - Does not have Paired, Burst, Gated, or Delayed pulse mode; ±5 V dc Offset. Has ±5 V output.	115 - Paired, Burst, Gated, and Delayed pulse mode; ±10 V output. Short-proof output.
PG 502 replaces 107		
108	PG 502 - 5 V output	108 - 10 V output.
111	PG 502 - Risetime less than 1 ns; 10 ns Pretrigger pulse delay.	111 - Risetime 0.5 ns; 30 to 250 ns Pretrigger pulse delay.
114	PG 502 - ±5 V output	114 - ±10 V output. Short proof output.
115	PG 502 - Does not have Paired, Burst, Gated, Delayed & Undelayed pulse mode; Has ±5 V output.	115 - Paired, Burst, Gated, Delayed & Undelayed pulse mode; ±10 V output. Short-proof output.
2101	PG 502 - Does not have Paired or Delayed pulse. Has ±5 V output.	2101 - Paired and Delayed pulse; 10 V output.
PG 506 replaces 106	PG 506 - Positive-going trigger output signal at least 1 V; High Amplitude output, 60 V.	106 - Positive and Negative-going trigger output signal, 50 ns and 1 V; High Amplitude output, 100 V.
067-0502-01	PG 506 - Does not have chopped feature.	502-01 - Comparator output can be alternately chopped to a reference voltage.
SG 503 replaces 190, 190A, 190B, 191, 067-0532-01	SG 503 - Amplitude range 5 mV to 5.5 V p-p. SG 503 - Frequency range 250 kHz to 250 MHz. SG 503 - Frequency range 250 kHz to 250 MHz.	190B - Amplitude range 40 mV to 10 V p-p. 191 - Frequency range 350 kHz to 100 MHz. 532-01 - Frequency range 65 MHz to 500 MHz.
TG 501 replaces 180, 180A	TG 501 - Marker outputs, 5 sec to 1 ns. Sinewave available at 5, 2, and 1 ns. Trigger output - slaved to marker output from 5 sec through 100 ns. One time-mark can be generated at a time.	180A - Marker outputs, 5 sec to 1 μs. Sinewave available at 20, 10, and 2 ns. Trigger pulses 1, 10, 100 Hz; 1, 10, and 100 kHz. Multiple time-marks can be generated simultaneously.
181	TG 501 - Marker outputs, 5 sec to 1 ns. Sinewave available at 5, 2, and 1 ns.	181 - Marker outputs, 1, 10, 100, 1000, and 10,000 μs, plus 10 ns sinewave.
184	TG 501 - Marker outputs, 5 sec to 1 ns. Sinewave available at 5, 2, and 1 ns. Trigger output - slaved to marker output from 5 sec through 100 ns. One time-mark can be generated at a time.	184 - Marker outputs, 5 sec to 2 ns. Sinewave available at 50, 20, 10, 5, and 2 ns. Separate trigger pulses of 1 and .1 sec; 10, 1, and .1 ms; 10 and 1 μs. Marker amplifier provides positive or negative time marks of 25 V min. Marker intervals of 1 and .1 sec; 10, 1, and .1 ms; 10 and 1 μs.
2901	TG 501 - Marker outputs, 5 sec to 1 ns. Sinewave available at 5, 2, and 1 ns. Trigger output - slaved to marker output from 5 sec through 100 ns. One time-mark can be generated at a time.	2901 - Marker outputs, 5 sec to 0.1 μs. Sinewave available to 50, 10, and 5 ns. Separate trigger pulses, from 5 sec to 0.1 μs. Multiple time-marks can be generated simultaneously.

NOTE: All TM 500 generator outputs are short-proof. All TM 500 plug-in instruments require TM 500-Series Power Module.

APPENDIX A

REFERENCES

-
- DA Pam 310-4 Index of Technical Publications: Technical Manuals, Technical Bulletins, Supply Manuals (Types 7, 8, and 9), Supply Bulletins, and Lubrication Orders.
- DA Pam 316-7 US Army Equipment Index of Modification Work Orders.
- TM 43-0118 Field Instructions for Painting and Preserving Electronics Command Equipment Including Camouflage Pattern Painting of Electrical Equipment Shelters.
- TM 38-750 The Army Maintenance Management System (TAMMS).
- TM 750-244-2 Procedures for Destruction of Electronics Materiel to Prevent Enemy Use (Electronics Command).

APPENDIX D
MAINTENANCE ALLOCATION

Section I. INTRODUCTION

D-1. General

This appendix provides a summary of the maintenance operations for AM-6786/U. It authorizes categories of maintenance for specific maintenance functions on repairable items and components and the tools and equipment required to perform each function. This appendix may be used as an aid in planning maintenance operations.

D-2. Maintenance Function

Maintenance functions will be limited to and defined as follows:

To determine the serviceability of an item by comparing its physical, mechanical, and/or electrical characteristics with established standards through examination.

b. Test. To verify serviceability and to detect incipient failure by measuring the mechanical or electrical characteristics of an item and comparing those characteristics with prescribed standards.

c. Service. Operations required periodically to keep an item in proper operating condition, i.e., to clean (decontaminate), to preserve, to drain, to paint, or to replenish fuel, lubricants, hydraulic fluids, or compressed air supplies.

d. Adjust. To maintain, within prescribed limits, by bringing into proper or exact position, or by setting the operating characteristics to the specified parameters.

e. Align. To adjust specified variable elements of an item to bring about optimum or desired performance.

f. Calibrate. To determine and cause corrections to be made or to be adjusted on instruments or test measuring and diagnostic equipment used in precision measurement. Consists of comparisons of two instruments, one of which is a certified standard of known accuracy, to detect and adjust any discrepancy in the accuracy of the instrument being compared.

g. Install. The act of emplacing, seating, or fixing into position an item, part, module (component or assembly) in a manner to allow the proper functioning of the equipment or system.

h. Replace. The act of substituting a serviceable like type, part, sub-assembly, or module (component or assembly) for an unserviceable "counterpart."

i. Repair. The application of maintenance services (inspect, test, service, adjust, align, calibrate, replace) or other maintenance actions (welding, grinding, riveting, straightening, facing, remachining, or resurfacing) to restore serviceability to an item by correcting specific damage, fault, malfunction, or failure in a part, subassembly, module (component or assembly), end item, or system.

j. Overhaul. That maintenance effort (service/action) necessary to restore an item to a completely serviceable/operational condition as prescribed by maintenance standards (i.e., DMWR) in appropriate technical publications. Overhaul is normally the highest degree of maintenance performed by the Army. Overhaul does not normally return an item to like new condition.

k. Rebuild. Consists of those services/actions necessary for the restoration of unserviceable equipment to a like new condition in accordance with original manufacturing standards. Rebuild is the highest degree of materiel maintenance applied to Army equipment. The rebuild operation includes the act of returning to zero those age measurements (hours, miles, etc.) considered in classifying Army equipments/components.

D-3. Column Entries

a. Column 1, Group Number. Column 1 lists group numbers, the purpose of which is to identify components, assemblies, subassemblies, and modules with the next higher assembly.

b. Column 2, Component/Assembly. Column 2 contains the noun names of components, assemblies, subassemblies, and modules for which maintenance is authorized.

c. Column 3, Maintenance Functions. Column 3 lists the functions to be performed on the item listed in column 2. When items are listed without maintenance functions, it is solely for purpose of having the group numbers in the MAC and RPSTL coincide.

d. Column 4, Maintenance Category. Column 4 specifies, by the listing of a "work time" figure in the appropriate subcolumn(s), the lowest level of maintenance authorized to perform the function listed in column 3. This figure represents the active time required to perform that maintenance function at the indicated category of maintenance. If the number or complexity of the tasks within the listed maintenance function vary at different maintenance categories, appropriate "work time" figures will be shown for each category. The number of task-hours specified by the "work time" figure represents the average time required to restore an item (assembly, subassembly, component, module, end item or system) to a serviceable condition under typical field operating conditions. This time includes preparation time, troubleshooting time, and quality assurance/quality control time in addition to the time required to perform the specific tasks identified for the maintenance functions authorized in the maintenance allocation chart. Subcolumns of column 4 are as follows:

C - Operator/Crew

- O - Organizational
- F - Direct Support
- H - General Support
- D - Depot

e. Column 5, Tools and Equipment. Column 5 specifies by code, those tool sets (not individual tools) and special tools, test, and support equipment required to perform the designated function.

f. Column 6, Remarks. Column 6 contains an alphabetic code which leads to the remark in section IV, Remarks, which is pertinent to the item opposite the particular code.

D-4. Tool and Test Equipment Requirements (Sect. III)

a. Tool or Test Equipment Reference Code. The numbers in this column coincide with the numbers used in the tools and equipment column of the MAC. The numbers indicate the applicable tool or test equipment for the maintenance functions.

b. Maintenance Category. The codes in this column indicate the maintenance category allocated the tool or test equipment.

c. Nomenclature. This column lists the noun name and nomenclature of the tools and test equipment required to perform the maintenance functions,

d. National/NATO Stock Number. This column lists the National/NATO stock number of the specific tool or test equipment.

e. Tool Number. This column lists the manufacturer's part number of the tool followed by the Federal Supply Code for manufacturers.

D-5. Remarks (Sect. IV)

a. Reference Code. This code refers to the appropriate item in section II, column 6.

b. Remarks. This column provides the required explanatory information necessary to clarify items appearing in section II.

SECTION II MAINTENANCE ALLOCATION CHART
FOR
DIFFERENTIAL AMPLIFIER AM-6786/U

(1) GROUP NUMBER	(2) COMPONENT/ASSEMBLY	(3) MAINTENANCE FUNCTION	(4) MAINTENANCE CATEGORY					(5) TOOLS AND EQPT.	(6) REMARKS
			C	O	F	H	D		
01	DIFFERENTIAL AMPLIFIER AM-6786/U	Inspect Service Test Test Adjust Align Repair Overhaul		0.5 1.0		1.0 1.0 1.0		5 thru 5 thru 1,2,4 thru 3.0	

SECTION III TOOL AND TEST EQUIPMENT REQUIREMENTS
 FOR
 DIFFERENTIAL AMPLIFIER AM-6786/U

TOOL OR TEST EQUIPMENT REF CODE	MAINTENANCE CATEGORY	NOMENCLATURE	ATIONAL/NATO STOCK NUMBER	TOOL NUMBER
1	H,D	OSCILLOSCOPE AN/USM-281C	625-00-106-9622	
2	H,D	MULTIMETER AN/USM-223	625-00-999-7465	
3	H,D	TEST SET, TRANSISTOR TS-1836D/U	625-00-138-7320	
4	H,D	TOOL KIT, ELECTRONIC EQUIPMENT TK-105/G	180-00-610-8177	
5	O	TOOL KIT, ELECTRONIC EQUIPMENT TK-101/G	180-00-064-5178	

RECOMMENDED CHANGES TO EQUIPMENT TECHNICAL MANUALS



SOMETHING WRONG WITH THIS MANUAL?

THEN... JOT DOWN THE DOPE ABOUT IT ON THIS FORM, TEAR IT OUT, FOLD IT AND DROP IT IN THE MAIL!

FROM: (YOUR UNIT'S COMPLETE ADDRESS)

Commander
Stateside Army Depot
ATTN: AMSTA-US
Stateside, N.J. 07703

DATE 10 July 1975

PUBLICATION NUMBER

TM 11-5840-340-12

DATE

23 Jan 74

TITLE

Radar Set AN/SPS-76

BE EXACT... PIN-POINT WHERE IT IS

IN THIS SPACE TELL WHAT IS WRONG AND WHAT SHOULD BE DONE ABOUT IT:

PAGE NO.	PARA-GRAPH	FIGURE NO.	TABLE NO.
2-25	2-28		
3-10	3-3		3-1
5-6	5-8		
		FO3	

Recommend that the installation antenna alignment procedure be changed throughout to specify a 2° IFF antenna lag rather than 1°.

REASON: Experience has shown that with only a 1° lag, the antenna servo system is too sensitive to wind gusting in excess of 7 knots, and has a tendency to rapidly accelerate and decelerate as it hunts, causing strain to the drive train. Hunting is minimized by adjusting the lag to 2° without degradation of operation.

Item 5, Functions column. Change "2 db" to "3db."

REASON: The adjustment procedure for the TRANS POWER FAULT indicator calls for a 3 db (500 watts) adjustment to light the TRANS POWER FAULT indicator.

Add new step f.1 to read, "Replace cover plate removed in step e.1, above."

REASON: To replace the cover plate.

Zone C 3. On J1-2, change "+24 VDC to "+5 VDC."

REASON: This is the output line of the 5 VDC power supply. + 24 VDC is the input voltage.

TEAR ALONG DOTTED LINE

TYPED NAME, GRADE OR TITLE, AND TELEPHONE NUMBER

SSG I. M. DeSpirito 999-1776

SIGN HERE:

SSG I. M. DeSpirito

DA FORM 2028-2
1 AUG 74

P.S.--IF YOUR OUTFIT WANTS TO KNOW ABOUT YOUR MANUAL "FIND" MAKE A CARBON COPY OF THIS AND GIVE IT TO YOUR HEADQUARTERS.

RECOMMENDED CHANGES TO EQUIPMENT TECHNICAL MANUALS



SOMETHING WRONG WITH THIS MANUAL?

THEN... JOT DOWN THE DOPE ABOUT IT ON THIS FORM, TEAR IT OUT, FOLD IT AND DROP IT IN THE MAIL!

FROM: (YOUR UNIT'S COMPLETE ADDRESS)

DATE

PUBLICATION NUMBER

TM 11-6625-2749-14&P

DATE

10 Oct 79

TITLE

AM-6786/U

BE EXACT... PIN-POINT WHERE IT IS

PAGE NO.

PARA-GRAPH

FIGURE NO.

TABLE NO.

IN THIS SPACE TELL WHAT IS WRONG AND WHAT SHOULD BE DONE ABOUT IT:

TEAR ALONG DOTTED LINE

TYPED NAME, GRADE OR TITLE, AND TELEPHONE NUMBER

SIGN HERE:

DA FORM 2028-2
1 AUG 74

P.S.--IF YOUR OUTFIT WANTS TO KNOW ABOUT YOUR MANUAL "FIND," MAKE A CARBON COPY OF THIS AND GIVE IT TO YOUR HEADQUARTERS.

FILL IN YOUR
UNIT'S ADDRESS

FOLD BACK

DEPARTMENT OF THE ARMY

OFFICIAL BUSINESS

PENALTY FOR PRIVATE USE, \$300

POSTAGE AND FEES PAID
DEPARTMENT OF THE ARMY
DOD-314



Commander
US Army Communications and
Electronics Materiel Readiness Command
ATTN: DRSEL-ME-MQ
Fort Monmouth, New Jersey 07703

TEAR ALONG DOTTED LINE

FOLD BACK

RECOMMENDED CHANGES TO EQUIPMENT TECHNICAL MANUALS



THEN... JOT DOWN THE DOPE ABOUT IT ON THIS FORM, TEAR IT OUT, FOLD IT AND DROP IT IN THE MAIL!

SOMETHING WRONG WITH THIS MANUAL?

FROM: (YOUR UNIT'S COMPLETE ADDRESS)

DATE

PUBLICATION NUMBER

TM 11-6625-2749-1L&P

DATE

10 Oct 79

TITLE

BE EXACT. . . PIN-POINT WHERE IT IS

IN THIS SPACE TELL WHAT IS WRONG AND WHAT SHOULD BE DONE ABOUT IT:

PAGE NO.

PARA-GRAPH

FIGURE NO.

TABLE NO.

TEAR ALONG DOTTED LINE

TYPED NAME, GRADE OR TITLE, AND TELEPHONE NUMBER

SIGN HERE:

DA FORM 2028-2
1 AUG 74

P.S.--IF YOUR OUTFIT WANTS TO KNOW ABOUT YOUR MANUAL "FIND," MAKE A CARBON COPY OF THIS AND GIVE IT TO YOUR HEADQUARTERS.

FILL IN YOUR
UNIT'S ADDRESS

FOLD BACK

DEPARTMENT OF THE ARMY

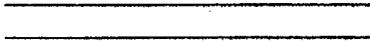

OFFICIAL BUSINESS

PENALTY FOR PRIVATE USE, \$300

POSTAGE AND FEES PAID
DEPARTMENT OF THE ARMY
DOD-314



Commander
US Army Communications and
Electronics Materiel Readiness Command
ATTN: DRSEL-ME-MQ
Fort Monmouth, New Jersey 07703

TEAR ALONG DOTTED LINE

FOLD BACK

RECOMMENDED CHANGES TO EQUIPMENT TECHNICAL MANUALS



SOMETHING WRONG WITH THIS MANUAL?

THEN... JOT DOWN THE DOPE ABOUT IT ON THIS FORM, TEAR IT OUT, FOLD IT AND DROP IT IN THE MAIL!

FROM: (YOUR UNIT'S COMPLETE ADDRESS)

DATE

PUBLICATION NUMBER

TM 11-6625-2749-14&P

DATE

10 Oct 79

TITLE

BE EXACT... PIN-POINT WHERE IT IS

IN THIS SPACE TELL WHAT IS WRONG AND WHAT SHOULD BE DONE ABOUT IT:

PAGE NO.

PARA-GRAPH

FIGURE NO.

TABLE NO.

TEAR ALONG DOTTED LINE

TYPED NAME, GRADE OR TITLE, AND TELEPHONE NUMBER

SIGN HERE:

DA FORM 2028-2
1 AUG 74

P.S.--IF YOUR OUTFIT WANTS TO KNOW ABOUT YOUR MANUAL "FIND," MAKE A CARBON COPY OF THIS AND GIVE IT TO YOUR HEADQUARTERS.

FILL IN YOUR
UNIT'S ADDRESS

FOLD BACK

DEPARTMENT OF THE ARMY

OFFICIAL BUSINESS

PENALTY FOR PRIVATE USE, \$300

POSTAGE AND FEES PAID
DEPARTMENT OF THE ARMY
DOD-314



Commander
US Army Communications and
Electronics Materiel Readiness Command
ATTN: DRSEL-ME-MQ
Fort Monmouth, New Jersey 07703

FOLD BACK

TEAR ALONG DOTTED LINE

By Order of the Secretary of the Army:

E. C. MEYER
General, United States Army
Chief of Staff

Official:

J. C. PENNINGTON
Major General, United States Army
The Adjutant General

DISTRIBUTION:

Active Army:

TSG (1)
USAARENBD (1)
USAINSCOM (2)
TRADOC (2)
DARCOM (1)
TECOM (2)
OS Maj Comd (2)
USACC (2)
HISA (Ft Monmouth) (21)
Ft Gillem (10)
Ft Carson (5)
Ft Richardson (CERCOM Ofc) (1)
Ft Huachuca (5)
Svc Colleges (1)
USASIGS (10)
Armies (1)

WSMR (1)
USAERDAA (1)
USAERDAW (1)
Army Dep (1) except:
LBAD (10)
SAAD (30)
TOAD (14)
SHAD (3)
USA Dep (1)
Sig Sec USA Dep (1)
Units org under fol TOE:
29-134 (1)
29-136 (1)
29-207 (2)
29-610 (2)

NG: None.

USAR: None.

For explanation of abbreviations used, see AR 310-50.

