

TEKTRONIX®

**7A13
DIFFERENTIAL
COMPARATOR**

SN B200000-up

INSTRUCTION MANUAL

Tektronix, Inc.
P.O. Box 500
Beaverton, Oregon 97077

Serial Number _____

WARRANTY

All TEKTRONIX instruments are warranted against defective materials and workmanship for one year. Any questions with respect to the warranty should be taken up with your TEKTRONIX Field Engineer or representative.

All requests for repairs and replacement parts should be directed to the TEKTRONIX Field Office or representative in your area. This will assure you the fastest possible service. Please include the instrument Type Number or Part Number and Serial Number with all requests for parts or service.

Specifications and price change privileges reserved.

Copyright © 1975 by Tektronix, Inc., Beaverton, Oregon. Printed in the United States of America. All rights reserved. Contents of this publication may not be reproduced in any form without permission of Tektronix, Inc.

U.S.A. and foreign TEKTRONIX products covered by U.S. and foreign patents and/or patents pending.

TEKTRONIX is a registered trademark of Tektronix, Inc.

TABLE OF CONTENTS

SECTION 1	SPECIFICATION	Page
	Introduction	1-1
	Electrical Characteristics	1-1
	System Characteristics	1-4
	Environmental Characteristics	1-4
SECTION 2	OPERATING INSTRUCTIONS	
	Introduction	2-1
	Front Panel Description	2-1
	Test Setup Chart	2-2
	Familiarization Procedure	2-2
	General Operating Information	2-5
SECTION 3	CIRCUIT DESCRIPTION	
	Introduction	3-1
	Block Diagram Description	3-1
	Detailed Circuit Description	3-3
SECTION 4	MAINTENANCE	
	Preventive Maintenance	4-1
	Troubleshooting	4-2
	Corrective Maintenance	4-8
SECTION 5	PERFORMANCE CHECK/CALIBRATION	
	Introduction	5-1
	Test Equipment Required	5-1
	Short-Form Performance Check/Calibration Procedure and Index	5-5
	Performance Check/Calibration Procedure	5-8
SECTION 6	ELECTRICAL PARTS LIST	
	Abbreviations and Symbols	
	Parts Ordering Information	
SECTION 7	DIAGRAMS AND CIRCUIT BOARD ILLUSTRATIONS	
	Symbols and Reference Designators	
	Voltage and Waveform Conditions	
SECTION 8	MECHANICAL PARTS LIST	
	Mechanical Parts List Information	
	Index of Mechanical Parts Illustrations	
	Mechanical Parts List	
	Accessories	
CHANGE INFORMATION		

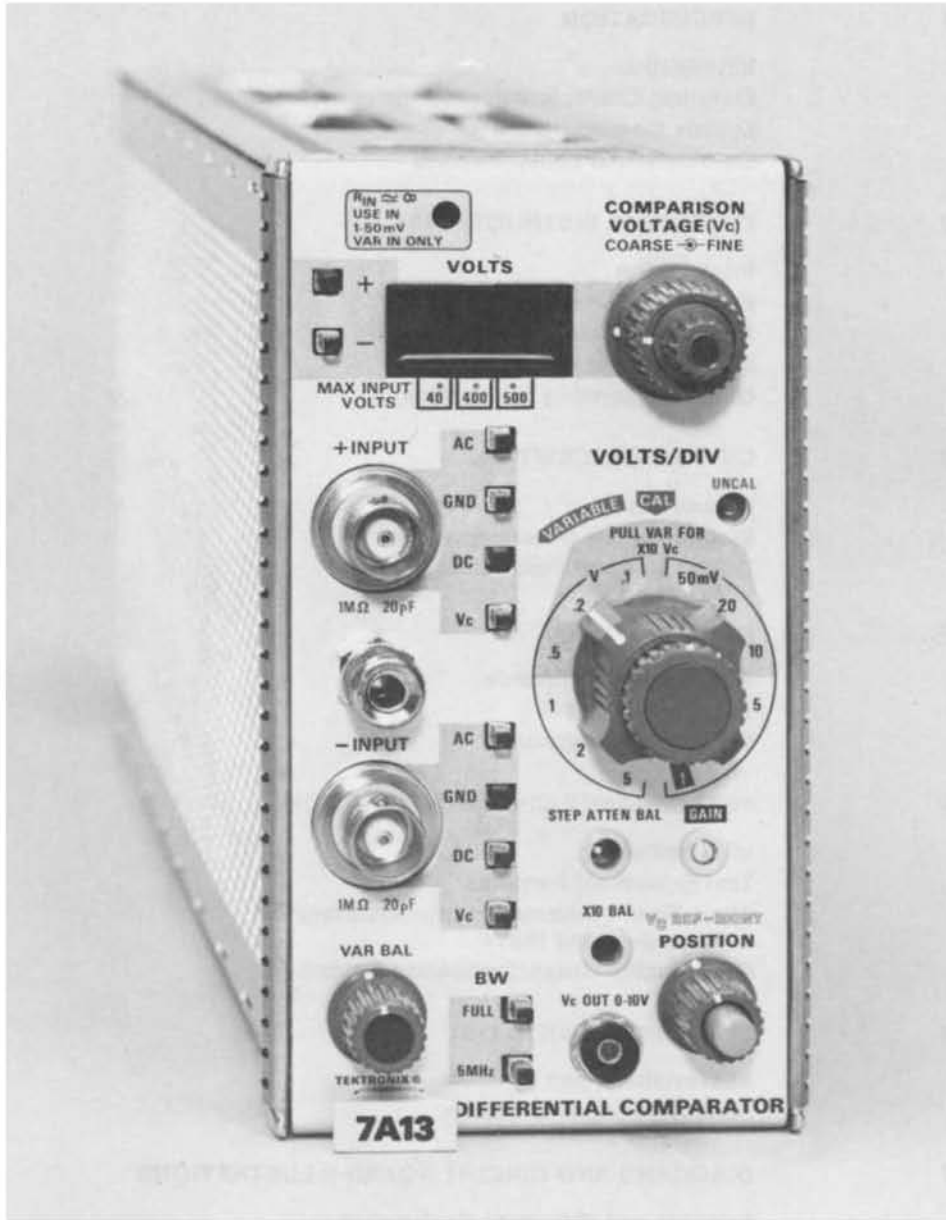

Fig. 1-1. 7A13 Differential Comparator.

7A13 (SN B200000-up)

SPECIFICATION

Introduction

The 7A13 Vertical Plug-In is a DC coupled differential comparator with excellent common-mode rejection and medium gain characteristics for medium level applications. The 7A13 is designed for use in Tektronix 7000 series oscilloscopes. It may be used as a differential input preamplifier or conventional preamplifier in addition to its use as a comparator.

In the differential input mode, the dynamic range allows the application of common-mode signals up to +10 or -10 volts to be applied to the unit without attenuation. Common-mode rejection ratio of at least 20,000:1 at DC to 100 kHz permits measurements of differential signals less than 1 mV in amplitude on 10 volt common-mode signals.

When used as a differential comparator, the 7A13 has an effective offset range of 10,000 divisions.

Electrical Characteristics

The electrical characteristics described in Table 1-1 are valid over the stated environmental range of instruments calibrated at an ambient temperature of +20°C to +30°C and after a 20-minute warmup period unless otherwise noted.

TABLE 1-1

ELECTRICAL CHARACTERISTICS

Characteristic	Performance Requirement
Deflection Factor (VOLTS/DIV)	
Calibrated Range	1 mV/Div to 5 V/Div, 12 steps in a 1, 2, 5 sequence
Gain Ratio Accuracy	Within 1.5% of GAIN adjusted at 1 mV/Div
Uncalibrated (Variable)	Continuously variable: extends deflection factor to at least 12.5 V/Div

TABLE 1-1 (cont)

Characteristic	Performance Requirement
Common Mode Signal Range 1 mV/Div to 50 mV/Div;	At least +10 V and -10 V
X10 V _c In 10 mV/Div to 50 mV/Div; X10 V _c Out	At least +100 V and -100 V
0.1 V/Div to 0.5 V/Div; X10 V _c In	
0.1 V/Div to 0.5 V/Div; X10 V _c Out	At least +500 V and -500 V
1 V/Div to 5 V/Div X10 V _c In	At least +500 V and -500 V
Frequency Response (8 Div Reference) FULL Bandwidth Upper Limit	See Table 1-4, System Characteristics
AC (Capacitive) Coupled Input Lower Bandwidth Frequency	10 Hz or less
5 MHz Bandwidth	DC to 5 MHz within 500 kHz
Overdrive Recovery (1X Attenuator at 1 mV/Div)	Recovers to within 2 mV in 1 μs (and 1 mV in 0.1 ms) after a pulse of +10 V or -10 V, or less, regardless of pulse duration.

Specification—7A13 (SN B200000-up)

TABLE 1-1 (cont)

Characteristic	Performance Requirement
Common Mode Rejection Ratio 1 mV/Div to 50 mV/Div X10 V _C In DC to 100 kHz	See Fig. 1-2. At least 20,000:1, 20 V P-P or less test signal
100 kHz to 1 MHz	At least 10,000:1, 10 V P-P or less test signal
1 MHz to 20 MHz	Decreases to 500:1 at 10 MHz with 1 V P-P, then 200:1 at 20 MHz at 1 V P-P. See Fig. 1-2.
10 mV/Div to 50 mV/Div; X10 V _C Out;	
0.1 V/Div to 5 V/Div; X10 V _C In or Out	
DC to 10 kHz	At least 2,000:1
AC Coupled at 60 Hz	At least 500:1
Maximum Input Voltage DC (Direct) Coupled DC + Peak AC 1 mV/Div to 50 mV/Div; X10 V _C In	40 VDC, 40 V Peak AC, 1 kHz or less
10 mV/Div to 50 mV/Div; X10 V _C Out	400 VDC, 400 V Peak AC, 1 kHz or less
0.1 V/Div to 0.5 V/Div; X10 V _C In	
0.1 V/Div to 0.5 V/Div; X10 V _C Out	500 VDC, 500 V Peak AC, 1 kHz or less
1 V/Div to 5 V/Div; X10 V _C In	
AC (Capacitive Coupled Input	500 VDC

TABLE 1-1 (cont)

Characteristic	Performance Requirement
Input R and C Resistance	1 MΩ ±0.15%
Capacitance	Approximately 20.0 pF
R and C Product	Within ±1% between all deflection factors.
Maximum Gate Current 0°C to +35°C Both Inputs	0.2 nA or less (0.2 Div at 1 mV/Div)
+35°C to +50°C Both Inputs	2 nA or less (2 Div at 1 mV/Div)
DC Drift Drift With Time (Ambient Temperature and Line Voltage Constant)	
Short Term	1 mV P-P or less or 0.1 Div or less (whichever is greater) any 1 minute interval within 1 hour after 20 minutes from turn-on.
Long Term	1 mV P-P or less or 0.1 Div (whichever is greater) during any hour after the first hour and 20 minutes from turn-on.
Drift With Ambient Temperature Line Voltage Constant)	2 mV/10°C or less, 0.2 Div/10°C or less (whichever is greater)
Amplifier Crosstalk	1% or less shift within 20 ns of step of fast rise squarewave when switching undriven input from GND to AC or DC
Displayed Noise Tangentially Measured)	400 μV or less at 1 mV/Div in Type 7700-Series indicator oscilloscope
Comparison Voltage Range	0 V to ±10 V
Accuracy	± (0.1% of setting +3 mV)
Electrical Zero	0.5 mV or less
V _C OUT Resistance	2 kΩ to 5.5 kΩ

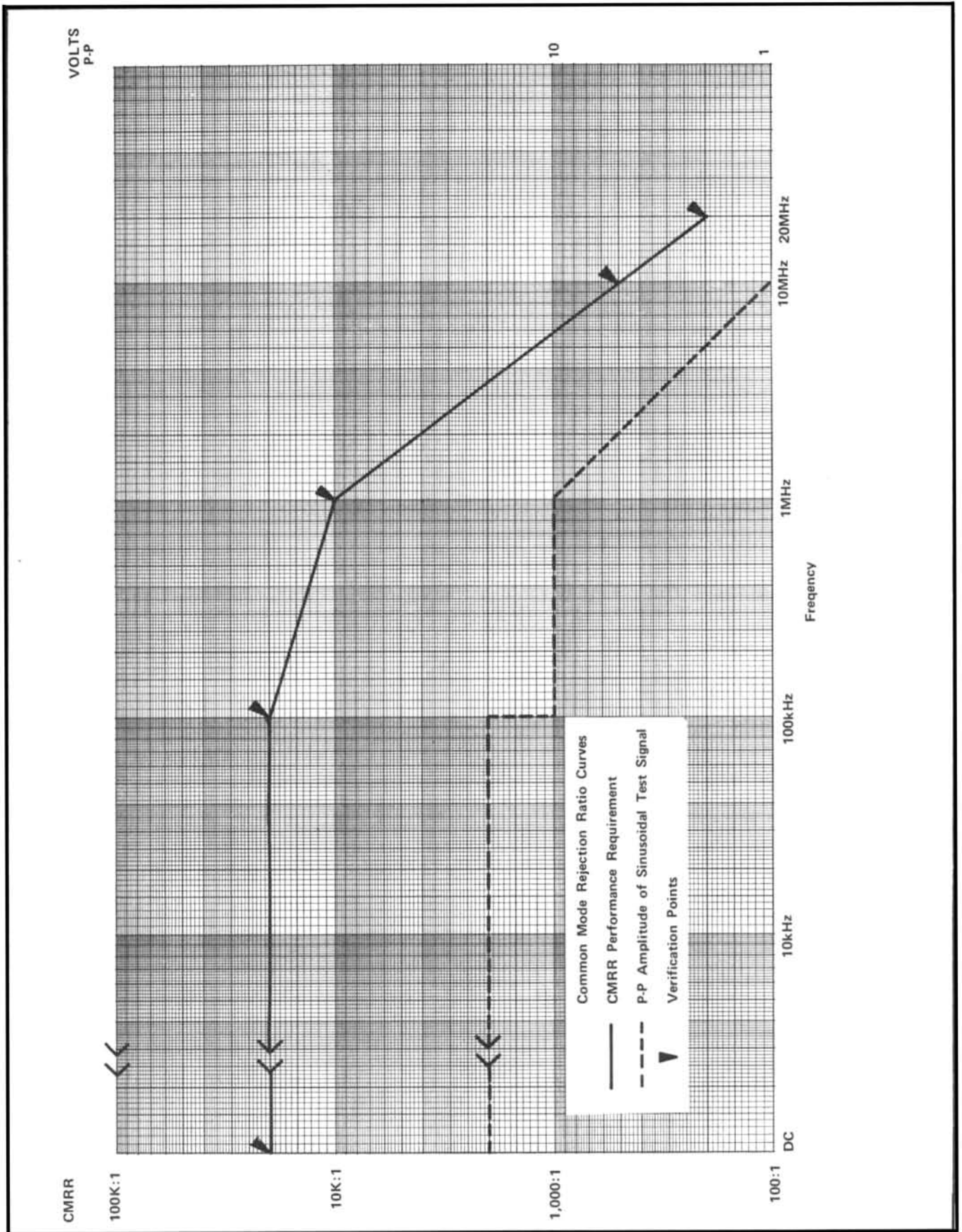

Fig. 1-2. Common mode rejection ratio graph. It pertains to 1 mV/Div through 20 mV/Div deflection factors.

Specification—7A13 (SN B200000-up)

TABLE 1-2

7A13 tested alone (separate from oscilloscope mainframe)

ENVIRONMENTAL CHARACTERISTICS

Characteristic	Performance Requirements
Temperature	Operating: 0°C to +50°C
	Storage: -55°C to +75°C
Altitude	Operating: 15,000 feet
	Storage: 50,000 feet
Transportation	Qualified under National Safe Transit Committee test procedure 1A, Category II.

TABLE 1-3

PHYSICAL CHARACTERISTICS

Size	Fits all 7000-Series plug-in compartments.
Weight	3.1 Pounds (1.4 kilograms).

System Characteristics

The system characteristics listed in Table 1-4 specify the performance of the plug-in with various combinations of probes and in various indicator oscilloscopes.

TABLE 1-4

SYSTEM CHARACTERISTICS

(Indicator Oscilloscope: 7500-Series with P6053B Probe.)

BW (MHz)	T _r (ns)	¹ Accuracy (%)			Sig Out	
		² EXT CAL	³ INT CAL	⁴ INT CAL	BW (MHz)	T _r (ns)
75	4.7	1.5	2.5	3.5	55	6.4
75	4.7	1.5	2.5	3.5	55	6.4

(Indicator Oscilloscope: 7700-Series with P6053B Probe.)

100	3.5	1.5	2.5	3.5	55	6.4
100	3.5	1.5	2.5	3.5	55	6.4

¹Accuracy percentages apply to all deflection factors. Plug-in GAIN must be set at the deflection factor designated at the applicable position of the VOLTS/DIV switch. When a probe is used, the GAIN must be set with the calibration signal applied to the probe tip.

²EXTERNAL CALibrator, 0°C to +50°C: The plug-in GAIN is set (within 10°C of the operating temperature) using an external calibrator signal whose accuracy is within 0.25%.

³INTERNAL CALibrator, +15°C to +35°C: The plug-in GAIN is set using the oscilloscope's own calibrator and the instrument is operating within the +15°C to +35°C range.

⁴INTERNAL CALibrator, 0°C to +50°C: The plug-in GAIN is set (within 10°C of the operating temperature) using the oscilloscope's own calibrator, and the instrument is operating within the 0°C to +50°C range.

OPERATING INSTRUCTIONS

INTRODUCTION

This section opens with a brief functional description of the front panel controls and connectors (see Fig. 2-1). Following the front-panel description is a familiarization procedure and finally a general discussion of the operation of the 7A13.

NOTE

With VOLTS/DIV switch set from .1 V to 5 V, lamp remains on but input impedance is $\approx 1\text{ M}\Omega$ and the input attenuator is uncompensated.

FRONT-PANEL DESCRIPTION

$R_{in} \approx \infty$
1-50 mV
VAR IN ONLY
Lamp

Illuminates when switch S10, located on left side of plug-in, is turned cw. This indicates a + INPUT and - INPUT impedance of approximately infinity whenever the VOLTS/DIV switch is set between 1 and 50 mV, VARIABLE knob is pushed in and 1X probe is used.

COMPARISON
VOLTAGE (V_c)
+ and -
Pushbuttons

Selects polarity of comparison voltage.

VOLTS DISPLAY

Reads out the equivalent voltage selected by the COMPARISON VOLTAGE (V_c) COARSE, FINE, VOLTS/DIV, and PULL VAR for X10 V_c controls.

COARSE Control

Varies the V_c voltage from zero to ten volts.

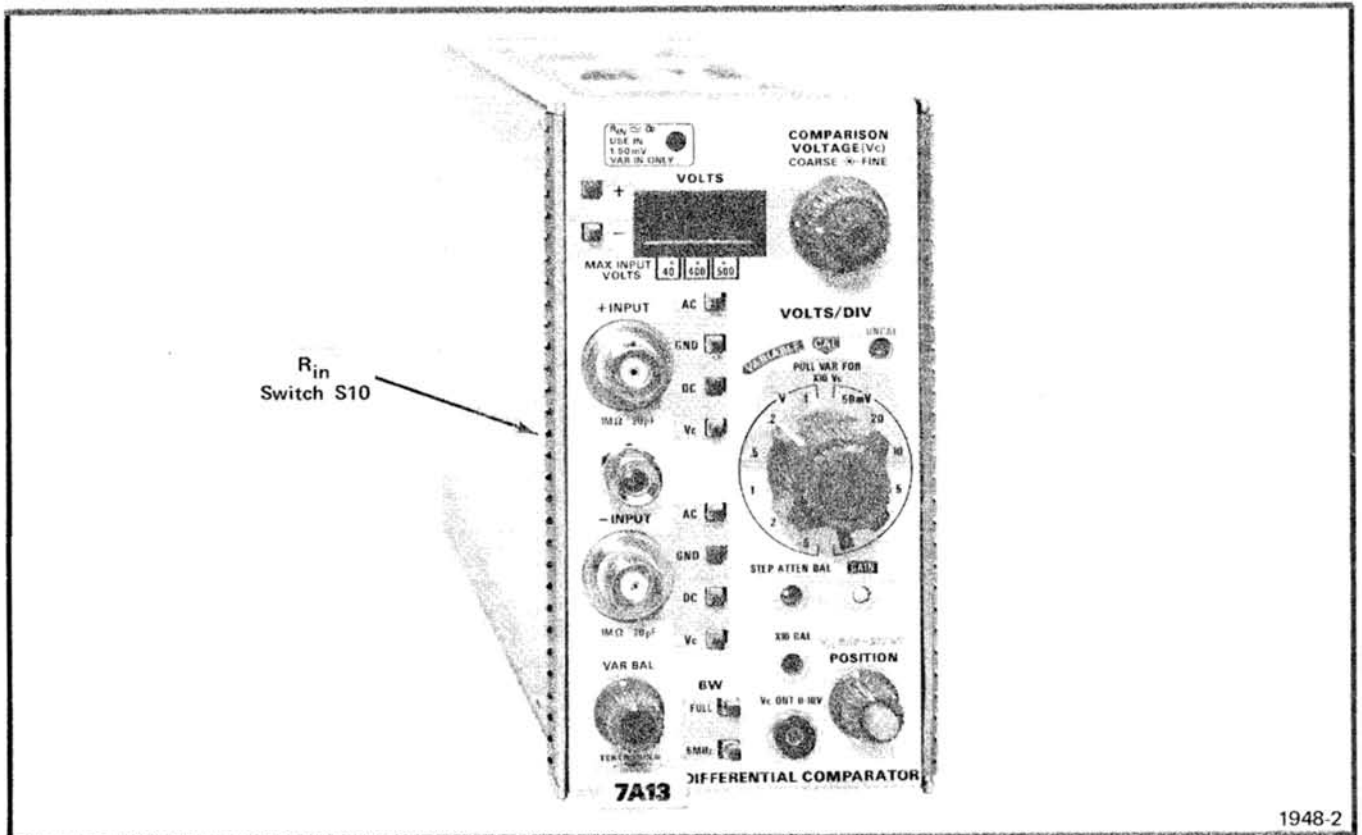

Fig. 2-1. Front panel of 7A13 and location of R_{in} switch S10.

Operating Instructions—7A13 (SN B200000-up)

FINE Control	Provides more precise control of the V_c voltage.	X10 BAL Adjustment	Adjusts for no vertical trace movement as VARIABLE (VOLTS/DIV) knob is pulled out.
+ INPUT Connector	Provides a means of connection for signal measurement. It also contains a third contact for probe attenuation information. This enables proper deflection factor display on the CRT screen, and proper volts display on 7A13.	VAR BAL Control	Adjusts for no vertical trace movement as VARIABLE (VOLTS/DIV) knob is varied throughout its range.
+ INPUT Mode Switch	Selects AC, DC, GND or V_c Mode of coupling for the -- INPUT channel.	Release Latch	Pull to withdraw plug-in from indicator oscilloscope.
VOLTS/DIV Switch	Selects one of twelve volts per division calibrated deflection factors.	BW Switch	Selects either the FULL bandwidth or 5 MHz.
VOLTS/DIV VARIABLE CONTROL	Selects an uncalibrated deflection factor somewhere between the twelve settings. A minimum of 2.5 times the VOLTS/DIV switch setting is provided. The UNCAL lamp lights when the VARIABLE control is out of the CAL detent.	V_c OUT 0-10 V Jack	Provides a convenience outlet for the comparison voltage.
PULL VAR FOR X10 V_c Switch	Extends the deflection factor of the VOLTS/DIV Switch. This occurs only for 10, 20, and 50 mV/DIV and .1, .2, and .5 V/DIV settings of the VOLTS/DIV switch.	POSITION Control	Positions display vertically on the CRT face.
-- INPUT Connector	Same as for + INPUT connector.	V_c REF-IDENT Pushbutton	Internally disconnects both signals and applies V_c to both inputs. Readout display is replaced by the word "IDENTIFY".
INPUT Mode Switch	Selects AC, DC, GND or V_c Mode of coupling for the -- INPUT channel.		
STEP ATTEN BAL Adjustment	Adjusts for no vertical trace movement as the VOLTS/DIV switch setting is varied from 10 to 50 mV/DIV.		
GAIN Adjustment	Adjusts the amplifier gain for display of four divisions upon receipt of a 4 mV signal when the VOLTS/DIV switch is set to 1 mV and the VARIABLE control is set to CAL.		

TEST SETUP CHART

Fig. 2-2 shows a drawing of the front panel controls and connectors. This chart can be reproduced and used as a test setup record for special measurements and applications, or it may be used as a training aid for operation of the 7A13.

FAMILIARIZATION PROCEDURE

First-Time Operation

The following steps are intended to help get the trace on the CRT screen quickly and to prepare the unit for immediate use. These steps are intended to acquaint you with some of the basic functions of the 7A13.

1. Insert the unit into the oscilloscope vertical plug-in compartment.

7A13 DIFFERENTIAL COMPARATOR SETUP CHART

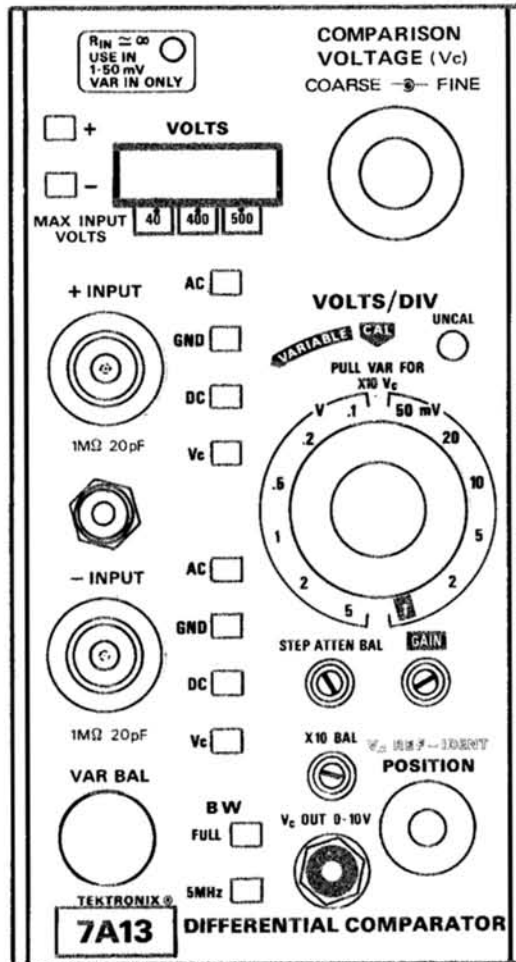

(1113) 1948-3

Fig. 2-2. Test set-up chart.

Operating Instructions—7A13 (SN B200000-up)

2. Set the 7A13 front panel controls as follows:

COMPARISON	VOLTAGE
(V _c) Polarity	Pushbutton canceled
+ INPUT Mode	Gnd
- INPUT Mode	Gnd
VOLTS/DIV	1 V
VARIABLE	In (CAL)
STEP ATTEN BAL	As is
GAIN	As is
X10 BAL	As is
VAR BAL	As is
BW	5 MHz
POSITION	Midrange

3. Turn the Intensity control fully counterclockwise and turn the oscilloscope Power ON. Preset the time-base plug-in controls for a .5 ms/div sweep rate and automatic triggering.

4. Wait about five minutes for the 7A13 and the oscilloscope to warm up.

NOTE

About five minutes is sufficient warmup time when using the 7A13 for short-term DC measurements. For long-term DC measurements using the lower deflection factors, allow at least one hour.

5. Adjust the Intensity control for normal viewing of the trace. The trace should appear near the graticule center.

6. Using the POSITION control, position the trace two divisions below graticule center. Set VOLTS/DIV to 1 mV position.

NOTE

If trace is off screen, perform Front Panel Adjustments outlined below.

7. Vary the VARIABLE control throughout its range while observing the CRT trace.

8. Adjust VAR BAL so that there is no trace movement while varying the VARIABLE control.

9. Vary the VOLTS/DIV switch from 10 mV to 50 mV while observing the CRT trace.

10. Adjust STEP ATTEN BAL so that the trace does not move while varying the VOLTS/DIV switch.

11. Set the VOLTS/DIV switch to 10 mV. Pull out the PULL VAR FOR X10 V_c range knob while observing the CRT trace.

12. Adjust X10 BAL so that there is no trace movement while moving the PULL VAR FOR X10 V_c range knob in and out.

13. Repeat steps 7 through 12 until optimum settings are achieved.

14. Push in the PULL VAR FOR X10 V_c Range knob and set the VOLTS/DIV switch to 1 mV; position the trace two divisions below graticule center.

15. Apply a 4 mV peak-to-peak calibrator signal through a coaxial cable to the + INPUT connector on the 7A13.

16. For DC coupled, single-ended operation, set the + INPUT Mode Switch to DC. The display should be 4 divisions of square wave amplitude.

NOTE

If the display amplitude is not 4 divisions, adjust GAIN control until it is.

17. For AC coupled, single-ended operation, reposition the display to place the bottom of the display at the graticule center line.

18. Set the + INPUT Mode switch to AC and note that the display shifts downward about two divisions to its average level.

19. Disconnect the calibrator signal from the + INPUT connector. Set both the + and - INPUT Mode switches to GND.

Front Panel Adjustments

These adjustments must be accomplished each time the 7A13 is placed in a different oscilloscope and should be checked in the given sequence prior to any critical measurement of waveforms.

Preset 7A13 controls as follows:

COMPARISON	VOLTAGE
+ INPUT Mode	GND
-- INPUT Mode	GND
VOLTS/DIV	1 V
VARIABLE	In (CAL)
STEP ATTEN BAL	Midrange or as is
GAIN	As is
X10 BAL	Midrange or as is
VAR BAL	Midrange or as is
BW	5 MHz
POSITION	Midrange

Allow 20 minutes warmup time.

VAR BAL Adjustment

1. Set the VOLTS/DIV switch to 1 mV.
2. Vary the VARIABLE control throughout its range while observing the CRT trace.
3. Adjust VAR BAL so that there is no trace movement while varying the VARIABLE control.

STEP ATTEN BAL Adjustment

1. Vary the VOLTS/DIV switch from 10 mV to 50 mV while observing the CRT trace.
2. Adjust STEP ATTEN BAL so that the trace does not move while varying the VOLTS/DIV switch.

X10 BAL Adjustment

1. Set the VOLTS/DIV switch to 10 mV. Pull out the PULL VAR FOR X10 V_c Range knob while observing the CRT trace.
2. Adjust X10 BAL so that there is no trace movement while moving the knob in and out.
3. Repeat all balance adjustments until optimum settings are achieved.

GAIN Adjustment

1. Using the POSITION control, position the CRT trace two divisions below graticule center.
2. Set VOLTS/DIV to 1 mV position.
3. Apply a 4 mV peak-to-peak calibrator signal through a coaxial cable to the + INPUT connector on the 7A13.
4. Set the + INPUT Mode switch to DC.
5. Adjust GAIN control so that the display is four divisions of square wave amplitude with the bottom of the display at the reference established in step 1.

GENERAL OPERATING INFORMATION

Signal Connection

In general, probes offer the most convenient means of connecting signals to the inputs of the 7A13. The Tektronix probes are shielded to prevent pickup of electrostatic interference. A 10X attenuator probe offers a high input impedance and allows the circuit under test to perform very close to normal operating conditions. (For further information on the use of probes, see Use of Attenuator Probes in this section of the manual, and in the probe instruction manual).

In high-frequency applications requiring maximum overall bandwidth, use a coaxial cable terminated at both ends in the characteristic impedance of the cable. To maintain the high-frequency characteristics of the applied signal, use high-quality, low-loss cable. Resistive coaxial attenuators can be used to reduce reflections if the applied signal has suitable amplitude.

High-level, low-frequency signals can be connected directly to the 7A13 input with short unshielded leads. This coupling method works best for signals below about one kilohertz and deflection factors above one volt/division. When this method is used, establish a common ground between the 7A13 and the equipment under test (common ground provided by line cords is usually inadequate). Attempt to position the leads away from any source of interference to avoid errors in the display. If interference is excessive with unshielded leads, use a coaxial cable, probe, or differential amplifier operation. (Differential amplifier operation may require special considerations for signal connections. See Differential Operation in this section of the manual).

Operating Instructions—7A13 (SN B200000-up)

Bandwidth Limiter

The BW (bandwidth) switch provides a method of reducing interference from unwanted high-frequency signals when viewing low-frequency signals. With the FULL button pressed, the full bandwidth capabilities of the amplifier are available. When the 5 MHz button is pressed, the upper -3 dB bandwidth point of the amplifier is limited to about 5 MHz. The unwanted high-frequency signals are reduced in the displayed waveform.

Display Identification

When the 7A13 V_C REF-IDENT button is pressed, the signal is internally disconnected. This feature is particularly useful when the 7A13 is used with an indicator unit designed for use with more than one vertical amplifier.

When using an oscilloscope system equipped with the readout feature, the 7A13 deflection factor is displayed on the CRT. When the V_C REF-IDENT button is pressed, the readout information pertaining to the 7A13 is replaced by the word IDENTIFY.

R_{in} Switch

The R_{in} switch S10 (located on left side of the unit) selects the input resistance to ground (+ and $-$ INPUT simultaneously) to be either $1\text{ M}\Omega$ or $\approx \infty$. The R_{in} switch is normally set to the $1\text{ M}\Omega$ position. A front-panel lamp is illuminated to indicate when the R_{in} switch is set to $\approx \infty$.

The high input impedance obtained by setting R_{in} to $\approx \infty$ is useful for measuring voltages in high-impedance circuits where minimum loading is necessary, and the voltage to be measured is within the 10 volt range of the 7A13. Differential comparator operation is used to make the measurement. At null, the comparison voltage is equal to the voltage being measured.

Several precautions must be observed when using the $\approx \infty$ position of the R_{in} switch (1) the VOLTS/DIV control must be set to one of the six positions from 1 to 50 mV; (2) the VARIABLE (VOLTS/DIV) knob must be pushed to the IN position; (3) the INPUT Mode switch of the signal channel must be set to DC.

If the external device does not provide a DC return path for the input FET gate, an external resistance (adequately shielded) must be connected between the input connector and ground.

CALIBRATED DIFFERENTIAL COMPARATOR OPERATION

Introduction

When one of the INPUT switches is set to V_C and the other is set to AC or DC, the 7A13 is operating as a calibrated differential comparator or slide-back voltmeter. The calibrated comparison voltage V_C , can be added differentially to the input signal to obtain a null. For linear operation, Table 1-1 in the Specification section lists the maximum input signal or voltage that can be applied to the 7A13 INPUT connector at a given VOLTS/DIV switch position.

In differential comparator operation the calibrated DC comparison voltage is internally applied, to differentially offset any unwanted portion of the applied signal. This allows measurements of relatively small AC or DC signals riding on top of relatively large AC or DC signals.

The DC comparison voltage is set by the two COMPARISON VOLTAGE (V_C) controls: COARSE and FINE.

Equivalent V_C

When a signal is applied to the 7A13 INPUT connector(s), it is attenuated in the Input Attenuators before being applied to the + or $-$ Input stage. In contrast, the V_C Supply voltage is not attenuated, but is applied (via relays) directly to the Input stage.

Direct application of the V_C to the Input stage makes the $+10\text{ V }V_C$ appear equivalent to the product of the V_C and the attenuation factor of the Input Attenuator. Likewise, the use of an attenuator probe multiplies the V_C by the attenuation factor of the probe.

V_C LED Readout

The front panel, light-emitting-diode VOLTS readout array displays the four-digit V_C value selected by the COMPARISON VOLTAGE (V_C) COARSE and FINE controls. The decimal point placement is switched automatically by internal circuitry for display of the equivalent V_C . Special probes that correct the V_C display (by changing decimal point placement) for the probe attenuation may be used. Attenuator probes not so equipped may be used with the instrument, but the VOLTS display will not be correct. The operator must take this into account when viewing the VOLTS display.

V_C OUT 0-10 V Jack

The V_C OUT 0-10 V jack, mounted on the front panel of the 7A13, permits monitoring of the comparison voltage. The voltage at the jack is set up by the COMPARISON VOLTAGE (V_C) COARSE and FINE controls, and polarity switch. Impedance is 2 k Ω to 5.5 k Ω .

When monitoring the voltage at the jack, the voltage is not affected if an "infinite-impedance type" voltmeter (such as a digital voltmeter or any null type meter which draws negligible current) is used for monitoring purposes.

If the V_C OUT 0-10 V jack is loaded by an external meter, the comparison voltage available at the jack and applied to the input of the amplifier will not be the same as indicated by the VOLTS display.

Differential Operation

Differential measurements are made by applying the signals to the + INPUT and - INPUT connectors. Then, both input Mode switches should be set to the same position: AC or DC, depending on the method of signal coupling desired. When using the 7A13 for differential operation, only the voltage difference between the two signals is amplified and displayed. Common-mode signals (signals that are common in amplitude, frequency, and phase) are rejected and not displayed.

The 7A13 differential input provision may be used to eliminate interfering signals such as AC line-frequency hum. Single-ended measurements often yield unsatisfactory information because of interference resulting from ground-loop currents between the oscilloscope and the device under test.

These limitations of single-ended measurements are virtually eliminated in differential measurements. A differential measurement is made by connecting each of the two inputs to selected points in the test circuit. Since the chassis of the 7A13 need not be connected in any way to the test circuit, there are few limitations to the selection of these test points.

Amplitude and Common-Mode Rejection

In the text which follows, the term "Input Signal Range" means the common-mode operating range of voltage through which the amplifier will produce a usable output. This should not be confused with the maximum (non-destructive) input voltage, which is related to the breakdown limits of the amplifier components.

Factors That Affect CMRR

Frequency. Since the common-mode output voltage is a factor of phase differences as well as gain between channels, the frequency of the input common-mode signal has a direct bearing on the CMRR. Generally, as the frequency of the input signal increases, the CMRR decreases. (Exception: with AC-coupled input, the CMRR will become higher as frequency is increased from DC to over 100 Hz.)

Source Impedance. The specified CMRR assumes that the points being measured have identical source impedance. The source impedance and the amplifier input impedance form an RC divider which determines the portion of the signal that appears across the amplifier input, and the apparent effect on CMRR.

The user may desire to construct a graph of CMRR versus frequency for specific applications where the source or signal transporting lead impedances are unbalanced.

Signal Transporting Leads. A principal requirement for maximum CMRR is that the signals arrive at the amplifier's two inputs with no change in phase or amplitude. Slight differences in attenuation factors, or phase shift between two input attenuators may reduce the CMRR 20% or more.

Attenuator probes extend the usable voltage range of a differential amplifier by reducing the input signal level below the maximum common-mode input voltage. However, a reduction in the apparent CMRR will usually occur because of component value differences within the probes. (See Use of Attenuator Probes in this section).

Ground Connections. Proper grounding reduces signals generated from ground loop currents. It is usually best to electrically connect the probe or signal lead shields together at the probe body or signal source, but not to the instrument ground.

USE OF ATTENUATOR PROBES

General

Attenuator probes reduce the resistive and capacitive loading of the signal source and extend the measurement range to include substantially higher voltages. Passive attenuator probes having different attenuation factors as well as special-purpose types are available from Tektronix, Inc.

Operating Instructions—7A13 (SN B200000-up)

Special probes that correct the oscilloscope deflection factor display, VOLTS display, and MAX INPUT VOLTS indicator to match probe attenuation may be used. (The + and - INPUT connectors have an outer ring that is connected to the Probe Sensing circuit). Attenuator probes not so equipped may be used with the instrument, but they will not operate the sensing circuit. Therefore, the operator must supply the probe attenuation factor for measurements involving the three indicators affected.

NOTE

If two probes with different attenuation are connected to the INPUT connectors (e.g., 10X and 100X), the deflection factor readout, V_c Display, and MAX INPUT VOLTS indicator will be corrected for the probe with the larger division ratio (100X).

Probe Selection

The P6055 probe is recommended for measurements where CMRR up to 20,000:1 must be maintained (100:1 at 20 MHz). The attenuation ratio is adjustable to X10 to compensate for differences in input resistance of the amplifier.

The P6053B probe is recommended for measurements requiring the full bandwidth of the 7A13 (see Table 1-4 in the Specification section). The P6053B also has the sensing capability for deflection factor and V_c Display readout compatibility.

CIRCUIT DESCRIPTION

INTRODUCTION

A block diagram description covering the general configuration of each circuit in the 7A13 is included in this section. Following the block diagram description is a more detailed description, particularly for circuits unique to this instrument.

A block diagram and complete schematic diagrams are included in the Diagrams section at the back of this

manual. These should be referred to throughout the circuit description.

For more information relating to the function or adjustment of variable components, refer to the Performance Check/Calibration procedure in Section 5.

BLOCK DIAGRAM DESCRIPTION

(See Block Diagram Pullout preceding schematics.)

INPUT Mode Switches

A signal applied to either the + or - INPUT connector, as shown by the heavy lines on the Block Diagram, passes through the INPUT Mode switches to the Input Attenuators. The signals can be AC coupled, DC coupled or disconnected internally. (See schematic diagram No. 1.)

Input Attenuators

The Input Attenuators for the + and - inputs are identical and are conventional RC type attenuators. The adjustable resistive elements facilitate matching the - and + attenuators to obtain optimum DC common-mode rejection and precise attenuation ratios.

The attenuators (Schematic Diagram No. 1) are frequency compensated voltage dividers that provide constant attenuation at all frequencies within the bandwidth of the instrument. This is done while maintaining the same input time constant ($20 \mu\text{s}$) for all positions of the VOLTS/DIV switch.

Input Source and Emitter Followers

The Input Source and Emitter Followers are designed to present a very high input impedance at the attenuator's output. Bootstrapping is incorporated in these stages for

each of the + and - inputs. A Current Source is used to supply the proper amount of current for these stages. Each side also contains an overload protection circuit to guard against signals larger than approximately ± 15 volts.

Differential and Common Mode Signal Clamps

The Differential and Common Mode Signal Clamps allow the following Differential Comparator stage to operate linearly for all input conditions. The Differential Mode Signal Clamp limits the output levels to approximately ± 1 volt, whereas the Common Mode Signal Clamp allows a window of at least ± 10 volts.

Differential Comparator

The Differential Comparator operates upon the limited output of the Differential and Common Mode Signal Clamps. The amplified signal is then applied to the gain-switching amplifiers. The gain of the Differential Comparator is approximately one.

1X, 2X, and 5X Gain-Switching Amplifier

The 1X, 2X, and 5X Gain-Switching Amplifier receives the differential signals from the Differential Comparator. Gain switching is accomplished by the VOLTS/DIV switch through relays.

Circuit Description—7A13 (SN B200000-up)

1X and 10X Gain-Switching Amplifier

The 1X, 10X Gain-Switching Amplifier receives the differential signal from the 1X, 2X, and 5X Gain-Switching Amplifier. The gain of this stage is switched through relays by the VOLTS/DIV switch in conjunction with the PULL VAR FOR X10 V_c switch.

Driver Amplifier

The Driver Amplifier receives the differential signals from the 1X, 10X Gain-Switching Amplifier. The gain of the Driver Amplifier is approximately 2.5. Its output signals are applied to the Output Amplifier.

Output Amplifier

The Output Amplifier further amplifies the differential signals and then applies them to the input of the oscilloscope through pins A11 and B11 of the interface connector.

Trigger Amplifier

The Trigger Amplifier receives a portion of the Output Amplifier signal in order to provide + and - internal triggers to drive the Trigger Generator circuit in the time-base plug-in unit.

Feedback Limiter

The Feedback Limiter is driven by signals from the Trigger Amplifier when the output amplitude exceeds a certain limit. These signals are fed back to the 1X, 2X, and 5X Gain-Switching Amplifier stage to limit the incoming signal and prevent the signal from over-driving the succeeding stages into saturation.

Uncal Readout Logic

The Uncal Readout Logic circuit provides the necessary logic to indicate the uncalibrated symbol on the CRT display, and illuminates the UNCAL lamp on the 7A13 when the VARIABLE control is not in the CAL position.

V_c Decimal Point Logic

The V_c Decimal Point Logic provides a logic signal to the DVM circuit, which is determined by the total attenuation of the input signal by the Input Attenuator and divider probe. This provides a decimal point placement signal to the V_c Readout Driver circuit, enabling it to display the equivalent comparison voltage.

V_c Generation and Digital Voltmeter

The comparison voltage (V_c) is derived from a Zener diode reference, and is selectable by the COARSE and FINE front panel controls. The selected value of V_c is measured by the Digital Voltmeter circuit and displayed by the front panel light-emitting-diode array. V_c may also be measured externally at the V_c OUT output jack on the front panel.

Probe Sensing and Trace Identify

The Probe Sensing circuit senses the attenuation factor of an attenuator probe connected to an input. The output of this circuit then adjusts the output of the readout logic and the V_c Decimal Point Logic circuits to include the probe attenuation factor. The inputs to this circuit also provide the trace identify signals to the readout output line and Output Amplifier circuits.

DETAILED CIRCUIT DESCRIPTION

ATTENUATOR AND SWITCHING

The Attenuator and Switching circuitry determines the operating mode and deflection factor of the 7A13. Also included is the circuitry that provides the readout logic to the indicator oscilloscope, and encodes the decimal point placement for the Digital Voltmeter.

INPUT Mode Switches

The separate + and - INPUT switches control the mode of operation for the 7A13. S1 controls the + input side of the amplifier, and S21 controls the - input side. These switches permit connecting one input or the other, or both, to the Input Source and Emitter Follower stages. The V_c position of the INPUT switches applies the comparison voltage, instead of the signal, to one or both sides of the amplifier.

NOTE

The + and - input channels of the 7A13 are similar. To avoid duplication, only the + input channel is described in detail throughout this description.

When the INPUT switch is in the DC position, the input signal is coupled directly to the Input Attenuator. In the AC position, the AC component of the signal is coupled through capacitor C1, while the DC component is blocked. The GND position internally disconnects the signal from the 7A13 and connects ground to the Input Attenuator. This provides a ground reference for the amplifier without requiring removal of the input probes.

When the INPUT switch is set to V_c , relay K10 (relay K30 for - input) disconnects the signal while the comparison voltage V_c is applied to the gate of the input FET. This provides a DC reference for one input of the Differential Comparator while the signal is applied to the other. The front-panel V_c REF-IDENT pushbutton S540, when pressed, actuates both relays K10 and K30 to apply V_c to both input channels simultaneously.

VOLTS/DIV and PULL VAR FOR X10 V_c Switches

The VOLTS/DIV switch, S50, sets the overall deflection factor of the 7A13. The PULL VAR FOR X10 V_c switch, S80, multiplies the equivalent V_c range ten times and increases the maximum input voltage rating of the 7A13. S80 is actuated by pulling the VARIABLE (VOLTS/DIV) knob to

its outer position. A latch on the control shaft prevents the knob from being pulled out unless the VOLTS/DIV switch is in one of its center six positions (10 mV to .5 V).

The functions of these two controls are accomplished by switching relays to switch input attenuators and set the gain of the two gain-switching amplifier stages. The switches also provide signals indicating deflection factor and V_c range to the Readout Logic and V_c Decimal Light Driver stages.

S50 and S80 control the switching relays associated with the following circuits:

1. Input Attenuators. Relays K6-K26 and K7-K27 switch the input signal (both + and - input channels simultaneously) to pass directly to the input FET (1X), pass through one attenuator network (10X), or pass through two attenuator networks (100X). The current to energize the switching relays passes through contacts on both S50 and S80. With S80 pushed in, the Input Attenuators are selected by S50 to be 1X for S50 settings of 1-50 mV; 10X for S50 settings of .1-.5 V; and 100X for S50 settings of 1-5 V. Pulling S80 out increases the input attenuation to 10X for S50 settings of 10 to 50 mV, and 100X for settings of .1 to .5 V.

2. 1X-10X Gain-Switching Amplifier. The gain of this stage is switched by relays K60-K61. The stage gain is maximum when the relays are in the 1X setting. The relays in the 10X position switch in an attenuator to divide the gain by a factor of 10. The relay energizing current passes through contacts on S50 and S80.

3. 1X, 2X, and 5X Gain-Switching Amplifier. Relays K47-K48 switch attenuator networks to reduce the gain of this stage by a factor of 2 or 5. These relays are controlled by S50 only, giving the VOLTS/DIV switch the 1-2-5 sequence.

Thus, S50 selects the amplifier gains and input attenuation as necessary for any specific deflection factor. Pulling out S80 multiplies the equivalent V_c by switching in an attenuator to divide the input signal 10 times; simultaneously, the amplifier gain is multiplied by 10 to retain the deflection factor set by S50.

Circuit Description—7A13 (SN B20000-up)

Input Attenuators

The Input Attenuator circuit consists of two 10X RC divider networks in each input channel. Switching relays K6-K26 and K7-K27 switch the input signals to bypass the RC divider networks for 1X attenuation; pass through one divider network for 10X attenuation; or pass through both networks for 100X attenuation. (The amount of input signal attenuation is determined by the setting of the VOLTS/DIV and PULL VAR FOR X10 Vc switches. For more information, refer to the discussion of these switches and to the schematic diagram.)

In the 1X attenuator setting, the input resistance consists of two resistors in series returned to ground through R_{in} switch S10. The ground return is disconnected when S10 is set to $R_{in} \infty$.

Variable components in the input to the FET adjust to establish the input R and C at 1 M Ω and 20 pF. Variable components in the attenuator networks adjust to provide the following characteristics:

1. The input R and C is normalized at all settings of the VOLTS/DIV switch.
2. Precise attenuation ratios and high-frequency compensation. With these adjustments accurately set, optimum common-mode rejection through the attenuators is achieved.

INPUT AMPLIFIER

Input Source and Emitter Followers

The Input Source and Emitter Followers stage provides a very high input impedance, so as not to load the attenuator circuit elements. This stage includes Q120, source follower; Q130A, emitter follower; and the following: Q140-Q145, constant current source; Q115-Q118, bootstrap emitter followers; Q105, constant current source; and Q110-CR110-CR112-CR101-CR102-CR134, overdrive protection. The overdrive protection circuitry acts to prevent component damage within this stage. The Differential and Common Mode Signal Clamps protect the rest of the amplifier from an input overdrive.

A simplified schematic diagram of this stage is shown in Fig. 3-1. The primary signal path, through Q120 and Q130A, is shown by a heavy line on the diagram. The secondary signal path is from the emitter of Q130A through emitter followers Q118 and Q115. This part of the circuit, called "bootstrapping", allows the drain and collector of Q120 and Q130A to follow the input; maintaining approximately quiescent (or a constant) voltage across Q120 and Q130A. The resistive tails of Q118, Q120, and Q130A all connect to current source Q145 through CR134. The constant current source, in conjunction with the bootstrapping, results in minimal transistor parameter changes, particularly at high frequencies.

The operation of the protection circuitry depends on the polarity of the overdrive signal. Quiescently, Q110 is saturated, forward biasing CR110 to connect +25 V to the input stage. Q105 is operating as a constant current

source for biasing Q115, and CR112 is conducting. Current is returned to the power supply through forward biased CR134 and constant current source Q145. 47 volt zener diode VR103 is in a non-conducting state, with approximately 40 volts DC across it. CR102 and CR101 are reverse biased, and thus non-conducting.

A positive-going over-exursion at the input will forward bias the gate-source junction of Q120 and will saturate Q130A, Q118, and Q115. As the input is rising, the voltages at the cathodes of CR110 and CR112 will reach a level which will reverse bias the diodes. This essentially disconnects the input stage from the + power supplies, allowing the input stage to float with the input. The voltage strain is now across Q145.

If a negative signal is applied to the input, the junction of R124, R126, R134, and CR134 follows. When the voltage at this point is approximately equal to or more negative than the voltage at the collector of Q145, CR134 becomes reverse biased and thus disconnects the input stage from the supply return. If the signal becomes more negative than about -15 volts, CR101 and CR102 become forward biased, thus locking the anode end of VR103 to approximately the same potential as the input. If the input becomes equal to or more negative than about -21 volts, zener diode VR103 begins to conduct, locking the base of Q110 and the base of Q105 to a level about 48 volts above the input. As the input goes more negative, Q110 goes out of saturation and is turned off. This disconnects the input stage from the +25 V supply. The collector of Q105 had been going negative because of the bootstrapping. Now

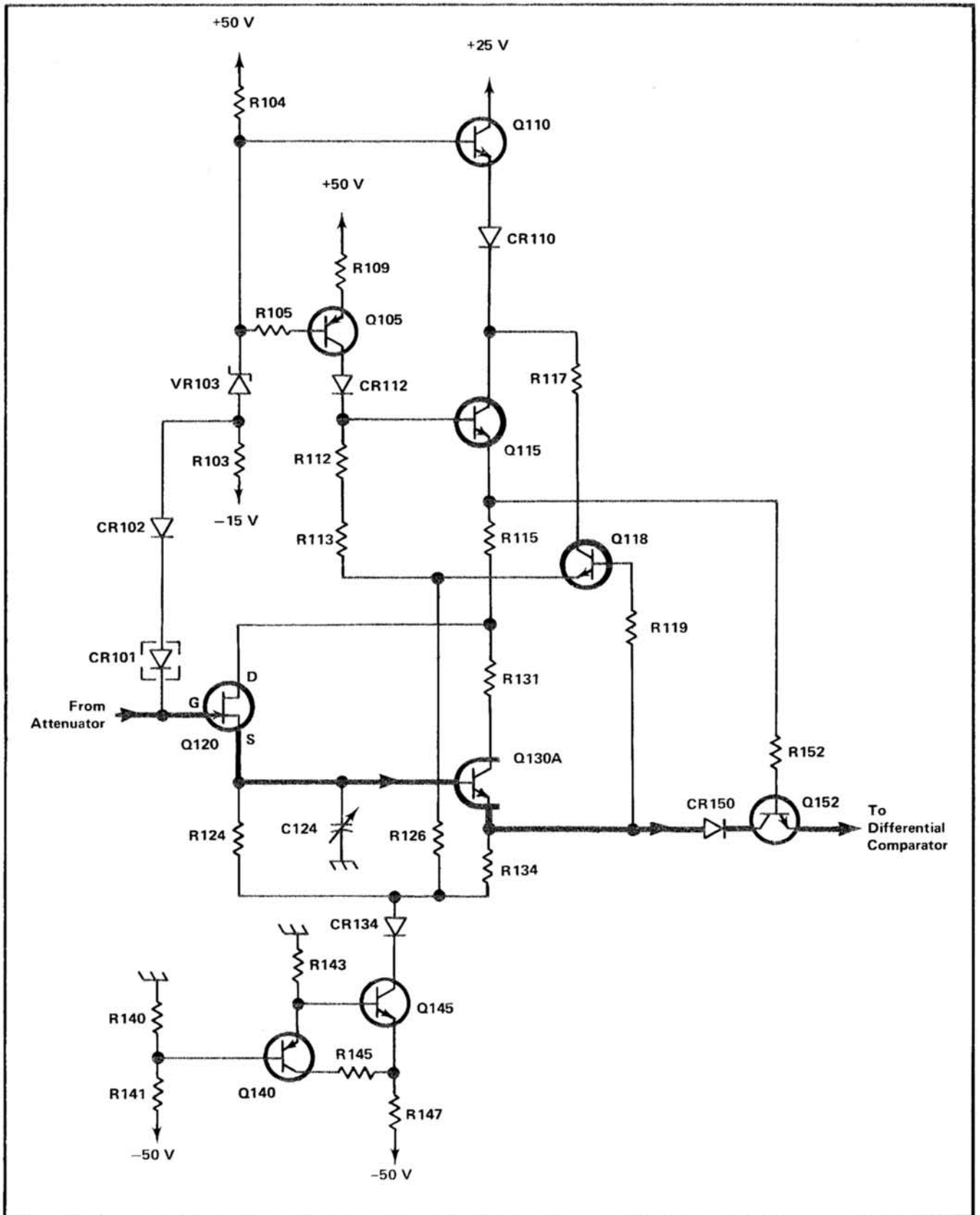

Fig. 3-1. Input Source and Emitter Follower stage, simplified schematic diagram.

Circuit Description—7A13 (SN B200000-up)

that VR103 is conducting, the base and emitter of Q105 are also going negative. This limits the collector-emitter voltage on Q105 so it will not break down, and R109 absorbs the input voltage.

Differential Signal and Common Mode Signal Clamps

The disconnect circuit consists of CR150 and Q152, with the base of Q152 referenced to the other input through the differential clamp diodes CR152, CR252, CR155 and CR159. The Common Mode Signal Clamp circuit includes these and VR155, VR157, CR154, CR156, CR157 and CR158.

Quiescently, CR150 is forward biased and Q152 is saturated. The base of Q152 is fed by a current source so that the base voltage, and hence the emitter voltage, can follow the collector voltage. The differential clamp diodes will conduct whenever the difference between the bases of Q152 and Q252 exceeds about 1.2 volts. When this occurs, the base of Q152 will be clamped. If the signal goes more positive, Q152 will go out of saturation; thus disconnecting the signal from the rest of the amplifier. If the signal goes more negative, CR150 will become reverse biased; again disconnecting the signal from the rest of the amplifier.

The voltages at the junction of VR155 and CR156, and at the junction of VR157 and CR158, are constant at about +12 V and -12 V respectively. When the base voltage of Q152 or Q252 exceeds that voltage sufficiently to forward bias the clamp diodes, the bases will be clamped at that voltage. The operation of Q152 or Q252 is now the same as when the base was clamped by the differential clamp, disconnecting the signal from the rest of the amplifier.

Differential Comparator

The Differential Comparator includes Q160A and B, Q170, Q270, Q255, Q258 and Q165. Q160A and B actually form the comparator, which has a Constant Current Source formed by Q255 and Q258 supplying 25 mA. Bootstrapping is accomplished by Q165. The cascode connections are made to Q170 and Q270.

The gain of the Differential Comparator is approximately one. Diode VR166 is used as a DC level raising diode. R167 is a thermal compensating potentiometer.

The output signal current can be varied by R177, the VARIABLE (VOLTS/DIV) control, to reduce the overall (7A13) gain by a ratio of at least 2.5 to 1. R173 and R175 provide a coarse and fine adjustment for balancing this stage as R177 is varied.

1X, 2X, and 5X Gain-Switching Amplifier

The 1X, 2X, and 5X Gain-Switching Amplifier consists of Q185A and B, Q195A and B, and associated components.

Gain switching is accomplished by means of relays K47 and K48 controlled by the VOLTS/DIV switch, S50 (see Attenuator and Switching schematic). The gain of this stage is maximum when the relays are in the 1X setting. The gain is divided by two in the 2X relay setting by diverting 50% of the (1X) signal current through R193. Similarly, 80% of the (1X) signal current is diverted through R193 in the 5X relay setting.

R288 and R287 provide a coarse and fine adjustment for balancing this stage as the attenuator is switched. R187-C187 adjust the transient response. R196 adjusts the Thermal Balance for transient response.

OUTPUT AMPLIFIER

1X-10X Gain-Switching Amplifier

The 1X-10X Gain-Switching Amplifier stage includes Q300A and B, and Q320A and B.

Gain switching is accomplished by relays K60-K61 in a manner similar to the 1X, 2X, and 5X Gain-Switching Amplifier (see Attenuator and Switching schematic). The gain of this stage is maximum in the 1X relay setting. For 10X attenuation, 90% of the signal current (1X) is diverted through R317.

Thermistor RT303 and varactor diode CR401 provide high-frequency temperature compensation for the amplifier.

R307 and R300 provide internal and front-panel adjustment of DC balance to minimize trace shift due to gain switching.

Driver Amplifier

The Driver Amplifier is a PNP cascode circuit including Q330-Q340, and Q430-Q440. Vertical POSITION, Position Centering, and amplifier GAIN adjustments are accomplished in this stage. Several RC peaking networks are employed in this stage to improve the amplifier transient response. The Driver Amplifier has a voltage gain of approximately 2.7.

Output Amplifier

The Output Amplifier is an NPN cascode amplifier with a voltage gain of approximately 2.7. It includes Q350-Q360, and Q450-Q460.

R360, Sig DC Level, adjusts the DC level at the collectors of Q360 and Q460. R463-C463 across the output of this stage set the net output impedance at 100 ohms at high frequencies. This tends to reverse-terminate the output stage to reduce reflections in the transmission system between the 7A13 and the oscilloscope. CR364 and CR365 limit the output signal swing to ± 0.6 volt.

Bandpass limiting, when selected by the front-panel BW (bandwidth) switch, takes place in this stage. When the BW switch is in the 5 MHz position, C364 and C464 form pi-network filters with L364 and L464. The switching is by means of a switching relay, K490. K480 in the Trigger Amplifier is actuated simultaneously with K480 for bandpass limiting in that stage.

Trigger Amplifier

The Trigger Amplifier consists of Q370, Q470, Q380, Q480, and associated components.

R371 provides an internal adjustment for the Trigger DC Balance, and R380 sets the Trigger DC Level at the collectors of Q380 and Q480. The output of the Trigger Amplifier is applied to the Feedback Limiter circuit, which limits the output signal swing to ± 0.6 volt. C383-R383 reverse-terminate the Trigger Amplifier output by setting the output impedance at 100 ohms at high frequencies.

Capacitors C494 and C492 are switched in by relay K480 when the BW switch is set to 5 MHz. C494 and C492 then form pi-network filters with L384 and L484 to limit the bandpass of the Trigger Amplifier.

Feedback Limiter

The Feedback Limiter includes Q180, Q182, Q280, Q282, and associated components. This circuit prevents all the stages within the feedback loop from being overdriven.

Q180, Q182, Q280, and Q282 are quiescently turned off; acting only on over-excursions in the output of the Trigger Amplifier to reduce the signal drive to Q185A and B.

Q180-Q182 act on positive over-excursions, while Q280-Q282 act on negative over-excursions; the polarity refers to the signal at the collector of Q380, with respect to the collector of Q480. The push-pull output of the Trigger Amplifier is applied to the base-emitter junction of Q180 (Q280). An over-excursion exceeding approximately 0.6 volt will turn on Q180 (Q280). This forward-biases Q182 (Q282) into conduction. Conducting, Q182 in series with R185 (Q282-R285) shunts the differential signal input to Q185A and B.

Uncal Readout Logic

The Uncal Readout Logic circuit consists of Q20 and associated components. This circuit encodes the uncal information of the VARIABLE VOLTS/DIV switch, providing a signal current to the readout logic output lines for an uncalibrated symbol. It also illuminates the UNCAL lamp when the VARIABLE control is not in the CAL position.

Uncalibrated information is generated when -15 V clock pulses from interface connector B32 add current to the column current through R45-CR45 and interface connector A37. When the VARIABLE (VOLTS/DIV) control is in the CAL position, Q20 is saturated to apply $+50$ V through R36 to the junction of CR45-CR46-R45-R36. This positive voltage reverse biases CR45, to block current flow between B32 and A37. When the VARIABLE control is not in the CAL POSITION, $+50$ V from S35 reverse biases CR36 and Q20 through CR35. This removes the reverse bias voltage from CR45 to provide a current path between interface connectors B32 and A37, producing an uncalibrated symbol on the CRT display. Lamp DS47 is illuminated by current flow through R38, when S35 is closed.

V_c Decimal Point Logic Circuit

The V_c Decimal Point Logic circuit consists of Q65, Q70, and Q75 acting as switches between ground and resistors R655, R653, and R651 of the V_c Readout Driver circuit. Current through R655 produces a decimal placement 0.000 (X1) unless changed by the input(s) for a V_c multiplier of X10 or X100 (combined attenuator ratio of probe and Input Attenuator). Multiplier inputs indicating X10 or X100 Input Attenuator settings are currents through resistors R66 and R65 switched through contacts on the VOLTS/DIV and PULL VAR for X10 V_c switches. An input from the Probe Sense circuit corrects for the probe attenuation ratio.

The bias levels on Q65, Q70, and Q75 are established by the resistor-diode network consisting of resistors R63, R64, R71 through R77, and diodes CR66, CR67, and CR77. With no multiplier inputs, bias levels are such that Q65 is

Circuit Description—7A13 (SN B200000-up)

saturated, which provides a current path through R655. With the collector of Q65 near zero volts, a reverse bias is applied to Q70 and Q75, through CR66 and CR67, producing a decimal placement of 0.000.

An input current level indicating a X10 multiplier (either through R66 or from the Probe Sense circuit) reverse biases Q65 to cutoff. With the collector of Q65 near +5 volts, CR66 and CR67 become reverse biased, which forward biases Q70 to saturation, providing a current path through R653. With the collector of Q70 near zero volts, a reverse bias is applied to the base of Q75 through CR76 and CR77. This results in a decimal placement of 00.00.

Similarly, an input current level indicating a X100 multiplier (X100 through R65, X100 through the Probe Sense circuit, or X10 from each input), will result in both Q65 and Q70 being cut off; CR66, CR67, and CR77 reverse biased; and Q75 turned on, providing a current path through R651, resulting in a decimal placement of 000.00.

V_c Generation and Digital Voltmeter Circuit

The comparison voltage (V_c) is derived from a Zener diode reference, and is selectable by the COARSE and FINE front panel controls. The selected value of V_c is measured by the Digital Voltmeter circuit, and may also be measured at the V_c OUT output jack on the front panel.

Zener diode VR683 sets a reference voltage, which is increased to approximately 10.8 volts by amplifier U678C. Resistors R685, R686, and R687 set the output voltage level of the stage. This comparison voltage is applied to the variable voltage divider consisting of COARSE control

R690A and FINE control R690B, along with R692, R693, R726, and R699. +V_c ZERO control R696 sets the V_c minimum voltage level, which is applied to the V_c attenuator circuit and the V_c OUT jack.

Amplifier U678D inverts the comparison voltage and provides the -V_c output to V_c POLARITY switch S570. R741 and C743 filter the V_c output voltage, which is applied through R742 to the attenuator circuit, and through R744 to the front panel V_c OUT jack. -V_c CAL control R727 sets the gain for the inverter amplifier U678D. -V_c ZERO control R720 adjusts for the offset voltage of U678D.

Converter amplifier U678B, with resistor network R681, R678, R679, and R703 produce a reference current (I_{ref}) derived from the output V_c voltage of U678C, for the integrator circuit. The integrator circuit consisting of U678A, R699 and C706 integrates this reference current, along with current derived from the selectable V_c voltage across R699. The result is a generation of positive and negative going current ramps. The ratio of these currents (V_c/R699 to I_{ref}), is proportional to the output voltage (V_c) readings on the LED display. See Fig. 3-2.

The oscillator circuit consisting of Q623, Q629, R623, R626, R628, C627, buffered by Q632, provides a clock input to a 4 1/2 decade (39,999), continuously counting counter U635. U635 contains five binary coded decimal latches and circuitry to scan and update the latches once during each cycle (approximately 8 times per second), providing a multiplexed output.

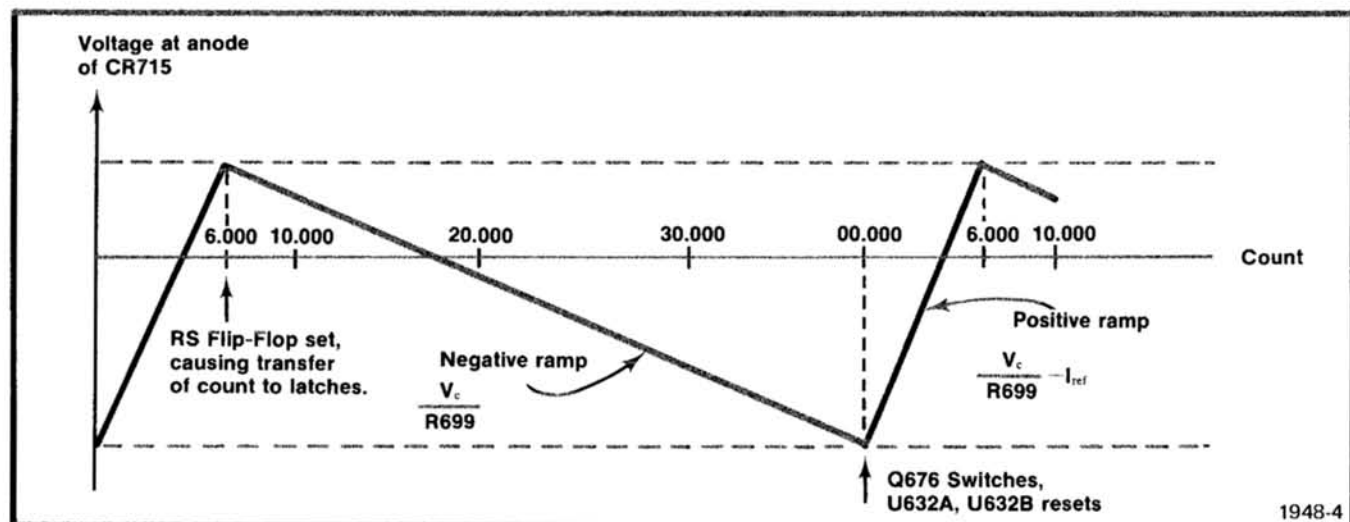

Fig. 3-2. Integrator output voltage for reading of 6000 on LED display.

As the counter overflows to 00,000, pin 16 goes low and resets RS flip-flop U632A, causing pin 5 to go low. This low is coupled to the base of Q676, cutting it off. This causes the reference current from the U678B circuit to be diverted from Q676, allowing it to flow through CR702. The integrating capacitor C706 charges positively, providing a positive going ramp at the anode of CR715. The ramp increases until Q717 conducts, dropping its collector voltage, and toggling the RS flip-flop U632A to its set state. The high voltage at pin 5 turns on Q676, causing it to saturate, which again diverts the reference current from the integrator circuit to Q676 (functioning in an inverted mode), which starts the integration of current $V_c/R699$ for the negative-going ramp.

A high at pin 5 of U632A is also coupled to pin 12 of D flip-flop U632B, causing pin 2 of U635 to go low. This causes an instantaneous count in the counters to be transferred to the decade latches. The ratio of $V_c/R699$ to the reference current (I_{ref}) is such that the count transferred to the latches on each cycle of the counter is equal to the voltage V_c . The maximum value of V_c is nominally 10.05 volts; hence the transferred count will be between 0000 and a maximum of 10050. Since the 5th latch (MSD) of U635 is not used, a count of 10050 would appear on the LED display as 0050.

When the internal counter of U635 cycles from 39,999 to 0000, it pauses for 10 counts before continuing, allowing switching transients to die out. This has the effect of subtracting 10 counts (equal to 10 mV at the V_c output) from the transferred count. To compensate for this, a -10 mV offset is added to the input of the integrator amplifier U678A, by the DVM Zero control R708.

V_c Readout Driver Circuit.

Refer to Diagram 5. U665 is a 4 digit common-cathode light-emitting-diode (LED) display. It is driven by the BCD to seven-segment decoder driver U668, the digit drivers Q637, Q640, Q644, Q648, and a Decimal Point Driver Q658. As a digit is selected by the scanner circuit within U635, the corresponding digit select output at pin 0_A , 0_B , 0_C , 0_D goes high, turning on the appropriate digit driver. At the same time, the BCD output for that digit, at 0_1 , 0_2 , 0_4 , and 0_8 of U635, will be decoded and buffered by U668, providing a 7 segment driving signal to U665.

Fig. 3-3 shows the time relationship of the U635 Decade Counter data output pulses, and illustrates the signals producing a readout of 1296 on the LED display. Pulses to the Step input of U635 drive the internal scanner circuit (at 1/100 of the clock frequency), causing high levels to be produced sequentially at digit selected outputs 0_A , 0_B , 0_C , 0_D , and simultaneously producing the corresponding BCD signals at 0_1 , 0_2 , 0_4 , and 0_8 . For example, while the least significant digit select output 0_A is high, outputs 0_1

and 0_8 are low, and 0_2 and 0_4 high, producing a binary coded decimal (BCD) output equivalent to number 6. This binary (0110) signal is encoded by U668 into a seven-segment driving signal for U665. To produce a 6 in the least significant position of the LED display, two conditions are met. The input signals to U665 are high at A, C, D, E, F, and G, and low at B; second, the high level at 0_A turns on Q637 providing a low at pin 7 of U665. This provides a current path to ground for the light-emitting-diodes, which forms the number 6 on the LED display. Other digits are displayed in a similar manner.

Transistors Q640, Q644, and Q648 perform two functions. First, they provide a current path to ground for the light-emitting-diodes of digit 1, 2, and 9, when turned on by the respective digit select outputs 0_B , 0_C , or 0_D ; also,

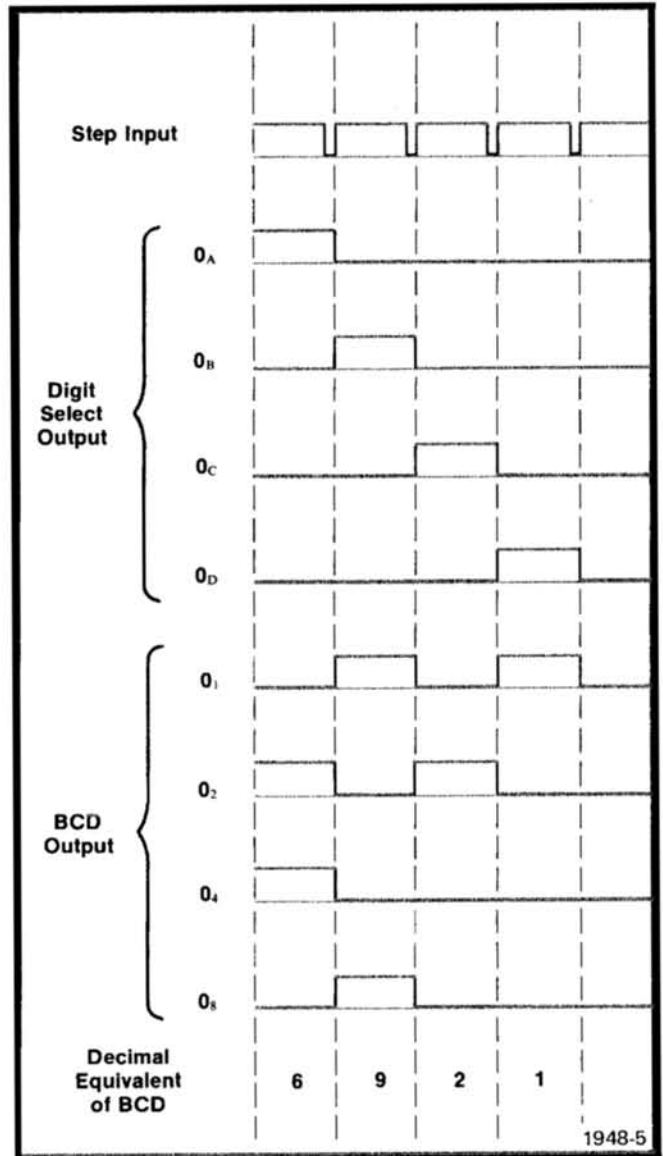

Fig. 3-3. Time relationship of the pulses from U635.

Circuit Description—7A13 (SN B200000-up)

they form part of a circuit to time-multiplex drive signals to Q658, producing the required decimal point placement on the LED display. For example, if the decimal placement is 129.6, the voltage produced by the Decimal Point Logic circuit will be approximately zero volt at pin AA, and approximately five volts at pins AB and AC, at P650, reverse biasing CR645 and CR649. Quiescently, Q640 is cut off, causing current flow through divider R641, CR641, and R651, producing approximately 4.0 volts at the cathode of CR641. Q658 is biased at threshold by the divider R657, CR651, and CR641 cathode voltage. When the digit select output pulse 0_B arrives, Q640 turns on, its output goes low, and CR641 is cut off. This causes CR651 to conduct hard, saturating Q658, which allows current to flow through R661, to pin 5 of U665, and through the decimal point light-emitting-diode for the least significant digit, producing a decimal placement 129.6. The collector voltage at Q658 is also coupled to pin 12 of U635, providing leading zero suppression. Thus, the readout 000.0 will actually appear as 0.0 on the LED display. Other decimal points are produced in a similar manner by Q644 and Q648.

Large current fluctuations produced by the LED display circuit are reduced by the shunt regulator, composed of Q604, Q607, and Q611. This is achieved by the negative feedback action of Q607, with the base acting as the input, and Q611 as the output stage. R609 prevents large voltage variations from appearing in the 5-volt source supply.

Probe Sense

The Probe Sense circuit consists of Q40 and Q60 and associated components. This circuit identifies the attenuation factor of the probe connected to the front-panel connector by sensing the amount of current flowing from the current sink (R40-R42) through the probe coding resistance. The outputs of this circuit adjust the readout logic and the V_c Decimal Point logic circuits so their outputs include the probe attenuation factor.

The third contact of the + (or -) INPUT connector provides the input to the Probe Sense circuit from the probe coding resistance (coded probes only; see Operating Instructions). The third contact is also used for the IDENTIFY input. The coding resistor forms a voltage divider with R40 (R42 through CR42) to the -15 V supply. The resultant voltage sets the bias on Q40 and Q60, and determines (along with their respective emitter resistors) their collector currents.

The collector current of Q60 adjusts the bias levels in the V_c Decimal Point logic circuit. The output of Q40 affects the readout logic output in the following manner. When the -15 V clock pulse is applied to interface connector B33, Q40 is interrogated and its collector current is added to the column current through interface connector A37.

With a 1X probe (or no probe) connected, Q40 and Q60 are turned off, and thus have no output.

When different-attenuation divider probes are connected to the + and - INPUT connectors, the outputs of the Probe Sense circuit will indicate the attenuation factor of the probe having the larger divider.

V_c REFERENCE and Trace IDENTIFY

The V_c REF-IDENT pushbutton, when pressed, does two things:

1. V_c is connected to the gates of the input FET's via relays K10-K30, while the input signal (if any) is disconnected.

2. Connects ground to the bases of Q40 and Q60 through CR43 and CR44. This low value of bias will: (1) cause Q40 to turn on hard when interrogated, replacing the deflection factor readout display with the word "IDENTIFY"; (2) move the V_c Counter decimal to the far right.

When the probe Identify pushbutton is pressed, the effect on the Readout Logic and V_c Decimal Point logic circuits is the same as when the V_c REF-IDENT front-panel pushbutton is pressed. However, the trace is not returned to center screen, but is shifted upward slightly. This is accomplished by inserting a resistor, R376, from ground through CR46 or CR47 to the base of Q470 (Trigger Amplifier, diagram 3). This shunts a small amount of the output current, causing the trace to move.

These two actions aid in identifying the 7A13 trace when multiple traces are displayed.

DISTRIBUTION DIAGRAM

Low Voltage Power Supplies

The Low Voltage Power Supplies operate upon receipt of +50 V DC, +15 V DC, -15 V DC and -50 V DC to produce the following voltages: +50 V DC, +25 V DC, +14 V DC, +8 V DC, +5 V DC, -8 V DC, -15 V DC and -50 V DC. These voltages are further divided into several decoupled supplies. For example, +15 V DC is decoupled five times, once for each load. Similarly the other DC supplies are decoupled from their loads.

MAINTENANCE

Introduction

This section of the manual contains maintenance information for use in preventive maintenance, corrective maintenance and troubleshooting of the 7A13.

PREVENTIVE MAINTENANCE

General

Preventive maintenance consists of cleaning, visual inspection, lubrication, etc. Preventive maintenance performed on a regular basis may prevent instrument breakdown and will improve reliability of this instrument. The severity of the environment to which the 7A13 is subjected determines the frequency of maintenance. A convenient time to perform preventive maintenance is preceding recalibration of the instrument.

Cleaning

The 7A13 should be cleaned as often as operating conditions require. Accumulation of dirt in the instrument can cause overheating and component breakdown. Dirt on the components acts as an insulating blanket and prevents effective heat dissipation. It may also provide an electrical conduction path.

CAUTION

Avoid the use of chemical cleaning agents which might damage the plastics used in this instrument. Special care should be taken when cleaning the Polyphenylene Oxide attenuator boards. Do not apply any solvent containing ketones, esters or halogenated hydrocarbons. To clean, use only water soluble detergents, ethyl, methyl or isopropyl alcohol.

The covers of the oscilloscope minimize the amount of dust which reaches the interior of the 7A13. Operation of the system without the oscilloscope covers in place necessitates more frequent cleaning. When the 7A13 is not in use, it should be stored in a protected location such as a dust-tight cabinet.

Exterior. Loose dust accumulated on the outside of the 7A13 can be removed with a soft cloth or small paint brush. The paint brush is particularly useful for dislodging dirt on and around the front-panel controls. Dirt which remains can be removed with a soft cloth dampened in a mild detergent and water solution. Abrasive cleaners should not be used.

Interior. Dust in the interior of the instrument should be removed occasionally due to its electrical conductivity under high-humidity conditions. The best way to clean the interior is to blow off the accumulated dust with dry, low-velocity air. Remove any dirt which remains with a soft paint brush or a cloth dampened with a mild detergent and water solution. A cotton-tipped applicator is useful for cleaning in narrow spaces.

Visual Inspection

The 7A13 should be inspected occasionally for such defects as broken connections, broken or damaged circuit boards, improperly seated transistors or relays and heat-damaged parts.

The corrective procedure for most visible defects is obvious. However, particular care must be taken if heat-damaged components are found. Over-heating usually indicates other trouble in the instrument; therefore, it is important that the cause of overheating be corrected to prevent a recurrence of the damage.

Semiconductor Checks

Periodic checks of the semiconductors in the 7A13 are not recommended. The best check of semiconductor performance is actual operation in the instrument. More details on checking semiconductor operation are given under Troubleshooting.

Maintenance—7A13 (SN B200000-up)

Recalibration

To ensure accurate measurements, check the calibration of this instrument after each 1000 hours of operation of every six months if used infrequently. In addition, replacement of components may necessitate recalibration of the affected circuits. Complete calibration instructions are given in Section 5.

The Performance Check/Calibration procedure can also be helpful in localizing certain troubles in the instrument. In some cases, minor troubles may be revealed and/or corrected by calibration.

TROUBLESHOOTING

Introduction

The following information is provided to facilitate troubleshooting of the 7A13. Information contained in other sections should be used along with the following information to aid in locating the defective component. An understanding of the circuit operation is very helpful in locating troubles. See the Circuit Description section for complete information.

General

If trouble occurs in the 7A13, the following procedure is recommended to accomplish rapid and effective repairs.

1. Check that the plug-in unit and the oscilloscope connectors are not damaged, and that the plug-in unit is properly inserted.
2. Inspect the front panel of the 7A13 and indicator oscilloscope to be sure that the trouble is not from an incorrect control setting.
3. Insure that the indicator oscilloscope is not at fault by inserting a known properly-operating plug-in unit and checking its operation.
4. Determine all trouble symptoms.
5. Perform a visual inspection of the 7A13.
6. Repair or replace obviously defective parts.
7. Troubleshoot the 7A13 as necessary.
8. Recalibrate the 7A13.

Troubleshooting Aids

Diagrams. Circuit diagrams are given on foldout pages in the Diagrams Section. The component number and electrical value of each component are shown on the diagrams as well as important voltages and waveforms.

Resistor Color-Code. In addition to the brown composition resistors, some wire-wound resistors and some metal-film resistors are used in this instrument. The resistance values of wire-wound resistors are printed on the body of the component. The resistance values of composition resistors and metal-film resistors are color-coded on the components (some metal-film resistors may have the value printed on the body) with EIA color-code. The color code is read starting with a stripe nearest the end of the resistor. Composition resistors have four stripes which consist of two significant figures, a multiplier and a tolerance value (see Fig. 4-1). Metal-film resistors have five stripes consisting of three significant figures, a multiplier and a tolerance value.

Capacitor Marking. The capacitance values of common disc capacitors and small electrolytics are marked in microfarads on the side of the component body. The white ceramic capacitors used in the 7A13 are color-coded in pico-farads using a modified EIA code (see Fig. 4-1).

Diode Color Code. The cathode end of each glass-encased diode is indicated by a stripe, a series of stripes or a dot. For most silicon or germanium diodes with a series of stripes, the color code also indicates the type of diode or identifies the Tektronix Part Number using the resistor color-code system (e.g., a diode color-coded blue or pink-brown-gray-green indicates Tektronix Part Number 152-0185-00). The cathode and anode ends of metal-encased diodes can be identified by the diode symbol marked on the body.

Semiconductor Lead Configuration. Fig. 4-2 shows the lead configuration of the semiconductors used in this instrument. The view is as seen from the bottom of the semiconductor.

Multi-Connector Holders. The multi-connector holder is keyed with two triangles, one on the holder and one on the circuit board. When the holder is mounted parallel to a circuit board, the triangle and the slot numbers on the connector holder should face away from the board surface. When a connection is made perpendicular to a circuit board surface, the orientation of the triangle and the slot numbers on the connector holder is determined by the direction of the nomenclature marking.

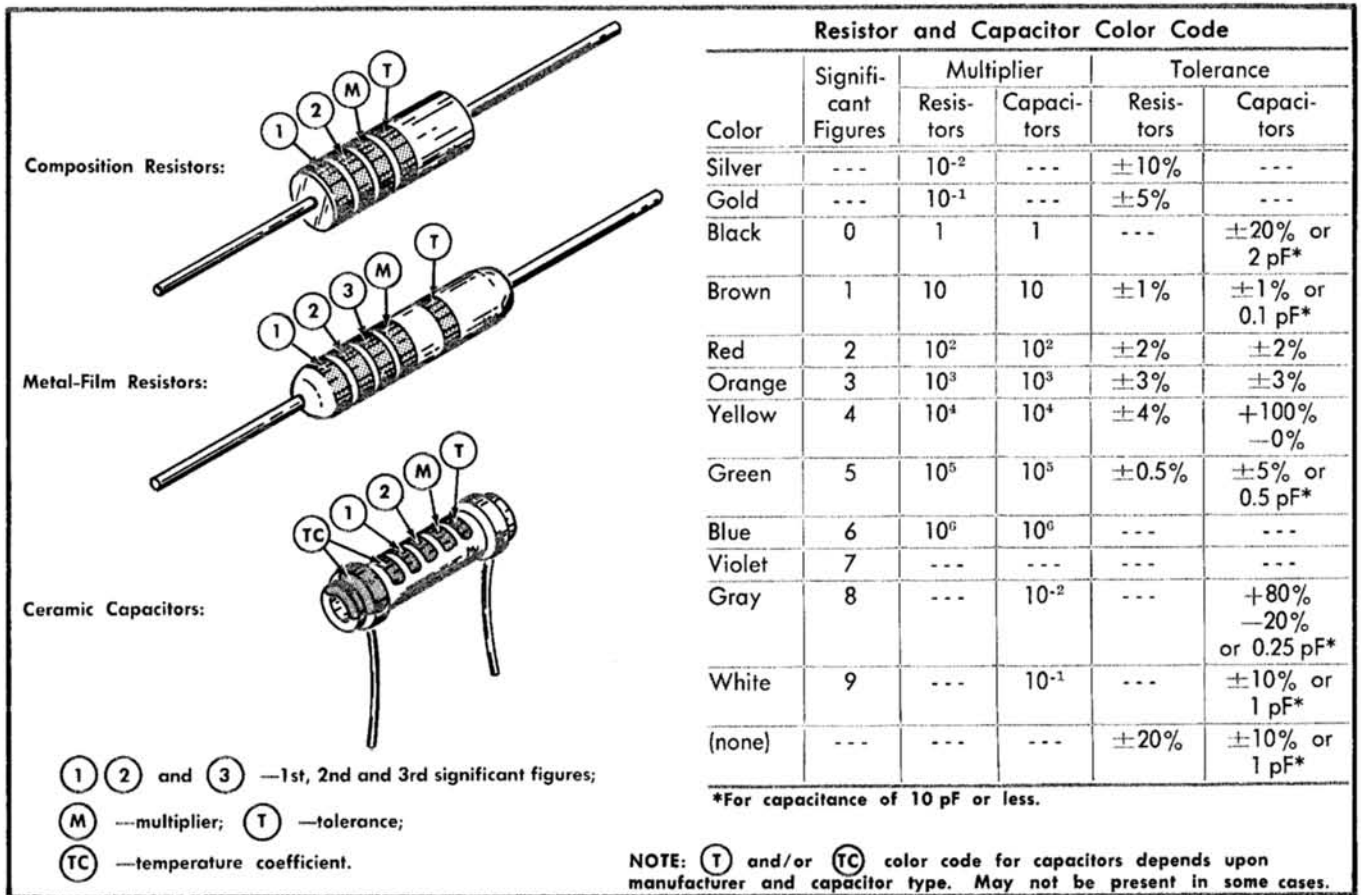

Fig. 4-1. Resistor and capacitor color code.

Circuit Board Illustrations. Illustrations of the individual circuit boards showing component locations and/or wiring color code are located opposite the diagram pullout pages.

Switch Wafer Identification. Wafers for the switches are coded on the schematic diagrams to indicate the physical location of the wafer on the actual switches. The number portion of the code refers to the wafer number on the switch assembly. Wafers are numbered from the first wafer located behind the detent section of the switch to the last wafer. The letters F and R indicate whether the front or rear of the wafer is used to perform the particular switching function. For example, 3F of the VOLTS/DIV switch indicates that this is the front side of the third wafer when counting back from the front panel.

Wiring Color Code. All insulated wires in the 7A13 are color coded to facilitate tracing the wire from one point to another.

Test Equipment Recommended for Troubleshooting

The test equipment listed here should suffice for most troubleshooting jobs. Test equipment required for calibration is listed in the Performance Check/Calibration section of this manual.

High Impedance Voltmeter (20,000 Ω /DC or greater)

Ohmmeter (2 mA or less current on the X1 k Ω scale)

Test Oscilloscope and Probes

Plug-In Extender

Dynamic Transistor Tester

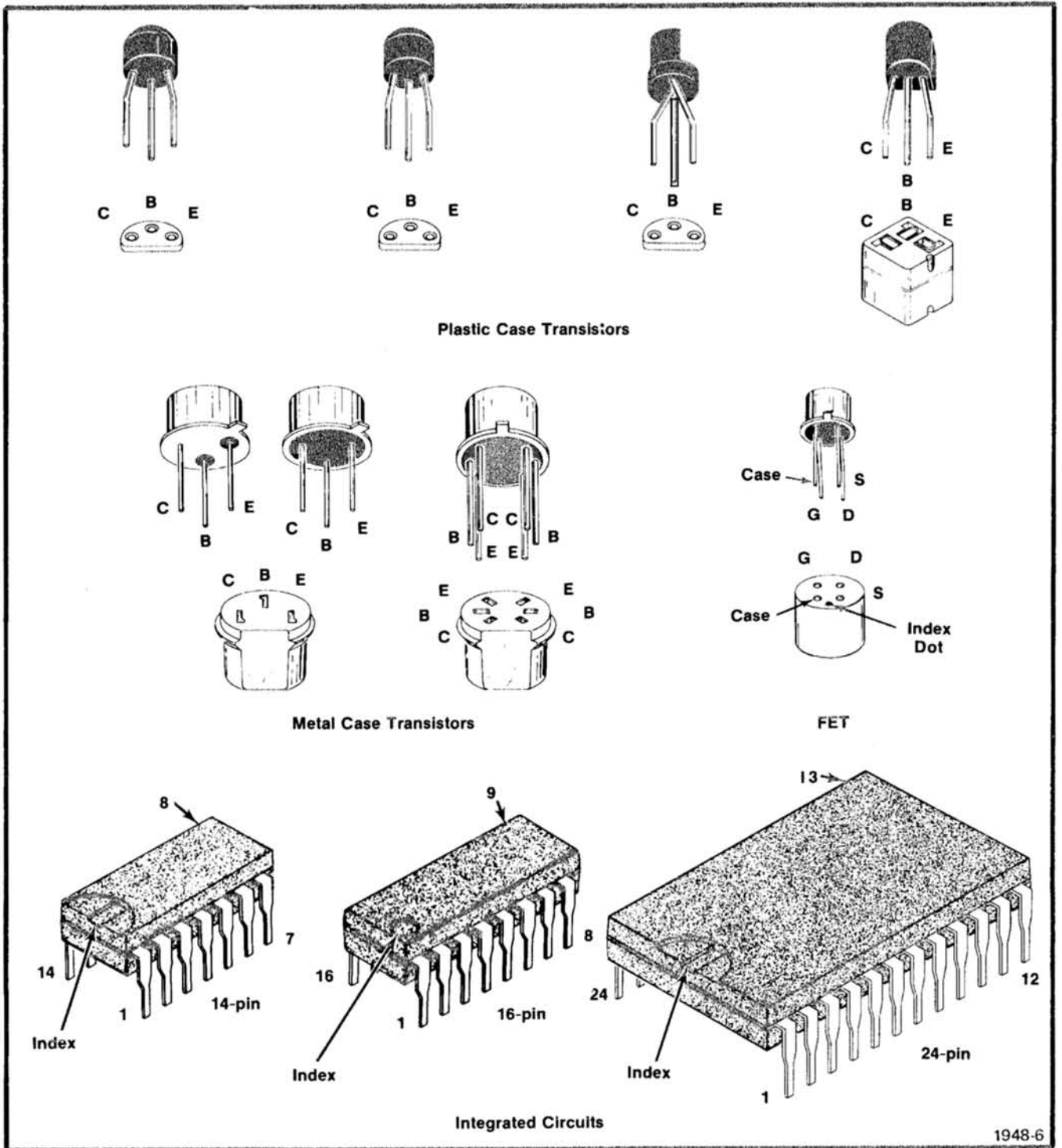

Fig. 4-2. Semiconductor lead configuration.

If the output DC balance is checked first and is in error, work toward the front until an unbalance no longer exists. This localizes the trouble to the circuitry between the points which are balanced and the points which are unbalanced. The individual components must then be checked.

Troubleshooting Techniques

This troubleshooting procedure is arranged in an order which checks the simple trouble possibilities before proceeding with more detailed troubleshooting. The first few checks assure proper connection, operation and

calibration. If the trouble is not located by these checks, the remaining steps aid in isolating the trouble to a particular circuit; then the circuit must be checked to locate the defect in the circuit. When the defect is located, the repair should be made using the information provided in the Corrective Maintenance portion of this section.

1. Check Front-Panel Control Settings. Control settings can indicate a trouble that does not exist. For example, an incorrect setting of the VARIABLE control appears as incorrect function or operation of any control, see the Operating Instructions section for the 7A13 or the associated oscilloscope.

2. Isolate Trouble to 7A13 or Oscilloscope. When following a troubleshooting procedure, it is assumed that the oscilloscope used with the 7A13 is operating normally. Since this is not always the case, check the operation of the oscilloscope before attempting to troubleshoot the 7A13.

3. Check Instrument Calibration. Check the calibration of this instrument, or the affected circuit if the trouble exists in one circuit. The apparent trouble may only be a result of misadjustment or may be corrected by calibration. Complete instructions are given in the Calibration Section.

4. Visual Check. Visually check the portion of the instrument in which the trouble is located. Many troubles can be located by visual indications such as broken wires, unsoldered connections, damaged components, etc.

5. Isolate Trouble to a Circuit. To isolate a trouble to a circuit, note the trouble symptoms. The symptom often indicates the circuit in which a trouble is located. When trouble symptoms appear in more than one circuit, check all affected circuits by taking voltage and waveform readings. If the signal is correct, the circuit is working correctly up to that point.

NOTE

To locate intermittent or temperature sensitive components mounted on the attenuator boards, Quik-Freeze (Miller Stephenson, MS-240, Tektronix Part Number 006-0173-01) is recommended. Dry ice or dichlorodifluoromethane (Freon 12, Dupont or Can-O-Gas) may also be used. Zero Mist Circuit Cooler (GC Electronics) will damage the polyphenylene oxide boards.

6. Check Voltages and Waveforms. Often the defective component can be located by checking for the correct

voltage or waveform in the circuit. Typical voltages and waveforms are given on the diagrams.

NOTE

Voltages and waveforms given on the diagrams are not absolute and may vary slightly between instruments. To obtain operating conditions similar to those used to take these readings, see page 7-2.

Isolating DC Imbalance. A properly operating oscilloscope will have its trace centered vertically on the CRT only when the 7A13 has a balanced output. The 7A13 is a balanced amplifier when the POSITION control is set to midrange and all the DC balance controls are properly adjusted. With no signal or comparison voltage applied to the FET gates (Q120, Q220), any point in the +Input side of the circuit should have a potential essentially equal (except for a minor voltage difference occurring in the Input Amplifier stages) to that at an identical point in the -Input side of the circuit.

If the CRT trace is deflected off the screen as a result of a 7A13 problem, DC unbalances exist. They can be detected by connecting a DC voltmeter between identical points such as those listed in Table 4-1. (A plug-in extender is needed during this procedure to allow access to the points being checked.) Voltage difference limits are provided in the table to show how much voltage difference can be present between two points when the trace is positioned to the top or bottom of the graticule with respect to graticule center. If these limits are not exceeded, the trace should be present within the graticule viewing area.

Table 4-1

**DC IMBALANCE VOLTAGE DIFFERENCE LIMITS
(VOLTS/DIV SWITCH SET TO .1)**

DC Voltmeter Connected Between the Following Test Points	Voltage Difference Limits ¹
TP360 and TP460	±0.20 V DC
Q340 Collector and Q440 Collector	±0.07 V DC
Q330 Base and Q430 Base	±0.02 V DC
Q300A Collector and Q300B Collector	±0.10 V DC
Q195A Collector and Q195B Collector	±0.02 V DC
Q170 Collector and Q270 Collector	±0.03 V DC
Q152 Emitter and Q252 Emitter	±0.03 V DC ²
Q130A Emitter and Q130B Emitter	±0.04 V DC ²

¹To obtain on-screen positioning of the trace.

²Take into consideration that an additional voltage difference as high as ±0.04 V can be present between these two points in a normal operating plug-in unit.

Maintenance—7A13 (SN B200000-up)

As a suggested procedure, check the output DC balance first. If it is in error, work toward the input stages until an unbalance no longer is detected. This localizes the trouble to the circuitry between the points providing balance and those providing unbalance.

Signal Tracing. A method is described here for checking waveform amplitude and polarity at the test point shown on the Attenuator & Switching Input Amplifier and Output Amplifier schematic diagrams. The technique is based on using a plug-in extender to operate the 7A13 outside the oscilloscope plug-in compartment. The plug-in extender permits access to the circuits in the 7A13 for detailed signal tracing and troubleshooting.

After the faulty stage is located and the trouble found and corrected, then it is easy to remove the extender, insert the plug-in in the oscilloscope and go directly to the Performance Check/Calibration procedure in Section 5 to check frequency compensation and other performance requirements.

To signal trace the 7A13 amplifier stages, proceed as follows:

1. Connect a plug-in extender between the 7A13 and the indicator oscilloscope.

2. Set the front-panel controls of the 7A13 to the same positions as listed in the Voltage and Waveform Conditions.

3. Apply a 4 V peak to peak calibrator signal through a T connector and coaxial cables to the 7A13 Input connector and to the test oscilloscope external Trigger Input connector.

4. Set the test oscilloscope Input Coupling switch to AC, the V/Div switch to .1, the Time/div switch to 0.2 ms, and the triggering controls for +EXT triggering on the 4 V calibrator signal.

5. Remove the attenuator shield. Touch the test oscilloscope 10X probe tip to the soldered connection (wired end) of the Input connector center conductor for the channel to be checked.

6. Set the test oscilloscope Triggering Level control so the first half cycle of the waveform is positive going. The displayed waveform on the test oscilloscope should correspond to the waveform polarity and amplitude shown in waveform 1 on the Attenuator & Switching diagram. Disconnect the probe.

7. On the diagram, locate the next test point where a waveform is shown. Set the test oscilloscope vertical deflection factor to correspond to the setting given on the waveform.

8. Locate the same test point in the 7A13 that corresponds to the one on the diagram and connect the probe tip to this test point. Check the displayed waveform amplitude and polarity. Disconnect the probe.

9. Repeat steps 7 and 8 until a test point is found where an abnormal indication is definitely obtained. Then proceed with detailed troubleshooting checks between that stage and preceding test point to isolate the trouble to the smallest possible area until the cause of the trouble is found. Detailed checks consist of signal tracing the circuits between the test points to determine where the signal becomes abnormal. Then voltage checks may have to be made; semiconductors and other components may have to be substituted.

7. Check Individual Components. The following procedures describe methods of checking individual components in the 7A13. Components which are soldered in place are best checked by disconnecting one end. This isolates the measurement from the effects of surrounding circuitry.

Transistors (including FET's). The best means of checking a transistor is by using a transistor curve display instrument such as a Tektronix Type 576. If a transistor checker is not readily available, a defective transistor can be located by signal tracing, by making in-circuit voltage checks, by measuring the transistor resistances or by the substitution method previously described.

When troubleshooting using a voltmeter, measure the emitter-to-base and emitter-to-collector voltages to determine whether the voltages are consistent with normal circuit voltages. Voltages across a transistor vary with the device and its circuit function. Some of these voltages are predictable. A silicon transistor will normally be 0.6 V. The collector-emitter voltage will vary with the circuit and circuit conditions, but it should always exceed 0.5 V. The best way of checking these devices is by connecting a voltmeter across the junction and using a sensitive voltmeter setting.

An ohmmeter can be used to check a transistor if the ohmmeter's voltage source and current are kept within safe limits. 1.5 V and 2 mA are generally acceptable. Selecting the X1 k Ω scale on most ohmmeters will provide voltage and current below these values.

Table 4-2 contains the normal values of resistance to expect when making an ohmmeter check of an otherwise unconnected transistor.

Table 4-2
TRANSISTOR RESISTANCE CHECKS³

Ohmmeter Connections	Resistance Reading That Can Be Expected Using the R X 1 k Range
Emitter-Collector	High readings both ways
Emitter-Base	High reading one way, low reading the other way
Base-Collector	High reading one way, low reading the other way

³Test prods from the ohmmeter are first connected to the transistor leads and then the test lead connections are reversed. Thus, the effects of the polarity reversal of the voltage applied from the ohmmeter to the transistor can be observed.

Field Effect Transistor Checks. Field Effect Transistors (FET's) can be checked in the same manner as other transistors. However, it should be noted that normal operation in the 7A13 has the gate-to-source junction reverse biased just as the control grid-to-cathode is biased in vacuum tubes.

Diodes. A diode can be checked for an open or for a short circuit by measuring the resistance between terminals with an ohmmeter set to the R X 1 k scale. The diode resistance should be very high in one direction and very low when the meter leads are reversed. Do not check tunnel diodes or back diodes with an ohmmeter.

A. RESISTORS

Resistors can be checked with an ohmmeter. Check the Electrical Parts List for the tolerance of the resistors used in this instrument.

B. CAPACITORS

A leaky or shorted capacitor can be detected by checking the resistance with an ohmmeter on the highest scale. Do not exceed the voltage rating of the capacitor. The resistance reading should be high after the initial charge of the capacitor. An open capacitor can be detected using a capacitance meter or by checking whether the capacitor passes AC signals.

C. RELAYS

The relays which are plugged into the circuit board may be removed and checked. The lead configuration is shown on the side of the relay cover. Using an ohmmeter, check for the indicated resistance. The relay may be actuated by applying 15 volts DC to the relay coil. With the relay actuated, check the normally-open contacts for continuity.

8. Repair and Readjust the Circuit. If any defective parts are located, follow the replacement procedures given in this section. Be sure to check the performance of any circuit that has been repaired or had any electrical components replaced.

Table 4-3
RECALIBRATION AFTER REPAIR

Areas of Repair	Checks & Adjustments Affected	Section 5 Calibration Step
Input Mode Switches Input Attenuators	Input R and C, attenuator compensation, CMRR low-frequency response	Steps 12 through 16. Steps 18, 19, 21, 22.
Input Amplifier	DC adjustments, gain CMRR, high-frequency compensation, noise and recovery	Steps 1 through 9. Steps 11, 17, 20, 25, 32, 36
Output Amplifier	DC adjustments, gain, CMRR, high-frequency compensation, noise and recovery	Steps 1 through 9. Steps 17, 20, 25, 26, 32, 36.
Trigger Amplifier	Gain, high-frequency response	Steps 17 and 20. Steps 23 through 24.
Comparison Voltage	Comparison Voltage	Steps 27 through 34.

CORRECTIVE MAINTENANCE

General

Corrective maintenance consists of component replacement and instrument repair. Special techniques required to replace components in this instrument are given here.

Obtaining Replacement Parts

Standard Parts. All electrical and mechanical part replacements for the 7A13 can be obtained through your local Tektronix Field Office or representative. However, many of the electronic components can be obtained locally in less time than is required to order them from Tektronix, Inc. Before purchasing or ordering replacement parts, check the parts list for value, tolerance, rating and description.

NOTE

When selecting replacement parts, it is important to remember that the physical size and shape of a component may affect the performance of the instrument, particularly at high frequencies. All replacement parts should be direct replacements unless it is known that a different component will not adversely affect instrument performance.

Special Parts. In addition to the standard electronic components, some special parts are used in the 7A13. These parts are manufactured or selected by Tektronix, Inc. in accordance with our specifications. These special parts are indicated in the parts list by an asterisk preceding the part number. Most of the mechanical parts used in this instrument have been manufactured by Tektronix, Inc. Order all special parts directly from your local Tektronix Field Office or representative.

Ordering Parts. When ordering replacement parts from Tektronix, Inc., include the following information:

1. Instrument Type.
2. Instrument Serial Number.
3. A description of the part (if electrical, include circuit number).
4. Tektronix Part Number.

Soldering Techniques

WARNING

Disconnect the instrument from the power source before soldering.

The reliability and accuracy of this instrument can be maintained only if proper soldering techniques are used when repairing or replacing parts. General soldering techniques which apply to maintenance of any precision electronic equipment should be used when working on this instrument. Use only 60/40 rosin-core, electronic-grade solder. The choice of soldering iron is determined by the repair to be made. When soldering on circuit boards (other than attenuator circuit boards), use a 35 to 40-watt pencil-type soldering iron with a 1/8-inch wide, wedge-shaped tip. Keep the tip properly tinned for best heat transfer to the solder joint. A higher wattage soldering iron may separate the wiring from the base material. When soldering on attenuator circuit boards (made from polyphenylene oxide), use a very small soldering iron, not over 15 watts. Avoid excessive heat; apply only enough heat to remove the component or to make a good solder joint. Also, apply only enough solder to make a firm solder joint; do not apply too much solder.

For metal terminals (e.g., switch terminals, potentiometers, etc.), a higher wattage-rating soldering iron may be required. Match the soldering iron to the work being done. For example, if the component is connected to the chassis or other large heat-radiating surface, it will require a 75-watt or larger soldering iron. The pencil-type soldering iron used on the circuit board can be used for soldering to switch terminals, potentiometers, or metal terminals mounted in plastic holders.

Component Replacement

WARNING

Disconnect the equipment from the power source before replacing components.

Relay Replacement. The relays in the 7A13 are manufactured by Tektronix, Inc. If a relay fails, a replacement may be ordered from your local Tektronix Field Office or representative. The eight-pin DPDT relays are symmetrical and may be replaced in their sockets facing either direction. Relays which are not symmetrical can be replaced in only one direction. See the lead configuration on the side of the relay cover.

Semiconductor Replacement. Transistors should not be replaced unless actually defective. If removed from their sockets during routine maintenance, return them to their original sockets. Unnecessary replacement of transistors may affect the calibration of this instrument. When transistors are replaced, check the performance of the part of the instrument which may be affected.

Replacement semiconductors should be of the original type of a direct replacement. Fig. 4-2 shows the lead configuration of the semiconductors used in this instrument. If the replacement semiconductor is not of the original type, check the manufacturer's basing diagram for proper basing.

Interconnecting Pins and Pin Socket Replacement. Two types of mating connectors are used for these interconnecting pins. If the mating connector is mounted on a plug-on circuit board, a special socket is soldered onto the board. If the mating connector is on the end of a lead, a pin connector is used to mate with the interconnecting pin. The following information provides the replacement procedure for the various types of pins and pin sockets:

A. CIRCUIT BOARD PINS

NOTE

A pin replacement kit including necessary tools, instructions and replacement pins is available from Tektronix, Inc. Order Part No. 040-0542-00.

To replace a pin which is mounted on a circuit board, first disconnect any pin connectors. Then, unsolder the damaged pin and pull it out of the circuit board. Observe the precautions given under Soldering Techniques to prevent damage to the circuit board. Ream out the hole in the circuit board with a 0.031inch drill. Remove the ferrule from the new interconnecting pin and press the new pin into the hole in the circuit board. Position the pin in the same manner as the old pin. Solder the pin on both sides of the circuit board. If the old pin was bent at an angle to mate with a connector, bend the new pin to match the associated pins.

B. CIRCUIT BOARD PIN SOCKETS

The pin sockets on the circuit boards are soldered on the rear of the board. To replace one of these sockets, first unsolder the pin (use a vacuum-type desoldering tool to remove excess solder). Straighten the tabs on the socket and remove it from the board. Place the new socket in the circuit board hole and press the tabs down against the board. Solder the tabs to the circuit board. Do not allow the solder to get into the socket.

NOTE

The spring tension of the pin sockets ensures a good connection between the circuit board and the pin. This spring tension can be destroyed by using the pin sockets as a connecting point for spring-loaded probe tips, alligator clips, etc.

C. END LEAD PIN CONNECTORS

The pin connectors used to connect the wires to the interconnecting pins are clamped to the ends of the associated leads. To replace damaged end-lead pin connectors, remove the old pin connector from the end of the lead and clamp the replacement connector to the lead.

Some of the pin connectors are grouped together and mounted in a plastic holder. These connectors are referred to as multi-pin connectors and are removed and re-installed as a unit. To provide correct orientation of this multi-pin connector when it is replaced, an arrow is stamped on the circuit board and a matching arrow is molded into the plastic housing of the multi-pin connector. Align these arrows when replacing the multi-pin connector. If individual end-lead pin connectors are removed from the plastic holder, note the color of the wire for replacement.

Circuit Board and Pushbutton Switch Replacement. If a circuit board is damaged beyond repair, either the entire assembly including all soldered-on components, or the board only, can be replaced. Part numbers are given in the Mechanical Parts List for either the wired or unwired board.

Components which are mounted on the circuit board associated with the pushbutton switch can be replaced using the normal replacement procedures. See the information under Light-Bulb Replacement for instructions on replacing the light bulbs.

Switch Replacement

Various types of manually-operated switches are used in the 7A13. If a switch other than an illuminated pushbutton type is damaged, it should be replaced as a unit. The illuminated pushbutton switches are attached to a circuit board assembly. The replacement of one of these switches requires replacement of the complete assembly. Refer to the Mechanical Parts List for the part number of the assembly.

A defective + or - INPUT Mode switch can usually be repaired by experienced personnel. For further information regarding the possibility of repair or replacement of these switches, contact your local Tektronix Field Office or representative.

Maintenance—7A13 (SN B200000-up)

Observe the soldering precautions given previously in this section when replacing a switch. Use the exploded view in the rear portion of this manual as a guide when removing and reassembling mechanical parts. The following replacement information is provided.

+ and – INPUT Switch. Use the following procedure when replacing the switches.

1. Remove all knobs except the release latch knob. To remove the V_c REF-IDENT pushbutton knob, first loosen the POSITION knob setscrew and then pull off the POSITION knob. The V_c REF-IDENT knob will slide off at the same time.

2. Remove the Gnd connector assembly using a 3/8-inch wrench.

3. Remove the V_c OUT 0-10 V jack by unsoldering the cable wire lead and the capacitor connected to it. Then, use a 5/16-inch wrench to loosen the jack at the front panel location. Use a small screwdriver as a wedge to hold the rear mounting nut stationary as a jack is loosened for removal. Remove the jack.

4. Pull the release latch outward to allow removal of the front panel. Remove the front panel, the $R_{in \approx \infty}$ indicator light lens and the VOLTS counter lens holder assembly.

NOTE

The $R_{in \approx \infty}$ indicator light lens and the VOLTS Counter lens holder assembly fit loosely in the sub panel. Hold the 7A13 with the front facing upward to prevent these parts from falling out while removing the front panel.

5. Remove the Attenuator electrical shield cover by removing the two screws that hold it in place.

6. Unsolder the three Attenuator wires where they attach to the front end of the Input board.

7. Unsolder the capacitors and leads where they are attached to the BNC INPUT connectors.

NOTE

To make removal of the Attenuator board assembly easier, the .019 μ F coupling capacitors should be completely removed.

8. Make a color-code wiring sketch of the eight wires that connect to the back side of the Attenuator board. Disconnect these wires from their pin connectors.

9. Remove the screws that hold the +INPUT and –INPUT Mode switches to the front sub panel.

10. Remove the 9/16-inch nuts from the +INPUT and –INPUT BNC connectors.

11. Remove the two screws at the rear end of the Attenuator board that fasten the Attenuator board assembly to the support bracket.

12. Lift the Attenuator board assembly (includes the electrical shield fastened to the board) out of the plug-in unit.

13. Replace the defective switch by replacing the complete board with switches attached. Be sure to save parts, such as the shield and switch lamp housings, that must be transferred to the new board. Reverse the order of the above procedure to re-install the Attenuator board assembly, front panel, knobs and other parts that have been removed.

NOTE

When replacing the Attenuator board assembly, first install the screws that hold the pushbuttons to the front sub panel. This ensures that the pushbuttons will be centered in their respective square holes to prevent rubbing or binding when they are operated.

BW or Polarity Switches. The procedure is as follows:

1. Perform steps 1 through 4 of the +INPUT Mode Switch replacement procedure.

2. Disconnect the multi-pin connectors from the switch circuit board.

3. Remove the front-panel screw that holds the switch and circuit board assembly.

4. Remove the switch with its circuit board.

5. Replace the switch and circuit board assembly.

6. To re-install the assembly, reverse the order of the above procedure.

VOLTS/DIV Switch. Use the following removal information as a guide.

1. Set the PULL VAR FOR X10 V_c Range knob to its outward position. Remove the VOLTS/DIV and VARIABLE knobs.

2. Make a color code wiring sketch of the VOLTS/DIV switch wires. Unsolder the wires.

3. Loosen the three setscrews that hold the VARIABLE control shaft couplings to the VARIABLE control plastic extension shaft. (Do not loosen the setscrew in the plastic half coupling attached to the VARIABLE control drive shaft, but do loosen the setscrew in the front half of this two-piece plastic coupling.)

4. Slide the front half of the plastic coupling forward.

5. Remove the plastic extension shaft with its couplings.

6. Loosen the four 3/16-inch nuts on the VOLTS/DIV switch that hold the rear end of the switch to the support bracket.

7. Remove the 7/16-inch front panel nut from the VOLTS/DIV switch.

8. Loosen the nuts on the PULL VAR FOR X10 Range slide switch until they are located near the end of their mounting studs. Lift the slide switch to allow removal of the slide switch coupling off the variable control metal extension shaft. Remove the slide switch coupling.

9. Loosen the setscrew in the VARIABLE control shaft collar. Slide the collar off the metal extension shaft.

10. Remove the two VARIABLE control extension shaft retaining rings located on each side of the rotary switch stop.

11. Remove the switch.

12. When replacing the switch, check that the plastic extension shaft extends about 1/16-inch into the plastic half coupling fastened to the VARIABLE control. This enables the shaft to slide smoothly into the coupling when the PULL VAR FOR X10 Range knob is pushed in.

Light-Bulb Replacement. To replace light bulbs in the pushbutton switches, proceed as follows:

1. Remove the applicable pushbutton switch, using the previously described procedure.

2. Remove the screw which holds the metal cover on the back of the switch to expose the light bulb.

3. Note the position of the bulb on the switch. Unsolder the defective bulb from the circuit board.

4. Install the new bulb so it is positioned in the same manner as the original bulb.

5. Solder the bulb to the circuit board. If possible, use a heat sink to protect the bulb during soldering.

6. Replace the metal cover on the switch.

7. Re-install the switch using the previously described procedure.

REPACKAGING FOR SHIPMENT

If the Tektronix instrument is to be shipped to a Tektronix Service Center for service or repair, attach a tag showing: owner (with address) and the name of an individual at your firm that can be contacted, complete instrument serial number and a description of the service required.

Save and re-use the package in which your instrument was shipped. If the original packaging is unfit for use or not available, repackage the instrument as follows:

1. Obtain a carton of corrugated cardboard having inside dimensions of no less than six inches more than the instrument dimensions; this will allow for cushioning. Refer to the following table for carton test strength requirements.

2. Surround the instrument with polyethylene sheeting to protect the finish of the instrument.
3. Cushion the instrument on all sides by tightly packing dunnage or urethane foam between carton and instrument, allowing three inches on all sides.
4. Seal carton with shipping tape or industrial stapler.

SHIPPING CARTON TEST STRENGTH

Gross Weight (lb)	Carton Test Strength (lb)
0-10	200
10-30	275
30-120	375
120-140	500
140-160	600

PERFORMANCE CHECK/CALIBRATION

Introduction

To assure instrument accuracy, check the calibration of the 7A13 every 1000 hours or every six months if used infrequently. Before calibration, thoroughly clean and inspect this unit as outlined in the Maintenance section.

The Performance Check/Calibration Procedure can be used to check instrument performance without removing the side covers or making internal adjustments by performing everything except the ADJUST part of the steps. Screwdriver adjustments which are accessible without removing the covers are adjusted as part of the performance check procedure. Steps 1 through 7, and 12 through 16, are Calibration Procedure Only steps and therefore should be excluded when making a performance check.

Completion of each step in the complete Performance Check/Calibration Procedure ensures that this instrument meets the electrical specifications given in Section 1. For best overall instrument performance when performing a complete calibration procedure, make each adjustment to the exact setting even if the CHECK is within the allowable tolerance.

A Short-Form Procedure is given prior to the complete procedure. To facilitate instrument calibration for the experienced calibrator, the Short-Form Procedure lists the calibration adjustment necessary for each step and the applicable tolerances. This procedure also includes the step number and title as listed in the complete Performance Check/Calibration Procedure and the page number on which each step begins. Therefore, the Short-Form Procedure can be used as an index to locate a step in the complete procedure. This procedure may be reproduced and used as a permanent record of instrument calibration.

NOTE

All waveforms shown in this procedure were taken with a Tektronix Oscilloscope Camera System using a projected graticule. Limits, tolerances and waveforms in this procedure are given as calibration guides and should not be interpreted as instrument specifications except as stated in Section 1.

A partial calibration is often desirable after replacing a component, or to touch up an adjustment of a particular circuit between major recalibrations. For partial calibration, set the controls as given under Preliminary

Procedure and start with the nearest test equipment list preceding the desired check or checks. If any controls need to be changed from the preliminary settings for this portion of the calibration procedure, they are listed under "Control Settings" near the equipment-required list. To prevent unnecessary recalibration of other parts of the instrument, readjust only if the tolerances given in the CHECK part of the step is not met. If readjustment is necessary, also check the calibration of any steps listed in the INTERACTION part of the step.

TEST EQUIPMENT REQUIRED

The following test equipment and accessories, or their equivalents, are required for complete calibration of the 7A13. Specifications given for the test equipment are the minimum necessary for accurate calibration. Therefore, some of the specifications listed here may differ from the actual performance capabilities of the test equipment. All test equipment is assumed to be correctly calibrated and operating within the listed specifications. Detailed operating instructions for the test equipment are not given in this procedure. Refer to the test equipment instruction manual if more information is needed.

If only a Performance Check procedure is performed, not all of the listed test equipment will be required. Items used only for the Calibration Procedure are indicated by footnote 1. The remaining pieces of equipment are items common to both the Performance Check and the Calibration Procedure.

Special Calibration Fixtures

Special Tektronix calibration fixtures are used only where they facilitate instrument calibration. These special calibration fixtures are available from Tektronix, Inc. Order by part number through your local Tektronix Field Office or representative.

Calibration Equipment Alternatives

Test equipment listed in the Examples of Applicable Test Equipment column, Table 5-1, is required to perform performance check and calibrate this instrument. If other equipment is substituted, control settings or calibration setups may need to be altered. If the exact item of equipment given as an example is not available, refer to the specifications column to determine if other equipment may be substituted.

Performance Check/Calibration—7A13 (SN B200000-up)

TABLE 5-1
Test Equipment and Accessories

Description	Minimum Specifications	Purpose	Examples of Applicable Test Equipment
1. Calibration Oscilloscope	Tektronix 7000-series mainframe. Minimum system bandwidth (Vert. and Plug-in, plus mainframe): 100 MHz.	Used throughout procedure to provide a display.	1. Tektronix 7904 Oscilloscope. ¹ 2. Tektronix 7704A Oscilloscope. ¹
2. Time-Base Plug-In	Tektronix 7B-series plug-in unit. Fastest sweep rate: 0.1 μ s/div.	Used throughout procedure to provide sweep.	Tektronix 7B50 Time Base Plug-In.
3. Pulse Generator	Risetime: 250 ps or less. Amplitude: adjustable from 80 mV to 40 V into a 50 Ω load. Repetition rate; preset between 500 ps and 720 ps (using two charge lines).	Used for steps 17 and 23.	Tektronix Type 109 Pulse Generator.
4. Square-Wave Generator (Calibration Generator)	Repetition rate: approximately 1 kHz; risetime: approximately 0.5 μ s; amplitude: 0.5 V to 12 V into 50 Ω .	Used for steps 12, 17, 18, 19, 20, 21, 22, and 23.	a. Tektronix PG506 Calibration Generator. ² b. Tektronix 106 Square-Wave Generator.
5. Low-Frequency Sine-wave Generator	Frequency, 30 Hz to 50 kHz; output amplitude, variable from 200 mV to 8 V.	Low-frequency triggering checks and adjustments.	a. Tektronix FG503 Function Generator. ² b. General Radio 1310-B Oscillator.
6. Medium-Frequency Sine-Wave Generator	Frequency, 20 MHz to 100 MHz; output amplitude, variable from 100 mV to 500 mV.	100 megahertz triggering checks.	a. Tektronix SG503 Sine-Wave Generator. ² b. Tektronix Type 191 Sine-Wave Generator.
7. Precision DC Voltmeter	Range: 100 mV to 10 V. Accuracy: 0.02% or better.	Used for steps 12 30, 31 and 32.	John Fluke Differential Voltmeter, Model 825A.

¹Used for calibration only; NOT used for performance check.

²Requires a TM500-Series Power Module.

TABLE 5-1 (cont)

Description	Minimum Specifications	Purpose	Examples of Applicable Test Equipment
8. Overdrive Recovery Test Fixture	Reed switch with drive coil for switching 15 volts externally applied.	Used for Step 36.	Tektronix Part No. 067-0608-00.
9. DC Voltmeter (VOM) ¹	Sensitivity, less than 2 volts full scale.	Used for steps 4, 5, 6, and 7.	a. Triplett 630-NA. b. Simpson 262.
10. Precision DC Divider	Attenuation: 10X and 100X. Accuracy: $\pm 0.01\%$.	Used for steps 12, 13, 14, and 15.	Tektronix Type 067-0503-00.
11. RC Normalizer	RC Time constant: 1 M Ω X 20 pF.	Used for step 18.	Tektronix Type 067-0538-00.
12. Plug-In Extender ¹	Provides access to 7A13 adjustments.	Used throughout procedure to provide access to internal adjustments and test points.	Tektronix Part 067-0589-00 Calibration Fixture.
13. Long Charge Line (60 ns)	Length: 60 ns. Impedance 50 Ω $\pm 1\%$. Cable quality, approximately 1.5 dB loss per 100 feet at 1 GHz.	Used for steps 17, 23, 24, 25, and 26.	Tektronix 7M11 Delay Line.
14. Short Charge Line (Optional)	Length: 3.45 ns. Impedance: 50 Ω . GR connector on one end, other end open.	Used for steps 17, 23, 24, 25, and 26.	Made from Tektronix Part No. 017-0505-00 cut to length. Approximately 14-1/8 inches long.
15. 5 ns Cable (2)	Delay: 5 ns; connectors: GR; impedance: 50 Ω .	Used for steps 17 and throughout for signal connection.	Tektronix Part No. 017-0502-00.
16. 42-inch Cable	Connector: BNC; impedance: 50 Ω .	Used throughout procedure for signal connection.	Tektronix Part No. 012-0057-01.
17. 6-inch Patch Cord	Connector: BNC plug and jack on one end; red and black banana plug and jack on other end.	Used for steps 12, 13, 14, and 15.	Tektronix Part No. 012-0088-00 — RED 012-0089-00 — BLACK
18. 6-inch Patch Cord (2)	Connector; banana plug and jack on each end.	Used for steps 12, 13, 14, and 15.	Tektronix Part No. 012-0023-00 — BLACK 012-0024-00 — RED
19. 5-inch Patch Cord	Connector: probe ground lead, and a probe spring clip.	Used for steps 10 and 11.	Tektronix Part No. 175-0124-01 (ground lead) 206-0060-00 (spring clip)

¹Used for calibration only; NOT used for performance check.

Performance Check/Calibration—7A13 (SN B200000-up)

TABLE 5-1 (cont)

Description	Minimum Specifications	Purpose	Examples of Applicable Test Equipment
20. Termination	Impedance: 50 Ω; GR to BNC male; accuracy, ±2%.	Used throughout procedure.	Tektronix Part No. 017-0083-00.
21. 10X Attenuator (2)	Impedance: 50 Ω; connector: GR; accuracy, ±2%.	Used for step 17 and when necessary for attenuation.	Tektronix Part No. 017-0078-00.
22. 5X Attenuator	Impedance: 50 Ω; connector: GR; accuracy, ±2%.	Used for step 28 and when necessary for attenuation.	Tektronix Part No. 017-0079-00.
23. Adapter	Connectors: GR to BNC male.	Used throughout procedure.	Tektronix Part No. 017-0064-00.
24. Adapter	Connectors: GR to BNC female.	Used throughout procedure.	Tektronix Part No. 017-0063-00.
25. Adapter	Connectors: BNC female to clip leads.	Used for steps 12, 13, 14, and 15.	Tektronix Part No. 013-0076-00.
26. Adapter	Connectors: Dual binding post to BNC male.	Used for step 13.	Tektronix Part No. 103-0035-00.
27. Flexible T Connector	Connectors: BNC male.	Used for steps 20, 21, and 22.	Tektronix Part No. 067-0525-01.
28. Resistor	Fixed, 1 megohm 1/2 or 1/4 W 1%.	Used for steps 12, 13, 14, and 15.	Tektronix Part No. 323-0481-00 (1/2 W).
29. Screwdriver	Three-inch shaft, 3/32 inch bit.	Used to adjust variable resistors.	Xcelite R3323.
30. Low Capacitance Screwdriver ¹	All plastic rod; 5-inches long.	Used to adjust variable capacitors.	Tektronix Part No. 003-0301-00.
31. Alignment Tool	All plastic rod; removable tips.	Used to adjust variable capacitors.	Tektronix Part No. 003-0307-00, Handle. 003-0308-00, Wire Pin Insert. 003-0334-00, Screwdriver Tip.

¹Used for calibration only; NOT used for performance check.

INDEX AND SHORT-FORM PERFORMANCE CHECK/CALIBRATION PROCEDURE

This short-form procedure is intended to be used for inspection and periodic calibration checks to confirm that the 7A13 is operating within acceptable limits. This procedure is concerned with those portions of the instrument calibration that are essential to measurement accuracy and correct operation.

The step numbers and titles used here correspond to those used in the complete procedure, and also serve as an index to locate that step.

Performance requirements that are listed after the word "Requirement" correspond to those given in Section 1. The tolerances, when given after the word "Check", are given as a guide to check the 7A13 for correct operation and are not instrument specifications.

DC and GAIN ADJUSTMENTS

1. Check/Adjust Position Center (R335) Page 5-10
and DC Balance (R173)

CHECK—Trace positioned within ± 1 division of graticule center and no trace shift as VARIABLE (VOLTS/DIV) control is rotated.

2. Check/Adjust Step Atten DC Bal (R288) Page 5-11

CHECK—No trace shift as VOLTS/DIV switch is switched from 10 mV to 50 mV.

3. Check/Adjust 10X DC Bal (R307) Page 5-11

CHECK—No trace shift as VARIABLE knob is pulled to its outward position.

INTERACTION—Repeat step 2.

4. Check/Adjust Position Center (R335) Page 5-11
final adjustment)

CHECK—Voltmeter reading of 0 volts between TP360 and TP460.

5. Check/Adjust Trigger DC Balance Page 5-12
(R371)

CHECK—Voltmeter reading of 0 volts between TP380 and TP480.

INTERACTION—Repeat step 4 and then step 5.

6. Check/Adjust Signal Output DC Level Page 5-12
(R360)

CHECK—Voltmeter reading of 0 volts between TP360 and chassis ground.

7. Check/Adjust Trigger Output DC Level Page 5-12
(R380)

CHECK—Voltmeter reading of 0 volts between TP380 and ground.

8. Check/Adjust Gain (R329 front panel) Page 5-12

REQUIREMENT—Four divisions vertical deflection at 10 mV/div with 40 mV peak-to-peak 1-kHz square-wave input.

9. Check Gate Current Page 5-12

REQUIREMENT—Trace shift should not exceed 0.2 division (0.2 mV or 0.2 nA) as the + or - INPUT Mode switch is set from GND to AC. A 50-ohm termination is connected to the input being checked. Check both inputs.

PRELIMINARY COMPARISON VOLTAGE CHECK & THERMAL COMPENSATION ADJUSTMENT

10. Check Comparison Voltage Page 5-14

CHECK—With 10 volts applied from the 7A13 V_c OUT 0-10 V jack to the + INPUT connector trace deflection should be 5 divisions within ± 0.5 division when the VOLTS/DIV switch is set to 2 V and the + INPUT switch is set to DC.

11. Check/Adjust Overdrive Thermal Page 5-14
Compensation (R167)

CHECK—With 10 volts applied to the 7A13 input circuit via the V_c position of the + or - INPUT Mode switch the trace should return quickly (within one second or less) to graticule center within 0.5 division or less at 1 mV/div, when the appropriate INPUT Mode switch is set to GND. Check both inputs.

INPUT RESISTANCE & DC ATTENUATION RATIO ADJUSTMENTS

12. Check/Adjust + INPUT 10X DC Attenuation Ratio (R8G) Page 5-16

CHECK—Trace shift should not exceed ± 0.3 division. See procedure for details.

13. Check/Adjust + INPUT 1X DC Input Resistance (R7) Page 5-17

CHECK—For a null indication within 5 mV on the voltmeter. See procedure for details.

INTERACTION—Repeat step 12.

14. Check/Adjust + INPUT 100X DC Attenuation Ratio (R5E) Page 5-18

CHECK—Trace shift should not exceed ± 0.3 division. See procedure for details.

15. Check/Adjust - INPUT 10X Attenuation Ratio (R28G) Page 5-18

CHECK—Trace shift should not exceed ± 0.3 division. See procedure for details.

16. Check/Adjust - INPUT 1X DC Input Resistance (R27) Page 5-19

CHECK—For a null indication within 5 mV on the voltmeter. See procedure for details.

INTERACTION—Repeat step 15.

HIGH-FREQUENCY COMPENSATION ADJUSTMENTS

17. Check/Adjust High-Frequency Compensation (R196, R432, R336, R333, C187, R187, C163, C113, C150, C250, C213; both inputs) Page 5-20

REQUIREMENT—System risetime of 3.5 nanoseconds or less for all VOLTS/DIV switch positions. Check both inputs.

CHECK—System aberrations using Table 5-4 in the procedure as a guide. Check both inputs.

ATTENUATOR COMPENSATION ADJUSTMENTS

18. Check/Adjust + INPUT Attenuator Compensation (C14, C8A, C8B, C5A, C5B) Page 5-26

CHECK—Optimum square corner and flat top within $\pm 1\%$ or ± 0.06 division for a 6-division peak-to-peak display. Refer to Table 5-5.

19. Check/Adjust - INPUT Attenuator Compensation (C34, C28A, C28B, C25A, C25B) Page 5-28

CHECK—Optimum square corner and flat top within $\pm 1\%$ or ± 0.06 division for a 6-division peak-to-peak display. Refer to Table 5-6.

COMMON-MODE ADJUSTMENTS

20. Check/Adjust Amplifier High-Frequency Common-Mode Rejection (C124, C224, C134, C234) Page 5-30

REQUIREMENT—With the VOLTS/DIV switch set at 1 mV, check the common mode difference signal peak-to-peak amplitude using the sequence provided in the following chart.

Sine-Wave Input Signal	Requirement	
	P-P Display Amplitude	CMRR
1 MHz, 10 V	1 mV or less	10,000:1
10 MHz, 1 V	2 mV or less	500:1
20 MHz, 1 V	5 mV or less	200:1
100 kHz, 20 V	1 mV or less	20,000:1

INTERACTION—Repeat step 17 and then step 20.

21. Check/Adjust Attenuator Common-Mode Rejection at 100 Hz (R28G, R5E) Page 5-31

REQUIREMENT—With a 100 Hz 50-volt square-wave signal applied, peak-to-peak display amplitude should be 0.25 division (25 mV) or less with VOLTS/DIV switch set to .1 V; 1/8 of a minor division (25 mV) or less with VOLTS/DIV switch set to 1 V. This is equivalent to a CMRR of 2,000:1.

22. Check/Adjust Attenuator Common-Mode Rejection at 10 kHz (C28A, C25A) Page 5-32

REQUIREMENT—With a 10 kHz 50-volt sine-wave signal applied, peak-to-peak display amplitude should be 0.25 division (25 mV) or less with VOLTS/DIV switch set to .1 V; 1/8 of a minor division (25 mV) or less with VOLTS/DIV switch set to 1 V. This is equivalent to a CMRR of 2,000:1.

TRIGGER AND SIGNAL AMPLIFIER RESPONSE CHECKS (including a trigger gain check)

23. Check Trigger Amplifier Gain and Step Response Page 5-34

CHECK—Using the 6-division signal amplifier waveform as a reference, the trigger waveform display should be within 15% (± 0.9 division) of the signal waveform.

CHECK—System risetime, with the trigger amplifier connected into the system, should be about 0.1 of a nanosecond slower than the risetime obtained when the signal amplifier is connected into the system.

CHECK—System aberration, with the trigger amplifier connected into the system, should be no greater than +4%, -4%, or a total that does not exceed 6% peak to peak.

24. Check Trigger Amplifier Sine Wave Response; Full and 5 MHz Page 5-35

CHECK—High-Frequency response should not be more than -3 dB at 100 MHz.

CHECK—Upper frequency response limit should be -3 dB at 5 MHz within 500 kHz.

25. Check Signal Amplifier High-Frequency Response Page 5-37

REQUIREMENT—High frequency response should be not more than -3 dB at 100 MHz.

26. Check Signal Amplifier 5 MHz Bandwidth Sine Wave Response Page 5-37

REQUIREMENT—Upper frequency response limit should be -3 dB at 5 MHz within 500 kHz.

COMPARISON VOLTAGE ADJUSTMENTS

27. Check/Adjust $+V_C$ Zero (R696) Page 5-38

CHECK—Trace should be 1 division below midscreen.

28. Check/Adjust $-V_C$ Zero (R720) Page 5-38

CHECK—Trace should be 1 division above midscreen.

29. Check/Adjust DVM Zero (R708) Page 5-38

CHECK— V_C reading should alternate between 0.000 and 0.001.

30. Check/Adjust $+V_C$ Cal (R686) Page 5-38

REQUIREMENT—Null reading at +10 volts within a tolerance of ± 0.015 V.

31. Check/Adjust $-V_C$ Cal (R727) Page 5-38

REQUIREMENT—Null reading at -10 volts within a tolerance of ± 0.015 V.

32. Check $+V_C$ Linearity Page 5-39

CHECK—Reading should be in the range of +4.997 to +5.003 volts; see procedure for details.

33. Check—Comparison Voltage Fine Control Range Page 5-39

CHECK—For increased reading by at least 0.030 but no more than 0.040 volts at extreme ends of control; see procedure for details.

34. Check— V_C OUT Resistance Page 5-39

NOISE & OVERDRIVE RECOVERY CHECKS

35. Check Noise Page 5-40

REQUIREMENT—400 μ V or less at 1 mV/div tangentially measured.

36. Check Overdrive Recovery Time Page 5-41

REQUIREMENT—Trace returns to within 2 divisions (2 mV) of graticule center within a recovery time of 1 microsecond after the removal of a +10 volt or -10 volt pulse; trace returns within 1.0 division (1 mV) of graticule center within a recovery time of 0.1 millisecond. Check both inputs.

PERFORMANCE CHECK/CALIBRATION PROCEDURE

General

The following procedure is arranged in a sequence which allows the 7A13 to be calibrated with the least interaction of adjustments and reconnection of equipment. Instrument performance is checked in the "CHECK" part of the step before an adjustment is made. The "ADJUST" part of the step identifies the point where the actual adjustment is made. Steps listed in the "INTERACTION" part of the step may be affected by the adjustment just performed. This information is particularly helpful when only a partial calibration procedure is performed.

NOTE

To prevent recalibration of other parts of the instrument when performing a partial calibration, readjust only if the tolerances given in the "CHECK" part of the step are not met. However, when performing a complete calibration, best overall performance is obtained if each adjustment is made to the exact setting even if the "CHECK" is within the allowable tolerance.

In the following procedure, a test-equipment setup is given for each major group of checks and adjustments. Each step continues from the equipment setup and control settings used in the preceding step(s) unless otherwise noted. If only a partial calibration or performance check is performed, start with the test equipment setup preceding the desired portion. External controls or adjustments of the 7A13 referred to in this procedure are capitalized (e.g., POSITION). Internal adjustment names are initially capitalized only (e.g., Position Center).

All waveforms shown in this procedure are actual waveform photographs taken with a Tektronix Oscilloscope Camera System and Projected Graticule. The following procedure uses the equipment listed under Test Equipment Required. If the equipment is substituted, control settings or test equipment setup may need to be altered to meet the requirements of the equipment used. Detailed operating instructions for the test equipment are not given in this procedure. If in doubt as to the correct operation of any of the test equipment, refer to the instruction manual for that unit.

NOTE

It is assumed that performance is checked within a temperature range of 0° C to +50° C and calibration at +25° C, ±5° C. The tolerances given in this

procedure are for this temperature range. However, if the procedure is performed at some other temperature, check to the applicable tolerances for that temperature range.

PRELIMINARY PROCEDURE

1. Set the 7A13 R_{in} switch, S10 (see Fig. 5-1), to the $R_{in} = 1\text{ M}\Omega$ (counterclockwise) position.
2. (Performance Check only). Insert the 7A13 directly into the Left Vert plug-in compartment of the indicator oscilloscope.
3. (Calibration Procedure only). Remove the left side panel and bottom cover from the indicator oscilloscope. Remove the side covers from the 7A13. Insert the Plug-In Extender between the 7A13 and the connector in the Left Vert plug-in compartment of the indicator oscilloscope.
4. Insert the time-base unit into the B Horiz plug-in compartment of the indicator oscilloscope.
5. Connect the oscilloscope power cord to the operating voltage for which the oscilloscope is wired.

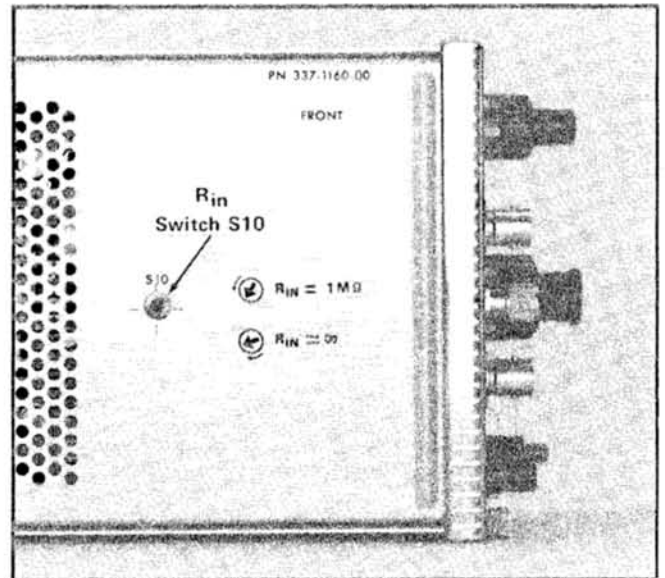

Fig. 5-1. Location of the R_{in} switch S10 on the Attenuator board.

6. Turn on the oscilloscope Power switch. Allow at least 20 minutes warmup before checking the system to the given accuracy. Preset the various front-panel controls to the settings given in the list that follows. This list is also used as a reference for setting the controls when performing a partial Performance Check/Calibration procedure. Hence, the power and R_{in} control settings are included even though these controls have already been preset in steps 1 and 6 of this Preliminary Procedure.

Indicator Oscilloscope

B Intensity Focus	Set for well-defined trace and normal brightness (after plug-in units are installed and power is turned on).
Calibrator	40 mV
Rate (Calibrator)	1 kHz
Vertical Mode	Left
Horizontal Mode	B
B Trigger Source	Left Vert
Power	On (see Preliminary Procedure, step 6)

Controls not listed are considered less important and can be set as desired for performing the procedure.

Time Base Plug-In

Triggering	
Level/Slope	Positive slope region
Mode	P-P Auto
Coupling	AC
Source	Int
Position	Set so that the trace starts at left side of the graticule
Magnifier	X1
Time/Div	0.5 ms
Variable (Time/Div)	Pushed in
Display Mode	Time Base

7A13

COMPARISON VOLTAGE	
(V_c) Polarity	Pushbuttons canceled
VOLTS Display	0.000
(Digits set by V_c COARSE and FINE controls)	
+ INPUT Mode	GND
- INPUT Mode	GND
VOLTS/DIV	10 mV
VARIABLE (VOLTS/DIV)	CAL (clockwise, in detent)
PULL VAR FOR X10 V_c	Pushed in
VAR BAL	Midrange
BW	5 MHz
POSITION	Midrange
R_{in} (internal switch, S10, see Fig. 5-1)	$R_{in} = 1 M\Omega$ (see Preliminary Procedure, step 1)

DC AND GAIN ADJUSTMENTS

Equipment Required

1. Indicator oscilloscope.
2. Time-Base unit.
3. Plug-in extender.
4. DC Voltmeter (VOM).
5. 50 ohm Termination.
6. 50 ohm BNC Coaxial cable (42 inch).
7. Screwdriver.

NOTE
(Performance Check Only)

Steps 1 through 7 are Calibration Procedure Only steps. For a performance check procedure, go to Section 2, Operating Instructions, and perform the Front Panel Adjustments procedure for the VAR BAL, STEP ATTEN BAL, and X10 BAL adjustments. Then start with step 8 (Check/Adjust Gain) in this Performance Check/Calibration procedure to continue checking the performance of the 7A13.

1. Check/Adjust Position Center and DC Balance

- a. Check that the controls are set as given in the Preliminary Procedure.
- b. Set the 7A13 X10 BAL and STEP ATTEN BAL front panel adjustments to the center of their range.
- c. CHECK—For trace positioned within ± 1 division of graticule center.
- d. ADJUST—If trace does not appear on the screen or within ± 1 division of graticule center, adjust the Position Center control R335 (see Fig. 5-2A) to position the trace to graticule center.

NOTE

This is a preliminary adjustment. It is not necessary that the trace appear exactly at graticule center at this time. Final adjustment for R335 occurs in step 4. Leave the front panel POSITION control at midrange until step 7 has been completed.

- e. Rotate the VARIABLE (VOLTS/DIV) control past the detent to its fully counterclockwise position. Note the position of the trace.
- f. CHECK—For no trace shift.

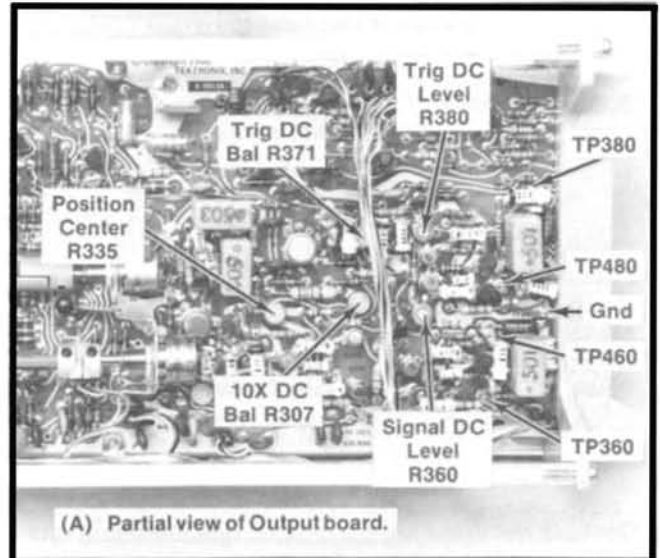

(A) Partial view of Output board.

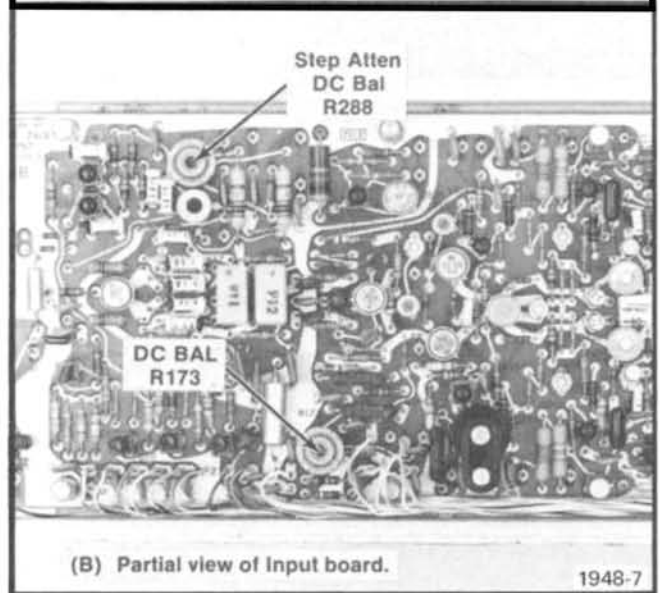

(B) Partial view of Input board.

Fig. 5-2. Waveform display obtained showing correct vertical gain at 1 mV/div. Sweep rate: 0.5 ms/div.

- g. ADJUST—If the trace shifts as the VARIABLE (VOLTS/DIV) control is rotated, note the direction of the shift. Return the control to its CAL (clockwise, in detent) position. If the trace shift is up, adjust the DC Bal control

R173 (see Fig. 5-2B) slightly in a counterclockwise direction until the trace positioned slightly above the location noted in step 1e. If the shift is down, adjust R173 slightly in a clockwise direction to position the trace slightly below the location noted in step 1e.

h. Repeat the procedure in this step until the trace does not shift as the VARIABLE (VOLTS/DIV) control is rotated back and forth throughout its range of rotation.

i. CHECK—As a final check, set the VOLTS/DIV switch to 1 mV. Repeat steps 1e through 1h until there is no trace shift.

NOTE

During the DC Bal adjustment R173 procedure (steps 1e through 1i), it may be necessary to readjust the Position Center control R335 to return the trace to graticule center. Do not use the POSITION control. Instead, use the Position Center control R335 for this purpose.

2. Check/Adjust Step Attenuator DC Balance

a. Check that the front panel STEP ATTEN BAL control is set to midrange and the VARIABLE (VOLTS/DIV) knob is pushed in.

b. Set the VOLTS/DIV switch to 10 mV.

c. Note the position of the trace.

d. Set the VOLTS/DIV switch to 50 mV.

e. CHECK—For no trace shift.

f. If the trace shifts, note the direction of the shift and return the VOLTS/DIV switch to the 10 mV position.

g. ADJUST—If the trace shifted up, adjust the internal Step Atten DC Bal control R288 slightly clockwise. If the trace shifted down, adjust R288 slightly counterclockwise.

h. Repeat the procedure in this step until the trace does not shift in any position of the VOLTS/DIV switch from 10 mV to 5 V.

NOTE

When performing step 2, it may be necessary to readjust the Position Center control R335 to center the trace on the CRT screen.

3. Check/Adjust 10X DC Balance

a. Set the VOLTS/DIV switch to 10 mV.

b. Check that the VARIABLE control is set to the CAL position. Pull the VARIABLE (VOLTS/DIV) knob outward to the X10 V_c position.

c. CHECK—For no trace shift as the VARIABLE knob is pulled to its outward position.

d. ADJUST—If the trace has shifted, note the direction of the shift. Push the VARIABLE knob to its inward position. If the trace shift is up, adjust the internal 10X DC Bal control R307, in a slightly counterclockwise direction. If the trace shift is down, adjust R307 slightly clockwise.

e. Repeat the procedure given in steps 3b through 3d until there is no trace shift as the VARIABLE knob is pulled out and pushed in.

INTERACTION—Repeat steps 1 through 3, as necessary, to obtain proper DC balance.

4. Check/Adjust Position Center (Final Adjustment)

a. Set the VOLTS/DIV switch to 1 mV.

b. Check that the front panel POSITION control is set to midrange.

c. Adjust the internal Position Center control R335 so that the trace coincides with the graticule centerline.

d. Connect a DC voltmeter (VOM), set to its lowest voltage range, from TP360 to TP460 (see Fig. 5-2A). These test points are connected to the 7A13 signal output.

e. CHECK—For a voltmeter reading of 0 volts.

f. ADJUST—To obtain a 0-volt reading, readjust the internal Position Center control R335. This is the final adjustment for R335.

Performance Check/Calibration—7A13 (SN B200000-up)

- g. Disconnect the voltmeter.

5. Check/Adjust Trigger DC Balance

a. Connect the DC voltmeter (VOM), set to its lowest voltage range, from TP380 to TP480 (see Fig. 5-2A). These test points are connected to the 7A13 trigger output.

- b. CHECK—For a voltmeter reading of 0 volts.

c. ADJUST—To obtain a 0-volt reading, adjust the Trig DC Balance control R371 (see Fig. 5-2A).

- d. Disconnect the voltmeter.

e. INTERACTION—Repeat steps 4 and 5 as often as necessary to obtain a 0-volt reading at the signal and the trigger output test points.

6. Check/Adjust Signal Output DC Level

a. With the DC Voltmeter (VOM) set to its lowest voltage range, connect the voltmeter from TP360 to chassis ground. TP360 (see Fig. 5-2A) is the signal output test point. For a chassis ground connection, use the GND test point (see Fig. 5-2A).

- b. CHECK—For a voltmeter reading of 0 volts.

c. ADJUST—To obtain a 0-volt reading, adjust the Signal DC Level control R360 (see Fig. 5-2A).

- d. Disconnect the voltmeter.

- e. INTERACTION—Repeat step 4.

7. Check/Adjust Trigger Output DC Level

a. With the DC voltmeter (VOM) set to its lowest voltage range, connect the voltmeter between TP380 (trigger output test point) and ground. Use the GND test point (see Fig. 5-2A).

- b. CHECK—For a voltmeter reading of 0 volts.

c. ADJUST—To obtain a 0-volt reading, adjust the Trig DC Level control R380.

- d. Disconnect the voltmeter.

- e. INTERACTION—Repeat step 5.

8. Check/Adjust Gain

a. Apply the 40 mV peak-to-peak square wave from the indicator oscilloscope Cal output connector through a 50-ohm coaxial cable to the 7A13 + INPUT connector.

- b. Set the 7A13 controls as follows:

+ INPUT Mode	DC
VOLTS/DIV	10 mV
POSITION	Center the display

c. CHECK—CRT display for exactly 4 divisions of vertical deflection (see Fig. 5-3).

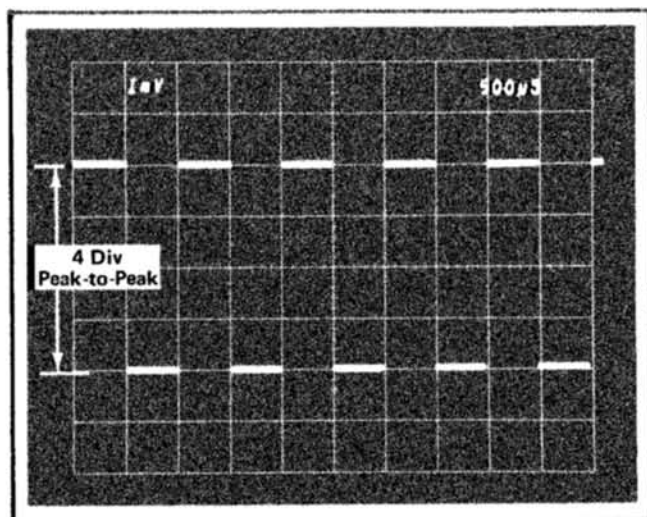

Fig. 5-3. Waveform display obtained showing correct vertical gain at 1 mV/div. Sweep rate 0.5 ms/div.

d. ADJUST—The front panel GAIN control (R329) for exactly 4 divisions of vertical deflection.

NOTE

Performance Check: Since the Gain adjustment is an external control, this control may be adjusted as part of the performance check.

- e. Disconnect the calibrator signal.

9. Check Gate Current

a. Connect a 50-ohm termination to the + INPUT connector.

- b. Set the VOLTS/DIV switch to 1 mV.

c. Check that the + INPUT and - INPUT Mode switches are set to GND.

Performance Check/Calibration—7A13 (SN B200000-up)

d. Using the POSITION control, position the trace to coincide with the graticule centerline.

e. Set the + INPUT switch to AC.

f. CHECK—Amount of trace deflection should not exceed 0.2 division (0.2 mV). This is equivalent to 0.2 nA or less ($0.2 \text{ mV} \div 1 \text{ M}\Omega = 0.2 \text{ nA}$).

g. Move the 50-ohm termination from the + INPUT connector to the - INPUT connector.

h. Set the + INPUT Mode switch to GND and check that the trace is centered.

i. Set the - INPUT Mode switch to AC.

j. CHECK—Amount of trace deflection should not exceed 0.2 division.

k. Remove the 50-ohm termination.

PRELIMINARY COMPARISON VOLTAGE CHECK & THERMAL COMPENSATION ADJUSTMENT

Equipment Required

1. Indicator oscilloscope.
2. Time-Base unit.
3. Plug-in extender.
4. Dual-banana-plug to female BNC adapter.
5. 5 inch patch cord.
6. Screwdriver.

When performing a complete procedure, change the following control settings and proceed with step 10.

	7A13
- INPUT Mode	GND
VOLTS/DIV	2 V
VOLTS Display	999.9

If the remaining controls need to be checked for proper settings or if step 10 is being used as a starting point for partially calibrating the 7A13, refer to the Preliminary Procedure.

10. Check Comparison Voltage

- a. Connect a dual binding post adapter to the + INPUT connector.
- b. Connect 5-inch patch cord from the red binding post on the adapter to the V_C OUT 0-10 V jack.
- c. Using the 7A13 POSITION control, position the trace 3 divisions below graticule center.
- d. Depress the + Polarity pushbutton and set the + INPUT Mode switch to DC.
- e. CHECK—That the trace is deflected 5 divisions from its original position within a tolerance of ± 0.5 division.

NOTE

This is a quick check to be sure that 10 volts will be available for use in performing step 11. The tolerance is given as a guide to check for correct instrument operation and is not an instrument specification.

- f. Set the + INPUT Mode switch to GND.

- b. Disconnect the patch cord and the dual binding post adapter.

11. Check/Adjust Overdrive Thermal Compensation

- a. Set the VOLTS/DIV switch to 1 mV. Check that the VOLTS Display is set to read 9.999.
- b. Using the POSITION control, position the trace to coincide with the graticule centerline.
- c. Set the + INPUT Mode switch to V_C .
- d. CHECK—Set the + INPUT Mode switch to GND and observe that the trace returns quickly (within one second or less) to graticule center within a tolerance of 0.5 mV (0.5 div) or less.

NOTE

The tolerances given in the CHECK and ADJUST procedures for step 11 are guides to check the instrument for correct operation and are not instrument specifications.

- e. ADJUST—If tolerance is exceeded, adjust the Overdrive Thermal Compensation control R167 (see Fig. 5-4) for quickest return of trace (with minimum final trace drift) to within 0.5 mV of graticule center.

- f. Depress the -Polarity pushbutton and set the + INPUT Mode switch to V_C .

- g. CHECK—Set the + INPUT Mode switch to GND and observe that the trace returns quickly (as described in step 12d) to graticule center within a tolerance of 0.5 mV or less.

h. ADJUST—If tolerance is exceeded, readjust the Overdrive Thermal Compensation control R167.

NOTE

It may be necessary to compromise this adjustment setting when performing steps 11b through 11h. The trace should return quickly to its original position within a tolerance of 0.5 mV or less with the Polarity pushbuttons in the + or - positions.

i. Check that the + INPUT Mode switch is set to GND.

j. CHECK—Using step 11b through 11d and steps 11f through 11g as a guide, check the - INPUT circuit of the 7A13. The trace should return quickly to graticule center within a tolerance of 0.5 mV or less as the - INPUT Mode switch is set from V_C to GND for each V_C Polarity switch position.

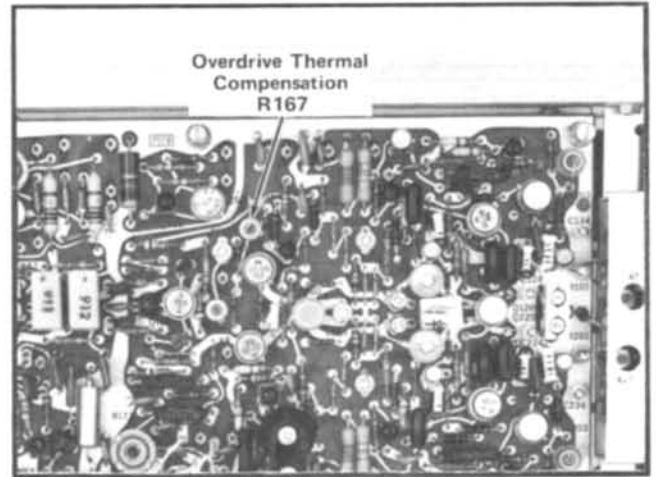

Fig. 5-4. Partial view of Input board showing adjustment location for step 11.

INPUT RESISTANCE & DC ATTENUATION RATIO ADJUSTMENTS

Equipment Required

- | | |
|---|--|
| <ol style="list-style-type: none"> 1. Indicator oscilloscope. 2. Time-Base unit. 3. Plug-in extender. 4. Precision DC divider. 5. Calibration Generator. | <ol style="list-style-type: none"> 6. 42 inch 50 ohm coaxial cable. 7. Precision DC voltmeter. 8. Dual-banana-plug to female BNC adapter. 9. Screwdriver. 10. Alignment tool. 11. Clip lead adapter. |
|---|--|

NOTE

Performance Check Only: Go to step 17.

When performing a complete calibration procedure, change the following control settings and proceed with step 12.

(V _c) Polarity	Pushbutton canceled
— INPUT Mode	GND
VOLTS/DIV	.1 V

If the remaining controls need to be checked for proper settings or if step 12 is being used as a starting point for partially calibrating the 7A13, refer to the Preliminary Procedure except as follows:

VOLTS Display	99.99
---------------	-------

NOTE

The tolerance given in the CHECK and ADJUST procedures for steps 12 through 16 are guides to check the instrument for correct operation and are not instrument specifications.

12. Check/Adjust + INPUT 10X DC Attenuation Ratio

- a. Test equipment setup, for this step is shown in Fig. 5-5.
- b. Connect a 1-megohm 1% resistor from the Precision DC Divider Voltage Output connector to the Precision DC Divider Gnd connector.
- c. Connect a 6-inch patch cord from the 7A13 + INPUT connector to the Precision DC Divider Voltage Input connector (see Fig. 5-5).

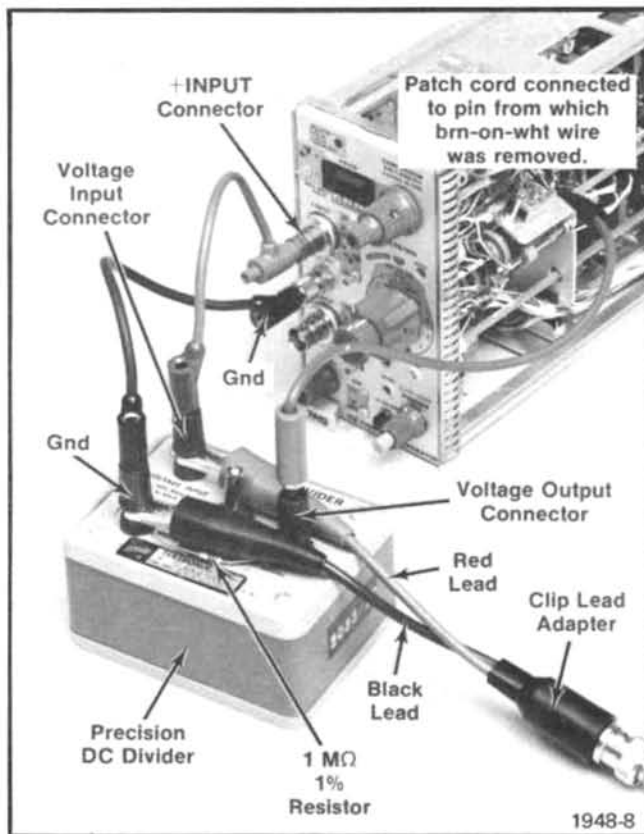

Fig. 5-5. Closeup view of the Precision DC Divider interconnections to the 7A13.

- d. Connect a 6-inch patch cord from the 7A13 Gnd connector to the Precision DC Divider Gnd connector.
- e. Disconnect the 7A13 brown-on-white wire located on the Output board (see Fig. 5-6). This wire disconnects the V_c supply located on the Output board from the V_c input circuit on the Attenuator board but does not disconnect the V_c supply from the V_c OUT 0-10 V jack.

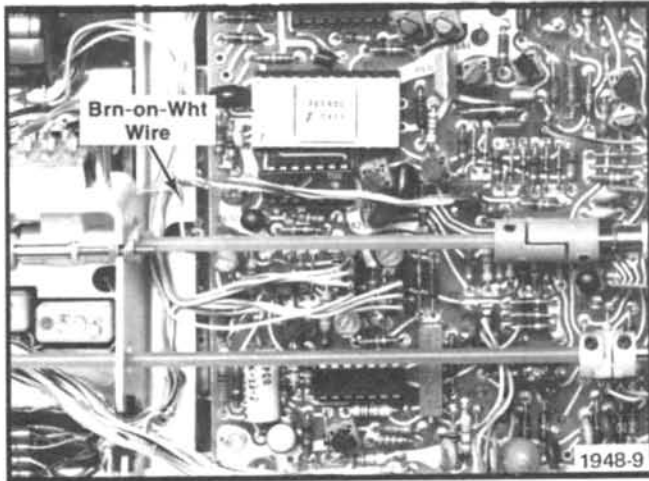

Fig. 5-6. Partial view of Output board showing the V_c input wire and the V_c output pin connector location.

f. Connect a 6-inch patch cord from the Precision DC Divider to the pin from which the brown-on-white wire was disconnected.

CAUTION

Use care when making this connection to prevent the brown-on-white wire from touching chassis ground.

g. Connect a 42-inch 50-ohm coaxial cable to the Calibration Generator AMPL OUTPUT connector. Connect a clip lead adapter to the other end of the cable. Connect the red lead from the clip lead adapter to the Precision DC Divider Voltage Input connector and connect the black lead to the Precision DC Divider Gnd connector. Set the Precision DC Divider switch to 10:1.

h. Set the Calibration Generator AMPLITUDE control to 50 V and the mode switch to STD AMPL.

NOTE

Calibration generator must be set to a dc voltage.

i. Set the + INPUT and - INPUT Mode switches simultaneously to V_c . Using the POSITION control, position the trace to graticule center.

j. CHECK—Set the + INPUT Mode switch to DC and note the trace shift. Amount of trace shift should not exceed ± 0.3 division.

NOTE

The input impedance of the Precision DC Divider lowers the 50 V DC calibrator output to ap-

proximately 18 volts. This is the voltage that is applied to the + INPUT connector. The voltage applied to the brown-on-white lead is exactly one-tenth of the applied voltage at the + INPUT connector.

k. ADJUST—If trace shift exceeds ± 0.3 division, leave the + INPUT Mode switch in the DC position and adjust R8G (see Fig. 5-7) so that the trace is within the given tolerance. Recheck for no trace shift as the + INPUT switch is set from V_c to DC. If necessary, readjust R8G.

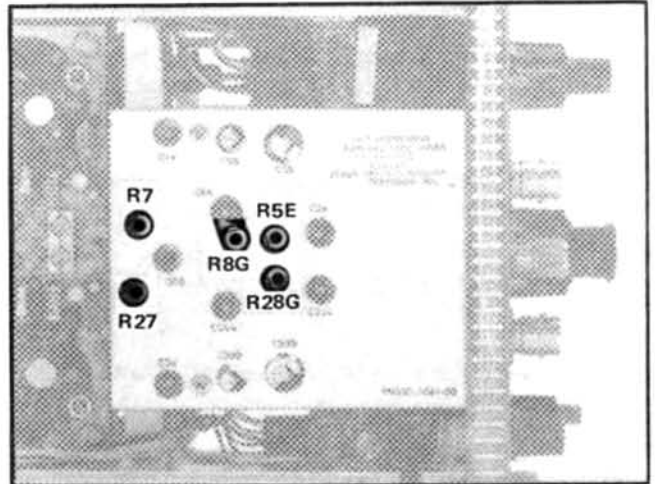

Fig. 5-7. Attenuator board adjustment locations used in the DC Input Resistance and Attenuator Ratio Adjustments procedure.

l. Simultaneously set both + INPUT and - INPUT Mode switches to GND.

m. Disconnect the Precision DC Divider from the 7A13 but leave all other connections unaltered.

n. Leave the brown-on-white wire to the Output board disconnected.

13. Check/Adjust + INPUT 1X DC Input Resistance

a. Connect the dual binding post adapter to the + INPUT connector.

b. Remove the 1 megohm 1% resistor from the Precision DC Divider. Connect the resistor between the red binding post on the adapter and the V_c OUT 0-10 V jack on the 7A13.

Performance Check/Calibration—7A13 (SN B200000-up)

c. Depress the + Polarity pushbutton and set the + INPUT Mode switch to DC.

NOTE

When performing steps 13c through 13i in this procedure, it is normal for the trace to be deflected upward off the CRT.

d. Preset the Precision DC Voltmeter range to measure approximately +5 volts.

e. Connect the Precision DC Voltmeter between the red (+) and the black (ground) binding posts on the adapter.

f. Set the comparison voltage knob for a voltmeter reading of +4.500 volts.

g. Set the VOLTS/DIV switch to 50 mV.

h. CHECK—For a +4.500 volt indication within 5 mV on the voltmeter.

i. ADJUST—If a +4.500 volt reading is not obtained, adjust R7 (see Fig. 5-7) for a +4.500 volt indication on the Precision DC Voltmeter.

j. INTERACTION—If R7 was adjusted, repeat step 12.

k. Disconnect the voltmeter.

l. Cancel the + Polarity pushbutton and set the + INPUT Mode switch to GND.

m. Disconnect resistor and binding post adapter.

14. Check/Adjust + INPUT 100X DC Attenuation Ratio

a. Reconnect the Precision DC Divider in the same manner as was described in step 12. Be sure the 1 megohm 1% resistor is connected from the Precision DC Divider Voltage Output connector to Gnd.

b. Set the VOLTS/DIV switch to 1 V.

c. Set the Precision DC Divider switch to 100:1.

d. Simultaneously set both + INPUT and - INPUT Mode switches to V_c .

e. Using the POSITION control, position the trace to coincide with graticule center.

f. CHECK—Set the + INPUT Mode switch to DC and note the trace shift. Amount of trace shift should not exceed ± 0.3 division.

g. ADJUST—If the tolerance is exceeded, leave the + INPUT Mode switch in the DC position and adjust R5E (see Fig. 5-7) for minimum trace shift.

15. Check/Adjust - INPUT 10X Attenuation Ratio

NOTE

No adjustment is provided for the - INPUT 100X DC attenuation ratio.

a. Simultaneously set both + INPUT and - INPUT switches to GND. Set the VOLTS/DIV switch to .1 V.

b. Move the patch cord from the + INPUT connector to the - INPUT connector. Leave the other end of the patch cord connected to the Precision DC Divider Voltage Input connector.

c. Set the Precision DC Divider switch to 10:1.

d. Simultaneously set both + INPUT and - INPUT switches to V_c .

e. Use the POSITION control to center the trace.

f. CHECK—Set the - INPUT Mode switch to DC and check that the trace shift does not exceed ± 0.3 division.

g. ADJUST—If trace shift exceeds ± 0.3 division, leave the - INPUT Mode switch at DC and adjust R28G (see Fig. 5-7) for minimum trace shift.

h. Disconnect the Precision DC Divider from the 7A13 and indicator oscilloscope. Reconnect the brown-on-white wire to the Output board.

16. Check/Adjust – INPUT 1X DC Input Resistance

- a. Set the front panel controls as follows:

7A13

– INPUT Mode GND

- b. Connect the dual-binding post adapter to the – INPUT connector.

- c. Connect the 1 megohm 1% resistor between the red binding post on the adapter and the V_C OUT 0-10 V jack on the 7A13.

- d. Set the Polarity switch to + and the – INPUT Mode switch to DC.

NOTE

When performing steps 16d through 16k, the trace will be deflected downward off the CRT.

- e. Check that the Precision DC Voltmeter is set to measure +5 volts.

- f. Connect the Precision DC Voltmeter between the red (+) and the black (–) binding posts on the adapter.

- g. Set the comparison voltage knob for a voltmeter reading of +4.500 volts.

- h. Set the VOLTS/DIV switch to 50 mV.

- i. CHECK—For a +4.500 volt indication within 5 mV on the voltmeter.

- j. ADJUST—If a +4.500 volt reading is not obtained, adjust R27 (see Fig. 5-7) for a +4.500 volt indication on the Precision DC Voltmeter.

- k. INTERACTION—If R27 was adjusted, repeat step 15.

- l. Disconnect the voltmeter.

- m. Set the 7A13 controls as follows:

(V_C) Polarity	Pushbuttons canceled
VOLTS Display	0.000
– INPUT Mode	GND

- n. Disconnect the resistor and binding post adapter.

HIGH-FREQUENCY COMPENSATION ADJUSTMENTS

Equipment Required

- | | |
|--|---|
| <ol style="list-style-type: none"> 1. Indicator oscilloscope. 2. Time-Base unit. 3. Plug-in extender. 4. Pulse Generator. 5. Square-Wave Generator. 6. 60 ns charge cable. | <ol style="list-style-type: none"> 7. 5 ns, 50 ohm coaxial cable. 8. 3.45 ns charge cable. 9. 10X attenuator. 10. 50 ohm termination. 11. Polarized viewer or viewing hood. 12. Screwdriver. 13. Alignment tool. |
|--|---|

When performing a complete procedure, change the following settings and proceed with step 17.

7A13

+ INPUT Mode	DC
- INPUT Mode	GND
VOLTS/DIV	10 mV
BW	FULL

Time Base Plug-In

Time/Div	.05 μ s
----------	-------------

If the remaining controls need to be checked for proper settings or if step 17 is being used as a starting point for partially calibrating the 7A13, refer to the Preliminary Procedure.

17. Check/Adjust High-Frequency Compensation (both inputs)

a. Turn off the indicator oscilloscope. Remove the Plug-in Extender and insert the 7A13 directly into the indicator oscilloscope Left Vert plug-in compartment. Turn on the indicator oscilloscope.

b. Set the Type 109 Pulse Generator controls as follows:

Amplitude	9
Voltage Range	5.0
Pulse Polarity	+
Power	On

c. Connect a 3.45 ns charge line to the Type 109 50 Ω Chg Line 1 connector. Connect a 5 ns coaxial cable from the Type 109 50 Ω Chg Line 2 connector to the Type 113 Delay Cable.

d. From the Type 109 50 Ω Output connector, connect the signal through a 10X attenuator, 5-ns coaxial cable and a 50-ohm termination to the 7A13 + INPUT connector. Remove the CRT light filter and mount a polarized viewer or a viewing hood on the indicator oscilloscope bezel.

e. Use the indicator oscilloscope CRT controls, the 7A13 POSITION control, and the Type 109 Amplitude control to obtain a display 8 divisions in amplitude as shown in Fig. 5-8A.

NOTE

Use these controls as desired to display the waveform for best viewing when performing step 17.

f. Depress the time base unit X10 Magnifier pushbutton and use the Position control to position the waveform to the location shown in Fig. 5-8B.

g. CHECK—System risetime and aberrations (+ INPUT): Narrow pulse amplitude should be 80% or more of the wide pulse amplitude. This is equal to 6.4 divisions peak to peak (see Fig. 5-8B) or more when the wide pulse is 8 divisions in amplitude as shown in Fig. 5-8A. This is also equivalent to a system risetime of 3.5 ns as measured between the 10% and 90% points on the rising portion of the wide pulse (see Fig. 5-8B) based on an 8-division pulse amplitude (see Fig. 5-8A).

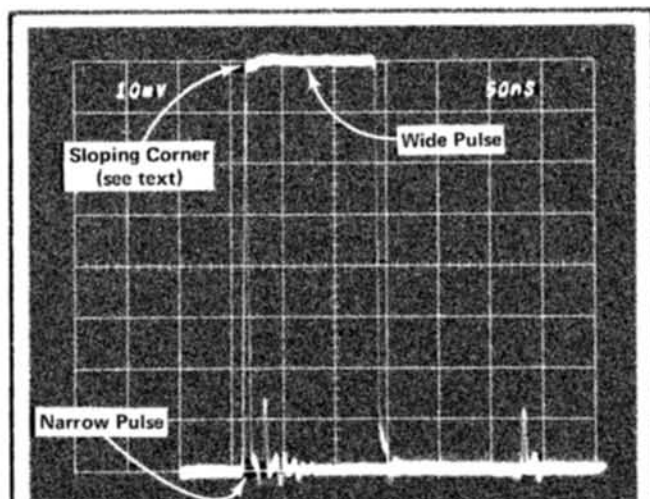
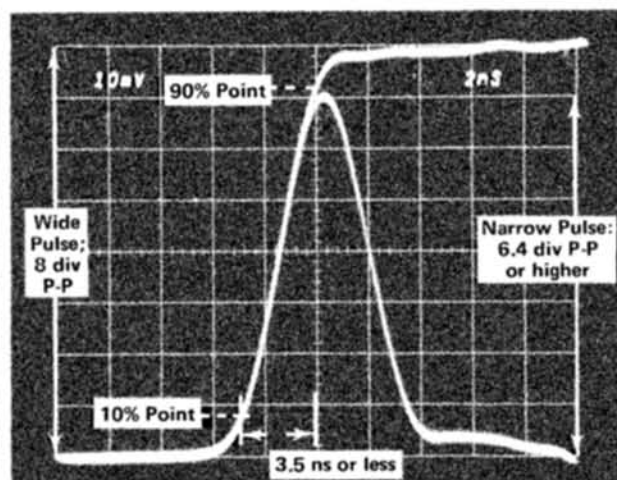
(A) Dual pulse waveform displayed at a sweep rate of .05 $\mu\text{s}/\text{div}$.

(B) Checking risetime using the narrow pulse technique or the 10%-to-90% method. Sweep rate is 2 ns/div.

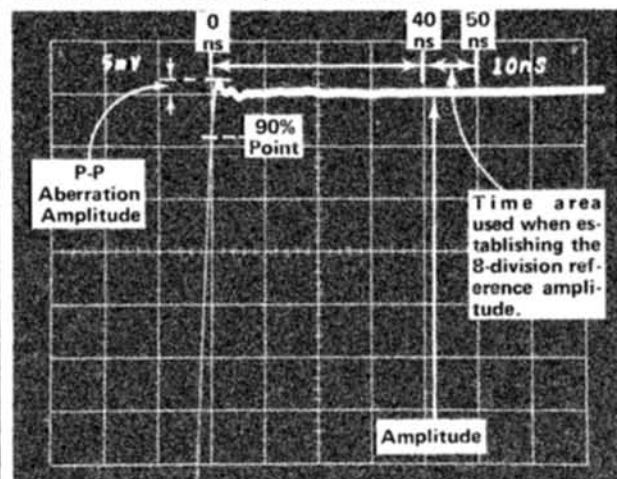

(C) Checking peak-to-peak aberration amplitude. Sweep rate is 10 ns/div. The 8-division reference amplitude was established when the top of the waveform was positioned to the top of the graticule. Then the waveform was positioned downward one division as a vertical position reference location for checking aberrations.

Fig. 5-8. Waveform examples showing correct high-frequency response derived from a square wave generator; Type 109 for (A) and (B); Type 106 for (C).

Using Table 5-2 and the procedure that follows as a guide, check the system risetime and aberrations for all the VOLTS/DIV switch settings given in the table.

TABLE 5-2
Check Step Response Risetime
& Aberrations (both inputs)

Generator	VOLTS/DIV Switch Setting	Use 10X Atten.	Use 50 Ω Term.	CHECK		
				System Rise-time ³	System Aberrations ⁴	
Type 109 Pulse Generator	10 mV	X	X	X	No Check	
	5 mV	X	X	X		
	2 mV	X	X	X		
	1 mV	X	X	X		
	20 mV	Not Used	X	X		
	50 mV		X	X		
	.1 V		X	X		
	.2 V		X	X		
	.5 V		X	X		
	1 V		X	X		
2 V	X		X			
5 V	X		X			
Type 106 Square-Wave Generator	50 mV			X	X	X
20 mV			X	X	X	X
10 mV		X	X	No Check	X	
5 mV	X	X	X	X	X	
2 mV	X	X	X	X	X	
1 mV	X	X	X	X	X	

³To meet the system risetime requirement, the narrow pulse amplitude must be 80% of the wide pulse amplitude. With an 8-division peak-to-peak wide pulse displayed, the narrow pulse amplitude should be 6.4 divisions or more peak to peak.

⁴Amplitude of the generator output should be maintained at 8 divisions peak to peak. Then the display should be positioned downward one division when applying the signal to the + INPUT connector (as shown in Fig. 5-8C) and the Time/Div switch set to 10 ns/div to permit visual measurement of the aberrations. When the signal is applied to the - INPUT connector, the 8-division waveform should be positioned one division above the bottom of the graticule.

Calibration Procedure Only: When performing step 17g, check the 50 mV to 1 mV VOLTS/DIV switch settings for both inputs. If the instrument operates properly, check the remaining VOLTS/DIV switch settings. If the instrument needs recalibration, perform the high frequency adjustments as described in the remaining portion of this procedure. Then perform steps 18 through 20. Next, repeat step 17 to recheck the VOLTS/DIV switch settings for both inputs.

Performance Check/Calibration—7A13 (SN B200000-up)

Performance Check and Calibration Procedure: When checking aberrations, use the information given in Table 5-3 and the NOTE that follows.

NOTE

The aberration tolerance is given as a guide to check the instrument for correct operation and is not an instrument specification. The tolerance measurement excludes the thickness of the trace. Fig. 5-8C shows an example of a waveform obtained when using a Type 106 as a generator. When using the Type 109 as a generator, the tolerance measurement also excludes the sloping front corner of the waveform caused by the characteristics of the Type 113 Delay Cable used as a charge line to produce the wide pulse.

TABLE 5-3
Step Response Aberration Tolerances
(both inputs)

Signal Applied to:	VOLTS/DIV Switch Settings	Aberration Tolerance ⁵ (No greater than)
+ INPUT Connector	1 mV to 5 mV	+4%, -4%, or a total of 6% peak to peak
	10 mV to .5 V	+5%, -3.0%, or a total of 5% peak to peak
	1 V to 5 V	+10%, -10%, or a total of 15% peak to peak
- INPUT Connector	1 mV to 5 mV	+4%, -4%, or a total of 6% peak to peak
	10 mV to .5 V	+3%, -3%, or a total of 5% peak to peak
	1 V to 5 V	+10%, -10%, or a total of 15% peak to peak

⁵This is not an instrument specification; see the NOTE in step 17g. When checking the aberrations, use a 10 ns/div sweep rate and measure the total peak-to-peak aberration in the form of overshoot, rounding, ringing, or tilt expressed as a percentage of pulse amplitude. Exclude the thickness of the trace in the measurement. (When using the Type 109 with a Type 113 as a generator, also exclude the front corner slope from the measurement). The pulse amplitude reference level is the average level in the 40 ns to 50 ns period after the 90% point of the step see Fig. 5-8C).

When the checks using the Type 109 Pulse Generator as the signal source are completed, turn off the generator and disconnect it from the 7A13. To complete the checks listed in Tables 5-2 and 5-3 using the Type 106 Square-Wave Generator as the signal source, set the controls as follows:

Type 106	
Repetition Rate	100 kHz
Range	
Multiplier	1
Symmetry	As is
Amplitude	Not applicable
Hi Amplitude/Fast Rise	Fast Rise
+ Transition Amplitude	Fully CCW
- Transition Amplitude	Not applicable
Power	On

7A13	
VOLTS/DIV	50 mV

Time Base Plug-In	
Magnifier	X1
Time/Div	5 μ s

Apply the signal from the Type 106 + Output connector through a 5 ns coaxial cable and 50-ohm termination to the 7A13 + INPUT connector. Set the Type 106 + Transition Amplitude and Symmetry controls for a symmetrical waveform 8 divisions peak-to-peak in amplitude. Set the time-base unit Magnifier switch to X10 and the Time/Div switch to 0.1. Recheck the amplitude of the step waveform and reset the generator + Transition Amplitude control as necessary, to obtain 8 divisions of vertical deflection in the 40 ns to 50 ns region as described earlier (step 17g). Check aberrations for the 50 mV to 1 mV positions of the 7A13 VOLTS/DIV switch.

Performance Check/Calibration—7A13 (SN B200000-up)

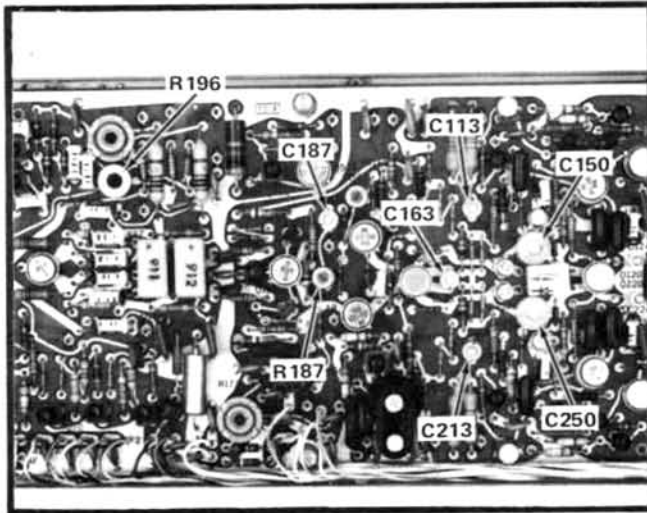

Fig. 5-9. Location of high-frequency adjustments on the Input board.

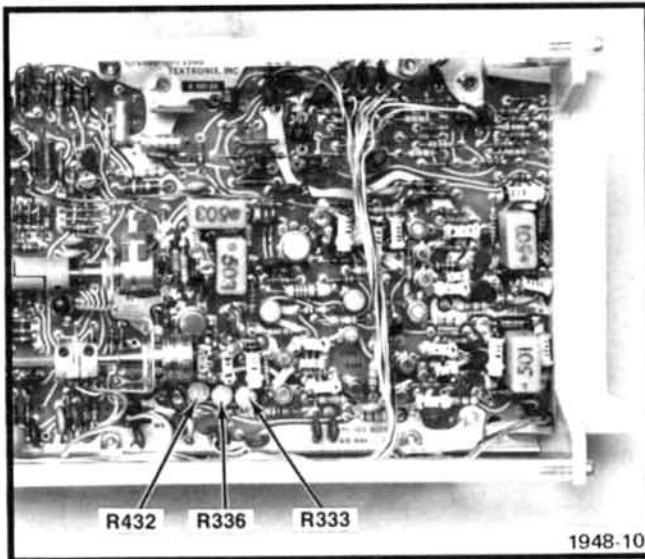

Fig. 5-10. Partial view of the Output board showing location of the high-frequency adjustments.

h. After checking the system step response and aberrations with the signal applied to the + INPUT connector, disconnect the signal from the + INPUT connector and apply it to the - INPUT connector.

i. Set the controls as follows:

7A13	
+ INPUT Mode	GND
- INPUT Mode	DC

Time Base Unit

Level/Slope (Triggering)	Negative slope region
-----------------------------	-----------------------

j. CHECK—System risetime and aberrations (- INPUT): Use step 17h with Tables 5-2 and 5-3 as guide to check the system step response. The waveforms will appear similar to those shown in Fig. 5-8B and 5-8C except that the waveforms will be negative-going.

k. For Performance Check Only, go to step 18.

l. ADJUST—R196, R432, R333, R336, C187, R187, C163, C113, C150, C250 and C213 (see Figs. 5-9 and 5-10) in the given order for optimum response to a square wave. C250 and C213 are mainly - INPUT adjustments. To perform the adjustments, use the information in the procedure that follows.

m. After performing steps 17a through 17j and it is determined that the 7A13 high-frequency square-wave response needs to be improved, a suggested sequence is outlined in Table 5-4. The steps that follow provide additional information based on this sequence. Read the procedure and study the table to determine, if possible, the adjustments that need to be made to restore the 7A13 to its required performance.

Performance Check/Calibration—7A13 (SN B200000-up)

n. Turn off the indicator oscilloscope. Insert the Plug-In Extender between the 7A13 and the indicator oscilloscope. Turn on the indicator oscilloscope.

o. Set the controls as follows:

7A13

+ INPUT Mode	DC
-- INPUT Mode	GND
VOLTS/DIV	10 mV
BW	5 MHz

Time Base Plug-In

Level/Slope (Triggering)	Positive slope region
Magnifier	X1
Time/Div	.1 ms

Type 106

Repetition Rate	10 kHz
Range	

p. Remove the 10X attenuator and connect the 5 ns coaxial cable directly to the Type 106 + OUTPUT connector. Disconnect the Type 106 signal from the 7A13 - INPUT connector and apply it to the + INPUT connector.

q. Using Table 5-4 and Fig. 5-11 as a guide, perform the high-frequency compensation adjustments. Note that when using the table, the Plug-In Extender is used while adjusting R196, R432, R336, and R333. For all the remaining adjustments, the Plug-In Extender is removed and the 7A13 is inserted directly into the indicator oscilloscope. Use a 6-division peak-to-peak waveform amplitude during the adjustment procedure. Keep the waveform positioned about one division below the top of the graticule when using the + INPUT connector and about one division above the bottom of the graticule when using the - INPUT connector.

r. After completing the high-frequency compensation adjustments and checking that the instrument operates properly for all VOLTS/DIV switch settings from 50 mV to 1 mV, perform steps 18 through 20. Then, repeat step 17 to recheck all the VOLTS/DIV switch settings.

s. Disconnect the signal from the 7A13 and leave the generator turned on.

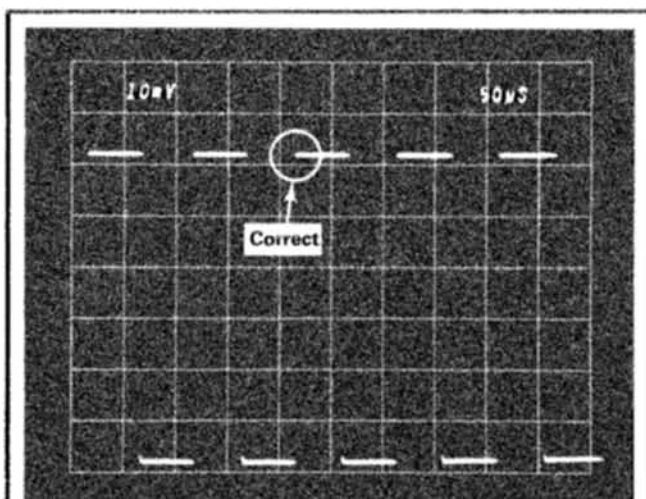

(A) Waveform example showing correct high-frequency response to a 10-kHz square wave at a sweep rate of 50 μ s/div.

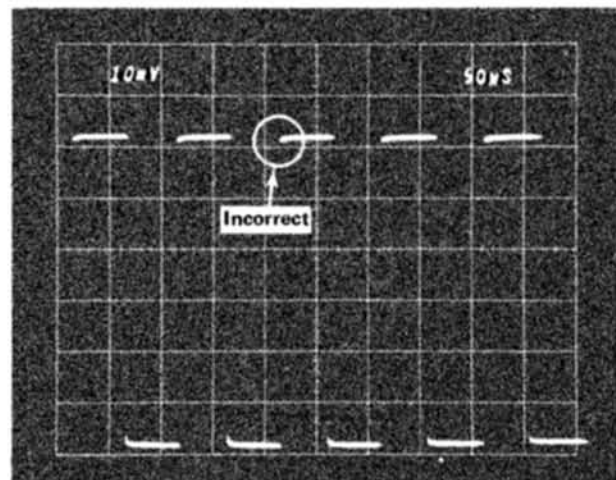

(B) R196 is misadjusted to show its effect on the 10-kHz waveform. Sweep rate is 50 μ s/div.

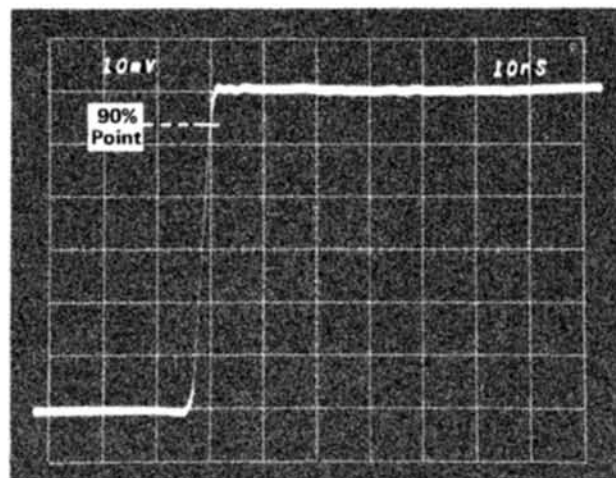

(C) Waveform example showing correct high-frequency response to a 100-kHz square wave at a sweep rate of 10 ns/div.

Fig. 5-11. Waveform examples obtained when performing the high-frequency adjustment procedure.

TABLE 5-4
High-Frequency Compensation Adjustment Sequence

Type 106 Repetition Rate	Signal Applied to:	Time Base Sweep Rate	Adjustment	Approximate Time Domain ⁶	Procedure
10 kHz	+ INPUT Connector	.1 ms/div	R196 ⁷	50 μ s	Turn off the oscilloscope. Insert the Plug-In Extender between the 7A13 and indicator oscilloscope. Turn on the indicator oscilloscope. Set the VOLTS/DIV switch to 10 mV and the BW switch to 5 MHz. Adjust for best flat top. Reset BW switch to FULL for remaining adjustments.
100 kHz		.5 μ s/div	R432	100 ns	Adjust for optimum square corner. (Ignore fast spike, if any, that may remain on the top front corner.)
		.5 μ s/div or 1 μ s/div	R336 R432	50 ns	Adjust for optimum square corner.
		50 ns/div	R333		
		5 ns/div or 10 ns/div	C187	5 ns to 10 ns	Turn off indicator oscilloscope. Remove the Plug-In Extender and insert the 7A13 directly into the indicator oscilloscope. Replace Type 106 with Type 109 as a signal source. Turn on indicator oscilloscope. Adjust for optimum square corner. Leave the 7A13 inserted directly in the indicator oscilloscope for the remaining adjustments. Adjust for minimum ripple near front corner. Adjust for optimum square corner. Adjust in equal increments to maintain C150 and C250 at or nearly the same physical positions.
		R187	2 ns to 7 ns		
		C163	2 ns		
		C113	2 ns to 4 ns		
		C150	1 ns to 3 ns		
			C250	1 ns to 3 ns	
		- INPUT Connector	10 ns/div	C213 C250	2 ns to 6 ns 1 ns to 5 ns
	+ INPUT Connector	5 ns/div	C150 C113 C163	same as given previously	Repeat applicable portions of step 17o. Readjust for optimum square corner.
	- INPUT Connector	5 ns/div	C213 C250	Same as given previously	Repeat steps 17h and 17i. Readjust for optimum square corner.
	+ INPUT Connector	5 ns/div	C163 C113 C150	Same as given previously	Repeat applicable portions of step 17o. Readjust for optimum square corner. Set 7A13 for 1 mV and readjust for optimum square corner. Repeat steps 17g through 17j. If a bump is present in the 5 ns to 10 ns region, perform step 20.
			C187	Same as given previously	After performing step 20, C187 may need to be readjusted. Repeat steps 17g through 17j.

⁶The 90% point on the rising portion of the waveform (see Fig. 5-11C for location) is the time reference used to determine the time domain or area affected by the adjustment. For example, with the sweep rate set at 5 ns/div, adjustment of C187 will affect the 5 ns to 10 ns area near the top front corner of the waveform when measured with respect to the 90% point on the rising portion of the waveform.

⁷If R196 is adjusted, repeat step 3.

ATTENUATOR COMPENSATION ADJUSTMENTS

Equipment Required

- | | |
|---|--|
| <ol style="list-style-type: none"> 1. Indicator oscilloscope. 2. Time-Base unit. 3. Square-Wave Generator. 4. 5 ns, 50 ohm coaxial cable. | <ol style="list-style-type: none"> 5. 10X attenuator. 6. GR to BNC adapter. 7. 20 pF Input RC Normalizer. 8. 50 ohm termination. 9. Alignment tool. |
|---|--|

When performing a complete procedure, change the following control settings and proceed with step 18.

7A13	
+ INPUT Mode	DC
- INPUT Mode	GND
VOLTS/DIV	10 mV
BW	5 MHz

Time-Base Plug-In

Level/Slope (Triggering)	Positive slope region
Time/Div	0.5 ms
Magnifier	X1

If the remaining controls need to be checked for proper settings or if step 18 is being used as a starting point for partially calibrating the 7A13, refer to the Preliminary Procedure.

18. Check/Adjust + INPUT Attenuator Compensation

a. Set the Type 106 Square-Wave Generator controls to the following positions:

Repetition Rate	1 kHz
Range	
Multiplier	1
Symmetry	Midrange
Amplitude	Fully CCW
Hi Amplitude/Fast Rise	Hi Amplitude
Fast Rise controls	Not applicable

b. Apply the 1 kHz signal from the Type 106 high amplitude Output connector through a 10X attenuator, 5-ns coaxial cable, 50-ohm in-line termination and a 20-pF input RC normalizer to the 7A13 + INPUT connector.

c. Set the Type 106 Amplitude control to produce a display 6 divisions in amplitude. Use the 7A13 POSITION control to center the display.

d. Set the Type 106 Symmetry control for a symmetrical waveshape and, if necessary, reset the Multiplier control to obtain the 1 kHz output repetition rate.

e. CHECK—The waveform should have a flat top similar to the illustration shown in Fig. 5-12A. Aberrations should not exceed $\pm 1\%$ or ± 0.06 division for a 6-division peak-to-peak display.

Using Table 5-5 as a guide, check the waveform for a flat top and square front top corner in the 10 mV to 5 V positions of the VOLTS/DIV switch. Use a 6 division display amplitude for each switch position.

NOTE

The aberration tolerance described in this step is given as a guide to correct instrument operation and is not an instrument specification.

f. ADJUST—The + INPUT shunt capacitance and the attenuator adjustments listed in Table 5-5 for optimum square corner and flat top (see Fig. 5-12A). Readjust the generator output with each setting of the VOLTS/DIV switch to obtain 6 divisions of deflection. Remove the 10X attenuator and the 50-ohm termination when necessary to obtain more signal drive. In the 2 V/DIV position, replace the 50-ohm termination with a GR-to-BNC adapter.

Fig. 5-12B through 5-12E are some waveform examples obtained when the adjustments were misadjusted. Fig. 5-13 shows the location of the adjustments.

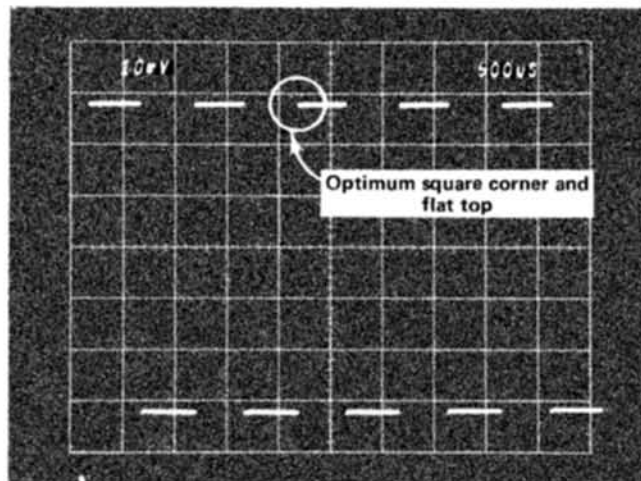

(A) Correct.

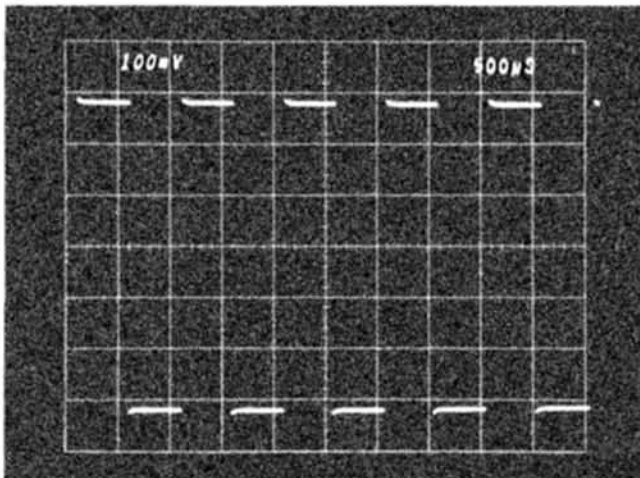

(B) Input shunt capacitance adjustment incorrect.

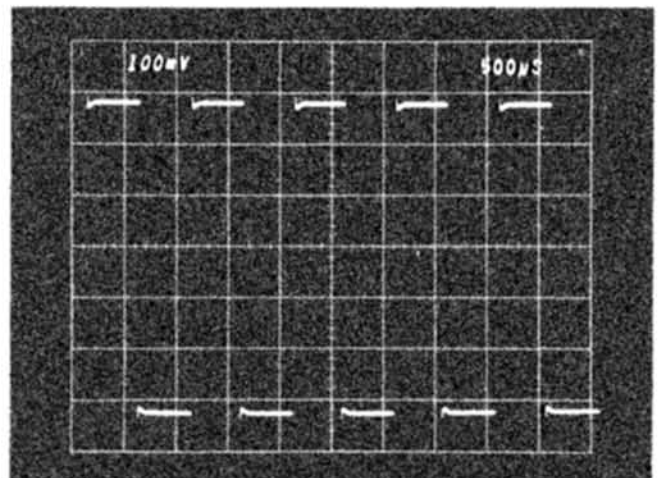

(D) Input attenuator adjustments incorrect.

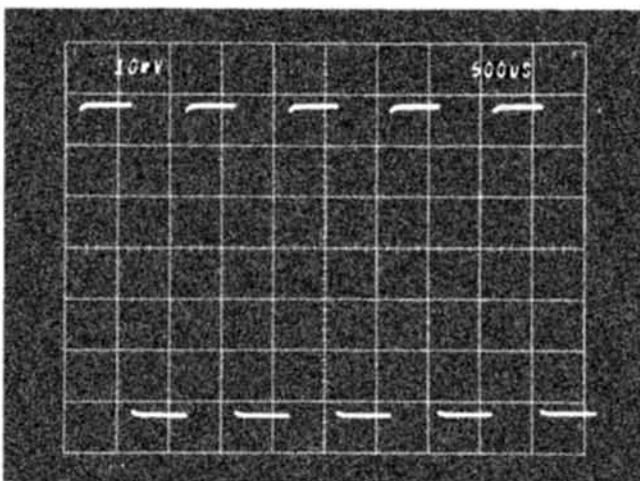

(C) Input shunt capacitance adjustment incorrect.

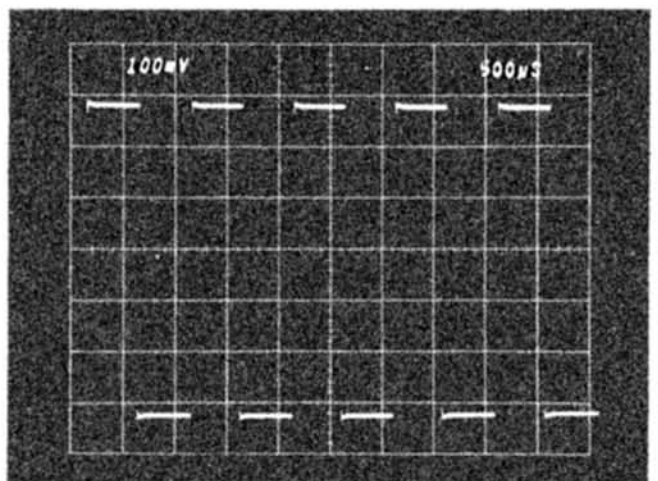

(E) Input attenuator adjustments incorrect.

Fig. 5-12. Examples of waveforms obtained when performing step 18. Sweep rate is 0.5 ms/div.

TABLE 5-5
+ INPUT Attenuator Adjustments

VOLTS/DIV Switch Setting	Use 10X Atten.	Use 50 Ω Term.	Use GR-to-BNC Adapter	Use RC Norm.	Adjust for Optimum		
					Top Front Corner Squareness	Flat Top	
10 mV	X	X	Not Used	X	No Adjustment	C14	
20 mV	X	X		X		Check	
50 mV	X	X		X		Check	
.1 V	Not Used	X	Not Used	X	C8A	C8B	
.2 V		X		X	Check	Check	
.5 V		X		X	Check	Check	
1 V		X		X	C5A	C5B	
2 V		Not Used		X	X	Check	Check
5 V		Not Used		X	X	Check	Check

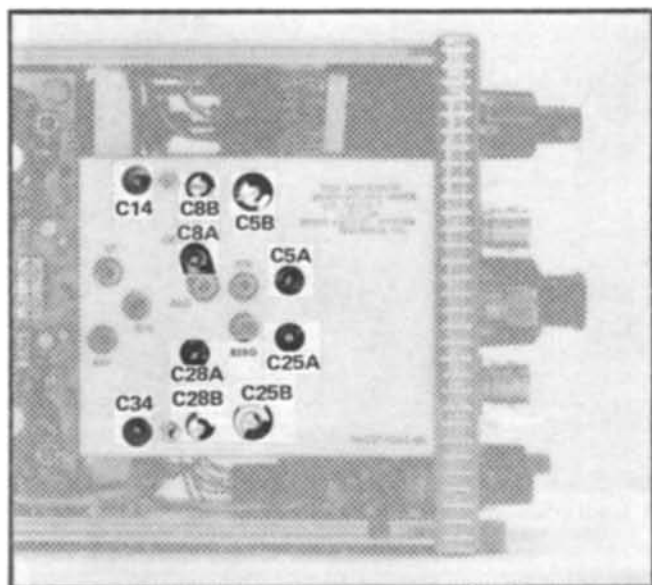

Fig. 5-13. Adjustment locations used in the Attenuator Compensation Adjustment procedure.

19. Check/Adjust — INPUT Attenuator Compensation

a. Set the Type 106 Amplitude control for minimum output.

If the waveform aberrations exceed the $\pm 1\%$ tolerance requirement when performing the "Check" portion of the table, it may be necessary to compromise the adjustment(s) that precede the Check. For example, to minimize the top front corner aberration in the .5 V position, slightly readjust C8A; then recheck the .2 V and .1 V switch positions to determine if the tolerance is within the specified requirement.

When adjusting C8A and C5A, the time-base can be set for a sweep rate of 0.2 ms/div.

b. Disconnect the 20-pF input RC normalizer from the + INPUT connector and connect it to the - INPUT connector.

c. Insert the 50-ohm termination in place of the GR-to-BNC adapter. Reconnect the 10X attenuator between the coaxial cable and Type 106 Output connector.

d. Set the 7A13 controls as follows:

+ INPUT Mode	GND
- INPUT Mode	DC
VOLTS/DIV	10 mV

e. Check that the time base plug-in unit Time/Div switch is set to .5 ms.

f. Set the Type 106 Amplitude control to obtain a display 6 divisions in amplitude.

g. Set the time base plug-in unit Level/Slope control in the negative slope region.

h. CHECK—The waveform should have a flat bottom as illustrated in Fig. 5-14. Aberrations should not exceed $\pm 1\%$ or ± 0.06 division for a 6 division peak-to-peak display.

Using Table 5-6 as a guide, check the waveform for a flat bottom and square front bottom corner in the 10 mV to 5 V positions of the VOLTS/DIV switch. Use a 6 division display amplitude for each switch position.

TABLE 5-6
— INPUT Attenuator Adjustments

VOLTS/DIV Switch Setting	Use 10X Atten.	Use 50 Ω Term.	Use GR-to-BNC Adapter	Use RC Norm.	Adjust for Optimum	
					Bottom Front Corner Squareness	Flat Bottom
10 mV	X	X	Not Used	X	No adjustment	C34
20 mV	X	X		X		Check
50 mV	X	X		X		Check
.1 V	Not Used	X		X	C28A	C28B
.2 V		X		X	Check	Check
.5 V		X		X	Check	Check
1 V		X		X	C25A	C25B
2 V		Not Used	Not Used	X	Check	Check
5 V		Not Used	Not Used	X	Check	Check

NOTE

The aberration tolerance described in this step is given as a guide to correct instrument operation and is not an instrument specification.

i. ADJUST—The — INPUT shunt capacitance C34 and the attenuator adjustments listed in Table 5-6 for a square lower front corner and flat bottom (see Fig. 5-14). The procedure used here is similar to the procedure used in performing step 18. Fig. 5-13 shows the locations of the adjustments.

j. Disconnect the signal from the — INPUT connector and turn off the generator.

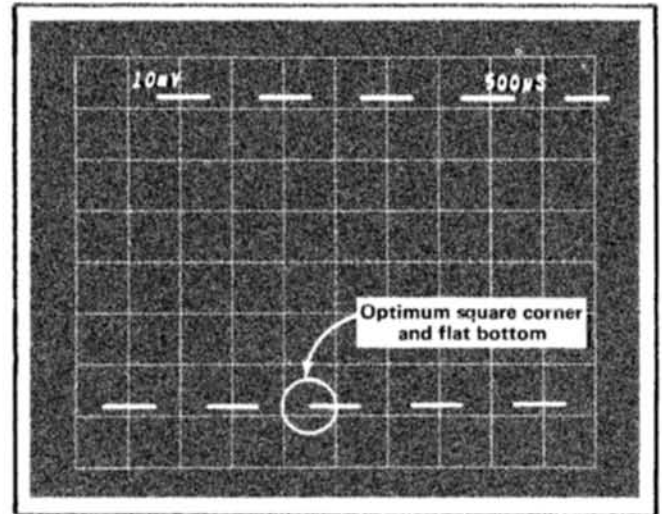

Fig. 5-14. Checking for optimum — INPUT waveform at sweep rate of 0.5 ms/div.

COMMON MODE REJECTION ADJUSTMENTS

Equipment Required

1. Indicator oscilloscope.
2. Time-Base unit.
3. Square-Wave Generator.
4. Medium-Frequency Sine-Wave Generator.
5. Low-Frequency Sine-Wave Generator.
6. 42 inch, 50 ohm coaxial cable.
7. 5 ns, 50 ohm coaxial cable.
8. GR to BNC adapter.
9. Flexible T connector.
10. Screwdriver.
11. Alignment tool.

When performing a complete procedure, change the following control settings and proceed with step 20.

	7A13
+ INPUT Mode	DC
- INPUT Mode	GND
VOLTS/DIV	2 V
BW	FULL

Time Base Plug-In

Level/Slope (Triggering)	Positive slope region
Time/Div	.5 μ s

If the remaining controls need to be checked for proper settings or if step 20 is being used as a starting point for partially calibrating the 7A13, refer to the Preliminary Procedure.

20. Check/Adjust Amplifier High-Frequency Common Mode Rejection

a. Set the Medium-Frequency Sine-Wave Generator (Type 191) controls as follows:

Frequency dial	1 MHz
Frequency Range	.75—1.6
Amplitude	50
Variable	Cal
Amplitude Range	.5 to 5 V
Power	On

b. Connect the 1-MHz signal from the Type 191 Output connector through a 5 ns coaxial cable and GR-to-BNC adapter to the flexible T connector.

c. Use the positioning controls to position the display for best viewing.

d. Set the Type 191 Variable control to obtain a display 5 divisions peak to peak in amplitude. This indicates that a 10-volt signal is applied to the 7A13.

e. Set the controls as follows:

7A13

- INPUT Mode	DC
VOLTS/DIV	1 mV

Time Base Plug-In

Time/Div	.5 μ s
----------	------------

f. CHECK—One division or less display amplitude. This is equivalent to a CMRR of 10,000:1 or greater. Measure the peak to peak excursion, excluding the trace thickness, as shown in Fig. 5-15.

g. ADJUST—C124 and C224 (see Fig. 5-16) to reduce the display amplitude.

h. CHECK—Using Table 5-7 as a guide, check the peak-to-peak display amplitude at the given frequencies.

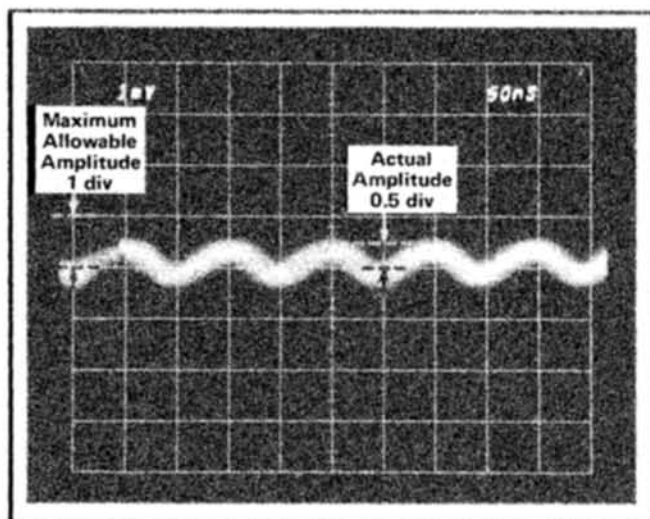

Fig. 5-15. Measuring the peak-to-peak amplitude of a common mode difference signal. Vertical deflection factor: 1 mV/div; sweep rate, 0.5 μ s/div.

TABLE 5-7
Common Mode Rejection Checks

Generator	Generator		VOLTS/DIV	Time/Div	Amplitude	CMRR
	Frequency	Amplitude				
Type 191	10 MHz	1 V	2 mV	.05 μ s	2 div or less	500:1
	20 MHz	1 V	5 mV	.05 μ s	4 div or less	200:1
Low-Freq. Sine-Wave Generator	100 kHz	20 V	1 mV	5 μ s	1 div or less	20,000:1

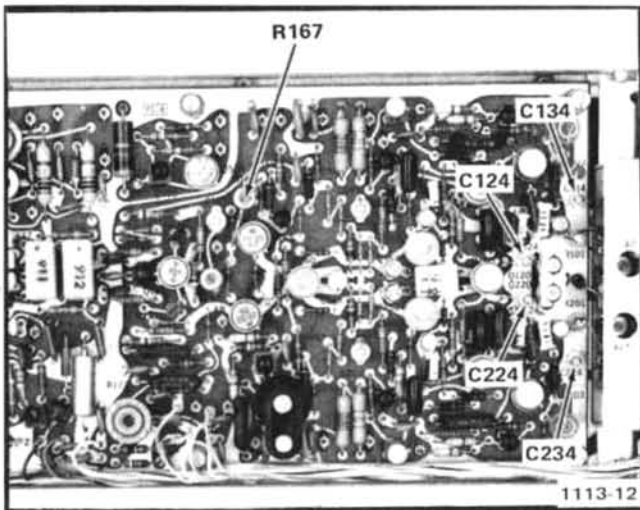

Fig. 5-16. Location of adjustments on the Input board for the Common Mode Rejection Adjustments procedure.

NOTE

Because the output of the Type 191 is unterminated, the output amplitude is approximately two times the amplitude indicated by the front panel controls. Check the amplitude of the signal applied to the 7A13 before each CMRR measurement.

i. ADJUST—If peak-to-peak display amplitude exceeds the amount given in the table for any frequency, offset C134 or C234 slightly by turning the slug a turn or two; then, repeat parts a through h of this step. If the minimum amplitude thus obtained is not less than the amplitude obtained before C134 or C234 were offset, turn C134 or C234 slug in the opposite direction.

j. Readjust R167 slightly for minimum amplitude. Repeat parts a through h of this step.

k. INTERACTION—The procedure and all adjustments given in step 20 may need to be readjusted several times to obtain the best compromise between the display amplitude obtained using the 1-MHz signal, and the one obtained using the 20-MHz signal.

l. Disconnect the signal from the flexible T connector.

m. INTERACTION—Repeat step 17 and then step 20 as often as necessary to meet the performance requirements.

21. Check/Adjust Attenuator Common Mode Rejection at 100 Hz

a. Set the controls as follows:

	7A13
+ INPUT Mode	GND
– INPUT Mode	GND
VOLTS/DIV	2 V
(V _c) Polarity	–
VOLTS Display	050.0
BW	5 MHz

Time Base Plug-In

Time/Div 5 ms

Type 106

Repetition Rate	100 Hz
Range	
Multiplier	1
Symmetry	Midrange
Amplitude	CCW
Hi Amplitude/Fast Rise	Hi Amplitude
Fast Rise controls	Not applicable
Power	On

b. Apply the 100-Hz signal from the Type 106 Output connector through a 5 ns coaxial cable and a GR-to-BNC adapter to the flexible T connector attached to the 7A13.

c. Using the 7A13 POSITION control, position the trace to graticule center.

d. Simultaneously set the + INPUT Mode switch to DC and the – INPUT Mode switch to V_c.

Performance Check/Calibration—7A13 (SN B200000-up)

e. Set the Type 106 Amplitude control to position the bottom of the square waves to coincide with the graticule center. At this point in the procedure, the Type 106 generator is set for a -50 volts to 0 volt peak amplitude square-wave output signal.

NOTE

To check that the signal is set to the proper amplitude, press the V_C REF-IDENT button and check that the trace is positioned to graticule center. Release the V_C REF-IDENT button. Readjust, if necessary, the generator Amplitude control to position the bottom of the square waves to coincide with graticule center.

f. Set the controls as follows:

7A13

- INPUT Mode DC
VOLTS/DIV .1 V

Time Base Plug-In

Time/Div 2 ms

g. CHECK—For a 0.25 division (25 mV) or less display amplitude when comparing the flat top and bottom portions of the common mode difference signal. This is equivalent to a CMRR of 2,000:1 or greater. Ignore the spikes on the leading portions of the square wave.

h. ADJUST—R28B (see Fig. 5-7) for minimum square wave display amplitude when comparing the flat portions of the signal.

i. Set the VOLTS/DIV switch to 1 V.

j. CHECK—For 1/8 of a minor division (25 mV) or less display amplitude when comparing the flat top and bottom portions of the square wave. This is equivalent to a CMRR of 2,000:1 or greater.

NOTE

One-eighth minor division (about 1/2 trace width) is difficult to measure. However, measure the amplitude as closely as possible to determine whether or not the requirement is met.

Calibration Procedure Only: If there is some doubt, slight adjustment of R5E (part k of this step) reduces the amplitude to a straight line so that the 7A13 will have a CMRR of 2,000:1 or greater.

k. ADJUST—R5E (see Fig. 5-7) for minimum square wave display amplitude when comparing the flat portions of the signal.

l. Disconnect the signal from the flexible T connector and turn off the generator.

22. Check/Adjust Attenuator Common Mode Rejection at 10 kHz

a. Set the controls as follows:

7A13

+ INPUT Mode GND
- INPUT Mode GND
VOLTS/DIV 2 V
VOLTS Display 025.0

Time Base Plug-In

Time/Div .5 ms

Low-Frequency Sine-Wave Generator

Frequency switch 2 kHz-20 kHz
Frequency dial 10
Level control As is

b. Apply the 10 kHz signal from the low frequency sine-wave generator Output connector through a 42-inch 50-ohm coaxial cable to the flexible T connector attached to the 7A13.

c. Using the 7A13 POSITION control, position the trace to graticule center.

d. Simultaneously set the + INPUT Mode switch to DC and the - INPUT Mode switch to V_C .

e. Set the generator Level control so that the bottom tips of the sine waves coincide with graticule center. At this point in the procedure, the generator is set for a 50-volt peak-to-peak output signal.

NOTE

To check that the signal is set to the proper amplitude, press the V_C REF-IDENT button and check that the trace is positioned to graticule center.

Release the V_C REF-IDENT button. Readjust, if necessary, the generator Level control to position the sine wave tips to coincide with graticule center.

Performance Check/Calibration—7A13 (SN B200000-up)

f. Set the controls as follows:

7A13

– INPUT Mode DC
VOLTS/DIV .1 V

Time Base Plug-In

Time/Div .2 ms

g. CHECK—For 0.25 division (25 mV) or less display amplitude. This is equivalent to a CMRR of 2,000:1 or greater.

h. ADJUST—C28A (see Fig. 5-7) slightly for minimum display amplitude.

i. Set the VOLTS/DIV switch to 1 V.

j. CHECK—For 1/8 of a minor division (25 mV) or less display amplitude. This is equivalent to a CMRR of 2,000:1 or greater.

NOTE

Measure the amplitude as closely as possible. Exclude the thickness of the trace when making the measurement. Calibration Procedure Only: If there is doubt whether or not the display amplitude meets the requirement, slight adjustment of C25A (part k of this step) causes a noticeable effect on the display and it is easy to observe when the minimum amplitude point is reached.

k. ADJUST—C25A (see Fig. 5-7) slightly for minimum display amplitude.

l. Disconnect the signal and turn off the generator. Remove the flexible T connector from the 7A13.

TRIGGER AND SIGNAL AMPLIFIER RESPONSE CHECKS (including a trigger gain check)

Equipment Required

- | | |
|--|--|
| <ol style="list-style-type: none"> 1. Indicator oscilloscope. 2. Time-Base unit. 3. Plug-in extender. 4. Pulse Generator. 5. Square-Wave Generator. | <ol style="list-style-type: none"> 6. Sine-Wave Generator (Med. Freq.). 7. 5 ns, 50 ohm coaxial cable. (2) 8. 3.45 ns charge cable. 9. 10X attenuator. 10. 50 ohm termination. 11. Polarized Viewer or Viewing hood. |
|--|--|

When performing a complete procedure, change the following control settings and proceed with step 23.

	7A13
- INPUT Mode	GND
VOLTS/DIV	10 mV
VOLTS Display	0.000
(V _c) Polarity	Pushbuttons canceled
BW	FULL

Time Base Plug-In

Time/Div	.05 μ s
----------	-------------

If the remaining controls need to be checked for proper settings or if step 23 is being used as starting point for partially calibrating the 7A13, refer to the Preliminary Procedure except as follows:

	7A13
+ INPUT Mode	DC

23. Check Trigger Amplifier Gain and Step Response

a. Insert the Plug-In Extender between the 7A13 and the indicator oscilloscope Left Vert plug-in connector.

b. Repeat steps 17b through 17h except that the generator should be set to obtain a 6-division peak-to-peak display amplitude.

c. Note the amplitude of the narrow pulse or check the risetime by measuring the time interval between the 10% and 90% amplitude points on the rising portion of the wide pulse waveform.

d. Partially remove the Plug-In Extender (with 7A13 attached). Interchange the signal and trigger coaxial cables on the Plug-In Extender. Fig. 5-17 shows the locations of the coaxial cables on the right side of the Plug-In Extender. The cables on the left side of the extender are in similar locations. (After interchanging the cables, the signal from pins A11 and B11 on the 7A13 Output board connector will be applied via the coaxial cables to the trigger connectors on each side of the Plug-In Extender. The trigger from pins A13 and B13 on the Output board will not be applied via the coaxial cables to the signal connectors on each side of the Plug-In Extender.)

e. Re-insert the Plug-In Extender (with 7A13 attached) into the indicator oscilloscope.

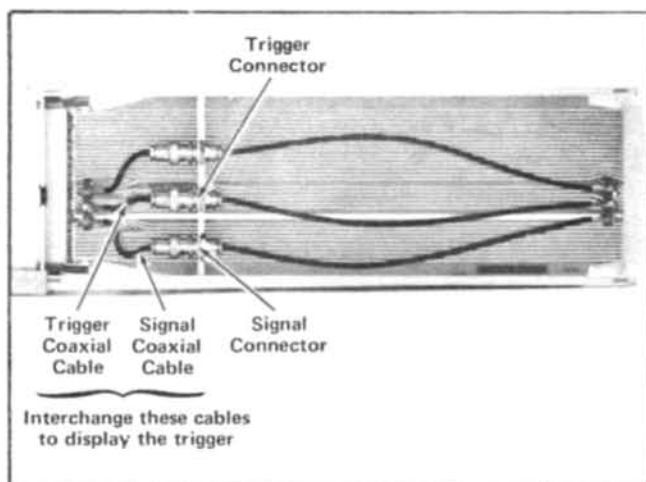

Fig. 5-17. Right side view of the Plug-In-Extender showing the location of the signal and trigger connectors with their associated coaxial cables. Left side view (not shown) is the same.

f. **Calibration Procedure Only:** Check the trigger amplitude to signal amplitude gain matching by measuring the amplitude of the wide pulse trigger waveform. The amplitude of the wide pulse should be within 15% (± 0.9 division) of the 6-division signal amplitude used as a reference in step 23c.

NOTE

This 15% gain matching tolerance is given as a guide to check the instrument for correct operation and is not an instrument specification. There are other ways to check trigger gain if it is desired to perform this check out of sequence using another signal source. For example, use the indicator oscilloscope 4 mV calibrator as a reference signal and perform the check after step 8.

g. Set the generator output amplitude to obtain a 6-division peak-to-peak wide pulse display amplitude.

h. CHECK—System risetime using the trigger. The measurement is performed as follows: Using a wide pulse amplitude of 6 divisions as a reference, the narrow pulse amplitude should be 0.4 division (or less) lower in amplitude than the amplitude of the pulse noted in step 23c. For example, if step 23c pulse amplitude is 4.9 divisions, the trigger pulse amplitude should be 4.5 divisions or more in amplitude. The risetime of the wide pulse, measured from the 10% to the 90% points, should be about 0.1 ns slower (or less) for the trigger waveform as compared to the signal waveform. For example, if the signal waveform had a risetime of 3.5 ns, the risetime of the trigger waveform should be 3.6 ns or less.

NOTE

The risetime measurements are given as a guide to check the instrument for correct operation and is not an instrument specification.

i. Return the signal and trigger coaxial cables on the Plug-In Extender to their original connections.

j. Set the Type 106 controls to the settings given in step 17g and use step 17g as a guide for applying the signal to the 7A13. Leave the VOLTS/DIV switch at 10 mV.

k. Check that the display is 6 divisions peak to peak in amplitude in the 40 ns to 50 ns region when using a sweep rate of 10 ns/div.

l. Position the display 2 divisions below the top of the graticule and measure the total peak-to-peak aberration in

the form of overshoot, rounding, ringing, or tilt, expressed as a percentage of square-wave amplitude. Exclude the thickness of the trace in the measurement. Use this information as a guide to check the trigger aberrations in the procedure that follows.

m. Interchange the signal and trigger coaxial cables on the Plug-In Extender to permit viewing the trigger.

n. Reset the generator to obtain a 6-division display amplitude.

o. CHECK—System aberration using the trigger. Measure the total peak-to-peak aberration in the form of overshoot, rounding, ringing, or tilt, expressed as a percentage of square-wave amplitude.

The trigger waveform should appear very similar to the signal waveform noted in step 23m. The peak-to-peak aberration should be no greater than +4%, -4%, or a total that does not exceed 6% peak-to-peak.

NOTE

The aberration tolerance is given as a guide to check the instrument for correct operation and is not an instrument specification.

p. Disconnect the signal and turn off the Type 106 generator.

24. Check Trigger Amplifier Sine Wave Response

a. Set the controls as follows:

Time Base Plug-In

Magnifier	X1
Time/Div	50 μ s

b. Apply a 3-MHz sine-wave signal from the generator through a 10X attenuator and 50-ohm termination to the 7A13 + INPUT connector.

Performance Check/Calibration—7A13 (SN B200000-up)

c. Adjust the generator Variable (Amplitude) control to obtain a display 8 divisions in amplitude. This is the reference amplitude (see Fig. 5-18A).

d. Set the generator Frequency Range switch to 100-250.

e. Without changing the generator output amplitude, change the output frequency until the vertical deflection of the display is reduced to 5.66 divisions (see Fig. 5-18B). This is the 30% down voltage point that is equivalent to the -3 dB point.

f. CHECK—Output frequency should be 100 MHz or higher.

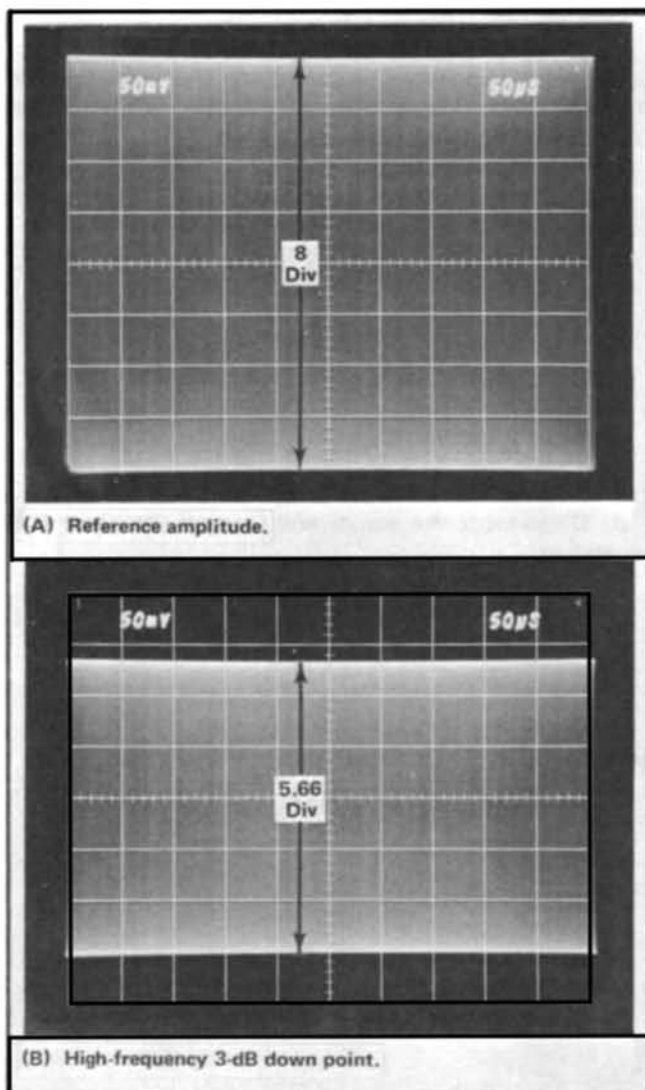

Fig. 5-18. CRT display obtained when checking high-frequency upper-limit sine-wave response. Sweep rate is 50 μ s/div.

NOTE

This upper limit bandwidth check is given as a guide to check the instrument for correct operation and is not an instrument specification.

g. Disconnect the generator signal, 10X attenuator, and 50-ohm termination from the 7A13.

h. Apply a signal from the Type 191 to the 7A13 + INPUT connector through a 5 ns coaxial cable and 50-ohm termination.

i. Set the controls as follows:

7A13	
VOLTS/DIV	10 mV
BW	5 MHz

Time Base Plug-In

Time/Div	.5 ms
----------	-------

Type 191

Frequency dial	3.6 MHz
Frequency Range	50 kHz only
Amplitude	5
Variable	Cal
Amplitude Range	50-500 mV
Power	On

j. Set the Type 191 Variable control to obtain a display 8 divisions peak to peak in amplitude. Use the positioning controls to position the display for best viewing.

k. Set the Type 191 Frequency Range switch to 3.6-8.

l. Slowly increase the Type 191 frequency until the display amplitude is 5.66 divisions.

m. CHECK—The setting of the Type 191 Frequency dial. The frequency should be between 4.5 MHz and 5.5 MHz.

n. Disconnect the signal from the 7A13.

o. Remove the Plug-In Extender and insert the 7A13 directly into the Left Vert plug-in compartment of the indicator oscilloscope.

p. Interchange the coaxial cables on the Plug-In Extender to return the cables to their respective connectors. The Plug-In Extender will not be needed for the remaining steps.

25. Check Signal Amplifier High-Frequency Sine-Wave Response

- a. Set the 7A13 BW switch to FULL.
- b. Set the Time-Base Plug-in controls as in step 24a.
- c. Apply a 3 MHz sine-wave signal from the generator through a 10X attenuator and 50 ohm termination to the 7A13 + INPUT connector.
- d. Set the generator Variable (Amplitude) control to obtain a display 8 divisions in amplitude.
- e. Set the generator Frequency Range switch to 100-250.
- f. Without changing the generator output amplitude, change the output frequency until the vertical deflection of the display is reduced to 5.66 divisions.
- g. CHECK—Output frequency should be 100 MHz or higher.
- h. Disconnect the signal and turn off the generator.

26. Check Signal Amplifier 5 MHz Bandwidth Sine-Wave Response

- a. Set the controls as follows:

	7A13
VOLTS/DIV	10 mV
BW	5 MHz

Time Base Plug-In

Time/Div .5 ms

Type 191

Frequency dial 3.6 MHz
 Frequency Range 50 kHz Only
 Amplitude 5
 Variable Cal
 Amplitude Range 50-500 mV
 Power On

- b. Apply the generator signal through a 5 ns coaxial cable and 50 ohm termination to the 7A13 + INPUT connector.
- c. Set the Type 191 Variable control to obtain a display 8 divisions peak to peak in amplitude. Use the positioning controls to position the display for best viewing.
- d. Set the Type 191 Frequency Range switch to 3.6-8.
- e. Slowly increase the Type 191 frequency until the amplitude of the display is 5.66 divisions peak-to-peak in amplitude.
- f. CHECK—The setting of the Type 191 Frequency dial. The frequency should be between 4.5 MHz and 5.5 MHz.
- g. Disconnect the signal and turn off the generator.

COMPARISON VOLTAGE ADJUSTMENTS

Equipment Required

- | | |
|--|---|
| <ol style="list-style-type: none"> 1. Indicator oscilloscope. 2. Time-Base unit. | <ol style="list-style-type: none"> 3. Precision DC Voltmeter. 4. DC Voltmeter (VOM). 5. Screwdriver. |
|--|---|

Set the 7A13 front panel controls as follows:

VOLTS Display	0.000
(V _c) Polarity	+
+ INPUT Mode	GND
- INPUT Mode	GND
VOLTS/DIV	1 mV
BW	5 MHz
COMPARISON	Fully CCW
VOLTAGE (V _c),	
COARSE	
and FINE	

Refer to Fig. 5-19 for Comparison Voltage adjustment locations.

27. Check/Adjust +V_c Zero

- a. Using the POSITION control, position the trace to coincide with the graticule center line.
- b. Change the + INPUT switch to V_c.

- c. ADJUST—The +V_c Zero control R696, to set trace 1 division below midscreen.

28. Check/Adjust -V_c Zero

- a. Change the V_c Polarity switch to -.
- b. ADJUST—The -V_c Zero control R720, to set trace 1 division above midscreen.

29. Check/Adjust DVM Zero

- a. Change the V_c Polarity switch to + and turn the FINE COMPARISON VOLTAGE control clockwise to move trace 0.5 division above midscreen.
- b. ADJUST—DVM Zero control R708 carefully so that the V_c reading alternates between 0.000 and 0.001.

30. Check/Adjust +V_c Cal

- a. Turn the COMPARISON VOLTAGE (V_c), COARSE and FINE controls clockwise for a V_c reading of 9.900 volts.
- b. Connect the Precision DC Voltmeter between the V_c OUT jack and ground on the 7A13, and set the voltmeter to measure +10 volts.
- c. ADJUST—The +V_c Cal control R686 to obtain a 9.900 reading on the Precision DC Voltmeter.

31. Check/Adjust -V_c Cal

- a. Change the V_c Polarity switch to -.
- b. ADJUST—The -V_c Cal control R727 to obtain a 9.900 reading on the Precision DC Voltmeter.

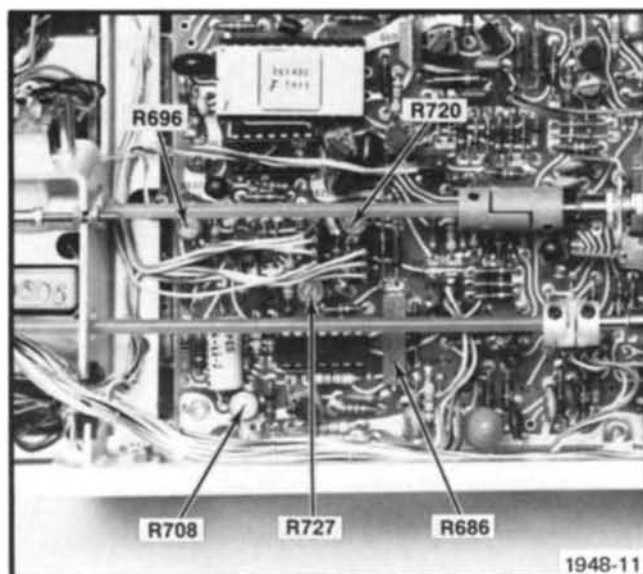

Fig. 5-19. Comparison Voltage adjustment locations on the Output board.

c. CHECK—That the V_C voltage can be adjusted at least 0.015 volt beyond 10 volts by turning the COMPARISON VOLTAGE (V_C), COARSE and FINE controls fully clockwise. Readings should be between 0.015 and 0.150 volts on the LED display.

32. Check $+V_C$ Linearity

a. Change the front panel controls as follows:

(V_C) Polarity	+
+ INPUT	GND
COMPARISON VOLTAGE, COARSE and FINE POSITION control	Fully CCW Trace midscreen

b. Change the + INPUT switch to V_C .

c. Adjust the $+V_C$ Zero control R696, if necessary, to position the trace one division below midscreen.

NOTE

While performing this step, care should be taken to rotate the FINE control slowly when the Precision DC Voltmeter is in the high sensitivity range.

d. CHECK—The $+V_C$ linearity by rotating the COMPARISON VOLTAGE (V_C), COARSE and FINE controls to obtain a null indication at +5.000 volts on the Precision DC Voltmeter. The 7A13 V_C reading should be in the range of

+4.997 to +5.003 volts. When appropriate, increase the sensitivity of the Precision DC Voltmeter to obtain optimum readout resolution.

e. Change the (V_C) Polarity switch to $-$, and repeat part d.

f. Disconnect and turn off the Precision DC Voltmeter.

33. Check Range of Comparison Voltage Fine Control

a. Rotate the COMPARISON VOLTAGE (V_C) FINE control fully counterclockwise. Note V_C readout on 7A13 display.

b. Rotate the FINE control fully clockwise. Note the increased reading by at least 0.030, but no more than 0.040.

34. Check V_C OUT Resistance

a. Set the FINE and COARSE controls to the fully counterclockwise position.

b. Check for 2 k Ω to 5.5 k Ω at the V_C OUT jack.

c. Change the (V_C) Polarity switch to $-$.

d. Check for 2 k Ω to 5.5 k Ω at the V_C OUT jack.

NOISE AND OVERDRIVE RECOVERY CHECKS

Equipment Required

- | | |
|---|--|
| <ol style="list-style-type: none"> 1. Indicator oscilloscope. 2. Time-Base unit. 3. Square-Wave Generator. | <ol style="list-style-type: none"> 4. 10X attenuators. (2) 5. 5X attenuator. 6. 50 ohm termination. 7. 5 ns, 50 ohm coaxial cable. |
|---|--|

When performing a complete procedure, change the following control settings and proceed with step 32.

7A13	
(V _c) Polarity	Pushbuttons canceled
+ INPUT Mode	DC
- INPUT Mode	GND
BW	FULL

Time Base Unit

Triggering Mode	Auto
Time/Div	10 μ s

If the remaining controls need to be checked for proper settings or if step 32 is being used as a starting point for partially calibrating the 7A13, refer to the Preliminary Procedure except as follows:

7A13	
VOLTS/DIV	1 mV

35. Check Noise⁸

a. Set the Type 106 Square-Wave Generator controls as follows:

Repetition Rate	1 kHz
Range	
Multiplier	1
Symmetry	Midrange
+ Transition	Midrange
Amplitude	
Hi Amplitude/Fast Rise	Fast Rise
Rise	
Hi Amplitude	Not applicable
Power	On

b. Apply the 1 kHz signal from the Type 106 + Output connector through two 10X attenuators (connected in series), a 5X attenuator, a 5 ns coaxial cable, and a 50-ohm termination to the 7A13 + INPUT connector.

c. Set the Type 106 + Transition Amplitude control to provide two separate traces on the CRT. Set the Level/Slope control on the Time Base unit to obtain a free-running sweep. These traces are caused by the upper and lower excursions of the square waves being presented on the free running sweep.

d. Rotate the + Transition Amplitude control slowly counterclockwise to just eliminate the dark line between the two traces. Use Fig. 5-20A and B as guides.

e. Set the VOLTS/DIV switch to 10 mV.

f. Remove the two 10X attenuators so that the 5X attenuator is connected to the Type 106 + Output connector. This increases the signal drive by 100 times, allowing more accurate measurement of displayed noise.

g. CHECK—Noise amplitude. Measure the distance between trace centers in millivolts (see Fig. 5-20C). This is the free-running square-wave amplitude. Divide the amplitude in mV by 100. The result should be 400 μ V, or less, noise tangentially measured. Division by 100 compensates for the removed attenuators.

Using Fig. 5-20C as an example, the actual square-wave amplitude is 2.3 divisions or 23 mV. 23 mV divided by 100 is 0.23 mV or 230 μ V of displayed noise. This amplitude is within the 400 μ V noise requirement.

h. Disconnect the signal from the 7A13.

Control Settings

When performing a complete procedure, change the following control settings and proceed with step 36.

7A13	
VOLTS/DIV	2 V

⁸Val Garuts and Charles Samuel, "Measuring Conventional Oscilloscope Noise", Tektronix, Inc., Oregon, 1969. Pages 8—11, April 1969 "Tekscope", Vol. 1, No 2.

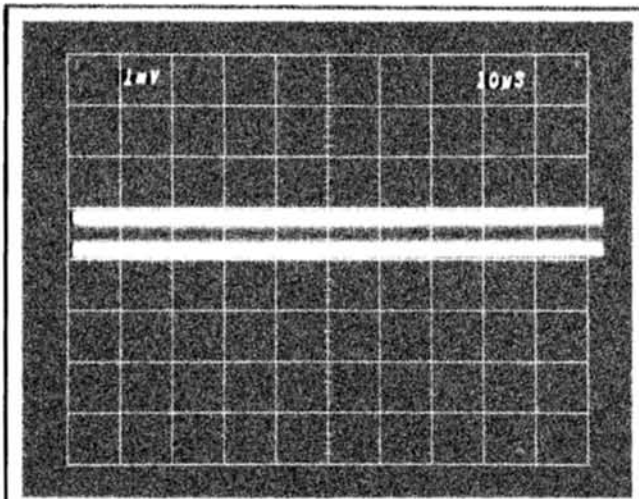

(A) Too much trace separation, step 35d.

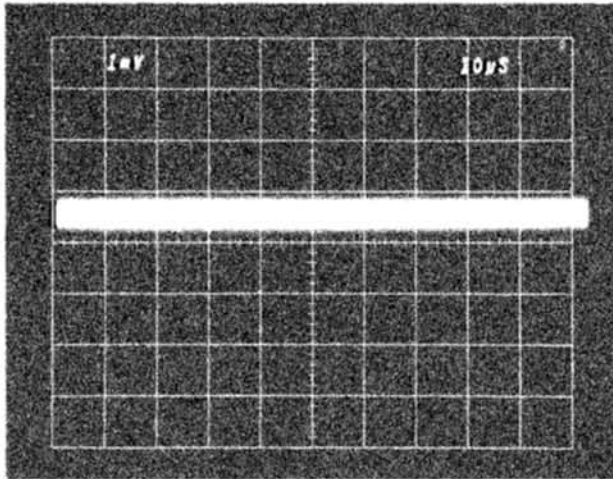

(B) Desired display, step 35d.

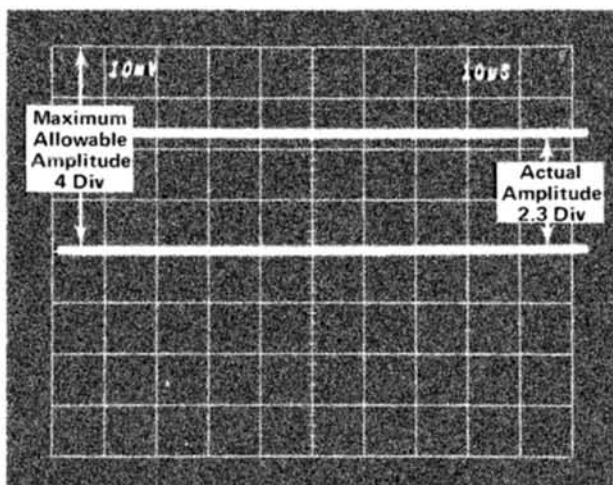

(C) Measuring the square wave amplitude, step 35g.

Fig. 5-20. Noise measurement displays. Sweep rate: 10 μ s/div, free-running.

Time Base Plug-In

Level/Slope (Triggering)	Negative slope region
Triggering Mode	Auto
Time/Div	1 ms

If the remaining controls need to be checked for proper settings, refer to the Preliminary Procedure except as follows:

7A13

+ INPUT Mode	DC
BW	FULL

36. Check Overdrive Recovery Time

a. Connect the Overdrive Recovery test fixture output connector to the 7A13 + INPUT connector.

b. Connect the Overdrive Recovery test fixture power cable to the indicator oscilloscope rear panel Probe Power connector.

c. Set the Overdrive Recovery test fixture Polarity switch to + and the Level control to its fully counterclockwise position.

d. Set the Type 106 controls as follows:

Repetition Rate	100 Hz
Range	
Multiplier	5
Symmetry	Midrange
Amplitude	Midrange
Hi Amplitude/Fast Rise	Hi Amplitude
Fast Rise controls	Not applicable

e. Apply the signal from the Type 106 high amplitude Output connector through a GR-to-BNC adapter and a 42-inch 50-ohm coaxial cable to the Switch Drive connector on the Overdrive Recovery test fixture.

f. Adjust the Type 106 Symmetry, Multiplier, and (if necessary) the Amplitude controls for audible reed resonance.

NOTE

Do not exceed the midrange setting of the Amplitude control. Excessive amplitude will cause the reed drive coil to overheat.

g. Adjust the Overdrive Recovery test fixture Level control to obtain a 5-division display amplitude (see Fig. 5-21A).

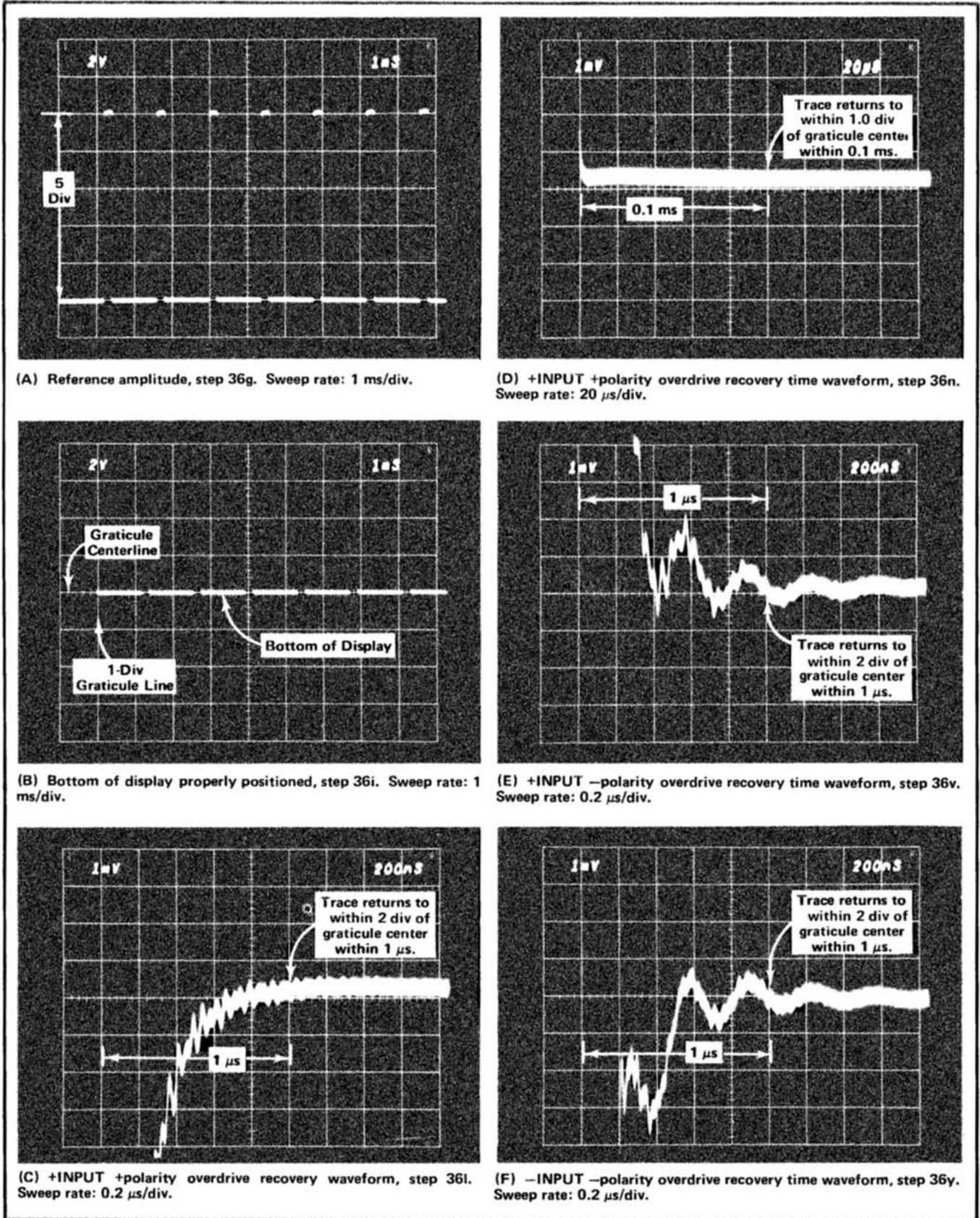

Fig. 5-21. Examples of waveforms obtained when checking overdrive recovery time. Vertical deflection factor for waveforms (A) and (B) is 2 V/div; remaining waveforms are 1 mV/div.

h. If necessary, repeat step 36g to obtain a steady display.

i. Using the position controls, position the bottom of the display to coincide with the graticule centerline and to start at the 1-division graticule line (see Fig. 5-21B).

j. Set the Time/Div switch to $.2 \mu\text{s}$, increase the trace intensity and use the time base Position control to reposition if necessary, the bottom front corner of the display to start at the 1-division graticule line that will be used as a time reference.

k. Set the 7A13 VOLTS/DIV switch to 1 mV. Set the Overdrive Recovery test fixture Polarity switch to '0' and use the POSITION control to position the trace to graticule center. This is the zero amplitude reference. Set the Overdrive Recovery test fixture Polarity switch to +.

l. CHECK—That the trace returns to within 2.0 divisions of graticule vertical center within a recovery time of $1 \mu\text{s}$ (5 horizontal divisions) when measured with respect to the 1-division graticule line as shown in Fig. 5-21C.

m. Set the Time/Div switch to $20 \mu\text{s}$ and decrease the trace intensity.

n. CHECK—That the trace returns to within 1.0 division of graticule vertical center within a recovery time of 0.1 ms. Recovery time is measured with respect to the 1-division graticule line (see Fig. 5-21D).

o. Set the controls as follows:

	7A13
VOLTS/DIV	2 V
	Time Base Plug-In
Level/Slope (Triggering)	Positive slope region
Time/Div	1 ms

Overdrive Recovery Test Fixture

Polarity —

p. Check that the display is 5 divisions in amplitude. If necessary, readjust the Overdrive Recovery test fixture Level control to obtain the proper amplitude.

q. Position the top of the display to coincide with graticule center and to start at the 1-division graticule line.

r. Set the Time/Div switch to $.2 \mu\text{s}$, increase the trace intensity and use the time base Position control to reposition, if necessary, the top front corner of display to start at the 1-division graticule line.

s. Set the 7A13 VOLTS/DIV switch to 1 mV. Set the Overdrive Recovery test fixture Polarity switch to '0' and use the POSITION control to position the trace to graticule center. Set the Overdrive test fixture Polarity switch to +.

t. CHECK—That the trace returns to within 2.0 divisions of graticule vertical center within a recovery time of $1 \mu\text{s}$ when measured with respect to the 1-division graticule line (see Fig. 5-21E).

u. Set the Time/Div switch to $20 \mu\text{s}$ and decrease the trace intensity.

v. CHECK—That the trace returns to within 1.0 division of graticule vertical center within a recovery time of 0.1 ms. Recovery time is measured with respect to the 1-division graticule line as described previously. The waveform will be similar to Fig. 5-21D except that it will be inverted.

w. Set the controls as follows:

	7A13
+ INPUT Mode	GND
- INPUT Mode	DC
VOLTS/DIV	2 V
	Time Base Plug-In
Level/Slope (Triggering)	Negative slope region
Time/Div	1 ms

x. Disconnect the Overdrive Recovery test fixture from the + INPUT connector and reconnect it to the - INPUT connector. Do not change any other connections.

y. CHECK—Using step 36g and steps 36i through 36v as a guide, check the overdrive recovery time for the - INPUT. Fig. 5-21F shows an example of a - INPUT - polarity overdrive recovery time waveform.

z. Disconnect and turn off all equipment.

This completes the Performance Check and Calibration procedure. If removed, replace the side covers on the 7A13; replace the left side and bottom covers on the indicator oscilloscope. If the 7A13 has been completely checked and adjusted to the tolerances given in this procedure, it will meet or exceed the specifications given in Section 1.

REPLACEABLE ELECTRICAL PARTS

PARTS ORDERING INFORMATION

Replacement parts are available from or through your local Tektronix, Inc. Field Office or representative.

Changes to Tektronix instruments are sometimes made to accommodate improved components as they become available, and to give you the benefit of the latest circuit improvements developed in our engineering department. It is therefore important, when ordering parts, to include the following information in your order: Part number, instrument type or number, serial number, and modification number if applicable.

If a part you have ordered has been replaced with a new or improved part, your local Tektronix, Inc. Field Office or representative will contact you concerning any change in part number.

Change information, if any, is located at the rear of this manual.

SPECIAL NOTES AND SYMBOLS

X000 Part first added at this serial number
00X Part removed after this serial number

ITEM NAME

In the Parts List, an Item Name is separated from the description by a colon (:). Because of space limitations, an Item Name may sometimes appear as incomplete. For further Item Name identification, the U.S. Federal Cataloging Handbook H6-1 can be utilized where possible.

ABBREVIATIONS

ACTR	ACTUATOR	PLSTC	PLASTIC
ASSY	ASSEMBLY	QTZ	QUARTZ
CAP	CAPACITOR	RECP	RECEPTACLE
CER	CERAMIC	RES	RESISTOR
CKT	CIRCUIT	RF	RADIO FREQUENCY
COMP	COMPOSITION	SEL	SELECTED
CONN	CONNECTOR	SEMICOND	SEMICONDUCTOR
ELCTLT	ELECTROLYTIC	SENS	SENSITIVE
ELEC	ELECTRICAL	VAR	VARIABLE
INCAND	INCANDESCENT	WW	WIREWOUND
LED	LIGHT EMITTING DIODE	XFMR	TRANSFORMER
NONWIR	NON WIREWOUND	XTAL	CRYSTAL

CROSS INDEX—MFR. CODE NUMBER TO MANUFACTURER

Mfr. Code	Manufacturer	Address	City, State, Zip
00853	SANGAMO ELECTRIC CO., S. CAROLINA DIV.	P O BOX 128	PICKENS, SC 29671
01121	ALLEN-BRADLEY COMPANY	1201 2ND STREET SOUTH	MILWAUKEE, WI 53204
02111	SPECTROL ELECTRONICS CORPORATION	17070 EAST GALE AVENUE	CITY OF INDUSTRY, CA 91745
03508	GENERAL ELECTRIC COMPANY, SEMI-CONDUCTOR PRODUCTS DEPARTMENT	ELECTRONICS PARK	SYRACUSE, NY 13201
04222	AVX CERAMICS, DIVISION OF AVX CORP.	P O BOX 867, 19TH AVE. SOUTH	MYRTLE BEACH, SC 29577
04713	MOTOROLA, INC., SEMICONDUCTOR PROD. DIV.	5005 E MCDOWELL RD, PO BOX 20923	PHOENIX, AZ 85036
07263	FAIRCHILD SEMICONDUCTOR, A DIV. OF FAIRCHILD CAMERA AND INSTRUMENT CORP.	464 ELLIS STREET	MOUNTAIN VIEW, CA 94042
08806	GENERAL ELECTRIC CO., MINIATURE LAMP PRODUCTS DEPARTMENT	NELA PARK	CLEVELAND, OH 44112
11237	CTS KEENE, INC.	3230 RIVERSIDE AVE.	PASO ROBLES, CA 93446
12954	SIEMENS CORPORATION, COMPONENTS GROUP	8700 E THOMAS RD, P O BOX 1390	SCOTTSDALE, AZ 85252
24931	SPECIALTY CONNECTOR CO., INC.	3560 MADISON AVE.	INDIANAPOLIS, IN 46227
32997	BOURNS, INC., TRIMPOT PRODUCTS DIV.	1200 COLUMBIA AVE.	RIVERSIDE, CA 92507
50157	MIDWEST COMPONENTS INC.	P. O. BOX 787	MUSKEGON, MI 49443
56289	SPRAGUE ELECTRIC CO.	1981 PORT CITY BLVD.	NORTH ADAMS, MA 01247
71590	CENTRALAB ELECTRONICS, DIV. OF GLOBE-UNION, INC.	P O BOX 858	FORT DODGE, IA 50501
72982	ERIE TECHNOLOGICAL PRODUCTS, INC.	644 W. 12TH ST.	ERIE, PA 16512
73138	BECKMAN INSTRUMENTS, INC., HELIPOT DIV.	2500 HARBOR BLVD.	FULLERTON, CA 92634
73899	JFD ELECTRONICS COMPONENTS CORP.	PINETREE ROAD	OXFORD, NC 27565
74276	SIGNALITE DIV., GENERAL INSTRUMENT CORP.	1933 HECK AVE.	NEPTUNE, NJ 07753
74970	JOHNSON, E. F., CO.	299 10TH AVE. S. W.	WASECA, MN 56093
75042	TRW ELECTRONIC COMPONENTS, IRC FIXED RESISTORS, PHILADELPHIA DIVISION	401 N. BROAD ST.	PHILADELPHIA, PA 19108
78488	STACKPOLE CARBON CO.	550 DAVISVILLE RD., P O BOX 96	ST. MARYS, PA 15857
79727	C-W INDUSTRIES	P O BOX 500	WARMINISTER, PA 18974
80009	TEKTRONIX, INC.	6135 MAGNOLIA AVE.	BEAVERTON, OR 97077
80294	BOURNS, INC., INSTRUMENT DIV.	9220 SUNSET BLVD.	RIVERSIDE, CA 92506
81483	INTERNATIONAL RECTIFIER CORP.	3029 E. WASHINGTON STREET	LOS ANGELES, CA 90069
90201	MALLORY CAPACITOR CO., DIV. OF P. R. MALLORY AND CO., INC.	P. O. BOX 372	INDIANAPOLIS, IN 46206
91637	DALE ELECTRONICS, INC.	P. O. BOX 609	COLUMBUS, NE 68601

Replaceable Electrical Parts--7A13 (SN B20000 & up)

Ckt No.	Tektronix Part No.	Serial/Model No. Eff	Dscont	Name & Description	Mfr Code	Mfr Part Number
A1	670-1042-02			CKT BOARD ASSY:POLARITY	80009	670-1042-02
A2	670-1073-02			CKT BOARD ASSY:BANDWIDTH	80009	670-1073-02
A3	670-1043-02	B200000	B209999	CKT BOARD ASSY:ATTENUATOR	80009	670-1043-02
A3	670-1043-03	B210000		CKT BOARD ASSY:ATTENUATOR	80009	670-1043-03
A4	670-1044-04	B200000	B229999	CKT BOARD ASSY:OUTPUT	80009	670-1044-04
A4	670-1044-05	B230000	B238699	CKT BOARD ASSY:OUTPUT	80009	670-1044-05
A4	670-1044-06	B238700		CKT BOARD ASSY:OUTPUT	80009	670-1044-06
A5	670-1046-02	B200000	B209999	CKT BOARD ASSY:INPUT	80009	670-1046-02
A5	670-1046-03	B210000		CKT BOARD ASSY:INPUT	80009	670-1046-03
C1	295-0116-00			CAP SET,MATCHED:(2) 0.019UF,MATCHED 0.4% (C1 AND C21 FURNISHED AS A MATCHED PAIR)	80009	295-0116-00
C2	283-0000-00			CAP.,FXD,CER DI:0.001UF,+100-0%,500V	72982	831-516E102P
C3	283-0175-00			CAP.,FXD,CER DI:10PF,5%,200V	72982	8101B210C0G0100J
C4	283-0156-00			CAP.,FXD,CER DI:1000PF,+100-0%,200V	72982	8111A208Z5U0102Z
C5A	281-0064-00			CAP.,VAR,PLSTC:0.25-1.5PF,600V	72982	530-002
C5B	281-0081-00			CAP.,VAR,AIR DI:1.8-13PF,375VDC	74970	189-0506-005
C5C	281-0627-00			CAP.,FXD,CER DI:1PF,+/-0.25PF,500V	72982	301-000C0K0109C
C5D	283-0159-00			CAP.,FXD,CER DI:18PF,5%,50V	72982	8111B065C0G0180J
C6	283-0156-00			CAP.,FXD,CER DI:1000PF,+100-0%,200V	72982	8111A208Z5U0102Z
C7	283-0156-00			CAP.,FXD,CER DI:1000PF,+100-0%,200V	72982	8111A208Z5U0102Z
C8A	281-0064-00			CAP.,VAR,PLSTC:0.25-1.5PF,600V	72982	530-002
C8B	281-0080-00			CAP.,VAR,AIR DI:1.7-11PF,800V	74970	189-5-5
C8C	283-0159-00			CAP.,FXD,CER DI:18PF,5%,50V	72982	8111B065C0G0180J
C8D	283-0160-00			CAP.,FXD,CER DI:1.5PF,10%,50V	72982	8101A058C0K159B
C8E	281-0661-00			CAP.,FXD,CER DI:0.8PF,+/-0.1PF,500V	72982	301-000C0K0808B
C10	283-0156-00			CAP.,FXD,CER DI:1000PF,+100-0%,200V	72982	8111A208Z5U0102Z
C12	283-0177-00			CAP.,FXD,CER DI:1UF,+80-20%,25V	72982	8131N039 E 105Z
C13	-----			(ADDED IF NECESSARY)		
C14	281-0064-00			CAP.,VAR,PLSTC:0.25-1.5PF,600V	72982	530-002
C15	283-0156-00			CAP.,FXD,CER DI:1000PF,+100-0%,200V	72982	8111A208Z5U0102Z
C21	295-0116-00			CAP SET,MATCHED:(2) 0.019UF,MATCHED 0.4% (C1 AND C21 FURNISHED AS A MATCHED PAIR)	80009	295-0116-00
C22	283-0000-00			CAP.,FXD,CER DI:0.001UF,+100-0%,500V	72982	831-516E102P
C23	283-0175-00			CAP.,FXD,CER DI:10PF,5%,200V	72982	8101B210C0G0100J
C24	283-0156-00			CAP.,FXD,CER DI:1000PF,+100-0%,200V	72982	8111A208Z5U0102Z
C25A	281-0064-00			CAP.,VAR,PLSTC:0.25-1.5PF,600V	72982	530-002
C25B	281-0081-00			CAP.,VAR,AIR DI:1.8-13PF,375VDC	74970	189-0506-005
C25C	281-0661-00	B200000	B209999X	CAP.,FXD,CER DI:0.8PF,+/-0.1PF,500V	72982	301-000C0K0808B
C25D	283-0159-00			CAP.,FXD,CER DI:18PF,5%,50V	72982	8111B065C0G0180J
C26	283-0156-00			CAP.,FXD,CER DI:1000PF,+100-0%,200V	72982	8111A208Z5U0102Z
C27	283-0156-00			CAP.,FXD,CER DI:1000PF,+100-0%,200V	72982	8111A208Z5U0102Z
C28A	281-0064-00			CAP.,VAR,PLSTC:0.25-1.5PF,600V	72982	530-002
C28B	281-0080-00			CAP.,VAR,AIR DI:1.7-11PF,800V	74970	189-5-5
C28C	283-0159-00			CAP.,FXD,CER DI:18PF,5%,50V	72982	8111B065C0G0180J
C28D	283-0160-00			CAP.,FXD,CER DI:1.5PF,10%,50V	72982	8101A058C0K159B
C28E	281-0661-00			CAP.,FXD,CER DI:0.8PF,+/-0.1PF,500V	72982	301-000C0K0808B
C30	283-0156-00			CAP.,FXD,CER DI:1000PF,+100-0%,200V	72982	8111A208Z5U0102Z
C31	283-0156-00			CAP.,FXD,CER DI:1000PF,+100-0%,200V	72982	8111A208Z5U0102Z
C32	283-0156-00			CAP.,FXD,CER DI:1000PF,+100-0%,200V	72982	8111A208Z5U0102Z
C33	-----			(ADDED IF NECESSARY)		
C34	281-0064-00			CAP.,VAR,PLSTC:0.25-1.5PF,600V	72982	530-002
C35	283-0000-00			CAP.,FXD,CER DI:0.001UF,+100-0%,500V	72982	831-516E102P
C36	283-0000-00			CAP.,FXD,CER DI:0.001UF,+100-0%,500V	72982	831-516E102P

Replaceable Electrical Parts—7A13 (SN B200000 & up)

Ckt No.	Tektronix Part No.	Serial/Model No. Eff	Dscont	Name & Description	Mfr Code	Mfr Part Number
C38	283-0000-00			CAP., FXD, CER DI:0.001UF, +100-0%, 500V	72982	831-516E102P
C40	283-0000-00	B200000	B229999	CAP., FXD, CER DI:0.001UF, +100-0%, 500V	72982	831-516E102P
C40	283-0346-00	B230000		CAP., FXD, CER DI:0.47UF, +80-20%, 100V	72982	8131-M100F474Z
C42	283-0000-00	B200000	B229999	CAP., FXD, CER DI:0.001UF, +100-0%, 500V	72982	831-516E102P
C42	283-0346-00	B230000		CAP., FXD, CER DI:0.47UF, +80-20%, 100V	72982	8131-M100F474Z
C44	283-0000-00			CAP., FXD, CER DI:0.001UF, +100-0%, 500V	72982	831-516E102P
C45	283-0000-00			CAP., FXD, CER DI:0.001UF, +100-0%, 500V	72982	831-516E102P
C46	283-0000-00			CAP., FXD, CER DI:0.001UF, +100-0%, 500V	72982	831-516E102P
C47	283-0059-00			CAP., FXD, CER DI:1UF, +80-20%, 25V	72982	8131N031Z5U0105Z
C48	283-0059-00			CAP., FXD, CER DI:1UF, +80-20%, 25V	72982	8131N031Z5U0105Z
C49	283-0000-00			CAP., FXD, CER DI:0.001UF, +100-0%, 500V	72982	831-516E102P
C50	283-0032-00			CAP., FXD, CER DI:470PF, 5%, 500V	72982	0831085Z5E00471J
C51	283-0000-00	B200000	B229999X	CAP., FXD, CER DI:0.001UF, +100-0%, 500V	72982	831-516E102P
C52	283-0032-00	B200000	B229999X	CAP., FXD, CER DI:470PF, 5%, 500V	72982	0831085Z5E00471J
C53	283-0000-00	B200000	B229999X	CAP., FXD, CER DI:0.001UF, +100-0%, 500V	72982	831-516E102P
C54	283-0032-00	B200000	B229999X	CAP., FXD, CER DI:470PF, 5%, 500V	72982	0831085Z5E00471J
C55	283-0032-00			CAP., FXD, CER DI:470PF, 5%, 500V	72982	0831085Z5E00471J
C60	283-0000-00			CAP., FXD, CER DI:0.001UF, +100-0%, 500V	72982	831-516E102P
C61	283-0000-00			CAP., FXD, CER DI:0.001UF, +100-0%, 500V	72982	831-516E102P
C63	283-0000-00			CAP., FXD, CER DI:0.001UF, +100-0%, 500V	72982	831-516E102P
C65	283-0000-00			CAP., FXD, CER DI:0.001UF, +100-0%, 500V	72982	831-516E102P
C66	283-0000-00			CAP., FXD, CER DI:0.001UF, +100-0%, 500V	72982	831-516E102P
C70	283-0000-00			CAP., FXD, CER DI:0.001UF, +100-0%, 500V	72982	831-516E102P
C75	283-0000-00			CAP., FXD, CER DI:0.001UF, +100-0%, 500V	72982	831-516E102P
C102	281-0523-00			CAP., FXD, CER DI:100PF, +/-20PF, 500V	72982	301-000U2M0101M
C110	283-0594-00			CAP., FXD, MICA D:0.001UF, 1%, 100V	00853	D151F102F0
C112	283-0594-00			CAP., FXD, MICA D:0.001UF, 1%, 100V	00853	D151F102F0
C113	281-0123-00			CAP., VAR, CER DI:5-25PF, 100V	72982	518-000A5-25
C117	281-0672-00			CAP., FXD, CER DI:11.4PF, 1%, 500V	72982	374017C0G01149F
C122	281-0650-00			CAP., FXD, CER DI:18PF, 10%, 200V	72982	374001C0H180K
C124	281-0064-00			CAP., VAR, PLSTC:0.25-1.5PF, 600V	72982	530-002
C131	283-0651-00			CAP., FXD, MICA D:430PF, 1%, 500V	00853	D155F431F0
C134	281-0064-00			CAP., VAR, PLSTC:0.25-1.5PF, 600V	72982	530-002
C143	283-0026-00			CAP., FXD, CER DI:0.2UF, +80-20%, 25V	56289	274C3
C150	281-0092-00			CAP., VAR, CER DI:9-35PF, 200V	72982	538-011 D9-35
C163	281-0122-00			CAP., VAR, CER DI:2.5-9PF, 100V	72982	518-000A2.5-9
C166	283-0000-00			CAP., FXD, CER DI:0.001UF, +100-0%, 500V	72982	831-516E102P
C170	281-0653-00			CAP., FXD, CER DI:3.3PF, 30%, 200V	72982	374000C0J0339F
C172	283-0000-00			CAP., FXD, CER DI:0.001UF, +100-0%, 500V	72982	831-516E102P
C176	283-0000-00			CAP., FXD, CER DI:0.001UF, +100-0%, 500V	72982	831-516E102P
C178	281-0650-00			CAP., FXD, CER DI:18PF, 10%, 200V	72982	374001C0H180K
C180	281-0534-00			CAP., FXD, CER DI:3.3PF, +/-0.25PF, 500V	72982	301-000C0J0339C
C181	283-0000-00			CAP., FXD, CER DI:0.001UF, +100-0%, 500V	72982	831-516E102P
C183	281-0523-00			CAP., FXD, CER DI:100PF, +/-20PF, 500V	72982	301-000U2M0101M
C187	281-0158-00			CAP., VAR, CER DI:7-45PF, 50V	73899	DVJ-5006
C190	283-0077-00			CAP., FXD, CER DI:330PF, 5%, 500V	56289	40C94A3
C191A	281-0544-00			CAP., FXD, CER DI:5.6PF, 10%, 500V (C191A AND C291A SELECTED AS A PAIR)	72982	301-000C0H0569D
C191B	281-0544-00			CAP., FXD, CER DI:5.6PF, 10%, 500V (C191B AND C291B SELECTED AS A PAIR)	72982	301-000C0H0569D
C197	281-0580-00			CAP., FXD, CER DI:470PF, 10%, 500V	04222	7001-1374
C202	281-0523-00			CAP., FXD, CER DI:100PF, +/-20PF, 500V	72982	301-000U2M0101M
C210	283-0594-00			CAP., FXD, MICA D:0.001UF, 1%, 100V	00853	D151F102F0

Replaceable Electrical Parts—7A13 (SN B20000 & up)

Ckt No.	Tektronix Part No.	Serial/Model No. Eff	Dscont	Name & Description	Mfr Code	Mfr Part Number
C212	283-0594-00			CAP., FXD, MICA D:0.001UF, 1%, 100V	00853	D151F102F0
C213	281-0123-00			CAP., VAR, CER DI:5-25PF, 100V	72982	518-000A5-25
C217	281-0672-00			CAP., FXD, CER DI:11.4PF, 1%, 500V	72982	374017C0G01149F
C222	281-0650-00			CAP., FXD, CER DI:18PF, 10%, 200V	72982	374001C0H180K
C224	281-0064-00			CAP., VAR, PLSTC:0.25-1.5PF, 600V	72982	530-002
C231	283-0651-00			CAP., FXD, MICA D:430PF, 1%, 500V	00853	D155F431F0
C234	281-0064-00			CAP., VAR, PLSTC:0.25-1.5PF, 600V	72982	530-002
C243	283-0026-00			CAP., FXD, CER DI:0.2UF, +80-20%, 25V	56289	274C3
C250	281-0092-00			CAP., VAR, CER DI:9-35PF, 200V	72982	538-011 D9-35
C272	283-0000-00			CAP., FXD, CER DI:0.001UF, +100-0%, 500V	72982	831-516E102P
C278	281-0650-00			CAP., FXD, CER DI:18PF, 10%, 200V	72982	374001C0H180K
C280	281-0534-00			CAP., FXD, CER DI:3.3PF, +/-0.25PF, 500V	72982	301-000C0J0339C
C281	283-0000-00			CAP., FXD, CER DI:0.001UF, +100-0%, 500V	72982	831-516E102P
C283	281-0523-00			CAP., FXD, CER DI:100PF, +/-20PF, 500V	72982	301-000U2M0101M
C290	283-0077-00			CAP., FXD, CER DI:330PF, 5%, 500V	56289	40C94A3
C291A	281-0544-00			CAP., FXD, CER DI:5.6PF, 10%, 500V	72982	301-000C0H0569D
	-----			(C291A AND C191A SELECTED AS A PAIR)		
C291B	281-0544-00			CAP., FXD, CER DI:5.6PF, 10%, 500V	72982	301-000C0H0569D
	-----			(C291B AND C191B SELECTED AS A PAIR)		
C297	281-0580-00			CAP., FXD, CER DI:470PF, 10%, 500V	04222	7001-1374
C300	281-0512-00			CAP., FXD, CER DI:27PF, +/-2.7PF, 500V	72982	308-000C0G0270K
C301	281-0523-00			CAP., FXD, CER DI:100PF, +/-20PF, 500V	72982	301-000U2M0101M
C304	283-0032-00			CAP., FXD, CER DI:470PF, 5%, 500V	72982	0831085Z5E00471J
C308	283-0000-00			CAP., FXD, CER DI:0.001UF, +100-0%, 500V	72982	831-516E102P
C311	281-0523-00			CAP., FXD, CER DI:100PF, +/-20PF, 500V	72982	301-000U2M0101M
C326	283-0108-00			CAP., FXD, CER DI:220PF, 10%, 200V	56289	272C13
C333	281-0512-00			CAP., FXD, CER DI:27PF, +/-2.7PF, 500V	72982	308-000C0G0270K
C336	281-0638-00			CAP., FXD, CER DI:240PF, 5%, 500V	72982	301000Z5D241J
C337	281-0546-00			CAP., FXD, CER DI:330PF, 10%, 500V	04222	7001-1380
C355	281-0623-00			CAP., FXD, CER DI:650PF, 5%, 500V	04222	7001-1362
C364	283-0197-00			CAP., FXD, CER DI:470PF, 5%, 100V	72982	8121N075C0G0471J
C372	281-0512-00			CAP., FXD, CER DI:27PF, +/-2.7PF, 500V	72982	308-000C0G0270K
C374	281-0524-00			CAP., FXD, CER DI:150PF, +/-30PF, 500V	04222	7001-1381
C375	281-0623-00			CAP., FXD, CER DI:650PF, 5%, 500V	04222	7001-1362
C376	283-0000-00			CAP., FXD, CER DI:0.001UF, +100-0%, 500V	72982	831-516E102P
C383	281-0512-00			CAP., FXD, CER DI:27PF, +/-2.7PF, 500V	72982	308-000C0G0270K
C404	283-0032-00			CAP., FXD, CER DI:470PF, 5%, 500V	72982	0831085Z5E00471J
C408	283-0000-00			CAP., FXD, CER DI:0.001UF, +100-0%, 500V	72982	831-516E102P
C411	281-0523-00			CAP., FXD, CER DI:100PF, +/-20PF, 500V	72982	301-000U2M0101M
C426	283-0108-00			CAP., FXD, CER DI:220PF, 10%, 200V	56289	272C13
C432	281-0550-00			CAP., FXD, CER DI:120PF, 10%, 500V	04222	7001-1373
C434	283-0000-00			CAP., FXD, CER DI:0.001UF, +100-0%, 500V	72982	831-516E102P
C437	281-0546-00			CAP., FXD, CER DI:330PF, 10%, 500V	04222	7001-1380
C439	281-0612-00			CAP., FXD, CER DI:5.6PF, +/-0.5PF, 500V	72982	374-001C0H0569D
C455	281-0623-00			CAP., FXD, CER DI:650PF, 5%, 500V	04222	7001-1362
C456	281-0612-00			CAP., FXD, CER DI:5.6PF, +/-0.5PF, 500V	72982	374-001C0H0569D
C463	281-0512-00			CAP., FXD, CER DI:27PF, +/-2.7PF, 500V	72982	308-000C0G0270K
C464	281-0523-00			CAP., FXD, CER DI:100PF, +/-20PF, 500V	72982	301-000U2M0101M
C475	281-0623-00			CAP., FXD, CER DI:650PF, 5%, 500V	04222	7001-1362
C477	281-0612-00			CAP., FXD, CER DI:5.6PF, +/-0.5PF, 500V	72982	374-001C0H0569D
C490	283-0000-00			CAP., FXD, CER DI:0.001UF, +100-0%, 500V	72982	831-516E102P
C491	283-0000-00			CAP., FXD, CER DI:0.001UF, +100-0%, 500V	72982	831-516E102P
C492	281-0523-00			CAP., FXD, CER DI:100PF, +/-20PF, 500V	72982	301-000U2M0101M

Replaceable Electrical Parts—7A13 (SN B200000 & up)

Kct No.	Tektronix Part No.	Serial/Model No. Eff	Dscont	Name & Description	Mfr Code	Mfr Part Number
C494	283-0032-00			CAP., FXD, CER DI:470PF, 5%, 500V	72982	0831085Z5E00471J
C505	290-0340-00			CAP., FXD, ELCTLT: 10UF, 10%, 50V	56289	109D106X9050C2
C506	283-0134-00			CAP., FXD, CER DI:0.47UF, +80-20%, 50V	72982	8131N087Z5U0474Z
C507	283-0000-00			CAP., FXD, CER DI:0.001UF, +100-0%, 500V	72982	831-516E102P
C508	283-0000-00			CAP., FXD, CER DI:0.001UF, +100-0%, 500V	72982	831-516E102P
C509	283-0000-00			CAP., FXD, CER DI:0.001UF, +100-0%, 500V	72982	831-516E102P
C511	283-0001-00			CAP., FXD, CER DI:0.005UF, +100-0%, 500V	72982	831-559E502P
C512	283-0001-00			CAP., FXD, CER DI:0.005UF, +100-0%, 500V	72982	831-559E502P
C514	283-0000-00			CAP., FXD, CER DI:0.001UF, +100-0%, 500V	72982	831-516E102P
C515	283-0000-00			CAP., FXD, CER DI:0.001UF, +100-0%, 500V	72982	831-516E102P
C517	283-0177-00			CAP., FXD, CER DI:1UF, +80-20%, 25V	72982	8131N039 E 105Z
C518	290-0721-00			CAP., FXD, ELCTLT: 100UF, 20%, 20V	56289	196D107X0020TE3
C519	283-0000-00			CAP., FXD, CER DI:0.001UF, +100-0%, 500V	72982	831-516E102P
C520	283-0000-00			CAP., FXD, CER DI:0.001UF, +100-0%, 500V	72982	831-516E102P
C521	283-0000-00			CAP., FXD, CER DI:0.001UF, +100-0%, 500V	72982	831-516E102P
C522	283-0000-00			CAP., FXD, CER DI:0.001UF, +100-0%, 500V	72982	831-516E102P
C527	283-0000-00			CAP., FXD, CER DI:0.001UF, +100-0%, 500V	72982	831-516E102P
C528	283-0178-00			CAP., FXD, CER DI:0.1UF, +80-20%, 100V	72982	8131N145651 104Z
C530	283-0000-00			CAP., FXD, CER DI:0.001UF, +100-0%, 500V	72982	831-516E102P
C532	283-0000-00			CAP., FXD, CER DI:0.001UF, +100-0%, 500V	72982	831-516E102P
C534	283-0000-00			CAP., FXD, CER DI:0.001UF, +100-0%, 500V	72982	831-516E102P
C537	283-0000-00			CAP., FXD, CER DI:0.001UF, +100-0%, 500V	72982	831-516E102P
C538	283-0000-00			CAP., FXD, CER DI:0.001UF, +100-0%, 500V	72982	831-516E102P
C542	283-0177-00			CAP., FXD, CER DI:1UF, +80-20%, 25V	72982	8131N039 E 105Z
C543	283-0000-00			CAP., FXD, CER DI:0.001UF, +100-0%, 500V	72982	831-516E102P
C544	283-0000-00			CAP., FXD, CER DI:0.001UF, +100-0%, 500V	72982	831-516E102P
C545	283-0000-00			CAP., FXD, CER DI:0.001UF, +100-0%, 500V	72982	831-516E102P
C546	283-0000-00			CAP., FXD, CER DI:0.001UF, +100-0%, 500V	72982	831-516E102P
C548	283-0000-00			CAP., FXD, CER DI:0.001UF, +100-0%, 500V	72982	831-516E102P
C549	283-0000-00			CAP., FXD, CER DI:0.001UF, +100-0%, 500V	72982	831-516E102P
C552	283-0134-00			CAP., FXD, CER DI:0.47UF, +80-20%, 50V	72982	8131N087Z5U0474Z
C553	290-0340-00			CAP., FXD, ELCTLT: 10UF, 10%, 50V	56289	109D106X9050C2
C554	283-0000-00			CAP., FXD, CER DI:0.001UF, +100-0%, 500V	72982	831-516E102P
C555	283-0000-00			CAP., FXD, CER DI:0.001UF, +100-0%, 500V	72982	831-516E102P
C557	283-0000-00			CAP., FXD, CER DI:0.001UF, +100-0%, 500V	72982	831-516E102P
C565	290-0139-00			CAP., FXD, ELCTLT: 180UF, 20%, 6V	12954	D180C6M1
C566	283-0177-00			CAP., FXD, CER DI:1UF, +80-20%, 25V	72982	8131N039 E 105Z
C567	290-0114-00			CAP., FXD, ELCTLT: 47UF, 20%, 6V	56289	150D476X0006B2
C568	283-0177-00			CAP., FXD, CER DI:1UF, +80-20%, 25V	72982	8131N039 E 105Z
C569	283-0000-00			CAP., FXD, CER DI:0.001UF, +100-0%, 500V	72982	831-516E102P
C582	283-0000-00			CAP., FXD, CER DI:0.001UF, +100-0%, 500V	72982	831-516E102P
C601	283-0198-00			CAP., FXD, CER DI:0.22UF, 20%, 50V	72982	8121N083Z5U0224M
C603	283-0177-00	XB220000		CAP., FXD, CER DI:1UF, +80-20%, 25V	72982	8131N039 E 105Z
C612	283-0177-00			CAP., FXD, CER DI:1UF, +80-20%, 25V	72982	8131N039 E 105Z
C615	290-0536-00			CAP., FXD, ELCTLT: 10UF, 20%, 25V	90201	TDC106M025FL
C617	290-0536-00			CAP., FXD, ELCTLT: 10UF, 20%, 25V	90201	TDC106M025FL
C625	283-0673-00			CAP., FXD, MICA D:455PF, 1%, 500V	00853	D155F4550F0
C627	283-0673-00			CAP., FXD, MICA D:455PF, 1%, 500V	00853	D155F4550F0
C632	283-0204-00			CAP., FXD, CER DI:0.01UF, 20%, 50V	72982	8121N061Z5U0103M
C668	283-0177-00			CAP., FXD, CER DI:1UF, +80-20%, 25V	72982	8131N039 E 105Z
C670	283-0625-00			CAP., FXD, MICA D:220PF, 1%, 500V	00853	D105F221F0
C671	283-0024-00			CAP., FXD, CER DI:0.1UF, +80-20%, 30V	72982	8121N083Z5U0104Z
C694	283-0177-00			CAP., FXD, CER DI:1UF, +80-20%, 25V	72982	8131N039 E 105Z
C701	283-0024-00			CAP., FXD, CER DI:0.1UF, +80-20%, 30V	72982	8121N083Z5U0104Z

Replaceable Electrical Parts—7A13 (SN B20000 & up)

Ckt No.	Tektronix Part No.	Serial/Model No. Eff	Dscont	Name & Description	Mfr Code	Mfr Part Number
C706	285-0809-00			CAP., FXD, PLSTC: 1UF, 10%, 50V	56289	LP66A1A105K
C743	283-0177-00			CAP., FXD, CER DI: 1UF, +80-20%, 25V	72982	8131N039 E 105Z
CR6	152-0141-02			SEMICONV DEVICE: SILICON, 30V, 50NA	80009	152-0141-02
CR7	152-0141-02			SEMICONV DEVICE: SILICON, 30V, 50NA	80009	152-0141-02
CR35	152-0061-00			SEMICONV DEVICE: SILICON, 175V, 100MA	80009	152-0061-00
CR36	152-0061-00			SEMICONV DEVICE: SILICON, 175V, 100MA	80009	152-0061-00
CR40	152-0141-02			SEMICONV DEVICE: SILICON, 30V, 50NA	80009	152-0141-02
CR41	152-0141-02			SEMICONV DEVICE: SILICON, 30V, 50NA	80009	152-0141-02
CR42	152-0141-02			SEMICONV DEVICE: SILICON, 30V, 50NA	80009	152-0141-02
CR43	152-0141-02			SEMICONV DEVICE: SILICON, 30V, 50NA	80009	152-0141-02
CR44	152-0141-02			SEMICONV DEVICE: SILICON, 30V, 50NA	80009	152-0141-02
CR45	152-0141-02			SEMICONV DEVICE: SILICON, 30V, 50NA	80009	152-0141-02
CR46	152-0141-02			SEMICONV DEVICE: SILICON, 30V, 50NA	80009	152-0141-02
CR47	152-0141-02			SEMICONV DEVICE: SILICON, 30V, 50NA	80009	152-0141-02
CR48	152-0141-02			SEMICONV DEVICE: SILICON, 30V, 50NA	80009	152-0141-02
CR50	152-0141-02	XB230000		SEMICONV DEVICE: SILICON, 30V, 50NA	80009	152-0141-02
CR51	152-0141-02	XB230000		SEMICONV DEVICE: SILICON, 30V, 50NA	80009	152-0141-02
CR53	152-0141-02	XB230000		SEMICONV DEVICE: SILICON, 30V, 50NA	80009	152-0141-02
CR54	152-0141-02	XB230000		SEMICONV DEVICE: SILICON, 30V, 50NA	80009	152-0141-02
CR66	152-0141-02			SEMICONV DEVICE: SILICON, 30V, 50NA	80009	152-0141-02
CR67	152-0141-02			SEMICONV DEVICE: SILICON, 30V, 50NA	80009	152-0141-02
CR77	152-0141-02			SEMICONV DEVICE: SILICON, 30V, 50NA	80009	152-0141-02
CR101	152-0367-00			SEMICONV DEVICE: SILICON, 20V, 20PA	80009	152-0367-00
CR102	152-0061-00			SEMICONV DEVICE: SILICON, 175V, 100MA	80009	152-0061-00
CR110	152-0061-00			SEMICONV DEVICE: SILICON, 175V, 100MA	80009	152-0061-00
CR112	152-0061-00			SEMICONV DEVICE: SILICON, 175V, 100MA	80009	152-0061-00
CR134	152-0061-00			SEMICONV DEVICE: SILICON, 175V, 100MA	80009	152-0061-00
CR150	153-0039-01			SEMICONV DVC SE: SILICON, MATCHED PAIR (CR150 AND CR250 FURNISHED AS A MATCHED PAIR)	80009	153-0039-01
CR152	152-0141-02			SEMICONV DEVICE: SILICON, 30V, 50NA	80009	152-0141-02
CR154	152-0141-02			SEMICONV DEVICE: SILICON, 30V, 50NA	80009	152-0141-02
CR155	152-0141-02			SEMICONV DEVICE: SILICON, 30V, 50NA	80009	152-0141-02
CR156	152-0141-02			SEMICONV DEVICE: SILICON, 30V, 50NA	80009	152-0141-02
CR157	152-0141-02			SEMICONV DEVICE: SILICON, 30V, 50NA	80009	152-0141-02
CR158	152-0141-02			SEMICONV DEVICE: SILICON, 30V, 50NA	80009	152-0141-02
CR159	152-0141-02			SEMICONV DEVICE: SILICON, 30V, 50NA	80009	152-0141-02
CR182	152-0141-02			SEMICONV DEVICE: SILICON, 30V, 50NA	80009	152-0141-02
CR201	152-0367-00			SEMICONV DEVICE: SILICON, 20V, 20PA	80009	152-0367-00
CR202	152-0061-00			SEMICONV DEVICE: SILICON, 175V, 100MA	80009	152-0061-00
CR210	152-0061-00			SEMICONV DEVICE: SILICON, 175V, 100MA	80009	152-0061-00
CR212	152-0061-00			SEMICONV DEVICE: SILICON, 175V, 100MA	80009	152-0061-00
CR234	152-0061-00			SEMICONV DEVICE: SILICON, 175V, 100MA	80009	152-0061-00
CR250	153-0039-01			SEMICONV DVC SE: SILICON, MATCHED PAIR (CR150 AND CR250 FURNISHED AS A MATCHED PAIR)	80009	153-0039-01
CR252	152-0141-02			SEMICONV DEVICE: SILICON, 30V, 50NA	80009	152-0141-02
CR282	152-0141-02			SEMICONV DEVICE: SILICON, 30V, 50NA	80009	152-0141-02
CR364	152-0141-02			SEMICONV DEVICE: SILICON, 30V, 50NA	80009	152-0141-02
CR365	152-0141-02			SEMICONV DEVICE: SILICON, 30V, 50NA	80009	152-0141-02
CR401	152-0271-00			SEMICONV DEVICE: SILICON, 10PF	80009	152-0271-00
CR641	152-0141-02			SEMICONV DEVICE: SILICON, 30V, 50NA	80009	152-0141-02
CR645	152-0141-02			SEMICONV DEVICE: SILICON, 30V, 50NA	80009	152-0141-02
CR649	152-0141-02			SEMICONV DEVICE: SILICON, 30V, 50NA	80009	152-0141-02

Replaceable Electrical Parts—7A13 (SN B200000 & up)

Ckt No.	Tektronix Part No.	Serial/Model No. Eff	Dscont	Name & Description	Mfr Code	Mfr Part Number
CR651	152-0141-02			SEMICON D DEVICE:SILICON,30V,50NA	80009	152-0141-02
CR653	152-0141-02			SEMICON D DEVICE:SILICON,30V,50NA	80009	152-0141-02
CR655	152-0141-02			SEMICON D DEVICE:SILICON,30V,50NA	80009	152-0141-02
CR702	152-0246-00			SEMICON D DEVICE:SILICON,400PIV,200MA	80009	152-0246-00
CR715	152-0141-02			SEMICON D DEVICE:SILICON,30V,50NA	80009	152-0141-02
CR718	152-0141-02			SEMICON D DEVICE:SILICON,30V,50NA	80009	152-0141-02
DS1	150-0048-01			LAMP, INCAND: 5V, 0.06A, SEL	08806	683AS15
DS10	150-0048-01			LAMP, INCAND: 5V, 0.06A, SEL	08806	683AS15
DS21	150-0048-01			LAMP, INCAND: 5V, 0.06A, SEL	08806	683AS15
DS47	150-0084-00			LAMP, GLOW: NEON	74276	2AA
DS570	150-0048-01			LAMP, INCAND: 5V, 0.06A, SEL	08806	683AS15
J1	131-0679-02			CONNECTOR, RCPT, :BNC, MALE, 3 CONTACT	24931	28JR270-1
J21	131-0679-02			CONNECTOR, RCPT, :BNC, MALE, 3 CONTACT	24931	28JR270-1
K6	148-0055-00			RELAY, ARMATURE: SPDT AND SPST, 15V DC	80009	148-0055-00
K7	148-0054-00			RELAY, ARMATURE: SPDT AND SPST, 15V DC	80009	148-0054-00
K10	148-0050-00			RELAY, ARMATURE: SPST, 12V DC	80009	148-0050-00
K26	148-0055-00			RELAY, ARMATURE: SPDT AND SPST, 15V DC	80009	148-0055-00
K27	148-0054-00			RELAY, ARMATURE: SPDT AND SPST, 15V DC	80009	148-0054-00
K30	148-0050-00			RELAY, ARMATURE: SPST, 12V DC	80009	148-0050-00
K47	148-0034-00			RELAY, ARMATURE: DPDT, 15VDC, 600 OHM	80009	148-0034-00
K48	148-0034-00			RELAY, ARMATURE: DPDT, 15VDC, 600 OHM	80009	148-0034-00
K60	148-0035-00			RELAY, ARMATURE: SPDT, 15VDC, 600 OHM	80009	148-0035-00
K61	148-0035-00			RELAY, ARMATURE: SPDT, 15VDC, 600 OHM	80009	148-0035-00
K480	148-0034-00			RELAY, ARMATURE: DPDT, 15VDC, 600 OHM	80009	148-0034-00
K490	148-0034-00			RELAY, ARMATURE: DPDT, 15VDC, 600 OHM	80009	148-0034-00
L2	108-0536-00			COIL, RF: 165UH (BLUE)	80009	108-0536-00
L4	108-0535-00			COIL, RF: 165UH (BROWN)	80009	108-0535-00
L25	-----			(FURNISHED AS A UNIT WITH MAIN CHASSIS CABLE)		
L26	-----			(FURNISHED AS A UNIT WITH MAIN CHASSIS CABLE)		
L27	-----			(FURNISHED AS A UNIT WITH MAIN CHASSIS CABLE)		
L40	-----			(FURNISHED AS A UNIT WITH MAIN CHASSIS CABLE)		
L42	-----			(FURNISHED AS A UNIT WITH MAIN CHASSIS CABLE)		
L364	108-0095-00			COIL, RF: 1.4UH	80009	108-0095-00
L384	108-0095-00			COIL, RF: 1.4UH	80009	108-0095-00
L464	108-0095-00			COIL, RF: 1.4UH	80009	108-0095-00
L484	108-0095-00			COIL, RF: 1.4UH	80009	108-0095-00
L503	276-0507-00			SHIELDING BEAD, :0.6UH	78488	57-0180-7D 500B
L505	276-0507-00			SHIELDING BEAD, :0.6UH	78488	57-0180-7D 500B
L515	276-0507-00			SHIELDING BEAD, :0.6UH	78488	57-0180-7D 500B
L517	276-0507-00			SHIELDING BEAD, :0.6UH	78488	57-0180-7D 500B
L538	108-0520-00			COIL, RF: 2.2UH (WOUND ON A 10 OHM RES)	80009	108-0520-00
L540	276-0507-00			SHIELDING BEAD, :0.6UH	78488	57-0180-7D 500B
L542	276-0507-00			SHIELDING BEAD, :0.6UH	78488	57-0180-7D 500B
L550	276-0507-00			SHIELDING BEAD, :0.6UH	78488	57-0180-7D 500B
L552	276-0507-00			SHIELDING BEAD, :0.6UH	78488	57-0180-7D 500B
L563	276-0507-00			SHIELDING BEAD, :0.6UH	78488	57-0180-7D 500B

Replaceable Electrical Parts—7A13 (SN B200000 & up)

Ckt No.	Tektronix Part No.	Serial/Model No. Eff	Dscont	Name & Description	Mfr Code	Mfr Part Number
L564	120-0382-00			XFMR, TOROID: 14 TURNS, SINGLE	80009	120-0382-00
L565	276-0507-00			SHIELDING BEAD, :0.6UH	78488	57-0180-7D 500B
L566	276-0507-00			SHIELDING BEAD, :0.6UH	78488	57-0180-7D 500B
L567	120-0382-00			XFMR, TOROID: 14 TURNS, SINGLE	80009	120-0382-00
L568	276-0507-00			SHIELDING BEAD, :0.6UH	78488	57-0180-7D 500B
L668	108-0440-00			COIL, RF: 8UH, TOROIDAL INDUCTOR	80009	108-0440-00
LR60	108-0520-00			COIL, RF: 2.2UH (WOUND ON A 10 OHM RES)	80009	108-0520-00
LR504	108-0537-00			COIL, RF: 200UH	80009	108-0537-00
LR507	108-0520-00			COIL, RF: 2.2UH (WOUND ON A 10 OHM RES)	80009	108-0520-00
LR508	108-0520-00			COIL, RF: 2.2UH (WOUND ON A 10 OHM RES)	80009	108-0520-00
LR509	108-0520-00			COIL, RF: 2.2UH (WOUND ON A 10 OHM RES)	80009	108-0520-00
LR511	108-0519-00			COIL, RF: 2.2UH	80009	108-0519-00
LR512	108-0519-00			COIL, RF: 2.2UH	80009	108-0519-00
LR514	108-0520-00			COIL, RF: 2.2UH (WOUND ON A 10 OHM RES)	80009	108-0520-00
LR516	108-0537-00			COIL, RF: 200UH	80009	108-0537-00
LR520	108-0520-00			COIL, RF: 2.2UH (WOUND ON A 10 OHM RES)	80009	108-0520-00
LR527	108-0520-00			COIL, RF: 2.2UH (WOUND ON A 10 OHM RES)	80009	108-0520-00
LR530	108-0520-00			COIL, RF: 2.2UH (WOUND ON A 10 OHM RES)	80009	108-0520-00
LR537	108-0520-00			COIL, RF: 2.2UH (WOUND ON A 10 OHM RES)	80009	108-0520-00
LR541	108-0537-00			COIL, RF: 200UH	80009	108-0537-00
LR544	108-0520-00			COIL, RF: 2.2UH (WOUND ON A 10 OHM RES)	80009	108-0520-00
LR545	108-0520-00			COIL, RF: 2.2UH (WOUND ON A 10 OHM RES)	80009	108-0520-00
LR546	108-0520-00			COIL, RF: 2.2UH (WOUND ON A 10 OHM RES)	80009	108-0520-00
LR548	108-0520-00			COIL, RF: 2.2UH (WOUND ON A 10 OHM RES)	80009	108-0520-00
LR549	108-0520-00			COIL, RF: 2.2UH (WOUND ON A 10 OHM RES)	80009	108-0520-00
LR551	108-0537-00			COIL, RF: 200UH	80009	108-0537-00
LR554	108-0520-00			COIL, RF: 2.2UH (WOUND ON A 10 OHM RES)	80009	108-0520-00
LR555	108-0520-00			COIL, RF: 2.2UH (WOUND ON A 10 OHM RES)	80009	108-0520-00
LR557	108-0520-00			COIL, RF: 2.2UH (WOUND ON A 10 OHM RES)	80009	108-0520-00
LR569	108-0520-00			COIL, RF: 2.2UH (WOUND ON A 10 OHM RES)	80009	108-0520-00
LR615	108-0114-00			COIL, RF: 6UH	80009	108-0114-00
Q20	151-0276-00			TRANSISTOR: SILICON, PNP	80009	151-0276-00
Q40	151-0254-00			TRANSISTOR: SILICON, NPN	80009	151-0254-00
Q40	151-0281-00	B200000	B236909	TRANSISTOR: SILICON, NPN	03508	X16P4039
Q60	151-0192-00			TRANSISTOR: SILICON, NPN, SEL FROM MPS6521	80009	151-0192-00
Q65	151-0254-00			TRANSISTOR: SILICON, NPN	80009	151-0254-00
Q70	151-0254-00			TRANSISTOR: SILICON, NPN	80009	151-0254-00
Q75	151-0254-00			TRANSISTOR: SILICON, NPN	80009	151-0254-00
Q105	151-0220-00			TRANSISTOR: SILICON, PNP	80009	151-0220-00
Q110	151-0250-00			TRANSISTOR: SILICON, NPN	80009	151-0250-00
Q115	153-0574-00			SEMICON DVC SE: SILICON, NPN	80009	153-0574-00
	-----			(Q115 AND Q215 FURNISHED AS A MATCHED PAIR)		
Q118	153-0633-00			SEMICON DVC SE: SILICON, NPN	80009	153-0633-00
	-----			(Q118 AND Q218 FURNISHED AS A MATCHED PAIR)		
Q120	153-0559-00			SEMICON DVC SE: SILICON, FE	80009	153-0559-00
	-----			(Q120 AND Q220 FURNISHED AS A MATCHED PAIR)		
Q130	151-0268-00			TRANSISTOR: SILICON, NPN, DUAL	80009	151-0268-00
Q140	151-0220-00			TRANSISTOR: SILICON, PNP	80009	151-0220-00
Q145	153-0576-00			SEMICON DVC SE: SILICON, NPN	80009	153-0576-00
	-----			(Q145 AND Q245 FURNISHED AS A MATCHED PAIR)		
Q152	153-0575-00			SEMICON DVC SE: SILICON, NPN	80009	153-0575-00
	-----			(Q152 AND Q252 FURNISHED AS A MATCHED PAIR)		

Replaceable Electrical Parts—7A13 (SN B200000 & up)

Ckt No.	Tektronix Part No.	Serial/Model No. Eff	Dscont	Name & Description	Mfr Code	Mfr Part Number
Q160	151-0268-00			TRANSISTOR:SILICON,NPN,DUAL	80009	151-0268-00
Q165	151-0220-00			TRANSISTOR:SILICON,PNP	80009	151-0220-00
Q170	153-0574-00			SEMICONDCVCSE:SILICON,NPN	80009	153-0574-00
	-----			(Q170 AND Q270 FURNISHED AS A MATCHED PAIR)		
Q180	151-0190-01			TRANSISTOR:SILICON,NPN	80009	151-0190-01
Q182	151-0221-00			TRANSISTOR:SILICON,PNP	80009	151-0221-00
Q185	151-0272-00			TRANSISTOR:SILICON,PNP	80009	151-0272-00
Q195	151-0272-00			TRANSISTOR:SILICON,PNP	80009	151-0272-00
Q205	151-0220-00			TRANSISTOR:SILICON,PNP	80009	151-0220-00
Q210	151-0250-00			TRANSISTOR:SILICON,NPN	80009	151-0250-00
Q215	153-0574-00			SEMICONDCVCSE:SILICON,NPN	80009	153-0574-00
	-----			(Q115 AND Q215 FURNISHED AS A MATCHED PAIR)		
Q218	153-0633-00			SEMICONDCVCSE:SILICON,NPN	80009	153-0633-00
	-----			(Q118 AND Q218 FURNISHED AS A MATCHED PAIR)		
Q220	153-0559-00			SEMICONDCVCSE:SILICON,FE	80009	153-0559-00
	-----			(Q120 AND Q220 FURNISHED AS A MATCHED PAIR)		
Q240	151-0220-00			TRANSISTOR:SILICON,PNP	80009	151-0220-00
Q245	153-0576-00			SEMICONDCVCSE:SILICON,NPN	80009	153-0576-00
	-----			(Q145 AND Q245 FURNISHED AS A MATCHED PAIR)		
Q252	153-0575-00			SEMICONDCVCSE:SILICON,NPN	80009	153-0575-00
	-----			(Q152 AND Q252 FURNISHED AS A MATCHED PAIR)		
Q255	151-0103-00			TRANSISTOR:SILICON,NPN	80009	151-0103-00
Q258	151-0220-00			TRANSISTOR:SILICON,PNP	80009	151-0220-00
Q270	153-0574-00			SEMICONDCVCSE:SILICON,NPN	80009	153-0574-00
	-----			(Q170 AND Q270 FURNISHED AS A MATCHED PAIR)		
Q280	151-0190-01			TRANSISTOR:SILICON,NPN	80009	151-0190-01
Q282	151-0221-00			TRANSISTOR:SILICON,PNP	80009	151-0221-00
Q300	151-0268-00			TRANSISTOR:SILICON,NPN,DUAL	80009	151-0268-00
Q320	151-0267-00			TRANSISTOR:SILICON,NPN	80009	151-0267-00
Q330	151-0434-00	B200000	B238699	TRANSISTOR:SILICON,PNP	80009	151-0434-00
Q330	151-0221-00	B238700		TRANSISTOR:SILICON,PNP	80009	151-0221-00
Q340	151-0434-00	B200000	B238699	TRANSISTOR:SILICON,PNP	80009	151-0434-00
Q340	151-0221-00	B238700		TRANSISTOR:SILICON,PNP	80009	151-0221-00
Q350	151-0212-00			TRANSISTOR:SILICON,NPN	80009	151-0212-00
Q360	151-0259-00			TRANSISTOR:SILICON,NPN	80009	151-0259-00
Q370	151-0212-00			TRANSISTOR:SILICON,NPN	80009	151-0212-00
Q380	151-0259-00			TRANSISTOR:SILICON,NPN	80009	151-0259-00
Q430	151-0434-00	B200000	B238699	TRANSISTOR:SILICON,PNP	80009	151-0434-00
Q430	151-0221-00	B238700		TRANSISTOR:SILICON,PNP	80009	151-0221-00
Q440	151-0434-00	B200000	B238699	TRANSISTOR:SILICON,PNP	80009	151-0434-00
Q440	151-0221-00	B238700		TRANSISTOR:SILICON,PNP	80009	151-0221-00
Q450	151-0212-00			TRANSISTOR:SILICON,NPN	80009	151-0212-00
Q460	151-0259-00			TRANSISTOR:SILICON,NPN	80009	151-0259-00
Q470	151-0212-00			TRANSISTOR:SILICON,NPN	80009	151-0212-00
Q480	151-0259-00			TRANSISTOR:SILICON,NPN	80009	151-0259-00
Q500	151-0220-00			TRANSISTOR:SILICON,PNP	80009	151-0220-00
Q505	151-0260-00			TRANSISTOR:SILICON,NPN	80009	151-0260-00
Q520	151-0190-01			TRANSISTOR:SILICON,NPN	80009	151-0190-01
Q530	151-0220-00			TRANSISTOR:SILICON,PNP	80009	151-0220-00
Q604	151-0188-00			TRANSISTOR:SILICON,PNP	80009	151-0188-00
Q607	151-0188-00			TRANSISTOR:SILICON,PNP	80009	151-0188-00
Q611	151-0331-00			TRANSISTOR:SILICON,NPN	80009	151-0331-00
Q623	151-0190-00			TRANSISTOR:SILICON,NPN	80009	151-0190-00
Q629	151-0190-00			TRANSISTOR:SILICON,NPN	80009	151-0190-00
Q632	151-0190-00			TRANSISTOR:SILICON,NPN	80009	151-0190-00
Q637	151-0254-00			TRANSISTOR:SILICON,NPN	80009	151-0254-00
Q640	151-0254-00			TRANSISTOR:SILICON,NPN	80009	151-0254-00

Replaceable Electrical Parts—7A13 (SN B20000 & up)

Ckt No.	Tektronix Part No.	Serial/Model No. Eff	Discont	Name & Description	Mfr Code	Mfr Part Number
Q644	151-0254-00			TRANSISTOR:SILICON,NPN	80009	151-0254-00
Q648	151-0254-00			TRANSISTOR:SILICON,NPN	80009	151-0254-00
Q658	151-0220-00			TRANSISTOR:SILICON,PNP	80009	151-0220-00
Q676	151-0190-00			TRANSISTOR:SILICON,NPN	80009	151-0190-00
Q717	151-0190-00			TRANSISTOR:SILICON,NPN	80009	151-0190-00
R1	315-0105-00			RES.,FXD,CMPSN:1M OHM,5%,0.25W	01121	CB1055
R2	307-0112-00			RES.,FXD,CMPSN:4.3 OHM,5%,0.25W	01121	CB43G5
R3	315-0470-00			RES.,FXD,CMPSN:47 OHM,5%,0.25W	01121	CB4705
R5A	325-0004-00			RES.,SET,MTCHD:900K OHM,0.1%,0.25W (R5A FURNISHED AS A MATCHED PAIR WITH R25A)	91637	SPR-426
R5C	317-0111-00	B200000	B209999	RES.,FXD,CMPSN:110 OHM,5%,0.125W	01121	BB1115
R5C	317-0201-00	B210000		RES.,FXD,CMPSN:200 OHM,5%,0.125W	01121	BB2015
R5D	325-0020-00			RES.,SET,MTCHD:110.6K OHM,0.1%,0.125W (R5D FURNISHED AS A MATCHED PAIR WITH R25D)	91637	SPR ARO
R5E	311-0635-00			RES.,VAR,NONWIR:1K OHM,10%,0.50W	73138	82-32-0
R6	322-0625-03			RES.,FXD,FILM:995K OHM,0.25%,0.25W	91637	MFF1421D99502C
R7	311-0607-00			RES.,VAR,NONWIR:10K OHM,10%,0.50W	73138	82P-59-4-103K
R8A	325-0004-00			RES.,SET,MTCHD:900K OHM,0.1%,0.25W (R8A FURNISHED AS A MATCHED PAIR WITH R28A)	91637	SPR-426
R8D	315-0511-00			RES.,FXD,CMPSN:510 OHM,5%,0.25W	01121	CB5115
R8E	317-0241-00	B200000	B209999	RES.,FXD,CMPSN:240 OHM,5%,0.125W	01121	BB2415
R8E	317-0151-00	B210000		RES.,FXD,CMPSN:150 OHM,5%,0.125W	01121	BB1515
R8F	325-0038-00			RES.,SET,MTCHD:110.8K OHM,0.1%,0.125W (R8F FURNISHED AS A MATCHED PAIR WITH R28F)	91637	SPR359110.8K
R8G	311-0634-00			RES.,VAR,NONWIR:500 OHM,10%,0.50W	73138	82-31-0
R10	315-0101-00			RES.,FXD,CMPSN:100 OHM,5%,0.25W	01121	CB1015
R14	315-0751-00			RES.,FXD,CMPSN:750 OHM,5%,0.25W	01121	CB7515
R20	315-0473-00			RES.,FXD,CMPSN:47K OHM,5%,0.25W	01121	CB4735
R21	315-0105-00			RES.,FXD,CMPSN:1M OHM,5%,0.25W	01121	CB1055
R22	307-0112-00			RES.,FXD,CMPSN:4.3 OHM,5%,0.25W	01121	CB43G5
R23	315-0470-00			RES.,FXD,CMPSN:47 OHM,5%,0.25W	01121	CB4705
R25A	325-0004-00			RES.,SET,MTCHD:900K OHM,0.1%,0.25W (R25A FURNISHED AS A MATCHED PAIR WITH R5A)	91637	SPR-426
R25B	317-0511-00	XB210000		RES.,FXD,CMPSN:510 OHM,5%,0.125W	01121	BB5115
R25C	317-0201-00			RES.,FXD,CMPSN:200 OHM,5%,0.125W	01121	BB2015
R25D	325-0020-00			RES.,SET,MTCHD:110.6K OHM,0.1%,0.125W (R25D FURNISHED AS A MATCHED PAIR WITH R5D)	91637	SPR ARO
R26	322-0625-03			RES.,FXD,FILM:995K OHM,0.25%,0.25W	91637	MFF1421D99502C
R27	311-0607-00			RES.,VAR,NONWIR:10K OHM,10%,0.50W	73138	82P-59-4-103K
R28A	325-0004-00			RES.,SET,MTCHD:900K OHM,0.1%,0.25W (R28A FURNISHED AS A MATCHED PAIR WITH R8A)	91637	SPR-426
R28D	315-0511-00			RES.,FXD,CMPSN:510 OHM,5%,0.25W	01121	CB5115
R28E	317-0151-00			RES.,FXD,CMPSN:150 OHM,5%,0.125W	01121	BB1515
R28F	325-0038-00			RES.,SET,MTCHD:110.8K OHM,0.1%,0.125W (R28F FURNISHED AS A MATCHED PAIR WITH R8F)	91637	SPR359110.8K
R28G	311-0634-00			RES.,VAR,NONWIR:500 OHM,10%,0.50W	73138	82-31-0
R30	315-0101-00			RES.,FXD,CMPSN:100 OHM,5%,0.25W	01121	CB1015
R34	315-0162-00			RES.,FXD,CMPSN:1.6K OHM,5%,0.25W	01121	CB1625
R35	315-0153-00			RES.,FXD,CMPSN:15K OHM,5%,0.25W	01121	CB1535
R36	315-0363-00			RES.,FXD,CMPSN:36K OHM,5%,0.25W	01121	CB3635
R38	315-0104-00			RES.,FXD,CMPSN:100K OHM,5%,0.25W	01121	CB1045
R40	321-0223-00			RES.,FXD,FILM:2.05K OHM,1%,0.125W	91637	MFF1816G20500F
R41	315-0101-00			RES.,FXD,CMPSN:100 OHM,5%,0.25W	01121	CB1015

Replaceable Electrical Parts—7A13 (SN B20000 & up)

Ckt No.	Tektronix Part No.	Serial/Model No. Eff	Dscont	Name & Description	Mfr Code	Mfr Part Number
R42	321-0223-00			RES., FXD, FILM: 2.05K OHM, 1%, 0.125W	91637	MFF1816G20500F
R45	315-0123-00			RES., FXD, CMPSN: 12K OHM, 5%, 0.25W	01121	CB1235
R46	321-0299-00			RES., FXD, FILM: 12.7K OHM, 1%, 0.125W	91637	MFF1816G12701F
R47	315-0151-00			RES., FXD, CMPSN: 150 OHM, 5%, 0.25W	01121	CB1515
R49	317-0151-00	XB230000		RES., FXD, CMPSN: 150 OHM, 5%, 0.125W	01121	BB1515
R50	317-0151-00	XB230000		RES., FXD, CMPSN: 150 OHM, 5%, 0.125W	01121	BB1515
R51A	315-0154-00			RES., FXD, CMPSN: 150K OHM, 5%, 0.25W	01121	CB1545
R51B	315-0753-00			RES., FXD, CMPSN: 75K OHM, 5%, 0.25W	01121	CB7535
R52A	321-0344-00			RES., FXD, FILM: 37.4K OHM, 1%, 0.125W	91637	MFF1816G37401F
R52B	315-0154-00			RES., FXD, CMPSN: 150K OHM, 5%, 0.25W	01121	CB1545
R53	315-0753-00			RES., FXD, CMPSN: 75K OHM, 5%, 0.25W	01121	CB7535
R54	315-0154-00			RES., FXD, CMPSN: 150K OHM, 5%, 0.25W	01121	CB1545
R55	315-0513-00			RES., FXD, CMPSN: 51K OHM, 5%, 0.25W	01121	CB5135
R56	315-0753-00			RES., FXD, CMPSN: 75K OHM, 5%, 0.25W	01121	CB7535
R57	315-0154-00			RES., FXD, CMPSN: 150K OHM, 5%, 0.25W	01121	CB1545
R58	315-0753-00			RES., FXD, CMPSN: 75K OHM, 5%, 0.25W	01121	CB7535
R59	321-0344-00			RES., FXD, FILM: 37.4K OHM, 1%, 0.125W	91637	MFF1816G37401F
R61	315-0822-00			RES., FXD, CMPSN: 8.2K OHM, 5%, 0.25W	01121	CB8225
R63	321-0271-00			RES., FXD, FILM: 6.49K OHM, 1%, 0.125W	91637	MFF1816G64900F
R64	321-0352-00			RES., FXD, FILM: 45.3K OHM, 1%, 0.125W	91637	MFF1816G45301F
R65	321-0404-00			RES., FXD, FILM: 158K OHM, 1%, 0.125W	91637	MFF1816G15802F
R66	321-0434-00			RES., FXD, FILM: 324K OHM, 1%, 0.125W	91637	MFF1816G32402F
R71	321-0349-00			RES., FXD, FILM: 42.2K OHM, 1%, 0.125W	91637	MFF1816G42201F
R72	315-0302-00			RES., FXD, CMPSN: 3K OHM, 5%, 0.25W	01121	CB3025
R73	321-0281-00			RES., FXD, FILM: 8.25K OHM, 1%, 0.125W	91637	MFF1816G82500F
R74	321-0377-00			RES., FXD, FILM: 82.5K OHM, 1%, 0.125W	91637	MFF1816G82501F
R75	321-0297-00			RES., FXD, FILM: 12.1K OHM, 1%, 0.125W	91637	MFF1816G12101F
R76	315-0512-00			RES., FXD, CMPSN: 5.1K OHM, 5%, 0.25W	01121	CB5125
R77	321-0347-00			RES., FXD, FILM: 40.2K OHM, 1%, 0.125W	91637	MFF1816G40201F
R103	315-0104-00			RES., FXD, CMPSN: 100K OHM, 5%, 0.25W	01121	CB1045
R104	323-0318-00			RES., FXD, FILM: 20K OHM, 1%, 0.50W	91637	MFF1226D20001F
R105	315-0221-00			RES., FXD, CMPSN: 220 OHM, 5%, 0.25W	01121	CB2215
R109	323-0304-00			RES., FXD, FILM: 14.3K OHM, 1%, 0.50W	75042	CECT0-1432F
R112	321-0276-00			RES., FXD, FILM: 7.32K OHM, 1%, 0.125W	91637	MFF1816G73200F
R113	315-0750-00			RES., FXD, CMPSN: 75 OHM, 5%, 0.25W	01121	CB7505
R115	315-0101-00			RES., FXD, CMPSN: 100 OHM, 5%, 0.25W	01121	CB1015
R117	315-0222-00			RES., FXD, CMPSN: 2.2K OHM, 5%, 0.25W	01121	CB2225
R119	315-0181-00			RES., FXD, CMPSN: 180 OHM, 5%, 0.25W	01121	CB1815
R122	315-0111-00			RES., FXD, CMPSN: 110 OHM, 5%, 0.25W	01121	CB1115
R124	321-0212-00			RES., FXD, FILM: 1.58K OHM, 1%, 0.125W	91637	MFF1816G15800F
R126	321-0190-00			RES., FXD, FILM: 931 OHM, 1%, 0.125W	91637	MFF1816G931R0F
R131	315-0681-00			RES., FXD, CMPSN: 680 OHM, 5%, 0.25W	01121	CB6815
R134	321-0195-00			RES., FXD, FILM: 1.05K OHM, 1%, 0.125W	91637	MFF1816G10500F
R140	321-0356-00			RES., FXD, FILM: 49.9K OHM, 1%, 0.125W	91637	MFF1816G49901F
R141	321-0356-00			RES., FXD, FILM: 49.9K OHM, 1%, 0.125W	91637	MFF1816G49901F
R142	315-0153-00			RES., FXD, CMPSN: 15K OHM, 5%, 0.25W	01121	CB1535
R143	321-0308-00			RES., FXD, FILM: 15.8K OHM, 1%, 0.125W	91637	MFF1816G15801F
R147	308-0304-00			RES., FXD, WW: 1.5K OHM, 1%, 3W	91637	RS2B-B15000F
R152	321-0314-00			RES., FXD, FILM: 18.2K OHM, 1%, 0.125W	91637	MFF1816G18201F
R155	315-0472-00			RES., FXD, CMPSN: 4.7K OHM, 5%, 0.25W	01121	CB4725
R156	315-0103-00			RES., FXD, CMPSN: 10K OHM, 5%, 0.25W	01121	CB1035
R157	315-0472-00			RES., FXD, CMPSN: 4.7K OHM, 5%, 0.25W	01121	CB4725
R160	315-0562-00			RES., FXD, CMPSN: 5.6K OHM, 5%, 0.25W	01121	CB5625

Replaceable Electrical Parts—7A13 (SN B20000 & up)

Ckt No.	Tektronix Part No.	Serial/Model No. Eff	Dscont	Name & Description	Mfr Code	Mfr Part Number
R162	321-0099-00			RES., FXD, FILM: 105 OHM, 1%, 0.125W	91637	MFF1816G105R0F
R163	315-0301-00			RES., FXD, CMPSN: 300 OHM, 5%, 0.25W	01121	CB3015
R164	315-0331-00			RES., FXD, CMPSN: 330 OHM, 5%, 0.25W	01121	CB3315
R166	315-0163-00			RES., FXD, CMPSN: 16K OHM, 5%, 0.25W	01121	CB1635
R167	311-0609-00			RES., VAR, NONWIR: 2K OHM, 10%, 0.50W	73138	82-26-0
R168	315-0202-00			RES., FXD, CMPSN: 2K OHM, 5%, 0.25W	01121	CB2025
R169	315-0200-00			RES., FXD, CMPSN: 20 OHM, 5%, 0.25W	01121	CB2005
R170	315-0300-00			RES., FXD, CMPSN: 30 OHM, 5%, 0.25W	01121	CB3005
R172	315-0203-00			RES., FXD, CMPSN: 20K OHM, 5%, 0.25W	01121	CB2035
R173	311-1232-00			RES., VAR, NONWIR: 50K OHM, 20%, 0.50W	32997	3386F-T04-503
R174	315-0393-00			RES., FXD, CMPSN: 39K OHM, 5%, 0.25W	01121	CB3935
R175	311-0641-00			RES., VAR, NONWIR: 200K OHM, 20%, 0.50W	01121	W7441A
R176	315-0304-00			RES., FXD, CMPSN: 300K OHM, 5%, 0.25W	01121	CB3045
R177	311-1094-00			RES., VAR, NONWIR: 2.5K OHM, 10%, 0.50W (FURNISHED AS A UNIT WITH S35)	01121	GH-7709
R178	321-0077-00			RES., FXD, FILM: 61.9 OHM, 1%, 0.125W	91637	MFF1816G61R90F
R179	315-0221-00			RES., FXD, CMPSN: 220 OHM, 5%, 0.25W	01121	CB2215
R180	315-0752-00			RES., FXD, CMPSN: 7.5K OHM, 5%, 0.25W	01121	CB7525
R181	315-0513-00			RES., FXD, CMPSN: 51K OHM, 5%, 0.25W	01121	CB5135
R182	315-0103-00			RES., FXD, CMPSN: 10K OHM, 5%, 0.25W	01121	CB1035
R183	315-0302-00			RES., FXD, CMPSN: 3K OHM, 5%, 0.25W	01121	CB3025
R184	321-0093-00			RES., FXD, FILM: 90.9 OHM, 1%, 0.125W	91637	MFF1816G90R90F
R185	321-0047-00			RES., FXD, FILM: 30.1 OHM, 1%, 0.125W	91637	MFF1816G30R10F
R186	308-0526-00			RES., FXD, WW: 2.37K OHM, 1%, 3W	91637	RS2B-23700F
R187	311-0605-00			RES., VAR, NONWIR: 200 OHM, 10%, 0.50W	73138	82-23-1
R188	321-0093-00			RES., FXD, FILM: 90.9 OHM, 1%, 0.125W	91637	MFF1816G90R90F
R189	323-0193-00			RES., FXD, FILM: 1K OHM, 1%, 0.50W	75042	CECTO-1001F
R190	321-0150-00			RES., FXD, FILM: 357 OHM, 1%, 0.125W	91637	MFF1816G357R0F
R191A	321-0062-00			RES., FXD, FILM: 43.2 OHM, 1%, 0.125W	91637	MFF1816G43R20F
R191B	321-0049-00			RES., FXD, FILM: 31.6 OHM, 1%, 0.125W	91637	MFF1816G31R60F
R191C	321-0793-03			RES., FXD, FILM: 37.5 OHM, 0.25%, 0.125W	91637	MFF1816D37R50C
R191D	321-0062-00			RES., FXD, FILM: 43.2 OHM, 1%, 0.125W	91637	MFF1816G43R20F
R191E	325-0043-00			RES., FXD, FILM: 22.5 OHM, 0.25%, 0.125W	91637	MFF1816G22R50C
R193	321-0702-00			RES., FXD, FILM: 30 OHM, 0.25%, 0.125W	91637	MFF1816D30R00C
R195	322-0193-00			RES., FXD, FILM: 1K OHM, 1%, 0.25W	75042	CEBTO-1001F
R196	311-1261-00			RES., VAR, NONWIR: 500 OHM, 10%, 0.50W	32997	3329P-L58-501
R197	315-0271-00			RES., FXD, CMPSN: 270 OHM, 5%, 0.25W	01121	CB2715
R199	321-0120-00			RES., FXD, FILM: 174 OHM, 1%, 0.125W	91637	MFF1816G174R0F
R203	315-0104-00			RES., FXD, CMPSN: 100K OHM, 5%, 0.25W	01121	CB1045
R204	323-0318-00			RES., FXD, FILM: 20K OHM, 1%, 0.50W	91637	MFF1226D20001F
R205	315-0221-00			RES., FXD, CMPSN: 220 OHM, 5%, 0.25W	01121	CB2215
R209	323-0304-00			RES., FXD, FILM: 14.3K OHM, 1%, 0.50W	75042	CECTO-1432F
R212	321-0276-00			RES., FXD, FILM: 7.32K OHM, 1%, 0.125W	91637	MFF1816G73200F
R213	315-0750-00			RES., FXD, CMPSN: 75 OHM, 5%, 0.25W	01121	CB7505
R215	315-0101-00			RES., FXD, CMPSN: 100 OHM, 5%, 0.25W	01121	CB1015
R217	315-0222-00			RES., FXD, CMPSN: 2.2K OHM, 5%, 0.25W	01121	CB2225
R219	315-0181-00			RES., FXD, CMPSN: 180 OHM, 5%, 0.25W	01121	CB1815
R222	315-0111-00			RES., FXD, CMPSN: 110 OHM, 5%, 0.25W	01121	CB1115
R224	321-0212-00			RES., FXD, FILM: 1.58K OHM, 1%, 0.125W	91637	MFF1816G15800F
R226	321-0190-00			RES., FXD, FILM: 931 OHM, 1%, 0.125W	91637	MFF1816G931R0F
R231	315-0681-00			RES., FXD, CMPSN: 680 OHM, 5%, 0.25W	01121	CB6815
R234	321-0195-00			RES., FXD, FILM: 1.05K OHM, 1%, 0.125W	91637	MFF1816G10500F
R240	321-0356-00			RES., FXD, FILM: 49.9K OHM, 1%, 0.125W	91637	MFF1816G49901F

Replaceable Electrical Parts—7A13 (SN B20000 & up)

Ckt No.	Tektronix Part No.	Serial/Model No. Eff	Dscont	Name & Description	Mfr Code	Mfr Part Number
R241	321-0356-00			RES., FXD, FILM: 49.9K OHM, 1%, 0.125W	91637	MFF1816G49901F
R242	315-0153-00			RES., FXD, CMPSN: 15K OHM, 5%, 0.25W	01121	CB1535
R243	321-0308-00			RES., FXD, FILM: 15.8K OHM, 1%, 0.125W	91637	MFF1816G15801F
R247	308-0304-00			RES., FXD, WW: 1.5K OHM, 1%, 3W	91637	RS2B-B15000F
R252	321-0314-00			RES., FXD, FILM: 18.2K OHM, 1%, 0.125W	91637	MFF1816G18201F
R254	321-0356-00			RES., FXD, FILM: 49.9K OHM, 1%, 0.125W	91637	MFF1816G49901F
R255	321-0356-00			RES., FXD, FILM: 49.9K OHM, 1%, 0.125W	91637	MFF1816G49901F
R256	315-0103-00			RES., FXD, CMPSN: 10K OHM, 5%, 0.25W	01121	CB1035
R257	315-0243-00			RES., FXD, CMPSN: 24K OHM, 5%, 0.25W	01121	CB2435
R258	315-0153-00			RES., FXD, CMPSN: 15K OHM, 5%, 0.25W	01121	CB1535
R259	308-0496-00			RES., FXD, WW: 1K OHM, 1%, 2.5W	91637	RS2B-A 10000F
R260	315-0562-00			RES., FXD, CMPSN: 5.6K OHM, 5%, 0.25W	01121	CB5625
R262	321-0099-00			RES., FXD, FILM: 105 OHM, 1%, 0.125W	91637	MFF1816G105R0F
R269	315-0200-00			RES., FXD, CMPSN: 20 OHM, 5%, 0.25W	01121	CB2005
R272	315-0203-00			RES., FXD, CMPSN: 20K OHM, 5%, 0.25W	01121	CB2035
R278	321-0077-00			RES., FXD, FILM: 61.9 OHM, 1%, 0.125W	91637	MFF1816G6190F
R279	315-0221-00			RES., FXD, CMPSN: 220 OHM, 5%, 0.25W	01121	CB2215
R280	317-0752-00			RES., FXD, CMPSN: 7.5K OHM, 5%, 0.125W	01121	BB7525
R281	315-0513-00			RES., FXD, CMPSN: 51K OHM, 5%, 0.25W	01121	CB5135
R282	315-0103-00			RES., FXD, CMPSN: 10K OHM, 5%, 0.25W	01121	CB1035
R283	315-0302-00			RES., FXD, CMPSN: 3K OHM, 5%, 0.25W	01121	CB3025
R284	321-0093-00			RES., FXD, FILM: 90.9 OHM, 1%, 0.125W	91637	MFF1816G9090F
R285	321-0047-00			RES., FXD, FILM: 30.1 OHM, 1%, 0.125W	91637	MFF1816G30R10F
R286	308-0526-00			RES., FXD, WW: 2.37K OHM, 1%, 3W	91637	RS2B-23700F
R287	311-0110-00			RES., VAR, NONWIR: 100K OHM, 20%, 0.50W	01121	W4750F
R288	311-1222-00			RES., VAR, NONWIR: 100 OHM, 20%, 0.50W	32997	3386F-T04-101
R289	323-0193-00			RES., FXD, FILM: 1K OHM, 1%, 0.50W	75042	CECT0-1001F
R290	321-0150-00			RES., FXD, FILM: 357 OHM, 1%, 0.125W	91637	MFF1816G357R0F
R291A	321-0062-00			RES., FXD, FILM: 43.2 OHM, 1%, 0.125W	91637	MFF1816G43R20F
R291B	321-0049-00			RES., FXD, FILM: 31.6 OHM, 1%, 0.125W	91637	MFF1816G31R60F
R291C	321-0793-03			RES., FXD, FILM: 37.5 OHM, 0.25%, 0.125W	91637	MFF1816D37R50C
R291D	321-0062-00			RES., FXD, FILM: 43.2 OHM, 1%, 0.125W	91637	MFF1816G43R20F
R291E	325-0043-00			RES., FXD, FILM: 22.5 OHM, 0.25%, 0.125W	91637	MFF1816G22R50C
R295	322-0193-00			RES., FXD, FILM: 1K OHM, 1%, 0.25W	75042	CEBT0-1001F
R296	315-0101-00			RES., FXD, CMPSN: 100 OHM, 5%, 0.25W	01121	CB1015
R297	315-0271-00			RES., FXD, CMPSN: 270 OHM, 5%, 0.25W	01121	CB2715
R299	321-0120-00			RES., FXD, FILM: 174 OHM, 1%, 0.125W	91637	MFF1816G174R0F
R300	315-0111-00			RES., FXD, CMPSN: 110 OHM, 5%, 0.25W	01121	CB1115
R301	321-0041-00			RES., FXD, FILM: 26.1 OHM, 1%, 0.125W	91637	MFF1816G26R10F
R302	321-0182-00			RES., FXD, FILM: 768 OHM, 1%, 0.125W	91637	MFF1816G768R0F
R303	307-0124-00			RES., THERMAL: 5K OHM, 10%	50157	1D1618
R304	315-0241-00			RES., FXD, CMPSN: 240 OHM, 5%, 0.25W	01121	CB2415
R305	322-0215-00			RES., FXD, FILM: 1.69K OHM, 1%, 0.25W	75042	CEBT0-1691F
R306	315-0124-00			RES., FXD, CMPSN: 120K OHM, 5%, 0.25W	01121	CB1245
R307	311-1260-00			RES., VAR, NONWIR: 250 OHM, 10%, 0.50W	32997	3329P-L58-251
R308	315-0683-00			RES., FXD, CMPSN: 68K OHM, 5%, 0.25W	01121	CB6835
R309	311-0350-00			RES., VAR, NONWIR: 500K OHM, 10%, 0.50W	11237	82-40-0
R311	315-0620-00			RES., FXD, CMPSN: 62 OHM, 5%, 0.25W	01121	CB6205
R312	321-0072-00			RES., FXD, FILM: 54.9 OHM, 1%, 0.125W	91637	MFF1816G54R90F
R314	321-0065-00			RES., FXD, FILM: 46.4 OHM, 1%, 0.125W	91637	MFF1816G46R40F
R315	321-0794-03			RES., FXD, FILM: 67.5 OHM, 0.25%, 0.125W	91637	MFF1816D67R50C
R317	325-0042-00			RES., FXD, FILM: 15 OHM, 0.25%, 0.125W	91637	MFF1816G15900300
R320	322-0205-00			RES., FXD, FILM: 1.33K OHM, 1%, 0.25W	91637	MFF1421G13300F

Replaceable Electrical Parts—7A13 (SN B200000 & up)

Ckt No.	Tektronix Part No.	Serial/Model No. Eff	Dscont	Name & Description	Mfr Code	Mfr Part Number
R322	315-0561-00			RES., FXD, CMPSN: 560 OHM, 5%, 0.25W	01121	CB5615
R323	315-0332-00			RES., FXD, CMPSN: 3.3K OHM, 5%, 0.25W	01121	CB3325
R326	317-0471-00			RES., FXD, CMPSN: 470 OHM, 5%, 0.125W	01121	BB4715
R327	321-0097-00			RES., FXD, FILM: 100 OHM, 1%, 0.125W	91637	MFF1816G100ROF
R328	321-0120-00			RES., FXD, FILM: 174 OHM, 1%, 0.125W	91637	MFF1816G174ROF
R329	311-0828-00			RES., VAR, NONWIR: 5K OHM, 10%, 0.50W	01121	WA1N048S502AA
R331	321-0181-00			RES., FXD, FILM: 750 OHM, 1%, 0.125W	91637	MFF1816G750ROF
R332	321-0055-00			RES., FXD, FILM: 36.5 OHM, 1%, 0.125W	91637	MFF1816G36R50F
R333	311-0605-00			RES., VAR, NONWIR: 200 OHM, 10%, 0.50W	73138	82-23-1
R334	315-0512-00			RES., FXD, CMPSN: 5.1K OHM, 5%, 0.25W	01121	CB5125
R335	311-0607-00			RES., VAR, NONWIR: 10K OHM, 10%, 0.50W	73138	82P-59-4-103K
R336	311-0635-00			RES., VAR, NONWIR: 1K OHM, 10%, 0.50W	73138	82-32-0
R337	315-0391-00			RES., FXD, CMPSN: 390 OHM, 5%, 0.25W	01121	CB3915
R340	321-0088-00			RES., FXD, FILM: 80.6 OHM, 1%, 0.125W	91637	MFF1816G80R60F
R344	315-0101-00			RES., FXD, CMPSN: 100 OHM, 5%, 0.25W	01121	CB1015
R350	321-0039-00			RES., FXD, FILM: 24.9 OHM, 1%, 0.125W	91637	MFF1816G24R90F
R351	321-0168-00			RES., FXD, FILM: 549 OHM, 1%, 0.125W	91637	MFF1816G549ROF
R354	315-0181-00			RES., FXD, CMPSN: 180 OHM, 5%, 0.25W	01121	CB1815
R357	315-0132-00			RES., FXD, CMPSN: 1.3K OHM, 5%, 0.25W	01121	CB1325
R360	311-0643-00			RES., VAR, NONWIR: 50 OHM, 10%, 0.50W	73138	82-33-2
R362	321-0147-00			RES., FXD, FILM: 332 OHM, 1%, 0.125W	91637	MFF1816G332ROF
R368	315-0272-00			RES., FXD, CMPSN: 2.7K OHM, 5%, 0.25W	01121	CB2725
R370	315-0150-00			RES., FXD, CMPSN: 15 OHM, 5%, 0.25W	01121	CB1505
R371	311-0605-00			RES., VAR, NONWIR: 200 OHM, 10%, 0.50W	73138	82-23-1
R372	321-0024-00			RES., FXD, FILM: 17.4 OHM, 1%, 0.125W	91637	MFF1816G17R40F
R373	321-0153-00			RES., FXD, FILM: 383 OHM, 1%, 0.125W	91637	MFF1816G383ROF
R374	315-0301-00			RES., FXD, CMPSN: 300 OHM, 5%, 0.25W	01121	CB3015
R375	315-0181-00			RES., FXD, CMPSN: 180 OHM, 5%, 0.25W	01121	CB1815
R376	315-0153-00			RES., FXD, CMPSN: 15K OHM, 5%, 0.25W	01121	CB1535
R377	315-0132-00			RES., FXD, CMPSN: 1.3K OHM, 5%, 0.25W	01121	CB1325
R378	315-0272-00			RES., FXD, CMPSN: 2.7K OHM, 5%, 0.25W	01121	CB2725
R380	311-0643-00			RES., VAR, NONWIR: 50 OHM, 10%, 0.50W	73138	82-33-2
R382	321-0147-00			RES., FXD, FILM: 332 OHM, 1%, 0.125W	91637	MFF1816G332ROF
R383	321-0105-00			RES., FXD, FILM: 121 OHM, 1%, 0.125W	91637	MFF1816G121ROF
R401	321-0041-00			RES., FXD, FILM: 26.1 OHM, 1%, 0.125W	91637	MFF1816G26R10F
R402	321-0182-00			RES., FXD, FILM: 768 OHM, 1%, 0.125W	91637	MFF1816G768ROF
R404	315-0241-00			RES., FXD, CMPSN: 240 OHM, 5%, 0.25W	01121	CB2415
R407	322-0212-00			RES., FXD, FILM: 1.58K OHM, 1%, 0.25W	75042	CEBT0-1581F
R408	315-0683-00			RES., FXD, CMPSN: 68K OHM, 5%, 0.25W	01121	CB6835
R411	315-0620-00			RES., FXD, CMPSN: 62 OHM, 5%, 0.25W	01121	CB6205
R412	321-0072-00			RES., FXD, FILM: 54.9 OHM, 1%, 0.125W	91637	MFF1816G54R90F
R414	321-0065-00			RES., FXD, FILM: 46.4 OHM, 1%, 0.125W	91637	MFF1816G46R40F
R415	321-0794-03			RES., FXD, FILM: 67.5 OHM, 0.25%, 0.125W	91637	MFF1816D67R50C
R420	322-0205-00			RES., FXD, FILM: 1.33K OHM, 1%, 0.25W	91637	MFF1421G13300F
R426	315-0471-00			RES., FXD, CMPSN: 470 OHM, 5%, 0.25W	01121	CB4715
R427	321-0097-00			RES., FXD, FILM: 100 OHM, 1%, 0.125W	91637	MFF1816G100ROF
R428	321-0120-00			RES., FXD, FILM: 174 OHM, 1%, 0.125W	91637	MFF1816G174ROF
R431	321-0181-00			RES., FXD, FILM: 750 OHM, 1%, 0.125W	91637	MFF1816G750ROF
R432	311-0609-00			RES., VAR, NONWIR: 2K OHM, 10%, 0.50W	73138	82-26-0
R434	315-0302-00			RES., FXD, CMPSN: 3K OHM, 5%, 0.25W	01121	CB3025
R435	311-0880-01			RES., VAR, NONWIR: 5K OHM, 20%, 0.50W (FURNISHED AS A UNIT WITH S40)	71590	BA202-001
R437	315-0391-00			RES., FXD, CMPSN: 390 OHM, 5%, 0.25W	01121	CB3915

Replaceable Electrical Parts—7A13 (SN B200000 & up)

Ckt No.	Tektronix Part No.	Serial/Model No. Eff	Dscont	Name & Description	Mfr Code	Mfr Part Number
R439	315-0121-00			RES., FXD, CMPSN: 120 OHM, 5%, 0.25W	01121	CB1215
R440	321-0088-00			RES., FXD, FILM: 80.6 OHM, 1%, 0.125W	91637	MFF1816G80R60F
R451	321-0168-00			RES., FXD, FILM: 549 OHM, 1%, 0.125W	91637	MFF1816G549R0F
R454	315-0181-00			RES., FXD, CMPSN: 180 OHM, 5%, 0.25W	01121	CB1815
R456	315-0150-00			RES., FXD, CMPSN: 15 OHM, 5%, 0.25W	01121	CB1505
R462	321-0147-00			RES., FXD, FILM: 332 OHM, 1%, 0.125W	91637	MFF1816G332R0F
R463	321-0105-00			RES., FXD, FILM: 121 OHM, 1%, 0.125W	91637	MFF1816G121R0F
R470	315-0150-00			RES., FXD, CMPSN: 15 OHM, 5%, 0.25W	01121	CB1505
R472	315-0560-00			RES., FXD, CMPSN: 56 OHM, 5%, 0.25W	01121	CB5605
R473	321-0153-00			RES., FXD, FILM: 383 OHM, 1%, 0.125W	91637	MFF1816G383R0F
R475	315-0181-00			RES., FXD, CMPSN: 180 OHM, 5%, 0.25W	01121	CB1815
R477	307-0106-00			RES., FXD, CMPSN: 4.7 OHM, 5%, 0.25W	01121	CB47G5
R482	321-0147-00			RES., FXD, FILM: 332 OHM, 1%, 0.125W	91637	MFF1816G332R0F
R501	321-0327-00			RES., FXD, FILM: 24.9K OHM, 1%, 0.125W	91637	MFF1816G24901F
R502	321-0327-00			RES., FXD, FILM: 24.9K OHM, 1%, 0.125W	91637	MFF1816G24901F
R503	315-0822-00			RES., FXD, CMPSN: 8.2K OHM, 5%, 0.25W	01121	CB8225
R505	303-0301-00			RES., FXD, CMPSN: 300 OHM, 5%, 1W	01121	GB3015
R521	321-0212-00			RES., FXD, FILM: 1.58K OHM, 1%, 0.125W	91637	MFF1816G15800F
R522	321-0226-00			RES., FXD, FILM: 2.21K OHM, 1%, 0.125W	91637	MFF1816G22100F
R523	315-0241-00			RES., FXD, CMPSN: 240 OHM, 5%, 0.25W	01121	CB2415
R525	315-0681-00			RES., FXD, CMPSN: 680 OHM, 5%, 0.25W	01121	CB6815
R528	321-0143-00			RES., FXD, FILM: 301 OHM, 1%, 0.125W	91637	MFF1816G301R0F
R531	321-0226-00			RES., FXD, FILM: 2.21K OHM, 1%, 0.125W	91637	MFF1816G22100F
R532	321-0212-00			RES., FXD, FILM: 1.58K OHM, 1%, 0.125W	91637	MFF1816G15800F
R533	315-0241-00			RES., FXD, CMPSN: 240 OHM, 5%, 0.25W	01121	CB2415
R535	301-0241-00			RES., FXD, CMPSN: 240 OHM, 5%, 0.50W	01121	EB2415
R563	308-0433-00			RES., FXD, WW: 1 OHM, 10%, 0.25W	80009	308-0433-00
R565	315-0510-00			RES., FXD, CMPSN: 51 OHM, 5%, 0.25W	01121	CB5105
R602	321-0066-00			RES., FXD, FILM: 47.5 OHM, 1%, 0.125W	91637	MFF1816G47R50F
R603	321-0193-00			RES., FXD, FILM: 1K OHM, 1%, 0.125W	91637	MFF1816G10000F
R605	315-0122-00			RES., FXD, CMPSN: 1.2K OHM, 5%, 0.25W	01121	CB1225
R607	315-0472-00			RES., FXD, CMPSN: 4.7K OHM, 5%, 0.25W	01121	CB4725
R609	308-0141-00			RES., FXD, WW: 1 OHM, 5%, 0.5W	80009	308-0141-00
R610	301-0120-00			RES., FXD, CMPSN: 12 OHM, 5%, 0.50W	01121	EB1205
R617	315-0200-00			RES., FXD, CMPSN: 20 OHM, 5%, 0.25W	01121	CB2005
R620	315-0183-00			RES., FXD, CMPSN: 18K OHM, 5%, 0.25W	01121	CB1835
R621	315-0363-00			RES., FXD, CMPSN: 36K OHM, 5%, 0.25W	01121	CB3635
R623	321-0230-00			RES., FXD, FILM: 2.43K OHM, 1%, 0.125W	91637	MFF1816G24300F
R624	315-0913-00			RES., FXD, CMPSN: 91K OHM, 5%, 0.25W	01121	CB9135
R626	315-0163-00			RES., FXD, CMPSN: 16K OHM, 5%, 0.25W	01121	CB1635
R628	315-0163-00			RES., FXD, CMPSN: 16K OHM, 5%, 0.25W	01121	CB1635
R630	315-0223-00			RES., FXD, CMPSN: 22K OHM, 5%, 0.25W	01121	CB2235
R631	315-0393-00			RES., FXD, CMPSN: 39K OHM, 5%, 0.25W	01121	CB3935
R632	315-0200-00			RES., FXD, CMPSN: 20 OHM, 5%, 0.25W	01121	CB2005
R636	315-0103-00			RES., FXD, CMPSN: 10K OHM, 5%, 0.25W	01121	CB1035
R639	315-0103-00			RES., FXD, CMPSN: 10K OHM, 5%, 0.25W	01121	CB1035
R641	315-0102-00			RES., FXD, CMPSN: 1K OHM, 5%, 0.25W	01121	CB1025
R643	315-0103-00			RES., FXD, CMPSN: 10K OHM, 5%, 0.25W	01121	CB1035
R645	315-0102-00			RES., FXD, CMPSN: 1K OHM, 5%, 0.25W	01121	CB1025
R647	315-0103-00			RES., FXD, CMPSN: 10K OHM, 5%, 0.25W	01121	CB1035
R649	315-0102-00			RES., FXD, CMPSN: 1K OHM, 5%, 0.25W	01121	CB1025
R651	315-0103-00			RES., FXD, CMPSN: 10K OHM, 5%, 0.25W	01121	CB1035
R653	315-0103-00			RES., FXD, CMPSN: 10K OHM, 5%, 0.25W	01121	CB1035

Replaceable Electrical Parts—7A13 (SN B200000 & up)

Ckt No.	Tektronix Part No.	Serial/Model No. Eff	Dscont	Name & Description	Mfr Code	Mfr Part Number
R655	315-0103-00			RES., FXD, CMPSN: 10K OHM, 5%, 0.25W	01121	CB1035
R657	315-0103-00			RES., FXD, CMPSN: 10K OHM, 5%, 0.25W	01121	CB1035
R659	315-0182-00			RES., FXD, CMPSN: 1.8K OHM, 5%, 0.25W	01121	CB1825
R661	315-0161-00			RES., FXD, CMPSN: 160 OHM, 5%, 0.25W	01121	CB1615
R670	315-0273-00			RES., FXD, CMPSN: 27K OHM, 5%, 0.25W	01121	CB2735
R671	315-0273-00			RES., FXD, CMPSN: 27K OHM, 5%, 0.25W	01121	CB2735
R673	315-0132-00			RES., FXD, CMPSN: 1.3K OHM, 5%, 0.25W	01121	CB1325
R674	315-0272-00			RES., FXD, CMPSN: 2.7K OHM, 5%, 0.25W	01121	CB2725
R675	315-0333-00			RES., FXD, CMPSN: 33K OHM, 5%, 0.25W	01121	CB3335
R678	321-0160-00			RES., FXD, FILM: 453 OHM, 1%, 0.125W	91637	MFF1816G453ROF
R679	321-0332-07			RES., FXD, FILM: 28K OHM, 0.1%, 0.125W	91637	MFF1816C28001B
R681	321-0332-07			RES., FXD, FILM: 28K OHM, 0.1%, 0.125W	91637	MFF1816C28001B
R683	321-0184-00			RES., FXD, FILM: 806 OHM, 1%, 0.125W	91637	MFF1816G806ROF
R685	321-0206-00			RES., FXD, FILM: 1.37K OHM, 1%, 0.125W	91637	MFF1816G13700F
R686	311-1340-00			RES., VAR, NONWIR: 1K OHM, 10%, 0.50W	02111	43P102T621
R687	321-0278-00			RES., FXD, FILM: 7.68K OHM, 1%, 0.125W	91637	MFF1816G76800F
R690A	311-1057-00			RES., VAR, NONWIR: 5K OHM, 3%, 0.01%	80294	3540S-420-502
R690B	311-0887-00			RES., VAR, NONWIR: 50K OHM, 10%, 0.50W	80009	311-0887-00
R692	315-0914-00			RES., FXD, CMPSN: 910K OHM, 5%, 0.25W	01121	CB9145
R693	321-0222-00			RES., FXD, FILM: 2K OHM, 1%, 0.125W	91637	MFF1816G20000F
R696	311-1272-00			RES., VAR, NONWIR: 100K OHM, 10%, 0.50W	32997	3329P-L58-104
R698	315-0205-00			RES., FXD, CMPSN: 2M OHM, 5%, 0.25W	01121	CB2055
R699	321-0644-00			RES., FXD, FILM: 100K OHM, 0.25%, 0.125W	91637	MFF1816C10002C
R701	315-0101-00			RES., FXD, CMPSN: 100 OHM, 5%, 0.25W	01121	CB1015
R703	321-0332-07			RES., FXD, FILM: 28K OHM, 0.1%, 0.125W	91637	MFF1816C28001B
R705	321-0331-09			RES., FXD, FILM: 27.4K OHM, 1%, 0.125W	91637	MFF1816C27401F
R708	311-1272-00			RES., VAR, NONWIR: 100K OHM, 10%, 0.50W	32997	3329P-L58-104
R710	315-0104-00			RES., FXD, CMPSN: 100K OHM, 5%, 0.25W	01121	CB1045
R711	315-0131-00			RES., FXD, CMPSN: 130 OHM, 5%, 0.25W	01121	CB1315
R712	315-0104-00			RES., FXD, CMPSN: 100K OHM, 5%, 0.25W	01121	CB1045
R714	315-0152-00			RES., FXD, CMPSN: 1.5K OHM, 5%, 0.25W	01121	CB1525
R716	315-0202-00			RES., FXD, CMPSN: 2K OHM, 5%, 0.25W	01121	CB2025
R718	315-0512-00			RES., FXD, CMPSN: 5.1K OHM, 5%, 0.25W	01121	CB5125
R720	311-1272-00			RES., VAR, NONWIR: 100K OHM, 10%, 0.50W	32997	3329P-L58-104
R722	315-0104-00			RES., FXD, CMPSN: 100K OHM, 5%, 0.25W	01121	CB1045
R723	315-0470-00			RES., FXD, CMPSN: 47 OHM, 5%, 0.25W	01121	CB4705
R724	315-0153-00			RES., FXD, CMPSN: 15K OHM, 5%, 0.25W	01121	CB1535
R726	321-0332-07			RES., FXD, FILM: 28K OHM, 0.1%, 0.125W	91637	MFF1816C28001B
R727	311-1259-00			RES., VAR, NONWIR: 100 OHM, 10%, 0.50W	32997	3329P-L58-101
R729	321-0332-07			RES., FXD, FILM: 28K OHM, 0.1%, 0.125W	91637	MFF1816C28001B
R741	315-0102-00			RES., FXD, CMPSN: 1K OHM, 5%, 0.25W	01121	CB1025
R742	315-0102-00			RES., FXD, CMPSN: 1K OHM, 5%, 0.25W	01121	CB1025
R744	315-0102-00	B200000	B236984	RES., FXD, CMPSN: 1K OHM, 5%, 0.25W	01121	CB1025
R744	321-0197-00	B236985		RES., FXD, FILM: 1.1K OHM, 1%, 0.125W	91637	MFF1816G11000F
R753	315-0103-00			RES., FXD, CMPSN: 10K OHM, 5%, 0.25W	01121	CB1035
S1	670-1043-02	B200000	B209999	CKT BOARD ASSY: PUSH BUTTON, +AC-GND-DC (SEE MPL FOR REPLACEMENT PARTS)	80009	670-1043-02
S1	670-1043-03	B210000		CKT BOARD ASSY: PUSH BUTTON, +AC-GND-DC (SEE MPL FOR REPLACEMENT PARTS)	80009	670-1043-03
S10	670-1043-02	B200000	B209999	CKT BOARD ASSY: PLUG-IN, ATTENUATOR (SEE MPL FOR REPLACEMENT PARTS)	80009	670-1043-02
S10	670-1043-03	B210000		CKT BOARD ASSY: PLUG-IN, ATTENUATOR (SEE MPL FOR REPLACEMENT PARTS)	80009	670-1043-03

Replaceable Electrical Parts—7A13 (SN B200000 & up)

Ckt No.	Tektronix Part No.	Serial/Model No. Eff	Dscont	Name & Description	Mfr Code	Mfr Part Number
S21	670-1043-02 -----	B200000	B209999	CKT BOARD ASSY:PUSH BUTTON,-AC-GND-DC (SEE MPL FOR REPLACEMENT PARTS)	80009	670-1043-02
S21	670-1043-03 -----	B210000		CKT BOARD ASSY:PUSH BUTTON,-AC-GND-DC (SEE MPL FOR REPLACEMENT PARTS)	80009	670-1043-03
S35	311-1094-00 -----			RES.,VAR, NONWIR:2.5K OHM,10%,0.50W (FURNISHED AS A UNIT WITH R177)	01121	GH-7709
S40	311-0880-01 -----			RES.,VAR, NONWIR:5K OHM,20%,0.50W (FURNISHED AS A UNIT R435)	71590	BA202-001
S50	260-1033-00			SWITCH,ROTARY:	80009	260-1033-00
S80	260-0816-00			SWITCH,SLIDE:DPDT,0.5A,125VAC	79727	GF-126-0012A
S490	670-1073-02 -----			CKT BOARD ASSY:PUSH BUTTON,BW (SEE MPL FOR REPLACEMENT PARTS)	80009	670-1073-02
S570	670-1042-02 -----			CKT BOARD ASSY:PUSH BUTTON,VC POLARITY (SEE MPL FOR REPLACEMENT PARTS)	80009	670-1042-02
T185	120-0482-00			XFMR,TOROID:2 TURNS,BIFILAR	80009	120-0482-00
T350	120-0482-00			XFMR,TOROID:2 TURNS,BIFILAR	80009	120-0482-00
U632A,B	156-0388-00			MICROCIRCUIT,DI:DUAL D-TYPE FLIP-FLOP	80009	156-0388-00
U635	156-0306-00			MICROCIRCUIT,DI:4.5 DECADE COUNTER	07263	A7R381R19X
U665	150-1012-01	B200000	B225504	LAMP,LED:W/FRAME AND FILTER	80009	150-1012-01
U665	150-1012-03	B225505		LAMP,LED,RDOUT:W/FRAME AND FILTER	80009	150-1012-03
U668	156-0493-00			MICROCIRCUIT,DI:BCD TO 7 SEG DEC/DRIVER	07263	9368DC
U678A,B	156-0495-00			MICROCIRCUIT,LI:OPNL AMPL	80009	156-0495-00
U678C,D						
VR103	152-0394-00			SEMICONV DEVICE:ZENER,1W,47V,5%	81483	1N3036B
VR155	152-0395-00			SEMICONV DEVICE:ZENER,0.4W,4.3V,5%	04713	1N749A
VR157	152-0395-00			SEMICONV DEVICE:ZENER,0.4W,4.3V,5%	04713	1N749A
VR166	152-0395-00			SEMICONV DEVICE:ZENER,0.4W,4.3V,5%	04713	1N749A
VR203	152-0394-00			SEMICONV DEVICE:ZENER,1W,47V,5%	81483	1N3036B
VR634	152-0278-00			SEMICONV DEVICE:ZENER,0.4W,3V,5%	80009	152-0278-00
VR683	152-0411-00			SEMICONV DEVICE:ZENER,0.25W,9V,5%	04713	1N937

DIAGRAMS AND CIRCUIT BOARD ILLUSTRATIONS

Symbols and Reference Designators

Electrical components shown on the diagrams are in the following units unless noted otherwise:

- Capacitors = Values one or greater are in picofarads (pF).
Values less than one are in microfarads (μF).
- Resistors = Ohms (Ω).

Symbols used on the diagrams are based on ANSI Standard Y32.2-1970.

Logic symbology is based on ANSI Y32.14-1973 in terms of positive logic. Logic symbols depict the logic function performed and may differ from the manufacturer's data.

The following prefix letters are used as reference designators to identify components or assemblies on the diagrams.

<p>A Assembly, separable or repairable (circuit board, etc.)</p> <p>AT Attenuator, fixed or variable</p> <p>B Motor</p> <p>BT Battery</p> <p>C Capacitor, fixed or variable</p> <p>CB Circuit breaker</p> <p>CR Diode, signal or rectifier</p> <p>DL Delay line</p> <p>DS Indicating device (lamp)</p> <p>E Spark Gap</p> <p>F Fuse</p> <p>FL Filter</p>	<p>H Heat dissipating device (heat sink, heat radiator, etc.)</p> <p>HR Heater</p> <p>HY Hybrid circuit</p> <p>J Connector, stationary portion</p> <p>K Relay</p> <p>L Inductor, fixed or variable</p> <p>LR Inductor/resistor combination</p> <p>M Meter</p> <p>P Connector, movable portion</p> <p>Q Transistor or silicon-controlled rectifier</p> <p>R Resistor, fixed or variable</p>	<p>RT Thermistor</p> <p>S Switch</p> <p>T Transformer</p> <p>TC Thermocouple</p> <p>TP Test point</p> <p>U Assembly, inseparable or non-repairable (integrated circuit, etc.)</p> <p>V Electron tube</p> <p>VR Voltage regulator (zener diode, etc.)</p> <p>Y Crystal</p> <p>Z Phase shifter</p>
--	---	--

The following special symbols are used on the diagrams:

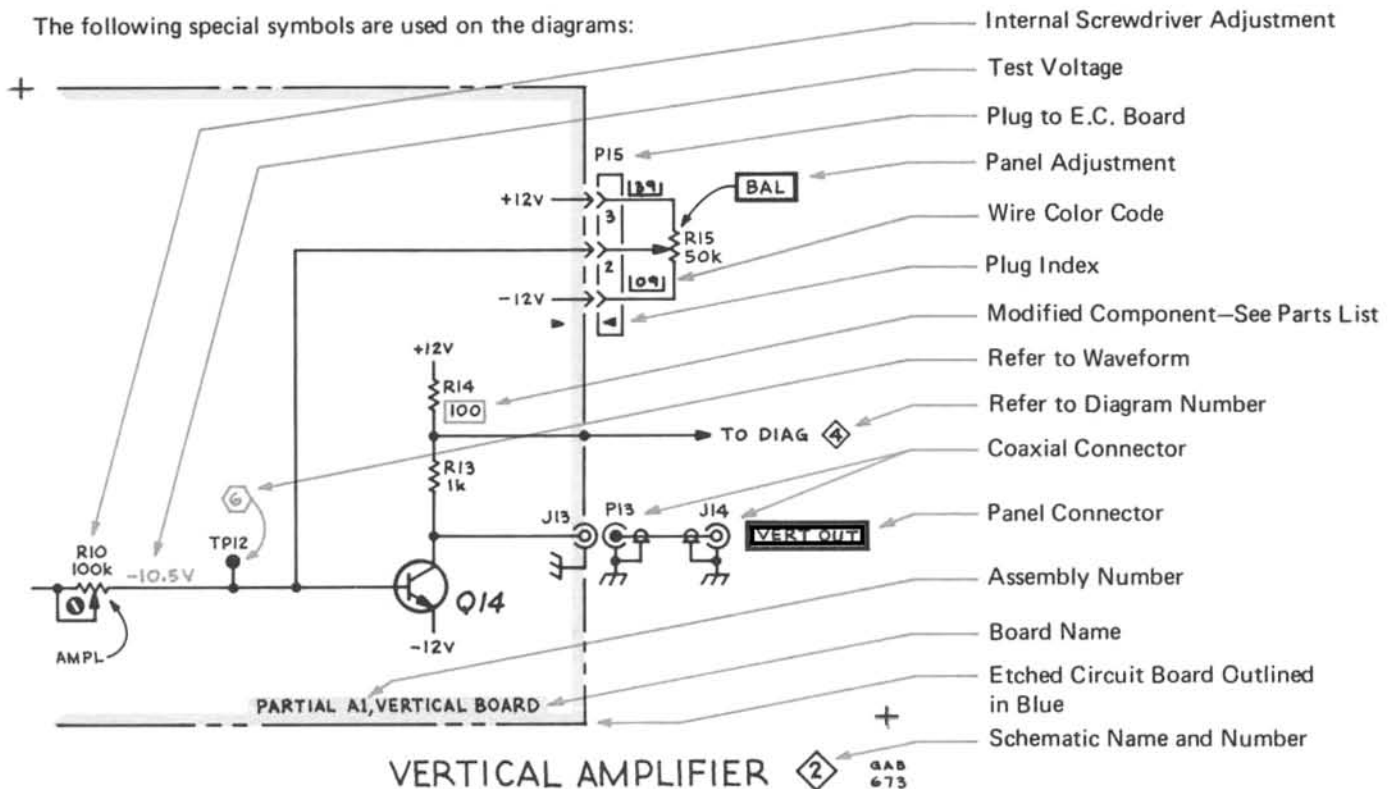

7A13 VOLTAGES and WAVEFORM CONDITIONS

DC circuit voltages were measured with a digital multimeter having an accuracy of 0.1%; input impedance is greater than 1 kM Ω on the 1.500 volt range and 10 M Ω on the higher ranges. All voltages were measured with respect to chassis ground unless noted otherwise.

Waveforms shown are actual photographs taken with a Tektronix Oscilloscope Camera System. Test oscilloscope* deflection factor and sweep rate conditions are noted on each waveform. AC coupling was used to obtain photographs of the waveform amplitudes. The test oscilloscope was externally triggered by the 4 V calibrator signal that was applied from the Indicator oscilloscope* to the 7A13 +INPUT. External triggering enables the waveform polarity to be shown with respect to the input signal.

The test oscilloscope used for obtaining the waveform photographs had the following minimum characteristics: Deflection factor, 50 mV/div to 5 V/div (with a 10X probe); AC coupled input; frequency response, 2 Hz to 10 MHz; sweep rate, 0.2 ms/div.

7A13 Control Settings

COMPARISON VOLTAGE (V _C)	
Polarity	Pushbuttons released
Selector	As is
FINE	As is
+INPUT Mode	AC (for waveforms)
	GND (for voltages)
–INPUT Mode	GND
VOLTS/DIV	1 V
VARIABLE (VOLTS/DIV)	CAL (CW, in detent)
PULL VAR FOR X10 V _C RANGE	Pushed in
VAR BAL	As is
BW	5 MHz
POSITION	For centered trace or display
R _{in} (see Fig. 2-1, Operating Instructions)	R _{in} = 1 M Ω

*The test oscilloscope is used for signal tracing and obtaining waveform photographs. The indicator oscilloscope is the oscilloscope that accepts the 7A13 Plug-In Unit.

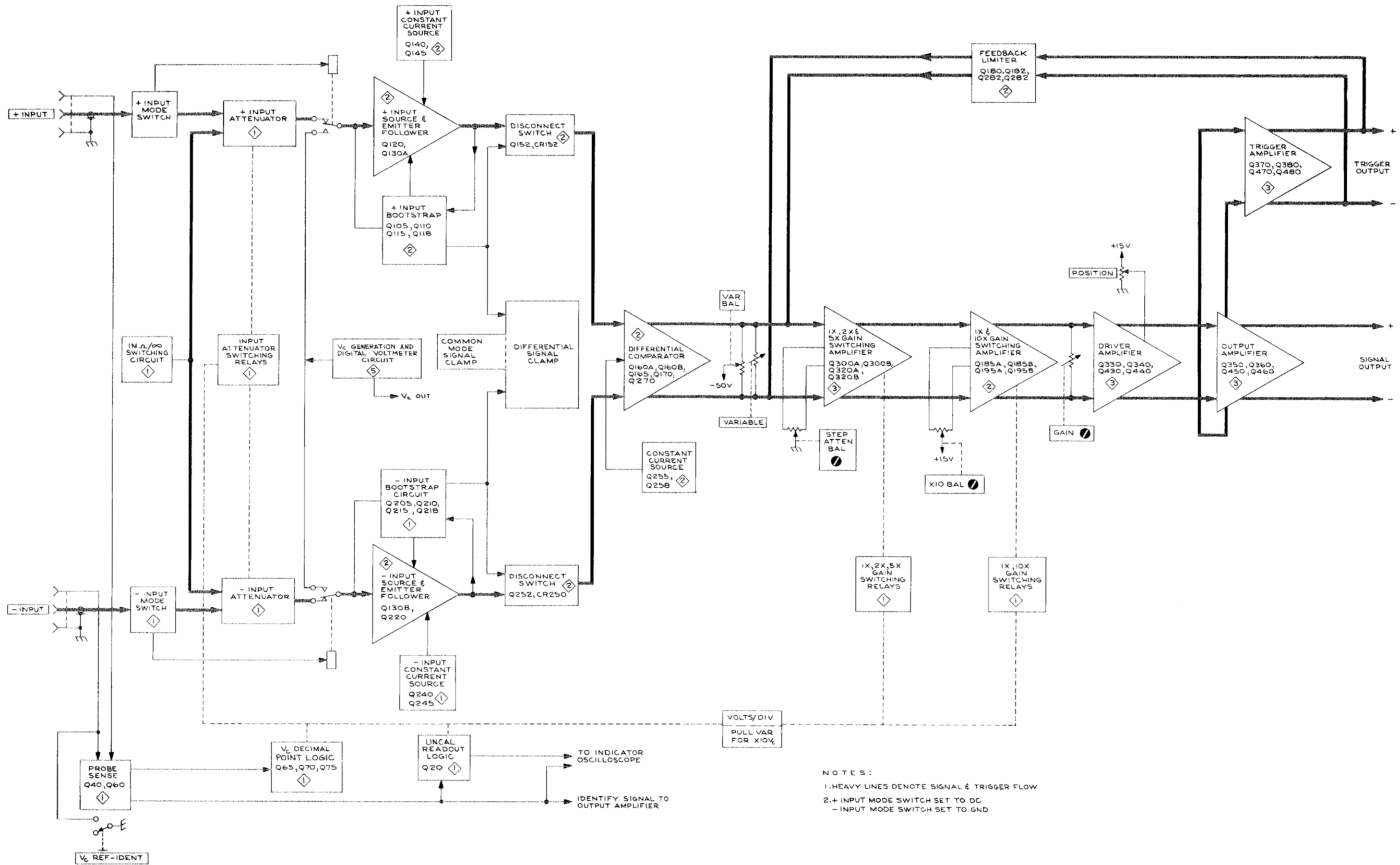

- NOTES:
1. HEAVY LINES DENOTE SIGNAL & TRIGGER FLOW
 2. + INPUT MODE SWITCH SET TO DC
 - INPUT MODE SWITCH SET TO GND

CR10 located on back
of board SN B060000

CR30 located on back
of board SN B060000

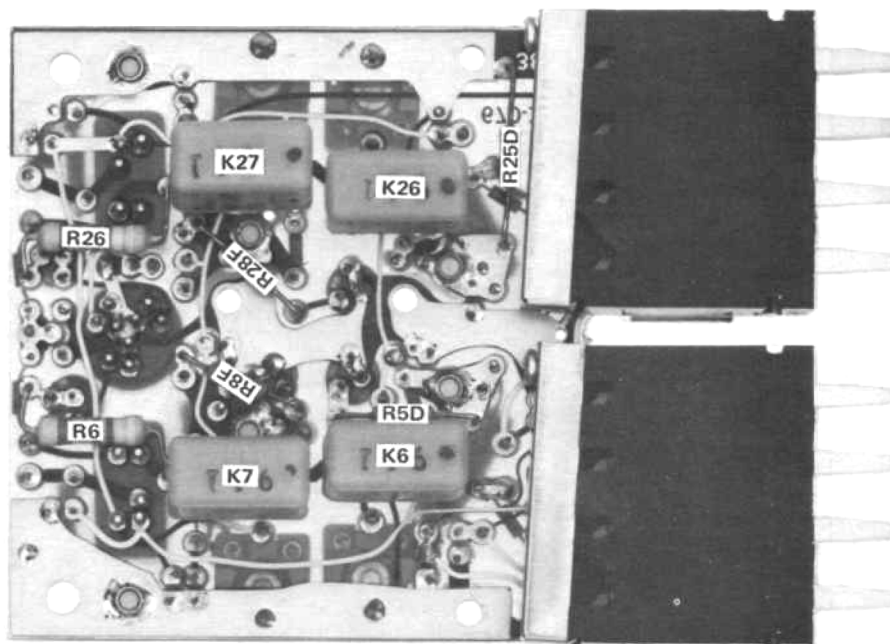
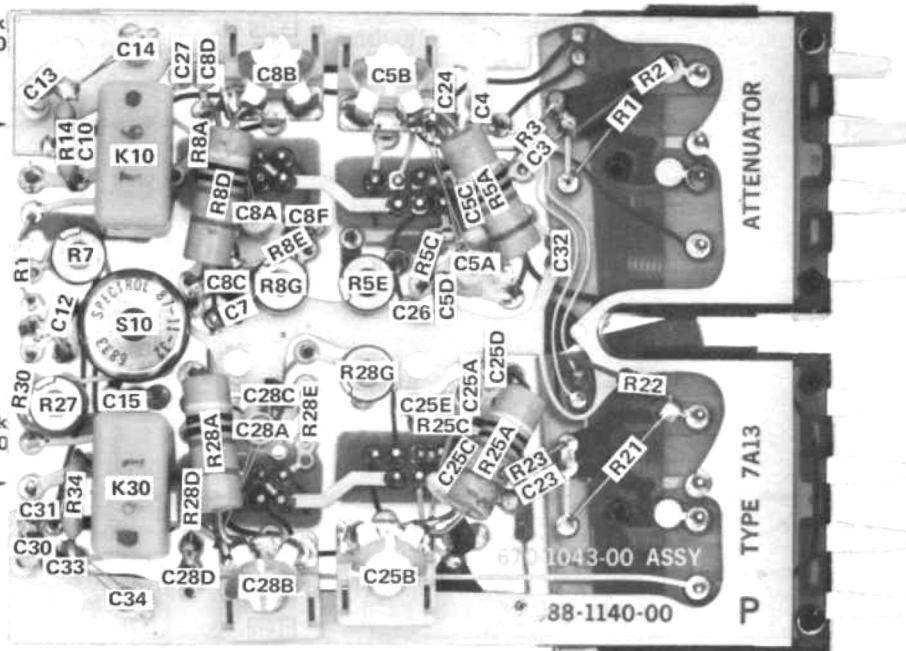
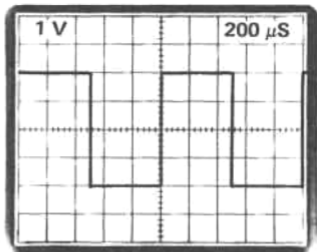
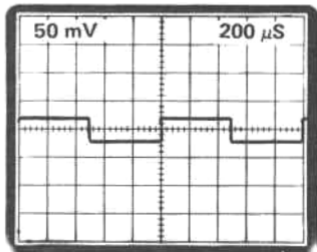

Fig. 7-1. Attenuator board showing component locations.

1



2



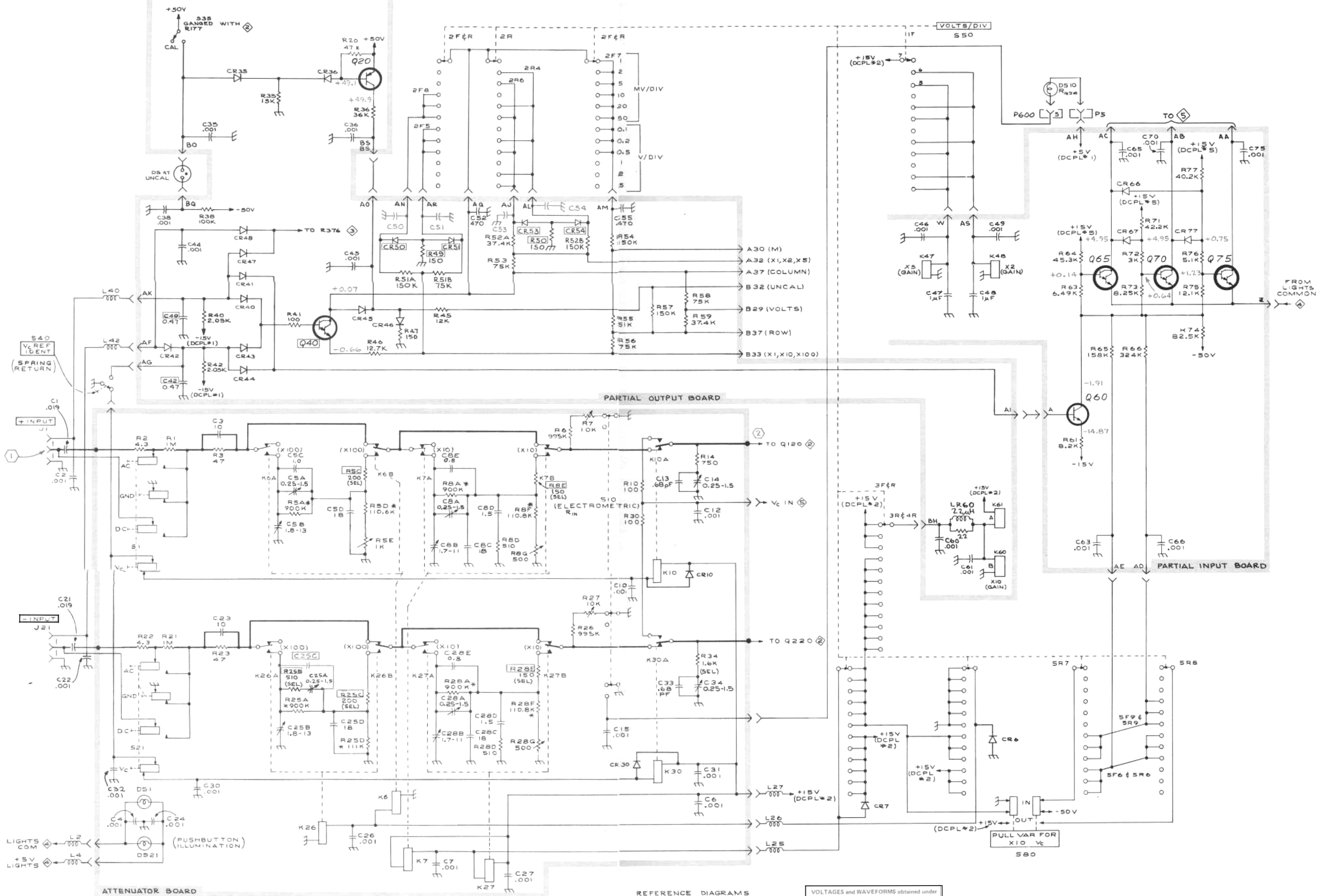

SEE PARTS LIST FOR EARLIER VALUES AND SERIAL NUMBER RANGES OF PARTS OUTLINED OR DEPICTED IN BLUE.

NOTE:
 1. SEE PARTS LIST FOR SEMICONDUCTOR TYPES
 2. *MATCHED COMPONENTS
 3. HEAVY LINES DENOTE SIGNAL FLOW

REFERENCE DIAGRAMS
 ⊕ INPUT AMPLIFIER
 ⊕ OUTPUT AMPLIFIER
 ⊕ DISTRIBUTION DIAGRAM
 ⊕ COMPARISION VOLTAGE GENERATOR

VOLTAGES and WAVEFORMS obtained under conditions given on page 7-2.

Copyright 1969,
TEKTRONIX, INC.

TYPE 7A13
INPUT
670-1046-01 ASSY

PB

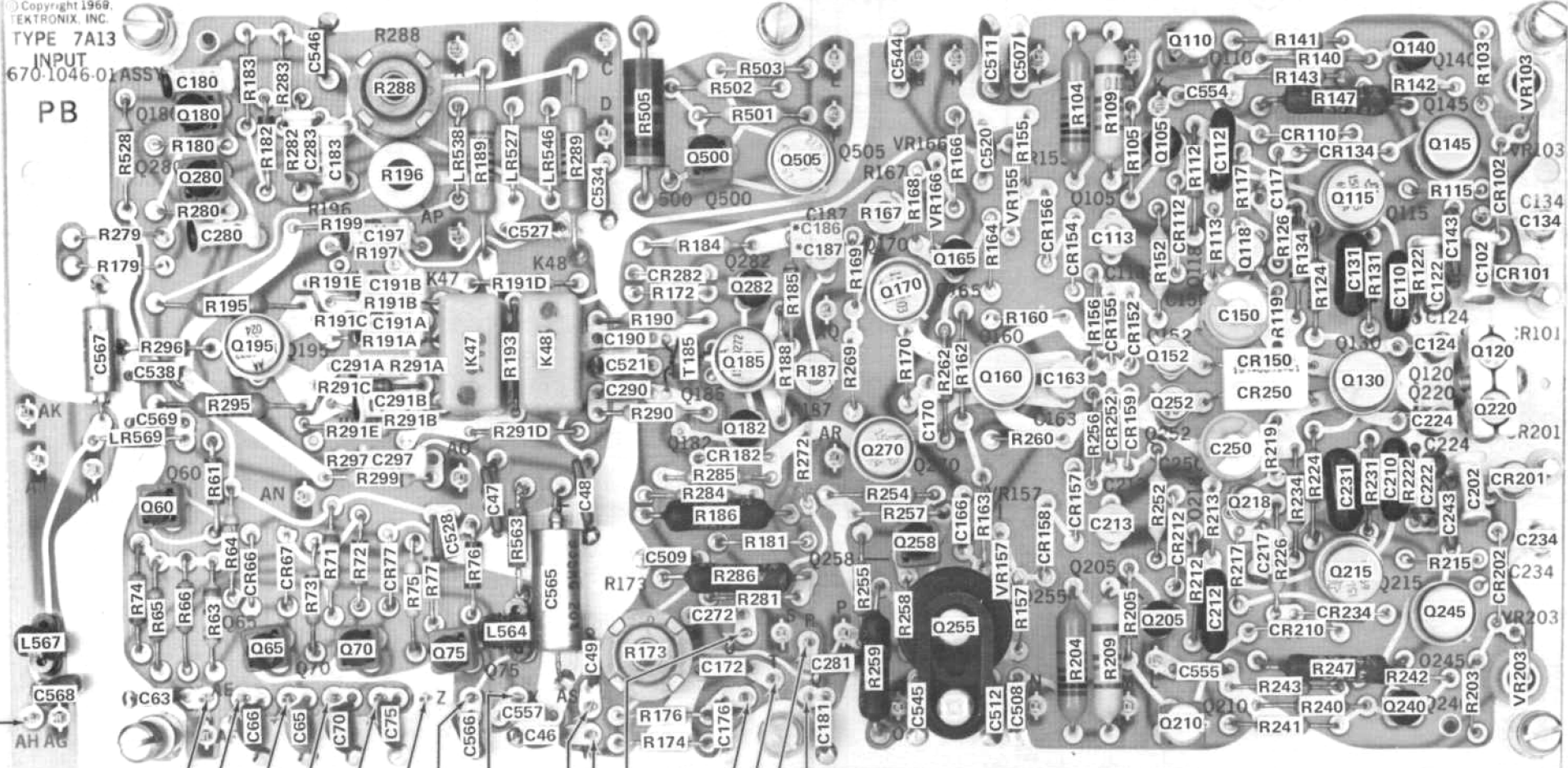

'AH' red on blk

'AE' vio on wht

'AD' yel-blk on wht

'AC' brn on wht

'AB' red on wht

'AA' blu-blk on wht

'Z' blk on wht

'Y' brn
'X' red-brn on vio

'U' gry on wht

'W' red-blk on wht

'AS' yel on wht

'Q' orn on wht

'R' blu on wht

'T' red on wht

'V' yel on wht

*See Parts List for
serial number ranges.

Fig. 7-2. Input Amplifier circuit board showing component locations and wire color code.

1

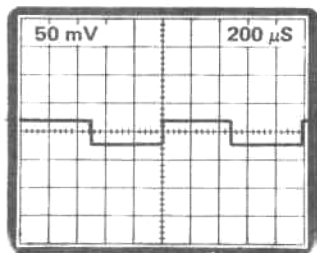

2

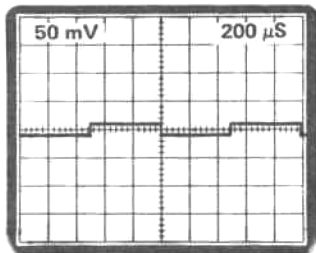

3

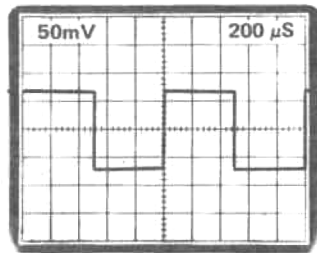

4

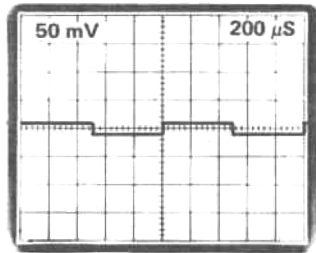

5

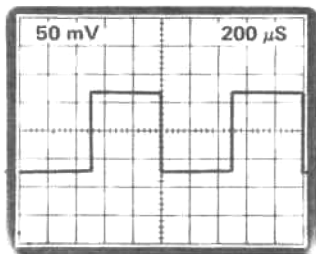

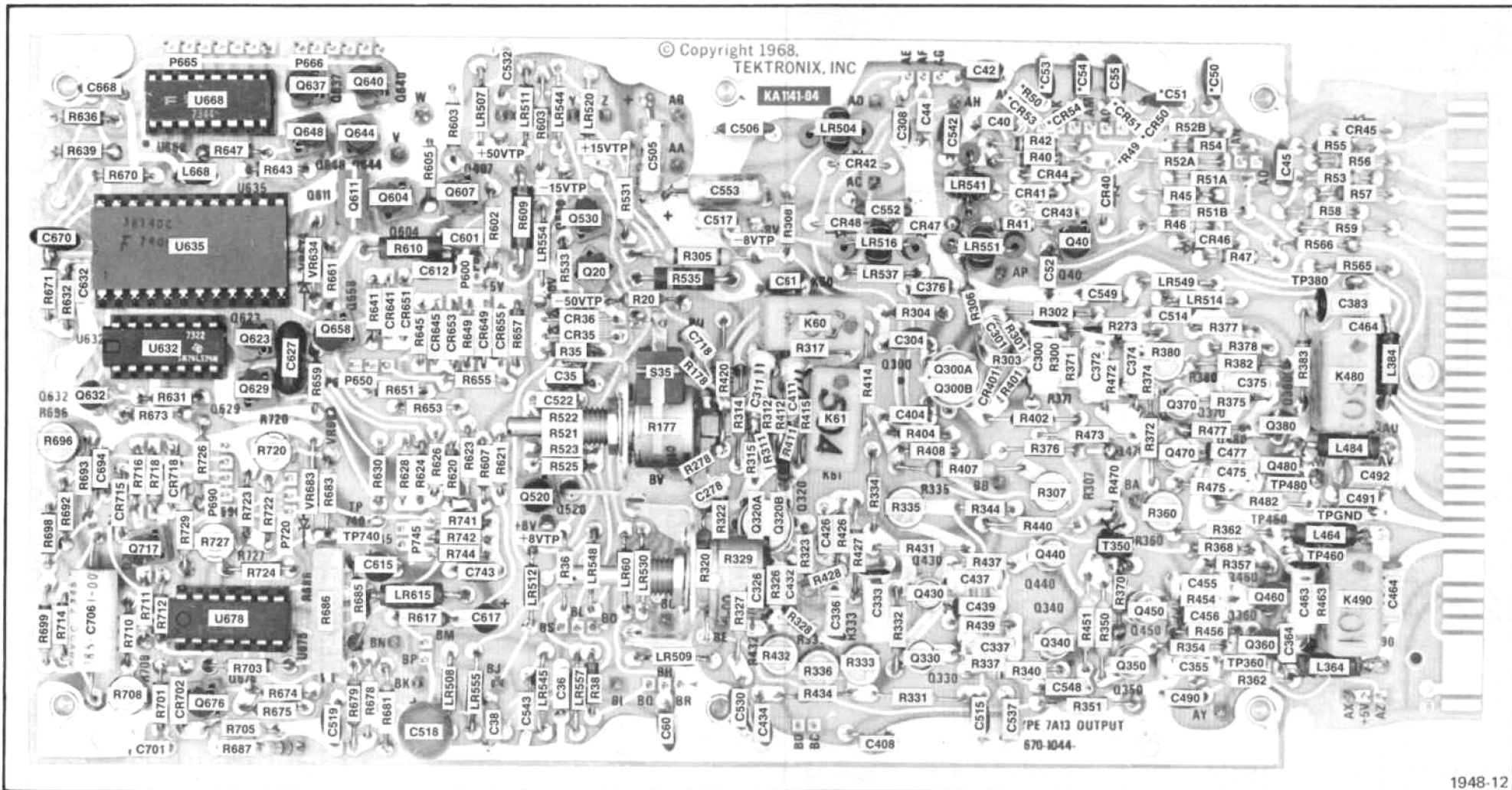
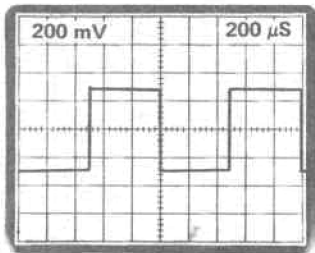

Fig. 7-3. Output Amplifier circuit board component locations SN B200000-up.

REV. A SEP 1976

*See Parts List for serial number ranges.

1



2

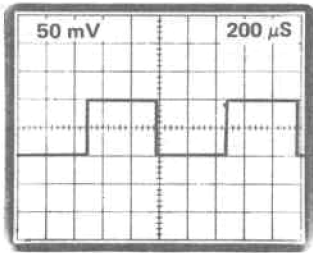

3

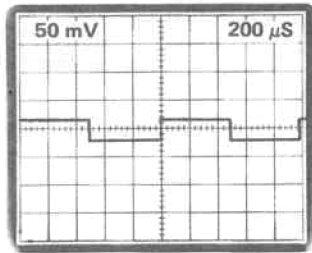

4

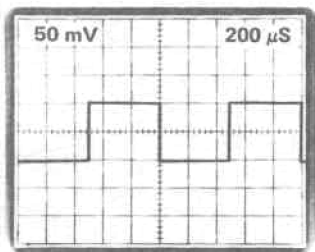

5

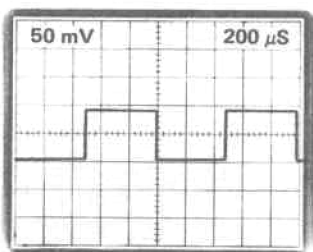

6

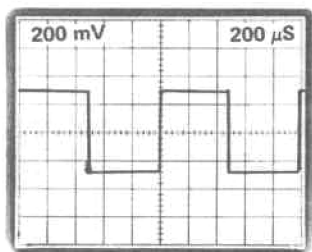

7

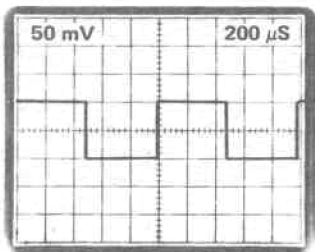

8

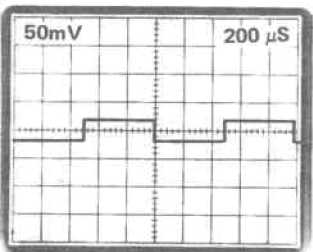

9

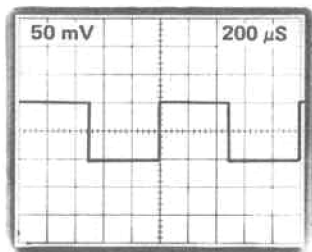

10

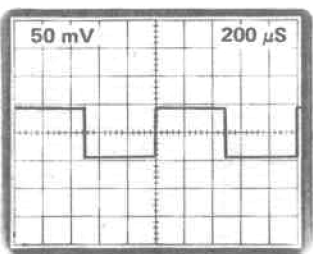

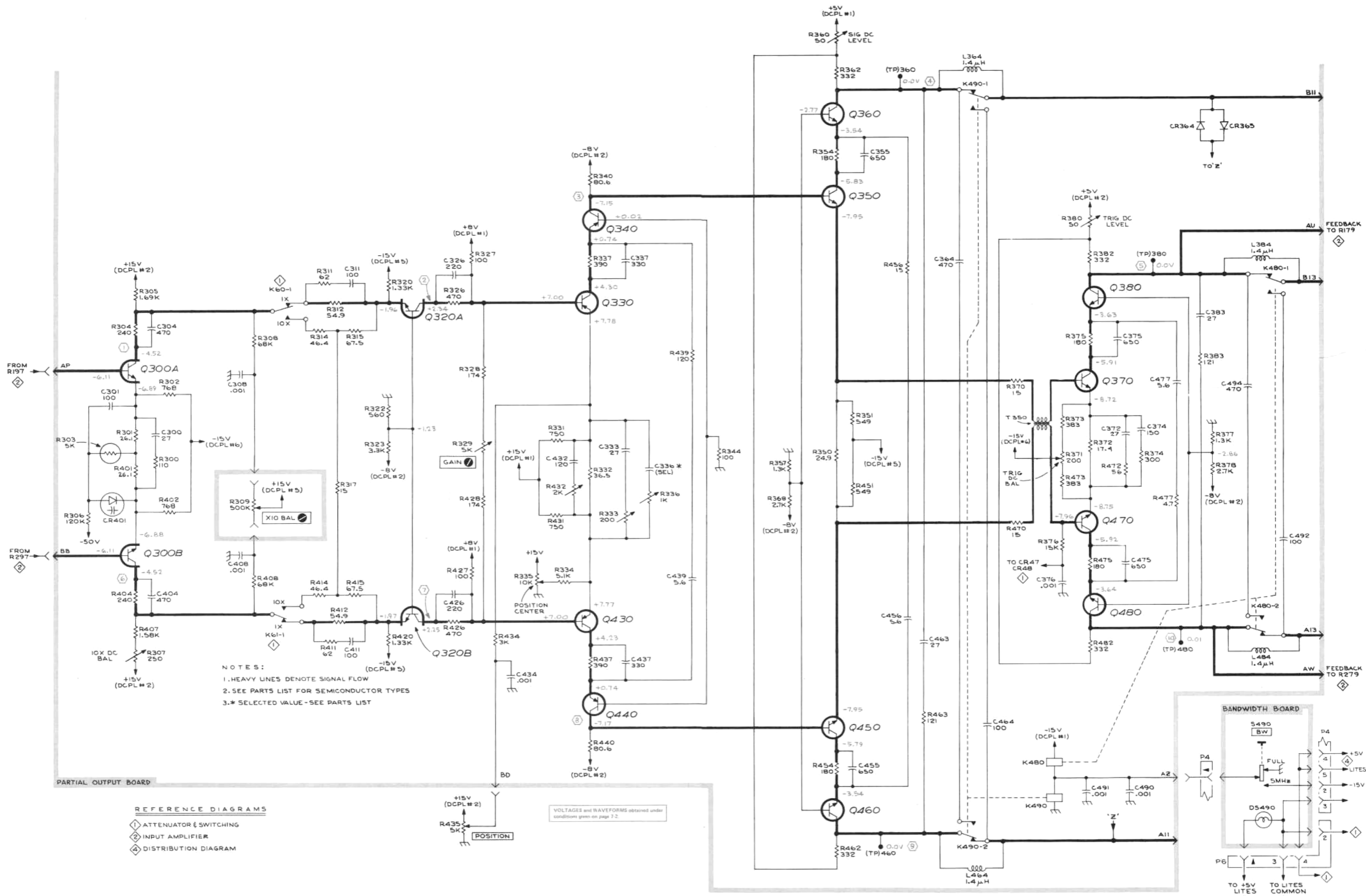

NOTES:
 1. HEAVY LINES DENOTE SIGNAL FLOW
 2. SEE PARTS LIST FOR SEMICONDUCTOR TYPES
 3. * SELECTED VALUE - SEE PARTS LIST

REFERENCE DIAGRAMS

- ① ATTENUATOR & SWITCHING
- ② INPUT AMPLIFIER
- ③ DISTRIBUTION DIAGRAM

VOLTAGES and WAVEFORMS obtained under conditions given on page 7.2.

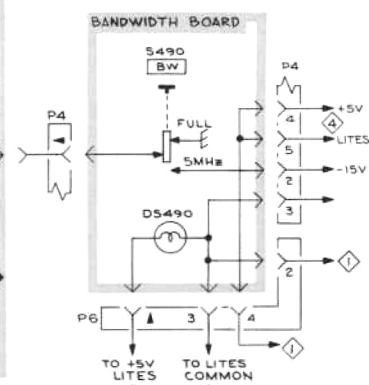
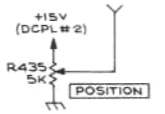

OUTPUT AMPLIFIER ③ GR5
 SN B200000-UP

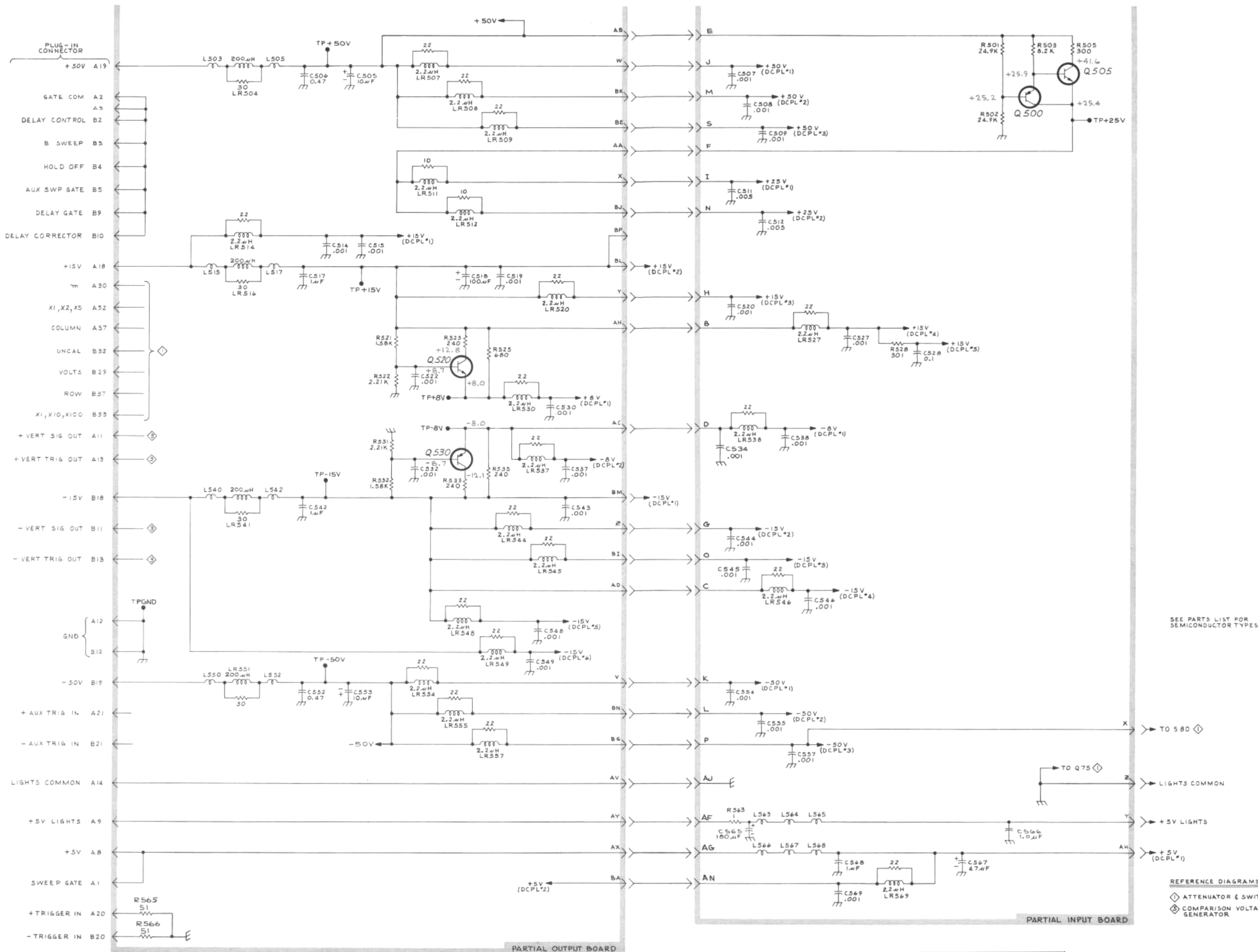

SEE PARTS LIST FOR SEMICONDUCTOR TYPES

REFERENCE DIAGRAMS
 Ⓢ ATTENUATOR & SWITCHING
 Ⓢ COMPARISON VOLTAGE GENERATOR

VOLTAGES and WAVEFORMS obtained under conditions given on page 7.2.

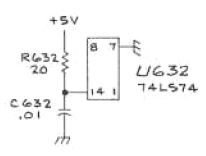
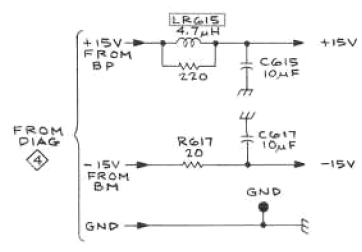
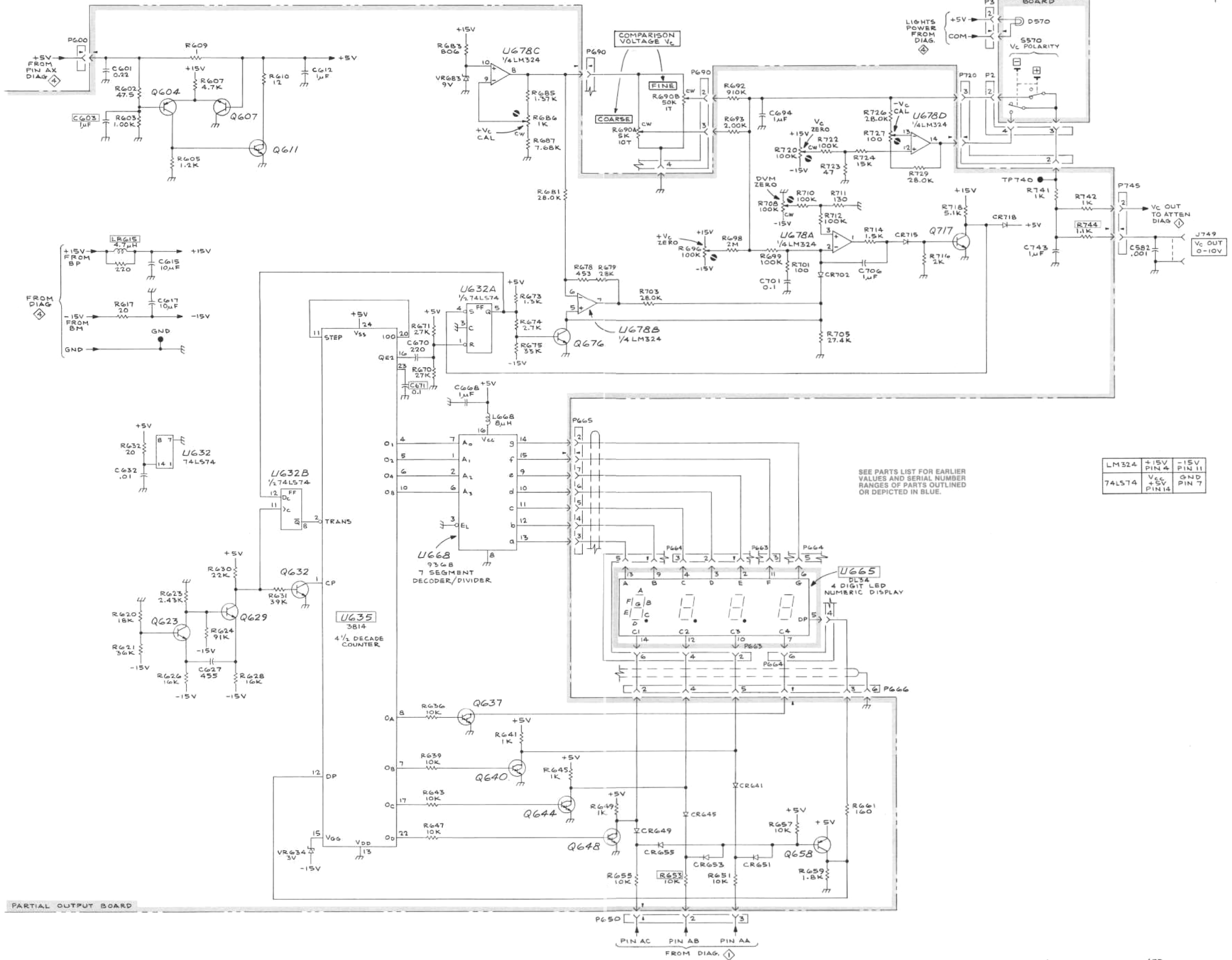

SEE PARTS LIST FOR EARLIER VALUES AND SERIAL NUMBER RANGES OF PARTS OUTLINED OR DEPICTED IN BLUE.

LM324	+5V PIN 4	-15V PIN 11
74LS74	Vcc +5V PIN 14	GND PIN 7

PARTIAL OUTPUT BOARD

REPLACEABLE MECHANICAL PARTS

PARTS ORDERING INFORMATION

Replacement parts are available from or through your local Tektronix, Inc. Field Office or representative.

Changes to Tektronix instruments are sometimes made to accommodate improved components as they become available, and to give you the benefit of the latest circuit improvements developed in our engineering department. It is therefore important, when ordering parts, to include the following information in your order: Part number, instrument type or number, serial number, and modification number if applicable.

If a part you have ordered has been replaced with a new or improved part, your local Tektronix, Inc. Field Office or representative will contact you concerning any change in part number.

Change information, if any, is located at the rear of this manual.

SPECIAL NOTES AND SYMBOLS

X000 Part first added at this serial number
00X Part removed after this serial number

FIGURE AND INDEX NUMBERS

Items in this section are referenced by figure and index numbers to the illustrations.

INDENTATION SYSTEM

This mechanical parts list is indented to indicate item relationships. Following is an example of the indentation system used in the description column.

```

1 2 3 4 5           Name & Description
Assembly and/or Component
Attaching parts for Assembly and/or Component
    - - - * - - -
Detail Part of Assembly and/or Component
Attaching parts for Detail Part
    - - - * - - -
Parts of Detail Part
Attaching parts for Parts of Detail Part
    - - - * - - -
  
```

Attaching Parts always appear in the same indentation as the item it mounts, while the detail parts are indented to the right. Indented items are part of, and included with, the next higher indentation. The separation symbol - - - * - - - indicates the end of attaching parts.

Attaching parts must be purchased separately, unless otherwise specified.

ITEM NAME

In the Parts List, an Item Name is separated from the description by a colon (:). Because of space limitations, an Item Name may sometimes appear as incomplete. For further Item Name identification, the U.S. Federal Cataloging Handbook H6-1 can be utilized where possible.

ABBREVIATIONS

"	INCH	ELCTRN	ELECTRON	IN	INCH	SE	SINGLE END
#	NUMBER SIZE	ELEC	ELECTRICAL	INCAND	INCANDESCENT	SECT	SECTION
ACTR	ACTUATOR	ELCTLT	ELECTROLYTIC	INSUL	INSULATOR	SEMICOND	SEMICONDUCTOR
ADPTR	ADAPTER	ELEM	ELEMENT	INTL	INTERNAL	SHLD	SHIELD
ALIGN	ALIGNMENT	EPL	ELECTRICAL PARTS LIST	LPHLDR	LAMPHOLDER	SHLDR	SHOULDERED
AL	ALUMINUM	EOPT	EQUIPMENT	MACH	MACHINE	SKT	SOCKET
ASSEM	ASSEMBLED	EXT	EXTERNAL	MECH	MECHANICAL	SL	SLIDE
ASSY	ASSEMBLY	FIL	FILLISTER HEAD	MTG	MOUNTING	SLFLKG	SELF-LOCKING
ATTEN	ATTENUATOR	FLEX	FLEXIBLE	NIP	NIPPLE	SLVG	SLEEVING
AWG	AMERICAN WIRE GAGE	FLH	FLAT HEAD	NON WIRE	NOT WIRE WOUND	SPR	SPRING
BD	BOARD	FLTR	FILTER	OBDD	ORDER BY DESCRIPTION	SQ	SQUARE
BRKT	BRACKET	FR	FRAME or FRONT	OD	OUTSIDE DIAMETER	SST	STAINLESS STEEL
BRS	BRASS	FSTNR	FASTENER	OVH	OVAL HEAD	STL	STEEL
BRZ	BRONZE	FT	FOOT	PH BRZ	PHOSPHOR BRONZE	SW	SWITCH
BSHG	BUSHING	FXD	FIXED	PL	PLAIN or PLATE	T	TUBE
CAB	CABINET	GSKT	GASKET	PLSTC	PLASTIC	TERM	TERMINAL
CAP	CAPACITOR	HDL	HANDLE	PN	PART NUMBER	THD	THREAD
CER	CERAMIC	HEX	HEXAGON	PNH	PAN HEAD	THK	THICK
CHAS	CHASSIS	HEX HD	HEXAGONAL HEAD	PWR	POWER	TNSN	TENSION
CKT	CIRCUIT	HEX SOC	HEXAGONAL SOCKET	RCPT	RECEPTACLE	TPG	TAPPING
COMP	COMPOSITION	HLCPS	HELICAL COMPRESSION	RES	RESISTOR	TRH	TRUSS HEAD
CONN	CONNECTOR	HLEXT	HELICAL EXTENSION	RGD	RIGID	V	VOLTAGE
COV	COVER	HV	HIGH VOLTAGE	RLF	RELIEF	VAR	VARIABLE
CPLG	COUPLING	IC	INTEGRATED CIRCUIT	RTNR	RETAINER	W/	WITH
CRT	CATHODE RAY TUBE	ID	INSIDE DIAMETER	SCH	SOCKET HEAD	WSHR	WASHER
DEG	DEGREE	IDENT	IDENTIFICATION	SCOPE	OSCILLOSCOPE	XFMR	TRANSFORMER
DWR	DRAWER	IMPLR	IMPELLER	SCR	SCREW	XSTR	TRANSISTOR

CROSS INDEX—MFR. CODE NUMBER TO MANUFACTURER

Mfr. Code	Manufacturer	Address	City, State, Zip
000BK	STAUFFER SUPPLY	105 SE TAYLOR	PORTLAND, OR 97214
000CY	NORTHWEST FASTENER SALES, INC.	7923 SW CIRRHUS DRIVE	BEAVERTON, OREGON 97005
00779	AMP, INC.	P O BOX 3608	HARRISBURG, PA 17105
01295	TEXAS INSTRUMENTS, INC., SEMICONDUCTOR GROUP	P O BOX 5012, 13500 N CENTRAL EXPRESSWAY	DALLAS, TX 75222
13257	AMERACE, LTD.	10 ESNA PARK DRIVE	MARKHAM, ONTARIO, CANADA
17117	ELECTRONIC MOLDING CORP.	96 MILL ST.	WOONSOCKET, RI 02895
22526	BERG ELECTRONICS, INC.	YOUK EXPRESSWAY	NEW CUMBERLAND, PA 17070
24931	SPECIALTY CONNECTOR CO., INC.	3560 MADISON AVE.	INDIANAPOLIS, IN 46227
28520	HEYMAN MFG. CO.	147 N. MICHIGAN AVE.	KENILWORTH, NJ 07033
70276	ALLEN MFG. CO.	P. O. DRAWER 570	HARTFORD, CT 06101
71785	TRW, CINCH CONNECTORS	1501 MORSE AVENUE	ELK GROVE VILLAGE, IL 60007
73743	FISCHER SPECIAL MFG. CO.	446 MORGAN ST.	CINCINNATI, OH 45206
73803	TEXAS INSTRUMENTS, INC., METALLURGICAL MATERIALS DIV.	34 FOREST STREET	ATTLEBORO, MA 02703
74445	HOLO-KROME CO.	31 BROOK ST. WEST	HARTFORD, CT 06110
76854	OAK INDUSTRIES, INC., SWITCH DIV.	S. MAIN ST.	CRYSTAL LAKE, IL 60014
78189	ILLINOIS TOOL WORKS, INC. SHAKEPROOF DIVISION	ST. CHARLES ROAD	ELGIN, IL 60120
79807	WROUGHT WASHER MFG. CO.	2100 S. O BAY ST.	MILWAUKEE, WI 53207
80009	TEKTRONIX, INC.	P O BOX 500	BEAVERTON, OR 97077
82647	TEXAS INSTRUMENTS, INC., CONTROL PRODUCTS DIV.	34 FOREST ST.	ATTLEBORO, MA 02703
83385	CENTRAL SCREW CO.	2530 CRESCENT DR.	BROADVIEW, IL 60153
86044	CALIFORNIA GASKET COMPANY	1601 W. 134 STREET	GARDENA, CA 90249
86445	PENN FIBRE AND SPECIALTY CO., INC.	2032 E. WESTMORELAND ST.	PHILADELPHIA, PA 19134
86928	SEASTROM MFG. COMPANY, INC.	701 SONORA AVENUE	GLENDALE, CA 91201
87308	N. L. INDUSTRIES, INC., SOUTHERN SCREW DIV.	P. O. BOX 1360	STATESVILLE, NC 28677
88245	LITTON SYSTEMS, INC., USECO DIV.	13536 SATICOY ST.	VAN NUYS, CA 91409
93907	CAMCAR SCREW AND MFG. CO.	600 18TH AVE.	ROCKFORD, IL 61101
98291	SEAELECTRO CORP.	225 HOYT	MAMARONECK, NY 10544

Replaceable Mechanical Parts—7A13 (SN B20000 & up)

Fig. & Index No.	Tektronix Part No.	Serial/Model No. Eff	Dscont	Qty	1	2	3	4	5	Name & Description	Mfr Code	Mfr Part Number
1-1	337-1160-01			1						SHIELD,ELEC:SIDE	80009	337-1160-01
-2	337-1163-01			1						SHLD,ELECTRICAL:RIGHT SIDE	80009	337-1163-01
-3	337-1167-00			1						SHIELD,ELEC:PLASTIC SHEET,2.75 X 4.25"	80009	337-1167-00
-4	366-1189-00			1						KNOB:GRAY	80009	366-1189-00
	213-0153-00			1						. SETSCREW:5-40 X 0.125,STL BK OXD,HEX	000CY	OBD
-5	366-1059-00			1						PUSH BUTTON:GRAY	80009	366-1059-00
-6	366-1077-00			1						KNOB:GRAY	80009	366-1077-00
	213-0020-00			1						. SETSCREW:6-32 X 0.125 INCH,HEX.SOC STL	70276	OBD
-7	366-1058-02			1						KNOB:LATCH	80009	366-1058-02
										(ATTACHING PARTS)		
-8	214-1095-00			1						PIN,SPG,SPLIT:0.094 OD X 0.187 INCH LONG	13257	52-022-094-0187
										- - - * - - -		
-9	105-0076-02			1						REL BAR,LATCH:PLUG-IN UNIT	80009	105-0076-02
-10	214-1280-00			1						SPRING,HLCPS:0.14 OD X 1.126"L,0.16"DIA W	80009	214-1280-00
-11	136-0187-00			1						JACK,TIP:1 CONTACT,BLACK LITE TIGHT	17117	4653-113-0
-12	210-0940-00			1						WASHER,FLAT:0.25 ID X 0.375 INCH OD,STL	79807	OBD
-13	210-0223-00			1						TERMINAL,LUG:0.25 INCH DIA,SE	86928	A313-136
-14	358-0378-00	B200000	B238099	1						BUSHING,SLEEVE:PRESS MOUNT	80009	358-0378-00
	358-0599-00	B238100		1						BUSHING,SLEEVE:0.125 ID X 0.234 THK,PLSTC	28520	B-187-125
-15	358-0301-02			2						BUSHING,SLEEVE:GRAY PLASTIC	80009	358-0301-02
-16	366-1082-00			1						KNOB:GRAY	80009	366-1082-00
	213-0153-00			1						. SETSCREW:5-40 X 0.125,STL BK OXD,HEX	000CY	OBD
-17	366-1123-00			1						KNOB:GRAY	80009	366-1123-00
	213-0153-00			1						. SETSCREW:5-40 X 0.125,STL BK OXD,HEX	000CY	OBD
-18	200-0103-00			1						NUT,PLAIN,KNURL:0.25-28 X 0.375" OD,BRASS	80009	200-0103-00
-19	355-0131-00			1						STUD,BDG POST:GROUND	80009	355-0131-00
-20	366-1084-00			1						KNOB:GRAY	80009	366-1084-00
	213-0153-00			1						. SETSCREW:5-40 X 0.125,STL BK OXD,HEX	000CY	OBD
-21	366-1101-00			1						KNOB:GRAY	80009	366-1101-00
	213-0153-00			1						. SETSCREW:5-40 X 0.125,STL BK OXD,HEX	000CY	OBD
-22	333-1095-02			1						PANEL,FRONT:	80009	333-1095-02
-23	200-0935-00			1						BASE,LAMPHOLDER:0.29 OD X 0.19 CASE	80009	200-0935-00
-24	378-0602-01			1						LENS,LIGHT:AMBER	80009	378-0602-01
-25				1						L.E.D.,READOUT:(SEE U665 EPL)		
	378-0815-01			1						FILTER,LIGHT:RED,0.398 W X 0.868 L	80009	378-0815-01
-26				1						CKT BOARD ASSY:POLARITY(SEE A1 EPL)		
										(ATTACHING PARTS)		
-27	211-0156-00			1						SCREW,MACHINE:1-72 X 0.25",82 DEG,FLH STL	93907	OBD
										- - - * - - -		
										CKT BOARD ASSY INCLUDES:		
-28	131-0589-00			5						. TERM,PIN:0.46 L X 0.025 SQ.PH BRZ GL	22526	47350
-29	337-1041-00			1						SHIELD,ELEC:	80009	337-1041-00
										(ATTACHING PARTS)		
-30	213-0088-00			2						SCR,TPG,THD CTG:4-24 X 0.25 INCH,PNH STL	83385	OBD
										- - - * - - -		
-31	131-0679-02			2						CONNECTOR,RCPT,:BNC,MALE,3 CONTACT	24931	28JR270-1
-32	337-1040-02			1						SHIELD,ELEC:	80009	337-1040-02
										(ATTACHING PARTS)		
-33	213-0055-01			4						SCR,TPG,THD FOR:2-32 X 0.188 INCH,PNH,STL	80009	213-0055-01
										- - - * - - -		
-34	337-1042-00			1						SHIELD,ELEC:	80009	337-1042-00
										(ATTACHING PARTS)		
-35	211-0008-00			2						SCREW,MACHINE:4-40 X 0.25 INCH,PNH STL	83385	OBD
-36	213-0055-01			4						SCR,TPG,THD FOR:2-32 X 0.188 INCH,PNH,STL	80009	213-0055-01
										- - - * - - -		
-37				1						CKT BOARD ASSY:ATTENUATOR(SEE A3 EPL)		
										(ATTACHING PARTS)		
-38	211-0156-00			4						SCREW,MACHINE:1-72 X 0.25",82 DEG,FLH STL	93907	OBD
										- - - * - - -		
										CKT BOARD ASSY INCLUDES:		
-39	131-0608-00			8						. TERMINAL,PIN:0.365 L X 0.25 PH,BRZ,GOLD PL	22526	47357
-40	136-0252-04			38						. SOCKET,PIN TERM:0.188 INCH LONG	22526	75060-007
-41				1						RESISTOR,VAR:(SEE R690A EPL)		
										(ATTACHING PARTS)		
-42	210-0583-00			1						NUT,PLAIN,HEX.:0.25-32 X 0.312 INCH,BRS	73743	2X20224-402
	210-0046-00			1						WASHER,LOCK:INTL,0.26 ID X 0.40" OD,STL	78189	1214-05-00-0541C
										- - - * - - -		

Replaceable Mechanical Parts—7A13 (SN B200000 & up)

Fig. & Index No.	Tektronix Part No.	Serial/Model No. Eff Dscont	Qty	1	2	3	4	5	Name & Description	Mfr Code	Mfr Part Number
1-43	210-1113-00		1						WASHER, FLAT: 0.281 ID X 0.50 OD	86445	OBD
-44	426-0474-00		1						MOUNT, RESILIENT: S SHAPE (ATTACHING PARTS)	80009	426-0474-00
-45	211-0212-00		2						SCREW, MACHINE: 2-56 X 1.75 INCH, PNH STL - - - * - - -	83385	OBD
-46	361-0280-00		4						SPACER, SLEEVE: 0.75 INCH LONG	76854	3-5152-340
-47	376-0039-00		1						ADPT, SHAFT, CPLG: 0.128 AND 0.082" DIA SHAFT	80009	376-0039-00
	213-0075-00		2						. SETSCREW: 4-40 X 0.094 INCH, HEX SOC STL	000BK	OBD
-48	384-1365-00		1						EXTENSION SHAFT: 1.875 INCH LONG	80009	384-1365-00
-49	-----		1						RESISTOR, VAR: (SEE R690B EPL) (ATTACHING PARTS)		
-50	210-0583-00		1						NUT, PLAIN, HEX.: 0.25-32 X 0.312 INCH, BRS	73743	2X20224-402
-51	210-0046-00		1						WASHER, LOCK: INTL, 0.26 ID X 0.40" OD, STL	78189	1214-05-00-0541C
-52	210-0465-00		1						NUT, PLAIN, HEX.: 0.25-32 X 0.375 INCH BRS	73743	3095-402
-53	210-0853-00		1						WASHER, FLAT: 0.25 ID X 0.50 OD - - - * - - -	86044	OBD
-54	386-1095-00		1						PLATE, CMPNT MTG: VAR RESISTOR, STL CD PL	76854	15528-015
-55	200-0609-00		1						BASE, LAMP HOLDER: 0.4 OD X 0.16" L, GRAY PLSTC	80009	200-0609-00
-56	378-0541-00		1						LENS, LIGHT: FROSTED	80009	378-0541-00
-57	352-0084-01		1						HOLDER, NEON:	80009	352-0084-01
-58	-----		1						SWITCH, SLIDE: (SEE S80 EPL) (ATTACHING PARTS)		
-59	220-0464-00		2						NUT, PLAIN, ROUND: 2-56 X 0.156 OD X 0.454 L	80009	220-0464-00
-60	210-0053-00		2						WASHER, LOCK: INTL, 0.092 ID X 0.175" OD, STL - - - * - - -	83385	OBD
-61	384-0701-00		1						EXTENSION SHAFT: (ATTACHING PARTS)	80009	384-0701-00
-62	354-0330-00		2						RING, RETAINING: - - - * - - -	80009	354-0330-00
-63	343-0178-00		1						COLLAR, SHAFT:	80009	343-0178-00
	213-0048-00		1						. SETSCREW: 4-40 X 0.125 INCH, HEX SOC STL	74445	OBD
-64	376-0058-00		1						ARM, SWITCH ACTR:	80009	376-0058-00
-65	376-0039-00		1						ADPT, SHAFT, CPLG: 0.128 AND 0.082" DIA SHAFT	80009	376-0039-00
	213-0048-00		2						. SETSCREW: 4-40 X 0.125 INCH, HEX SOC STL	74445	OBD
-66	-----		1						SWITCH, ROTARY: (SEE S50 EPL) (ATTACHING PARTS)		
-67	210-0405-00		4						NUT, PLAIN, HEX.: 2-56 X 0.188 INCH, BRS	73743	2X12157-402
-68	210-0001-00		4						WASHER, LOCK: INTL, 0.092 ID X 0.18" OD, STL	78189	1202-00-00-0541C
-69	210-0590-00		1						NUT, PLAIN, HEX.: 0.375 X 0.438 INCH, STL	73743	2X28269-402
-70	210-1084-00		1						WASHER, KEY: - - - * - - -	80009	210-1084-00
-71	105-0078-00		1						STOP, ELEC SW: SLIDING, ACETAL	80009	105-0078-00
-72	105-0077-00		1						STOP, ELEC SW: 152 DEG, ACETAL	80009	105-0077-00
	213-0048-00		1						. SETSCREW: 4-40 X 0.125 INCH, HEX SOC STL	74445	OBD
-73	384-0487-00		1						EXTENSION SHAFT: 3.6 INCH LONG, EPOXY-GL	80009	384-0487-00
-74	376-0073-00		1						CPLG HALF, SHAFT: 0.375 INCH OD, PLSTC	80009	376-0073-00
	213-0048-00		1						. SETSCREW: 4-40 X 0.125 INCH, HEX SOC STL	74445	OBD
-75	376-0072-00		1						CPLG HALF, SHAFT: 0.562 INCH OD, PLSTC	80009	376-0072-00
	213-0048-00		1						. SETSCREW: 4-40 X 0.125 INCH, HEX SOC STL	74445	OBD
-76	384-0488-00		1						EXTENSION SHAFT: 0.70 INCH LONG	80009	384-0488-00
-77	376-0029-00		1						CPLG, SHAFT, RGD: 0.128 ID X 0.312 OD X 0.5" L	80009	376-0029-00
	213-0075-00		2						. SETSCREW: 4-40 X 0.094 INCH, HEX SOC STL	000BK	OBD
-78	384-0700-00		1						EXTENSION SHAFT: 0.123 OD X 6.3 INCHES LONG	80009	384-0700-00
-79	376-0051-00		1						CPLG, SHAFT, FLEX: FOR 0.125 INCH DIA SHAFTS	80009	376-0051-00
	213-0048-00		4						. SETSCREW: 4-40 X 0.125 INCH, HEX SOC STL	74445	OBD
-80	-----		1						RESISTOR, VAR: (SEE R435, S40 EPL) (ATTACHING PARTS)		
-81	210-0583-00		1						NUT, PLAIN, HEX.: 0.25-32 X 0.312 INCH, BRS	73743	2X20224-402
-82	210-0046-00		1						WASHER, LOCK: INTL, 0.26 ID X 0.40" OD, STL - - - * - - -	78189	1214-05-00-0541C
-83	-----		1						RESISTOR, VAR: (SEE R309 EPL)		
-84	210-0046-00		1						WASHER, LOCK: INTL, 0.26 ID X 0.40" OD, STL	78189	1214-05-00-0541C

Replaceable Mechanical Parts—7A13 (SN B200000 & up)

Fig. & Index No.	Tektronix Part No.	Serial/Model No. Eff	Dscont	Qty	1 2 3 4 5	Name & Description	Mfr Code	Mfr Part Number
1-85	129-0213-00			1		POST, ELEC-MECH: (ATTACHING PARTS)	80009	129-0213-00
-86	358-0409-00			1		BSHG, MACH. THD: 0.25-32 X 0.159 ID X 0.24 - - - * - - -	80009	358-0409-00
-87	-----			1		RESISTOR, VAR: (SEE R287 EPL)		
-88	210-0046-00			1		WASHER, LOCK: INTL, 0.26 ID X 0.40" OD, STL	78189	1214-05-00-0541C
-89	210-0471-00			1		NUT, SLEEVE: HEX., 0.312 X 0.594 INCH LONG (ATTACHING PARTS)	80009	210-0471-00
-90	358-0409-00			1		BSHG, MACH. THD: 0.25-32 X 0.159 ID X 0.24 - - - * - - -	80009	358-0409-00
-91	-----			1		CKT BOARD ASSY: BANDWIDTH (SEE A2 EPL) (ATTACHING PARTS)		
-92	211-0156-00			1		SCREW, MACHINE: 1-72 X 0.25", 82 DEG, FLH STL - - - * - - -	93907	OBD
-93	131-0589-00			4		. CKT BOARD ASSY INCLUDES: . TERM, PIN: 0.46 L X 0.025 SQ. PH BRZ GL	22526	47350
	131-0590-00			5		. CONTACT, ELEC: 0.71 INCH LONG	22526	47351
-94	-----			1		RESISTOR, VAR: (SEE R175 EPL) (ATTACHING PARTS)		
-95	210-0583-00			2		NUT, PLAIN, HEX.: 0.25-32 X 0.312 INCH, BRS	73743	2X20224-402
-96	210-0046-00			1		WASHER, LOCK: INTL, 0.26 ID X 0.40" OD, STL - - - * - - -	78189	1214-05-00-0541C
-97	348-0235-00			1		SHLD GSKT, ELEC: 4.734 INCH LONG	80009	348-0235-00
-98	386-1447-80			1		SUBPANEL, FRONT: (ATTACHING PARTS)	80009	386-1447-80
-99	213-0192-00			4		SCR, TPG, THD FOR: 6-32 X 0.50 INCH, PNH STL - - - * - - -	87308	OBD
-100	348-0171-00			1		GROMMET, PLASTIC: U-SHAPED	80009	348-0171-00
-101	-----			1		CKT BOARD ASSY: INPUT (SEE A5 EPL) (ATTACHING PARTS)		
-102	211-0155-00			6		SCREW, EXT, RLV B: 4-40 X 0.375 INCH, SST - - - * - - -	80009	211-0155-00
-103	361-0238-00			6		. CKT BOARD ASSY INCLUDES: . SPACER, SLEEVE: 0.25 OD X 0.34 INCH LONG	80009	361-0238-00
-104	131-0182-00	B010100	B209999	2		. TERM, FEEDTHRU: 0.538 L X 0.092 DIA, BRASS	88245	421457-9
-105	358-0136-00	B010100	B209999	2		INSULATOR, BSHG:	88245	420971
	131-0157-00	B210000		2		. TERMINAL, PIN: 0.25 L X 0.040D, BRS	98291	013-1001-000-479
-106	136-0323-00			2		. SKT, PL-IN ELEC:	80009	136-0323-00
-107	200-0945-00			1		. COVER, HALF XSTR: FOR DUAL TO-18 CASE	80009	200-0945-00
-108	200-0945-01			1		. COVER, HALF XSTR: FOR DUAL TO-18 CS, 2-56 THD (ATTACHING PARTS)	80009	200-0945-01
-109	211-0062-00			1		. SCREW, MACHINE: 2-56 X 0.312 INCH, RDH STL - - - * - - -	83385	OBD
-110	214-0781-00			2		. INS, CKT BD MTG:	80009	214-0781-00
-111	131-0589-00			16		. TERM, PIN: 0.46 L X 0.025 SQ. PH BRZ GL	22526	47350
-112	352-0044-00			1		. HOLDER, COIL FORM: (ATTACHING PARTS)	80009	352-0044-00
-113	211-0008-00			2		. SCREW, MACHINE: 4-40 X 0.25 INCH, PNH STL - - - * - - -	83385	OBD
-114	214-1121-00			1		. HEAT SINK, ELEC:	80009	214-1121-00
-115	385-0149-00			1		. SPACER, POST: 0.625 L W/4-40 THD EA END, NYL (ATTACHING PARTS)	80009	385-0149-00
-116	211-0097-00			1		. SCREW, MACHINE: 4-40 X 0.312 INCH, PNH STL - - - * - - -	83385	OBD
-117	214-0579-00			1		. TERM, TEST POINT: BRS CD PL	80009	214-0579-00
-118	136-0183-00			3		. SOCKET, PLUG-IN: 3 PIN, ROUND	80009	136-0183-00
-119	136-0220-00			32		. SOCKET, PLUG-IN: 3 PIN, SQUARE	71785	133-23-11-034
-120	136-0252-04			66		. SOCKET, PIN TERM: 0.188 INCH LONG	22526	75060-007
-121	136-0263-03	B010100	B143849	27		. SOCKET, PIN TERM: FOR 0.025 INCH SQUARE PIN	00779	86250-2
	136-0263-04	B143850		27		. SOCKET, PIN TERM: FOR 0.025 INCH SQUARE PIN	22526	48059
-122	136-0337-00			2		. SOCKET, PLUG-IN: 8 PIN RELAY	80009	136-0337-00
-123	388-1195-03			1		CKT BOARD ASSY: RF SHIELD	80009	388-1195-03
-124	129-0461-00			1		. POST, PRESS MT: 0.163 LONG	80009	129-0461-00

Replaceable Mechanical Parts--7A13 (SN B200000 & up)

Fig. & Index No.	Tektronix Part No.	Serial/Model No. Eff Dscont	Qty	1 2 3 4 5	Name & Description	Mfr Code	Mfr Part Number
1-125	361-0307-00		12		SPACER,SLEEVE:0.125 INCH LONG	80009	361-0307-00
-126	220-0547-01		6		NUT,BLOCK:0.38 X 0.25 X 0.282"OA (ATTACHING PARTS FOR EACH)	80009	220-0547-01
-127	211-0007-00		1		SCREW,MACHINE:4-40 X 0.188 INCH,PNH STL	83385	OBD
-128	211-0105-00		1		SCREW,MACHINE:4-40 X 0.188"100 DEG,FLH STL	83385	OBD
-129	-----		1		CKT BOARD ASSY:OUTPUT(SEE A4 EPL) (ATTACHING PARTS)		
-130	211-0007-00		1		SCREW,MACHINE:4-40 X 0.188 INCH,PNH STL	83385	OBD
-131	-----		-		. CKT BOARD ASSY INCLUDES:		
-132	210-0583-00		1		. RESISTOR,VAR:(SEE R177,S35 EPL) (ATTACHING PARTS)		
-133	210-0046-00		1		. NUT,PLAIN,HEX.:0.25-32 X 0.312 INCH,BRS	73743	2X20224-402
-134	-----		1		. WASHER,LOCK:INTL,0.26 ID X 0.40" OD,STL	78189	1214-05-00-0541C
-134	210-0583-00		1		. RESISTOR,VAR:(SEE R329 EPL) (ATTACHING PARTS)		
-136	210-0046-00		1		. NUT,PLAIN,HEX.:0.25-32 X 0.312 INCH,BRS	73743	2X20224-402
-137	407-0580-00		1		. WASHER,LOCK:INTL,0.26 ID X 0.40" OD,STL	78189	1214-05-00-0541C
-138	407-0581-00		1		. BRACKET,CKT BD:BRASS CD PL	80009	407-0580-00
-139	131-0608-00		49		. BRACKET,CKT BD:BRASS CD PL	80009	407-0581-00
-140	200-1167-00		1		. TERMINAL,PIN:0.365 L X 0.25 PH,BRZ,GOLD PL	22526	47357
-141	136-0220-00		15		. COVER,XSTR:TEMP STAB FOR 2 TO-18 CS STYLE	80009	200-1167-00
-142	131-0590-00		27		. SOCKET,PLUG-IN:3 PIN,SQUARE	71785	133-23-11-034
-143	136-0252-04		3		. CONTACT,ELEC:0.71 INCH LONG	22526	47351
-144	136-0336-00		2		. SOCKET,PIN TERM:0.188 INCH LONG	22526	75060-007
-145	136-0337-00		2		. CONTACT,ELEC:FOR 0.02 INCH DIAMETER PIN	00779	50462-7
-146	214-0579-00		1		. SOCKET,PLUG-IN:5 PIN	80009	136-0336-00
-147	136-0260-02		2		. SOCKET,PLUG-IN:8 PIN RELAY	80009	136-0337-00
-148	136-0269-02		1		. TERM,TEST POINT:BRS CD PL	80009	214-0579-00
-149	136-0578-00		1		. SOCKET,PLUG-IN:16 CONTACT,LOW CLEARANCE	82647	C9316-18
-150	386-1402-00		1		. SOCKET,PLUG-IN:14 CONTACT,LOW CLEARANCE	01295	C95140
-151	213-0192-00		4		. SOCKET,PLUG-IN:24 DIP,LOW PROFILE	73803	CS9002-24
-152	361-0326-00		1		PANEL,REAR: (ATTACHING PARTS)	80009	386-1402-00
-153	407-0493-00		1		SCR,TPG,THD FOR:6-32 X 0.50 INCH,PNH STL	87308	OBD
-154	211-0101-00		3		SPACER,SLEEVE:0.18 ID X 0.25 OD X 0.10"L	80009	361-0326-00
-155	210-0586-00		3		BRACKET,GUIDE:CENTER,ALUMINUM (ATTACHING PARTS)	80009	407-0493-00
-156	214-1054-00		1		SCREW,MACHINE:4-40 X 0.25" 100 DEG,FLH STL	83385	OBD
-157	105-0075-00		1		NUT,PLAIN,EXT W:4-40 X 0.25 INCH,STL	78189	211-041800-00
-158	214-1061-00		1		SPRING,FLAT:0.825 X 0.322,SST	80009	214-1054-00
-159	426-0499-01		1		BOLT,LATCH:7A & 7B SER PL-IN	80009	105-0075-00
-160	426-0505-01		1		SPRING,GROUND:FLAT	80009	214-1061-00
-161	179-1430-02		1		FR SECT,PLUG-IN:BOTTOM	80009	426-0499-01
-162	131-0707-00		1		FR SECT,PLUG-IN:TOP	80009	426-0505-01
-163	352-0161-00		5		WIRING HARNESS,:MAIN	80009	179-1430-02
-164	352-0162-00		2		. CONNECTOR,TERM.:22-26 AWG,BRS& CU BE GOLD	22526	47439
-165	352-0163-00		1		. CONNECTOR,TERM.:22-26 AWG,BRS& CU BE GOLD	22526	46231
-166	352-0164-00		6		. HLDR,TERM CONN:3 WIRE BLACK	80009	352-0161-00
-167	352-0171-00		9		. HLDR,TERM CONN:4 WIRE BLACK	80009	352-0162-00
198-1997-00			1		. CONN BODY,PL,EL:5 WIRE BLACK	80009	352-0163-00
131-0707-00			25		. CONN BODY,PL,EL:6 WIRE BLACK	80009	352-0164-00
352-0164-04			1		. HLDR,TERM CONN:1 WIRE BLACK	80009	352-0171-00
352-0164-03			1		WIRE KIT,ELEC:	80009	198-1997-00
352-0164-06			1		. CONNECTOR,TERM.:22-26 AWG,BRS& CU BE GOLD	22526	47439
-168	352-0165-05		1		. CONN BODY,PL,EL:6 WIRE YELLOW	80009	352-0164-04
			1		. CONN BODY,PL,EL:6 WIRE ORANGE	80009	352-0164-03
			1		. CONN BODY,PL,EL:6 WIRE BLUE	80009	352-0164-06
			1		. CONN BODY,PL,EL:7 WIRE GREEN	80009	352-0165-05

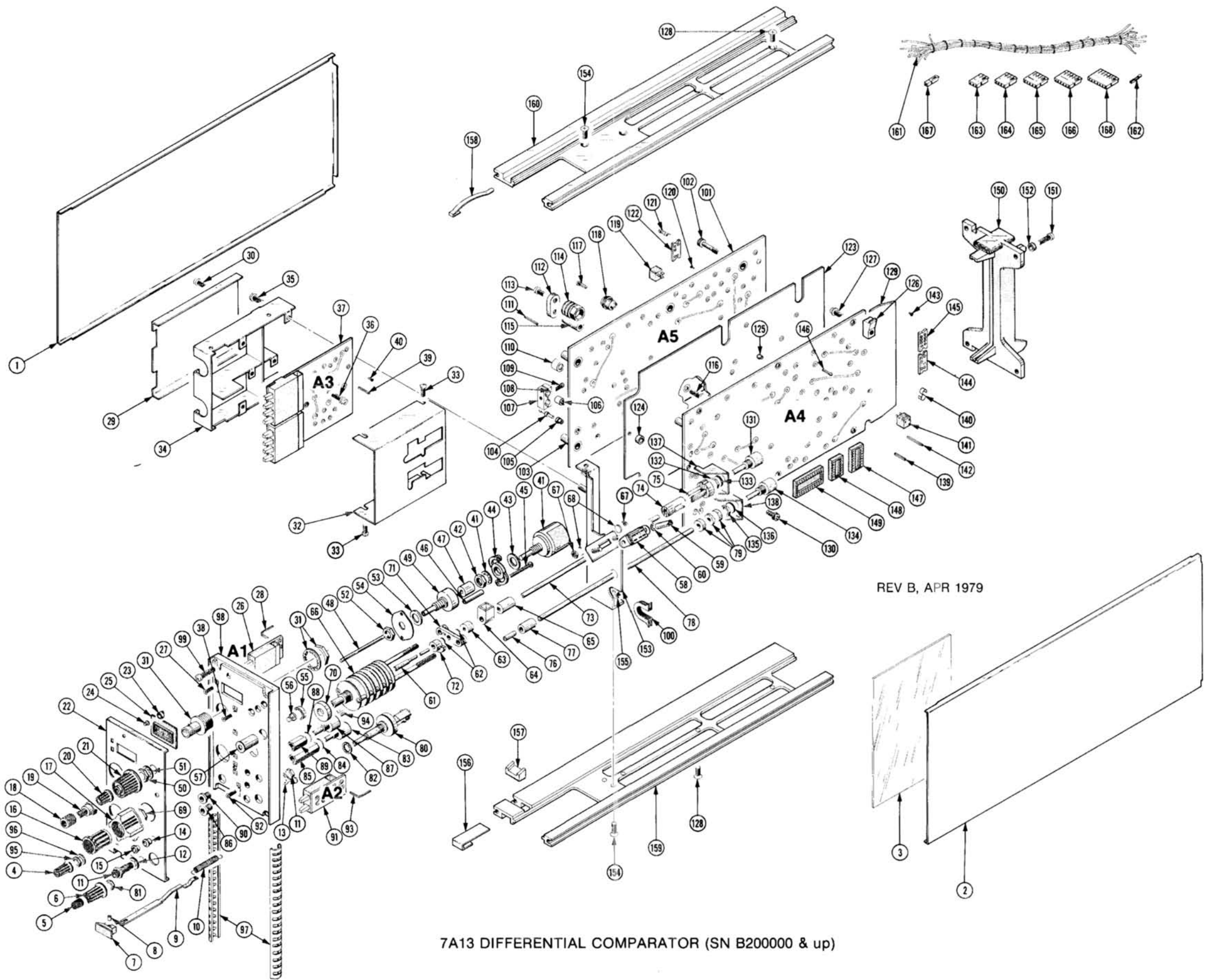

REV B, APR 1979

7A13 DIFFERENTIAL COMPARATOR (SN B20000 & up)

Fig. & Index No.	Tektronix Part No.	Serial/Model No. Eff.	No. Dscont	Qty						Name & Description	Mfr Code	Mfr Part Number
					1	2	3	4	5			
	070-1948-00			1						MANUAL, TECH: INSTRUCTION	80009	070-1948-00

MANUAL CHANGE INFORMATION

At Tektronix, we continually strive to keep up with latest electronic developments by adding circuit and component improvements to our instruments as soon as they are developed and tested.

Sometimes, due to printing and shipping requirements, we can't get these changes immediately into printed manuals. Hence, your manual may contain new change information on following pages.

A single change may affect several sections. Since the change information sheets are carried in the manual until all changes are permanently entered, some duplication may occur. If no such change pages appear following this page, your manual is correct as printed.

SERVICE NOTE

Because of the universal parts procurement problem, some electrical parts in your instrument may be different from those described in the Replaceable Electrical Parts List. The parts used will in no way alter or compromise the performance or reliability of this instrument. They are installed when necessary to ensure prompt delivery to the customer. Order replacement parts from the Replaceable Electrical Parts List.

CALIBRATION TEST EQUIPMENT REPLACEMENT

Calibration Test Equipment Chart

This chart compares TM 500 product performance to that of older Tektronix equipment. Only those characteristics where significant specification differences occur, are listed. In some cases the new instrument may not be a total functional replacement. Additional support instrumentation may be needed or a change in calibration procedure may be necessary.

Comparison of Main Characteristics

DM 501 replaces 7D13		
PG 501 replaces 107 108	PG 501 - Risetime less than 3.5 ns into 50 Ω. PG 501 - 5 V output pulse; 3.5 ns Risetime	107 - Risetime less than 3.0 ns into 50 Ω. 108 - 10 V output pulse 1 ns Risetime
PG 502 replaces 107 108 111	PG 502 - 5 V output PG 502 - Risetime less than 1 ns; 10 ns Pretrigger pulse delay	108 - 10 V output 111 - Risetime 0.5 ns; 30 to 250 ns Pretrigger pulse delay
PG 508 replaces 114 115 2101	Performance of replacement equipment is the same or better than equipment being replaced.	
PG 506 replaces 106 067-0502-01	PG 506 - Positive-going trigger output signal at least 1 V; High Amplitude output, 60 V. PG 506 - Does not have chopped feature.	106 - Positive and Negative-going trigger output signal, 50 ns and 1 V; High Amplitude output, 100 V. 0502-01 - Comparator output can be alternately chopped to a reference voltage.
SG 503 replaces 190, 190A, 190B 191 067-0532-01	SG 503 - Amplitude range 5 mV to 5.5 V p-p. SG 503 - Frequency range 250 kHz to 250 MHz.	190B - Amplitude range 40 mV to 10 V p-p. 0532-01 - Frequency range 65 MHz to 500 MHz.
SG 504 replaces 067-0532-01 067-0650-00	SG 504 - Frequency range 245 MHz to 1050 MHz.	0532-01 - Frequency range 65 MHz to 500 MHz.
TG 501 replaces 180, 180A 181 184 2901	TG 501 - Trigger output-slaved to marker output from 5 sec through 100 ns. One time-mark can be generated at a time. TG 501 - Trigger output-slaved to market output from 5 sec through 100 ns. One time-mark can be generated at a time. TG 501 - Trigger output-slaved to marker output from 5 sec through 100 ns. One time-mark can be generated at a time.	180A - Trigger pulses 1, 10, 100 Hz; 1, 10, and 100 kHz. Multiple time-marks can be generated simultaneously. 181 - Multiple time-marks 184 - Separate trigger pulses of 1 and 0.1 sec; 10, 1, and 0.1 ms; 10 and 1 μs. 2901 - Separate trigger pulses, from 5 sec to 0.1 μs. Multiple time-marks can be generated simultaneously.

NOTE: All TM 500 generator outputs are short-proof. All TM 500 plug-in instruments require TM 500-Series Power Module.