

J108/J109/J110/MMBFJ108

N-Channel Switch

- This device is designed for digital switching applications where very low on resistance is mandatory.
- Sourced from Process 58.

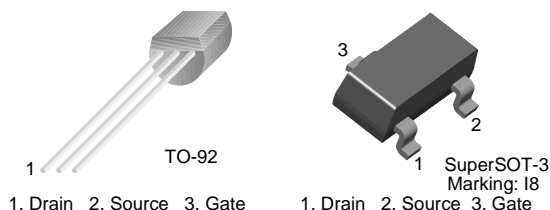

Absolute Maximum Ratings * $T_A=25^\circ\text{C}$ unless otherwise noted

Symbol	Parameter	Value	Units
V_{DG}	Drain-Gate Voltage	25	V
V_{GS}	Gate-Source Voltage	-25	V
I_{GF}	Forward Gate Current	10	mA
T_J, T_{stg}	Operating and Storage Junction Temperature Range	-55 ~ +150	$^\circ\text{C}$

* These ratings are limiting values above which the serviceability of any semiconductor device may be impaired.

NOTES:

- These ratings are based on a maximum junction temperature of 150 degrees C.
- These are steady state limits. The factory should be consulted on applications involving pulsed or low duty cycle operations.

Electrical Characteristics $T_A=25^\circ\text{C}$ unless otherwise noted

Symbol	Parameter	Test Condition	Min.	Max.	Units
Off Characteristics					
$V_{(BR)GSS}$	Gate-Source Breakdown Voltage	$I_G = -10\mu\text{A}, V_{DS} = 0$	-25		V
I_{GSS}	Gate Reverse Current	$V_{GS} = -15\text{V}, V_{DS} = 0$		-3.0	nA
		$V_{GS} = -15\text{V}, V_{DS} = 0, T_A = 100^\circ\text{C}$		-200	nA
$V_{GS(off)}$	Gate-Source Cutoff Voltage	$V_{DS} = 15\text{V}, I_D = 10\text{nA}$			
		108	-3.0	-10	V
		109	-2.0	-6.0	V
		110	-0.5	-4.0	V
On Characteristics					
I_{DSS}	Zero-Gate Voltage Drain Current *	$V_{DS} = 15\text{V}, I_{GS} = 0$			
		108	80		mA
		109	40		mA
		110	10		mA
$r_{DS(on)}$	Drain-Source On Resistance	$V_{DS} \leq 0.1\text{V}, V_{GS} = 0$			
		108		8.0	Ω
		109		12	Ω
		110		18	Ω
Small Signal Characteristics					
$C_{dg(on)}$	Drain Gate & Source Gate On Capacitance	$V_{DS} = 0, V_{GS} = 0, f = 1.0\text{MHz}$		85	pF
$C_{sg(off)}$	Source-Gate Off Capacitance				
$C_{dg(off)}$	Drain-Gate Off Capacitance	$V_{DS} = 0, V_{GS} = -10, f = 1.0\text{MHz}$		15	pF
$C_{sg(off)}$	Source-Gate Off Capacitance	$V_{DS} = 0, V_{GS} = -10, f = 1.0\text{MHz}$		15	pF

* Pulse Test: Pulse Width $\leq 300\mu\text{s}$, Duty Cycle $\leq 2.0\%$

Thermal Characteristics $T_A=25^{\circ}\text{C}$ unless otherwise noted

Symbol	Parameter	Max.		Units
		J108 - 110	*MMBFJ108	
P _D	Total Device Dissipation	625	350	mW
	Derate above 25°C	5.0	2.8	mW/°C
R _{θJC}	Thermal Resistance, Junction to Case	125		°C/W
R _{θJA}	Thermal Resistance, Junction to Ambient	357	556	°C/W

* Device mounted on FR-4 PCB 1.6" × 1.6" × 0.06"

Typical Characteristics

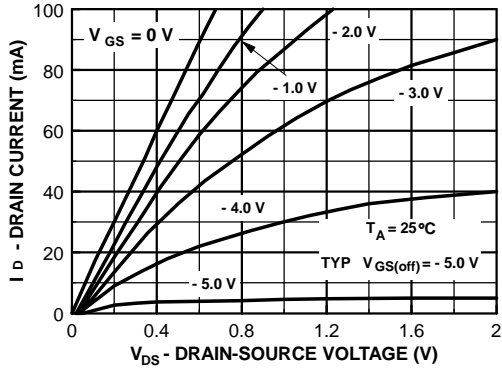

Figure 1. Common Drain-Source

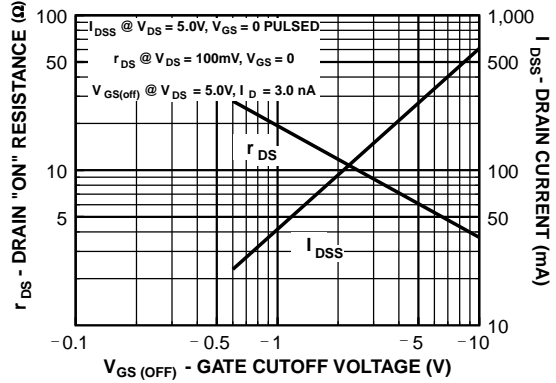

Figure 2. Parameter Interactions

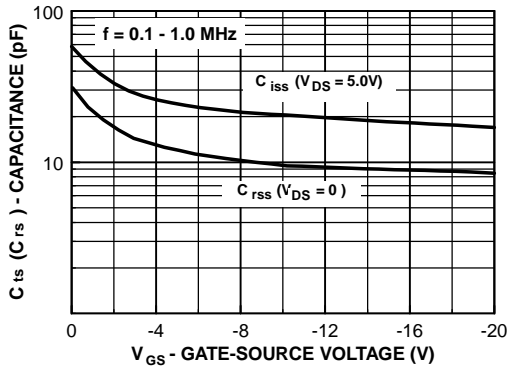

Figure 3. Common Drain-Source

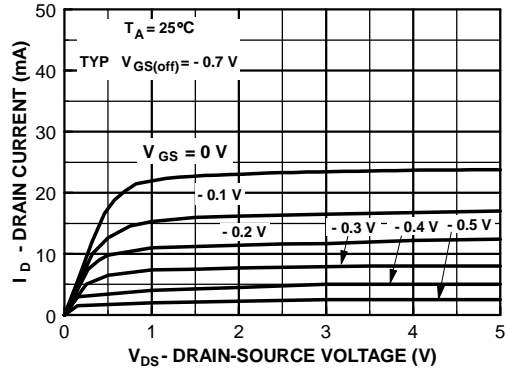

Figure 4. Common Drain-Source

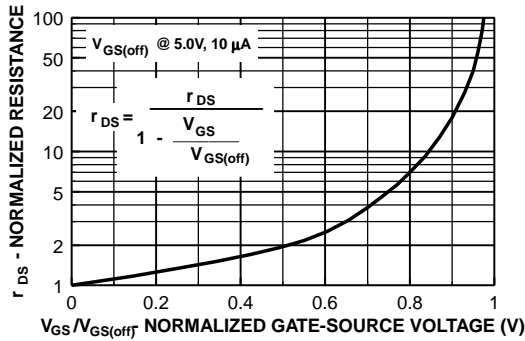

Figure 5. Normalized Drain Resistance vs Bias Voltage

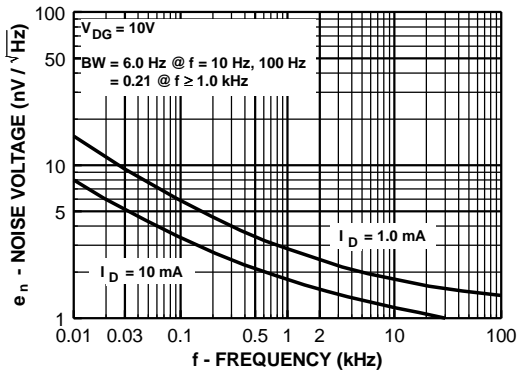

Figure 6. Noise Voltage vs Frequency

Typical Characteristics (Continued)

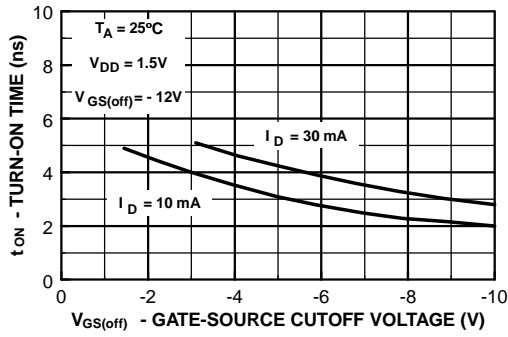

Figure 7. Switching Turn-On Time vs Gate-Source Cutoff Voltage

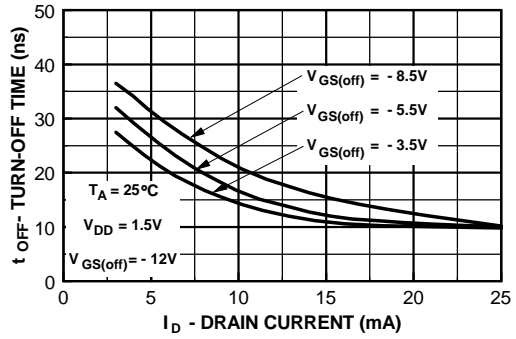

Figure 8. Switching Turn-Off Time vs Drain Current

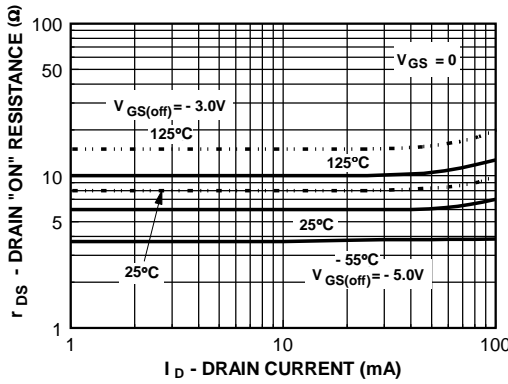

Figure 9. On Resistance vs Drain Current

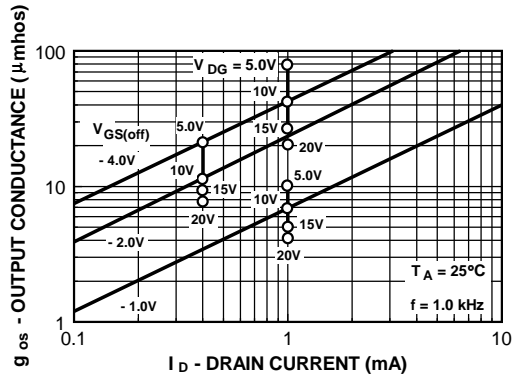

Figure 10. Output Conductance vs Drain Current

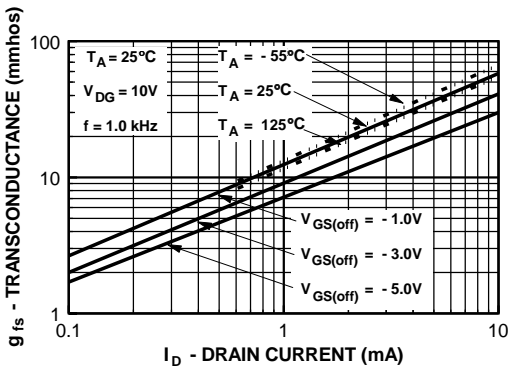

Figure 11. Transconductance vs Drain Current

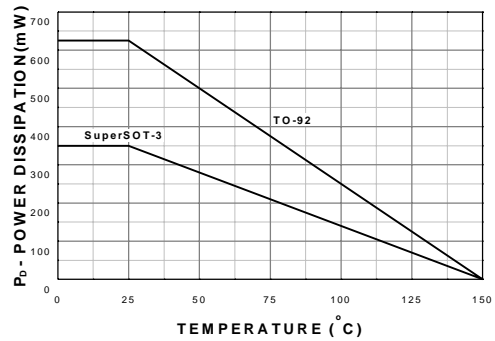
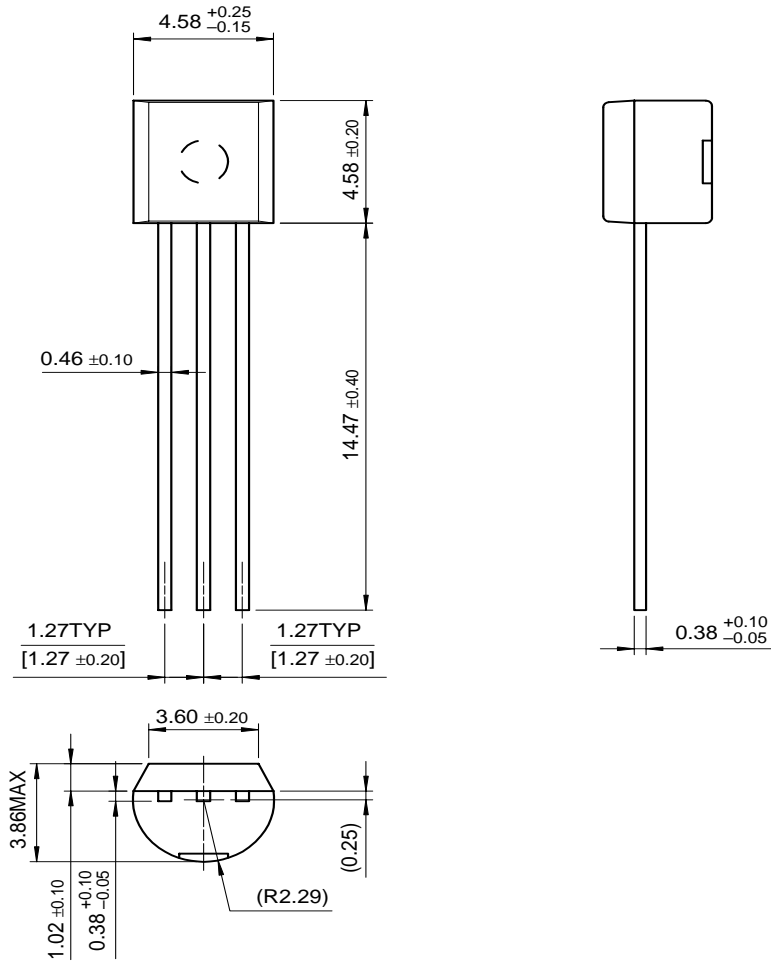

Figure 12. Power Dissipation vs Ambient Temperature

Package Dimensions

TO-92



J108/J109/J110/MMBF-J108

Dimensions in Millimeters

Package Dimensions (Continued)

J108/J109/J110/MMBF-J108

SuperSOT-3

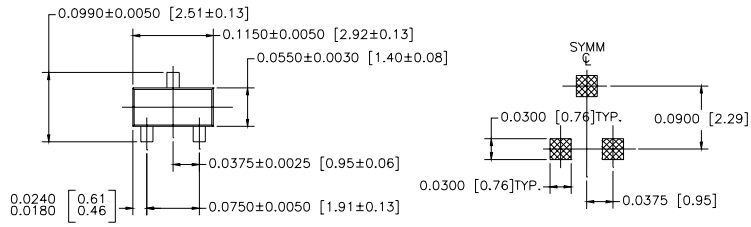

LAND PATTERN RECOMMENDATION

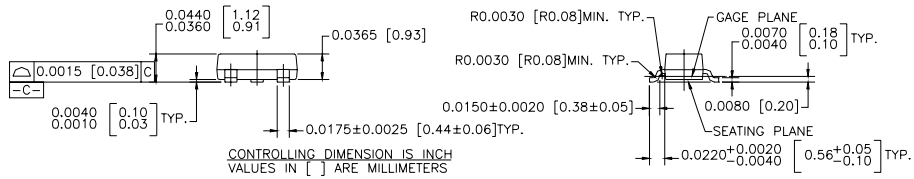

Dimensions in Millimeters

TRADEMARKS

The following are registered and unregistered trademarks Fairchild Semiconductor owns or is authorized to use and is not intended to be an exhaustive list of all such trademarks.

ACE [™]	FACT [™]	ImpliedDisconnect [™]	PACMAN [™]	SPM [™]
ActiveArray [™]	FACT Quiet series [™]	ISOPLANAR [™]	POP [™]	Stealth [™]
Bottomless [™]	FAST [®]	LittleFET [™]	Power247 [™]	SuperSOT [™] -3
CoolFET [™]	FAST [™]	MicroFET [™]	PowerTrench [®]	SuperSOT [™] -6
CROSSVOLT [™]	FRFET [™]	MicroPak [™]	QFET [™]	SuperSOT [™] -8
DOMET [™]	GlobalOptoisolator [™]	MICROWIRE [™]	QS [™]	SyncFET [™]
EcoSPARK [™]	GTO [™]	MSX [™]	QT Optoelectronics [™]	TinyLogic [™]
E ² CMOS [™]	HiSeC [™]	MSXPro [™]	Quiet Series [™]	TruTranslation [™]
EnSigna [™]	I ² C [™]	OCX [™]	RapidConfigure [™]	UHC [™]
Across the board. Around the world. [™]		OCXPro [™]	RapidConnect [™]	UltraFET [®]
The Power Franchise [™]		OPTOLOGIC [®]	SILENT SWITCHER [®]	VCX [™]
Programmable Active Droop [™]		OPTOPLANAR [™]	SMART START [™]	

DISCLAIMER

FAIRCHILD SEMICONDUCTOR RESERVES THE RIGHT TO MAKE CHANGES WITHOUT FURTHER NOTICE TO ANY PRODUCTS HEREIN TO IMPROVE RELIABILITY, FUNCTION OR DESIGN. FAIRCHILD DOES NOT ASSUME ANY LIABILITY ARISING OUT OF THE APPLICATION OR USE OF ANY PRODUCT OR CIRCUIT DESCRIBED HEREIN; NEITHER DOES IT CONVEY ANY LICENSE UNDER ITS PATENT RIGHTS, NOR THE RIGHTS OF OTHERS.

LIFE SUPPORT POLICY

FAIRCHILD'S PRODUCTS ARE NOT AUTHORIZED FOR USE AS CRITICAL COMPONENTS IN LIFE SUPPORT DEVICES OR SYSTEMS WITHOUT THE EXPRESS WRITTEN APPROVAL OF FAIRCHILD SEMICONDUCTOR CORPORATION.

As used herein:

1. Life support devices or systems are devices or systems which, (a) are intended for surgical implant into the body, or (b) support or sustain life, or (c) whose failure to perform when properly used in accordance with instructions for use provided in the labeling, can be reasonably expected to result in significant injury to the user.
2. A critical component is any component of a life support device or system whose failure to perform can be reasonably expected to cause the failure of the life support device or system, or to affect its safety or effectiveness.

PRODUCT STATUS DEFINITIONS

Definition of Terms

Datasheet Identification	Product Status	Definition
Advance Information	Formative or In Design	This datasheet contains the design specifications for product development. Specifications may change in any manner without notice.
Preliminary	First Production	This datasheet contains preliminary data, and supplementary data will be published at a later date. Fairchild Semiconductor reserves the right to make changes at any time without notice in order to improve design.
No Identification Needed	Full Production	This datasheet contains final specifications. Fairchild Semiconductor reserves the right to make changes at any time without notice in order to improve design.
Obsolete	Not In Production	This datasheet contains specifications on a product that has been discontinued by Fairchild semiconductor. The datasheet is printed for reference information only.